



BOOK MOUNT IPC

INSTRUCTIONS FOR USE | C6 P34 BM

Original Manual
Document 20176534 EN 01



Preface

The described hard- and software are developments of the KEB Automation KG. The enclosed documents correspond to conditions valid at printing. Misprint, mistakes and technical changes reserved.

Signal words and symbols

Certain operations can cause hazards during the installation, operation or thereafter. There are safety informations in the documentation in front of these operations. Security signs are located on the device or machine. A warning contains signal words which are explained in the following table:

DANGER	Dangerous situation, which will cause death or serious injury in case of non-observance of this safety instruction.
WARNING	Dangerous situation, which may cause death or serious injury in case of non-observance of this safety instruction.
CAUTION	Dangerous situation, which may cause minor injury in case of non-observance of this safety instruction.
NOTICE	Situation, which can cause damage to property in case of non-observance.

RESTRICTION

Is used when certain conditions must meet the validity of statements or the result is limited to a certain validity range.

	Is used when the result will be better, more economic or trouble-free by following these procedures.
--	--

More symbols

- ▶ This arrow starts an action step.
- / - Enumerations are marked with dots or indents.
- => Cross reference to another chapter or another page.



Note to further documentation.
www.keb.de/nc/search



Laws and guidelines

KEB Automation KG confirms with the EC declaration of conformity and the CE mark on the device nameplate that it complies with the essential safety requirements.

The EC declaration of conformity can be downloaded on demand via our website. Further information is provided in chapter "Certification".

Warranty and liability

The warranty and liability on design, material or workmanship for the acquired device is given in the general sales conditions.



Here you will find our general sales conditions.
www.keb.de/terms-and-conditions



Further agreements or specifications require a written confirmation.

Support

Through multiple applications not every imaginable case has been taken into account. If you require further information or if problems occur which are not treated detailed in the documentation, you can request the necessary information via the local KEB Automation KG agency.

The use of our units in the target products is outside of our control and therefore lies exclusively in the area of responsibility of the customer.

The information contained in the technical documentation, as well as any user-specific advice in spoken and written and through tests, are made to best of our knowledge and information about the intended use. However, they are regarded as being only informal and changes are expressly reserved, in particular due to technical changes. This also applies to any violation of industrial property rights of a third-party. Selection of our units in view of their suitability for the intended use must be done generally by the user.

Tests can only be done within the intended end use of the product (application) by the customer. They must be repeated, even if only parts of hardware, software or the unit adjustment are modified.

Copyright

The customer may use the instructions for use as well as further documents or parts from it for internal purposes. Copyrights are with KEB Automation KG and remain valid in its entirety.

This KEB product or parts thereof may contain third-party software, including free and/or open source software. If applicable, the license terms of this software are contained in the instructions for use. The instructions for use are already available to you, can be downloaded free of charge from the KEB website or can be requested from the respective KEB contact person.

Other wordmarks or/and logos are trademarks (™) or registered trademarks (®) of their respective owners.

Table of Contents

Preface	3
Signal words and symbols	3
More symbols.....	3
Laws and guidelines.....	4
Warranty and liability.....	4
Support	4
Copyright.....	4
Table of Contents	5
List of Figures	8
List of Tables	10
Glossary	11
Standards for control & automation	12
1 Basic Safety Instructions	14
1.1 Target Group.....	14
1.2 Transport, storage and proper use.....	15
1.3 Installation.....	15
1.4 Electrical connection	16
1.5 Start-up and operation.....	16
1.6 Maintenance.....	16
1.8 Repair	17
1.7 Disposal.....	17
2 System Description	18
2.1 Concepts	18
2.2 Highlights	19
2.2.1 Isolated Power Supply	19
2.3 Package.....	20
2.4 Front	20
2.5 Rear.....	21
2.6 D0, D1 version.....	21
2.6.1 Connectors	22
2.6.2 C6 P34 BM S0 - Top Connectors / LED	23
2.6.3 LED Signaling.....	24
2.6.4 Buttons Area.....	25
2.6.5 Power Supply / Screw for functional equipotential bonding	26
2.6.6 Battery CR2032 3V	27
2.6.7 CFast.....	28
2.6.8 Mass storage.....	28
2.6.9 Add-on interface (optional).....	29

2.6.10 Labels position 29

3 Installation and connection 30

3.1 Preparation for installation..... 30
 3.1.1 Select the mounting location 30
3.2 Checking the package contents..... 30
3.3 Checking the operating conditions 30
3.4 Mounting position 30
3.5 Damage due to overheating 30
3.6 Dimensions 31
3.7 Mounting the device..... 32
3.8 Equipotential Grounding and bonding..... 34
 3.8.1 Power supply insulation..... 35
 3.8.2 Wiring diagram 35
 3.8.3 Power connection assembly..... 36
 3.8.4 Power on 38
3.9 Shutdown 38

4 Operating Systems 39

4.1 KEB Windows Images (Windows Embedded Standard 7 / Windows 10)..... 39
 4.1.1 Introduction..... 39
 4.1.2 User Accounts 39
 4.1.3 Ethernet Address..... 39
 4.1.4 Usage of storage memories 40
 4.1.5 Firewall 41
 4.1.6 eGalax Touch Driver..... 42
4.2 Windows Updates..... 43
4.3 EWF implementation in the Windows Embedded Standard 7 images 44
4.4 KEB Write Filter Manager (KEB-WF_MGR) 45
 4.4.1 Introduction..... 45
 4.4.2 How EWF works..... 45
 4.4.3 Protectable Volumes 45
 4.4.4 KEB EWF configuration..... 45
 4.4.5 Delivery state of EWF on KEB devices 46
 4.4.6 Using KEB_WF_Mgr 47
 4.4.7 Dependent Volumes (typically E:\) 49
 4.4.8 Leave the KEB_WF_Mgr..... 50
4.5 KEB UWF Manager 50
 4.5.1 Introduction..... 50
 4.5.2 Functioning of the UWF 50
 4.5.3 KEB UWF Configuration and usage..... 50
4.6 KEB Linux Image 53
 4.6.1 Introduction..... 53

4.6.2 Service User Accounts	53
4.6.3 Change password for service user.....	54
4.6.4 Ethernet IP Address	54
4.6.5 Usage of storage memories	55
4.7 Common (Windows and Linux).....	56
4.7.1 Micro-UPS Handling.....	56
4.7.2 Ip-Scan	57
4.7.3 Serial interface	57
5 Maintenance and service	59
5.1 Removing the left side cover.....	59
5.2 RAM installation / removal.....	59
5.3 Extractable disc installation / removal	61
5.4 Battery installtion / removal	62
5.5 CFast installation / removal.....	63
5.5.1 Removal	64
5.6 Maintaining and cleaning.....	64
5.6.1 Procedure.....	64
5.7 Technical support and repairs	64
5.8 Recycling and disposal.....	65
6 Technical specifications	66
6.1 Block Diagram	66
6.2 C6 P34 BM S0 - Technical data.....	67
6.2.1 Power supply technical data.....	70
6.2.2 System power consumption	71
6.3 Battery technical data	72
7 Certification.....	73
7.1 Mark of conformity	73
7.2 TÜV Certificate.....	75

List of Figures

Figure 1:	Isolated Power Supply	19
Figure 2:	Package	20
Figure 3:	Front detail	20
Figure 4:	Rear detail	21
Figure 5:	D0, D1 version	21
Figure 6:	Connector detail	22
Figure 7:	Top connectors detail	23
Figure 8:	LED signaling detail	24
Figure 9:	Buttons area detail	24
Figure 10:	Buttons area detail	25
Figure 11:	Buttons area detail	25
Figure 12:	Power supply area detail	26
Figure 13:	Screw for functional equipotential bonding	26
Figure 14:	Power supply socket	26
Figure 15:	Battery slot detail	27
Figure 16:	CFast slot detail	28
Figure 17:	Mass storage	28
Figure 18:	Labels position	29
Figure 19:	C6 P34 - dimensions	31
Figure 20:	C6 P34 BM - dimensions	31
Figure 21:	Wall mounting procedure	32
Figure 22:	Wall mounting procedure	32
Figure 23:	Wall mounting procedure	33
Figure 24:	Wall mounting procedure	33
Figure 25:	Power supply diagramm	34
Figure 26:	Power supply diagramm	34
Figure 27:	Grounding detail	35
Figure 28:	Power supply connection detail	35
Figure 29:	Power connector assembly	36
Figure 30:	Power connector assembly	36
Figure 31:	Power connector assembly	36
Figure 32:	Power connector assembly	36
Figure 33:	Cup installation	37
Figure 34:	Cup installation	37
Figure 35:	Cup installation	37
Figure 36:	Power connector assembly	37
Figure 37:	Connecting the ground cables	38
Figure 38:	Power on sequence	38
Figure 39:	Removing the left side cover	59
Figure 40:	RAM installation / removal	59
Figure 41:	RAM installation / removal	60
Figure 42:	RAM installation / removal	60
Figure 43:	Extractable disc installation / removal	61

Figure 44:	Extractable disc installation / removal.....	61
Figure 45:	Extractable disc installation / removal.....	62
Figure 46:	Battery installation / removal.....	62
Figure 47:	Battery installation / removal.....	62
Figure 48:	Battery installation / removal.....	63
Figure 49:	Battery installation / removal.....	63
Figure 50:	CFast installation / removal.....	63
Figure 51:	CFast installation / removal.....	64
Figure 52:	Block diagram	66
Figure 53:	Battery CR2032 detail.....	72
Figure 54:	Battery performance	72

List of Tables

Table 1:	User Accounts.....	39
Table 2:	Volume protection	45
Table 3:	C6 P34 BM S0 - Technical data	68
Table 4:	Options.....	69
Table 5:	Power supply technical data	70
Table 6:	System power consumption.....	71
Table 7:	Battery technical data	72

Glossary

0V	Earth-potential-free common point	KEB product	The KEB product is subject of this manual.
1ph	1-phase mains	KEB-I/O	Small control system from the KEB-I/O system
3ph	3-phase mains	EtherCAT	
AC	AC current or voltage	SPS	
Application	The application is the intended use of the KEB product.	KEB-I/O	I/O module family
ASCL	Asynchronous sensorless closed loop	EtherCAT	
		System	
AWG	American wire gauge	Manufacturer	The manufacturer is KEB, unless otherwise specified (e.g. as manufacturer of machines, engines, vehicles or adhesives).
B2B	Business-to-business	MCM	American unit for large wire cross sections
CAN	Fieldbus system	MTTF	Mean service life to failure
CODESYS	Operating system of the standard control and programming environment	NN	Sea level
CODESYS	Safety programming system	PE	Protective earth
Safety-PS		PELV	Protective Extra Low Voltage
COM-	KEB drive converters	PFD	Term used in the safety technology (EN 61508-1...7) for the size of error probability
BIVERT		PFH	Term used in the safety technology (EN 61508-1...7) for the size of error probability per hour
COMBIVIS	KEB start-up and parameterizing software	PLC	Programmable logic controller
Customer	The customer has purchased a KEB product from KEB and integrates the KEB product into his product (customer product) or resells the KEB product (dealer)	POU	Program Organization Unit
		RJ45	Modular connector with 8 lines
DC	DC current or voltage	Safety Package	Plug in for COMBIVIS studio 6 with safety functionally
DIN	German Institut for standardization	Safety PLC	Safety programmable logic controller
EMC	Electromagnetic compatibility	Safety PLCopen	Library of the certified basic level safety blocks
Emergency stop	Shutdown of a drive in emergency case (not de-energized)	SELV	Safety Extra Low Voltage (<60V)
Emergency	Switching off the voltage supply in switching off emergency case	SIL	The security integrity level is a measure for quantifying the risk reduction. Term used in the safety technology (EN 61508 -1...7)
EN	European standard	USB	Universal serial bus
End customer	The end customer is the user of the customer product.		
EtherCAT	Real-time Ethernet bus system of the company Beckhoff		
Ethernet	Real-time bus system - defines protocols, plugs, types of cables		
FE	Functional earth		
FSoE	Functional Safety over Ethernet		
GND	Reference potential, ground		
Head module	Description for the bus coupler or small control in the KEB-I/O EtherCat system		
HMI	Human machine interface (touch screen)		
IEC	International standard		
IP xx	Degree of protection (xx for level)		

Standards for control & automation

DGUV regulation 3	Electrical installations and equipment
DIN 46228-1	Wire-end ferrules; Tube without plastic sleeve
DIN 46228-4	Wire-end ferrules; Tube with plastic sleeve
DIN IEC 60364-5-54	Low-voltage electrical installations - Part 5-54: Selection and erection of electrical equipment - Earthing arrangements, protective conductors and protective bonding conductors (IEC 64/1610/CD)
DIN VDE 0100-729	Low-voltage electrical installations - Part 7-729: Requirements for special installations or locations - Operating or maintenance gangways (IEC 60364-7-729); German implementation HD 60364-7-729
EN 1037	Safety of machinery - Prevention of unexpected start-up; German version EN 1037
EN 55011	Industrial, scientific and medical equipment - Radio frequency disturbance characteristics - Limits and methods of measurement (IEC/CISPR 11); German version EN 55011
EN 55021	Interference to mobile radiocommunications in the presence of impulse noise - Methods of judging degradation and measures to improve performance (IEC/CISPR/D/230/FDIS); German version prEN 55021
EN 60204-1	Safety of machinery - electrical equipment of machines Part 1: General requirements (VDE 0113-1, IEC 44/709/CDV)
EN 60439-1	Low-voltage switchgear and controlgear assemblies - Part 1: Type-tested and partially type-tested assemblies (IEC 60439-1); German version EN 60439-1
EN 60529	Degrees of protection provided by enclosures (IP Code) (IEC 60529)
EN 60664-1	Insulation coordination for equipment within low-voltage systems Part 1: Principles, requirements and tests (IEC 60664-1)
EN 60721-3-1	Classification of environmental conditions - Part 3-1: Classification of groups of environmental parameters and their severities - Section 1: Storage (IEC 104/648/CD)
EN 60721-3-2	Classification of environmental conditions - Part 3: Classification of groups of environmental parameters and their severities - Section 2: Transportation and handling (IEC 104/670/CD)
EN 60721-3-3	Classification of environmental conditions - Part 3: Classification of groups of environmental parameters and their severities; section 3: Stationary use at weatherprotected locations; Amendment A2 (IEC 60721-3-3); German version EN 60721-3-3
EN 61000-2-1	Electromagnetic compatibility (EMC) - Part 2: Environment - Section 1: Description of the environment - Electromagnetic environment for low-frequency conducted disturbances and signalling in public power supply systems
EN 61000-2-4	Electromagnetic compatibility (EMC) - Part 2-4: Environment; Compatibility levels in industrial plants for low-frequency conducted disturbances (IEC 61000-2-4); German version EN 61000-2-4
EN 61000-4-2	Electromagnetic compatibility (EMC) - Part 4-2: Testing and measurement techniques - Electrostatic discharge immunity test (IEC 61000-4-2); German version EN 61000-4-2
EN 61000-4-3	Electromagnetic compatibility (EMC) - Part 4-3: Testing and measurement techniques - Radiated, radio-frequency, electromagnetic field immunity test (IEC 61000-4-3); German version EN 61000-4-3
EN 61000-4-4	Electromagnetic compatibility (EMC) - Part 4-4: Testing and measurement techniques - Electrical fast transient/burst immunity test (IEC 61000-4-4); German version EN 61000-4-4
EN 61000-4-5	Electromagnetic compatibility (EMC) - Part 4-5: Testing and measurement

EN61000-4-6	techniques - Surge immunity test (IEC 61000-4-5); German version EN 61000-4-5 Electromagnetic compatibility (EMC) - Part 4-6: Testing and measurement techniques - Immunity to conducted disturbances, induced by radio-frequency fields (IEC 61000-4-6); German version EN 61000-4-6
EN61000-4-34	Electromagnetic compatibility (EMC) - Part 4-34: Testing and measurement techniques - Voltage dips, short interruptions and voltage variations immunity tests for equipment with mains current more than 16 A per phase (IEC 61000-4-34); German version EN 61000-4-34
EN 61131-2	Programmable controllers - Part 2: Equipment requirements and tests (IEC 61131-2)
EN61373	Railway applications - Rolling stock equipment - Shock and vibration tests (IEC 61373)
EN61439-1	Low-voltage switchgear and controlgear assemblies - Part 1: General rules (IEC 121B/40/CDV); German version FprEN 61439-1
EN61508-1...7	Functional safety of electrical/electronic/programmable electronic safety-related systems – Part 1...7 (VDE 0803-1...7, IEC 61508-1...7)
EN61800-2	Adjustable speed electrical power drive systems - Part 2: General requirements - Rating specifications for low voltage adjustable frequency a.c. power drive systems (VDE 0160-102, IEC 61800-2)
EN61800-3	Speed-adjustable electrical drives. Part 3: EMC requirements and specific test methods (VDE 0160-103, IEC 61800-3)
EN61800-5-1	Adjustable speed electrical power drive systems - Part 5-1: Safety requirements - Electrical, thermal and energy (IEC 61800-5-1); German version EN 61800-5-1
EN61800-5-2	Adjustable speed electrical power drive systems - Part 5-2: Safety Requirements - Functional (IEC 22G/264/CD)
EN62061	Safety of machinery - functional safety of electrical, electronic and programmable electronic safety-related systems (VDE 0113-50, IEC 62061)
EN ISO 13849-1	Safety of machinery - safety-related parts of control systems - Part 1: General principles for design (ISO 13849-1); German version EN ISO 13849-1
UL61800-5-1	American version of the EN 61800-5-1 with „National Deviations“

1 Basic Safety Instructions

The COMBICONTROL is designed and constructed in accordance with state-of-the-art technology and the recognised safety rules and regulations. However, the use of such devices may cause functional hazards for life and limb of the user or third parties, or damages to the system and other material property.

The following safety instructions have been created by the manufacturer for the area of electric drive technology. They can be supplemented by local, country- or application-specific safety instructions. This list is not exhaustive. Non-observance of the safety instructions by the customer, user or other third party leads to the loss of all resulting claims against the manufacturer.

NOTICE



Hazards and risks through ignorance.

- ▶ Read the instructions for use !
- ▶ Observe the safety and warning instructions !
- ▶ If anything is unclear, please contact KEB Automation KG !

1.1 Target Group

This manual is written for design, project planning, servicing and commissioning experts. Qualified personnel for the purpose of this instruction manual must have the following qualifications:

- Knowledge and understanding of the safety instructions.
- Knowledge of automation technology.
- Knowledge of functional safety.
- Skills for installation and assembly of electrical equipment.
- Detection of hazards and risks of the electrical drive technology.
- Understanding of the function in the used machine.
- Knowledge of the operation of the Windows operating system.
- Knowledge of *DIN IEC 60364-5-54*.
- Knowledge of *EN 60204-1*
- Knowledge of national safety regulations (e.g. *DGUV regulation 3*).

1.2 Transport, storage and proper use

The transport is carried out by qualified persons in accordance with the environmental conditions specified in this manual. The devices shall be protected against excessive strains.



Electronic devices contain electrostatic sensitive components.

- ▶ Avoid contact.
 - ▶ Wear ESD-protective clothing.
-

Do not store the devices

- in the environment of aggressive and/or conductive liquids or gases.
- with direct sunlight.
- outside the specified environmental conditions.

1.3 Installation

⚠ DANGER



Do not operate in an explosive environment!

- ▶ The device is not intended for the use in potentially explosive environment.
-

To prevent damages to the device:

- Make sure that no components are bent and/or isolation distances are changed.
- The device must not be put into operation in case of mechanical defects. Non-compliance with the applicable standards.
- Do not allow moisture or mist to penetrate the unit.
- Avoid dust permeating the device. Allow for sufficient heat dissipation if installed in a dust-proof housing.
- Note installation position and minimum distances to surrounding elements. Do not cover the ventilation openings.
- Mounting according to the specified degree of protection.
- Make sure that no small parts fall into the device during assembly and wiring (drilling chips, screws etc.). This also applies to mechanical components, which can lose small parts during operation.
- Check the reliable fit of the device connections in order to avoid contact resistances and sparking.
- The safety instructions are to be kept!

1.4 Electrical connection

ATTENTION

In order to prevent malfunctions or unpredictable conditions, observe the following instructions:

- ▶ For any work on the device switch off the supply voltage.
- ▶ Never bridge upstream protective devices (also not for test purposes).
- ▶ Install all required covers and protective devices for operation.
- ▶ The electrical installation shall be carried out in accordance with the relevant requirements.
- ▶ Cable cross-sections and fuses must be dimensioned according to the design of the machine manufacturer. Specified minimum / maximum values may not be fallen below /exceeded.
- ▶ With existing or newly wired circuits the person installing the units or machines must ensure the EN requirements are met.
- ▶ When using components without isolated inputs/outputs, it is necessary that equipotential bonding exists between the components to be connected (e.g. by the equipotential line). Disregard can cause destruction of the components by equalizing currents.

1.5 Start-up and operation

When the device is installed in machines, start-up (i.e. commencement of the intended operation) is prohibited until it is determined that the machine complies with the machine directive; Account is to be taken of [EN 60204-1](#).

- During operation, all covers and doors shall be kept closed.
- Use only approved accessories for this device.
- Never touch terminals, busbars or cable ends.

1.6 Maintenance

The following maintenance work has to be carried out when required, but at least once per year by authorized and trained personnel. Check unit for loose screws and plugs and tighten if necessary.

- ▶ Check unit for loose screws and plugs and tighten if necessary.
- ▶ Clean the device from dirt and dust deposits. Depending on the device, pay particular attention to ventilation slots or cooling fins.
- ▶ Examine and clean extracted air filter and cooling air filter of the control cabinet.

1.8 Repair

In case of malfunction, unusual noises or smells inform a person in charge!

DANGER



Unauthorized exchange, repair and modifications!

Unpredictable malfunctions!

- ▶ The function of electronic devices can be influenced by the setting and parameterization. Never replace without knowledge of the application.
- ▶ Modification or repair is permitted only by KEB Automation KG authorized personnel.
- ▶ Only use original manufacturer parts.
- ▶ Infringement will annul the liability for resulting consequences.

1.7 Disposal

Electronic devices of the KEB Automation KG are exclusively professional devices for further industrial processing (so-called B2B devices).

Manufacturers of B2B devices are obliged to take back and recycle devices manufactured after 14.08.2018. These devices may not be disposed at the collection centres of public sector disposal organisations.

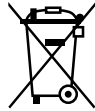

If no deviating agreement has been made between the customer and KEB or no deviating mandatory legal regulation exists, KEB products marked in this way can be returned. Company and keyword to the return point can be taken from the list below. Shipping costs are paid by the customer. Thereupon the devices will be professionally recycled and disposed.

The entry numbers are listed country-specific in the following table. The corresponding KEB return addresses can be found on our website.

Withdrawal by	WEEE-Reg.-No.	Keyword
Austria		
KEB Automation GmbH	ERA: 51976	Stichwort „Rücknahme WEEE“
France		
RÉCYLUM - Recycle point	ADEME: FR021806	Mots clés „KEB DEEE“
Germany		
KEB Automation KG	EAR: DE12653519	Stichwort „Rücknahme WEEE“
Italy		
COBAT	AEE: (IT) 19030000011216	Parola chiave „Ritiro RAEE“

The packaging must be feed to paper and cardboard recycling.

2 System Description

C6 P34 BM is a fanless wall Book Mount IPC designed for installation in industrial control cabinets based on Celeron, Core™ i3, i5 and i7 dual and quad core 64 bit processors of the Intel® Skylake™ platform.

C6 P34 BM systems are supplied with a sturdy Aluminium chassis, highly refined in every aesthetic and ergonomic detail. The “all in one” motherboard provides, on top, four Ethernet 10/100/1000Mbps ports, that support “Jumbo Frame” and “Wake on Lan” functionalities, two USB 2.0 ports, two USB 3.0 ports, one DVI-D video output and, as an option, one or two Remote Video Link connectors (RJ45); on front, a USB 3.0 port, a SATA III CFAST slot, a slot for the extractable system battery, the signaling LEDs and optionally two slots for extractable storage units drawers.

The motherboard has also an mSATA connector for a SATA III SSD, two SATA III connector for 2,5” SSD the possibility to set the mass storage devices in RAID 0, 1 configuration, up to 32 GB RAM with two DDR4 SODIMM modules and an internal connector for additional serial or USB interfaces.

C6 P34 BM systems are provided with 24 VDC power supply input and an integrated UPS.

2.1 Concepts

- „on top“ interfaces
 - Ergonomic cabling
 - Reduced installation space
 - Protection against accidentally cable disconnection
- „on front“ interfaces
 - Better visibility of signals/warnings
 - Better access to removable devices like extractable drawers for SSD.
- Chassis & expandability
 - Full aluminium
 - Compact, solid and robust
 - Expandability ensured by two PCI slots
- Themic dissipation
 - Fanless operation
 - 0÷50°C operating temperature

2.2 Highlights

- Fanless book mounting PC (0÷50°C operating temperature)
- KEB COMBIVIS CONNECT runtime included
- Intel® Skylake platform
Intel® Core™ i5-6440EQ 2,7Ghz (3,4GHz Turbo), 4 cores – 4 threads – 6MB smart cache
- System RAM memory expandable up to 32GB
- 4 or 1 x PCI x 4 slot
- Mass storage 1 x CFast, 1 x mSATA SSD and 2 x 2,5" SSD with SATA III interface also with extractable drawers and RAID 0, 1 configurations
- Integrated Remote Video Link video output for remotation of DVI-D and USB 2.0 signals up to 100 m (optional)
- Isolated 24V DC power supply input and Micro UPS

2.2.1 Isolated Power Supply

Isolated Power supply with galvanic isolation to prevent:

- Common mode noise at low/medium frequencies on the power supply line
- Ground loop noise
- Extra-voltage caused by lightning
- Power supply with grounded positive terminal (e.g. Japan)

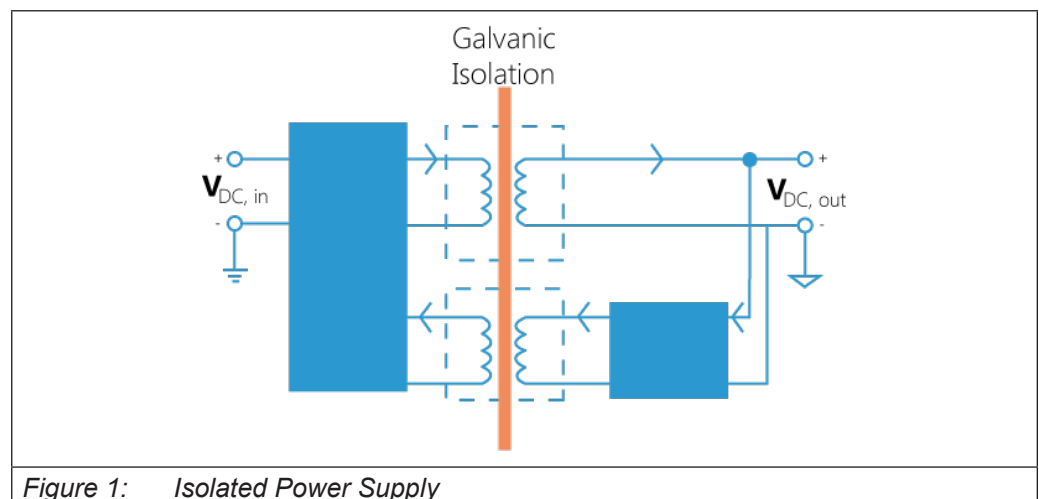





Figure 1: Isolated Power Supply

2.3 Package

Package consists of:

C6 P34 BM	
n.1 Power supply plug (pre-installed on the system)	
n.1 Power supply cover	
n.1 DVI-I / VGA adapter (option)	
<p>Figure 2: Package</p>	

2.4 Front

C6 P34 BM front panel is available with 1 or 2 doors.

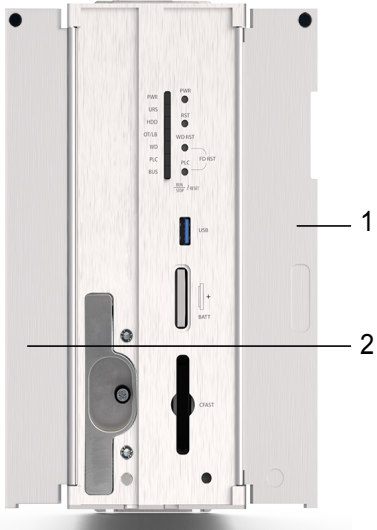
	
1	Right door
2	Left door
<p>Figure 3: Front detail</p>	

2.5 Rear

The back of the system is made of a full aluminium plate.

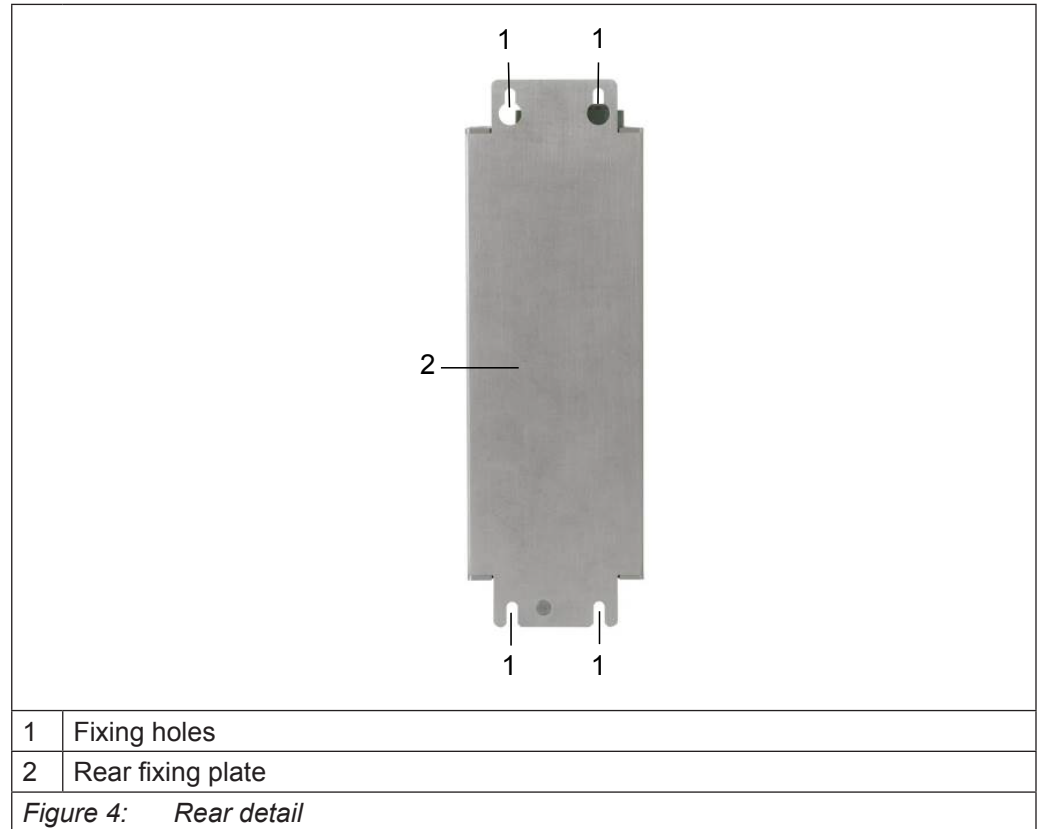

2.6 D0, D1 version

The system is available with no extractable disk (D0) or with n1 extractable disk (D1).

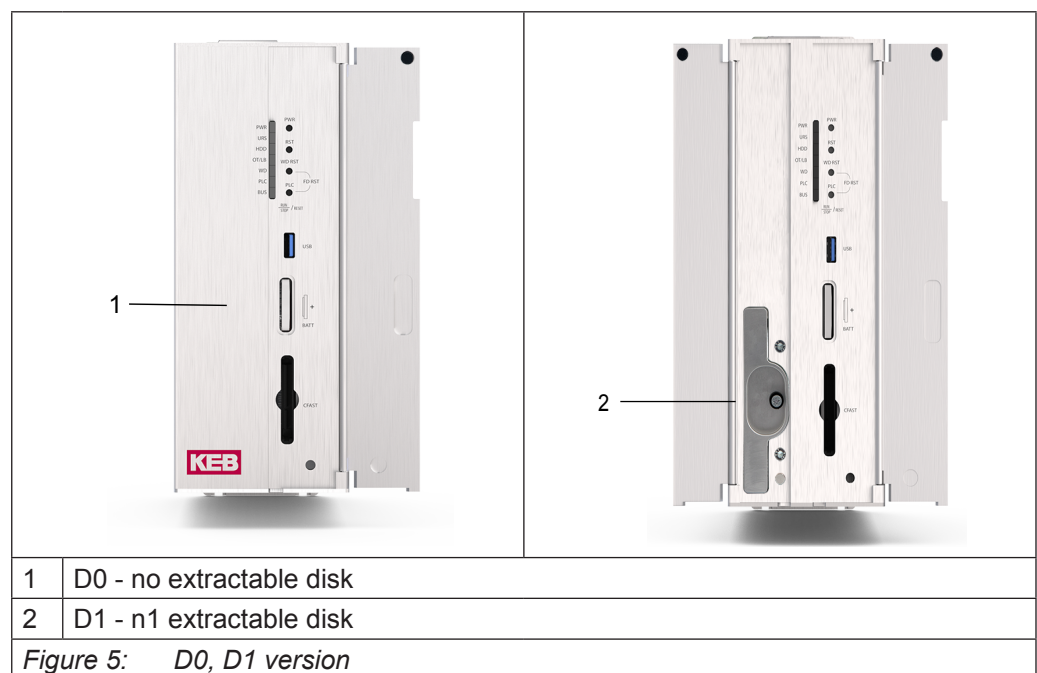

2.6.1 Connectors

To access the connectors, it is necessary to open the frontal flap.

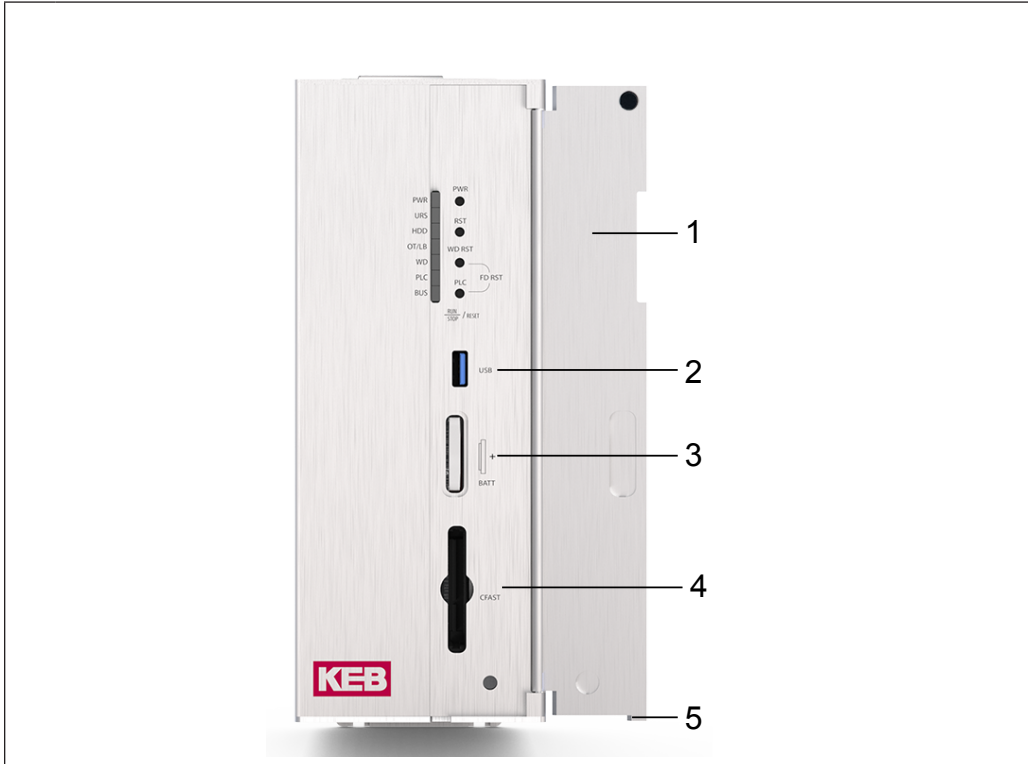

1	Front door
2	USB 3.0 connector
3	Battery slot
4	CFAST slot sata2
5	Opening handle
<i>Figure 6: Connector detail</i>	

2.6.2 C6 P34 BM S0 - Top Connectors / LED

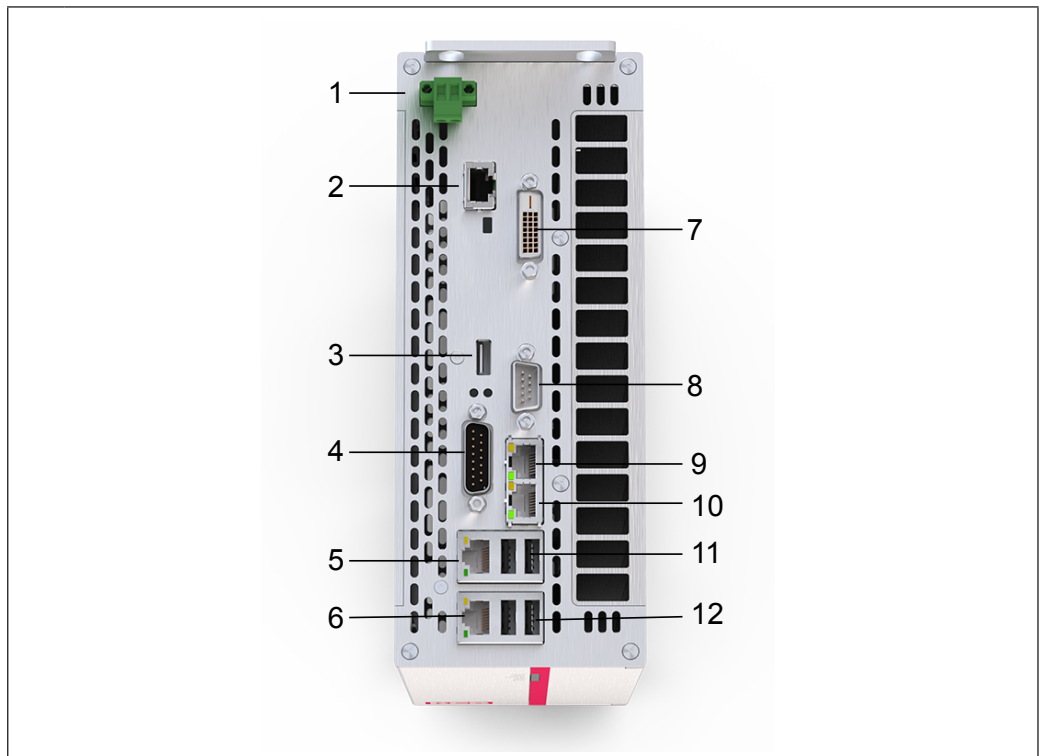

1	Power DC input connector
2	RVL - optional
3	USB 5 - optional
4	COM 3 - optional
5	LAN 1 / Bus
6	LAN 2
7	DVI
8	COM 1
9	LAN 4
10	LAN 3
11	USB 3-4
12	USB 1-2

Figure 7: Top connectors detail

2.6.3 LED Signaling



1	LED signaling area
---	--------------------

Figure 8: LED signaling detail

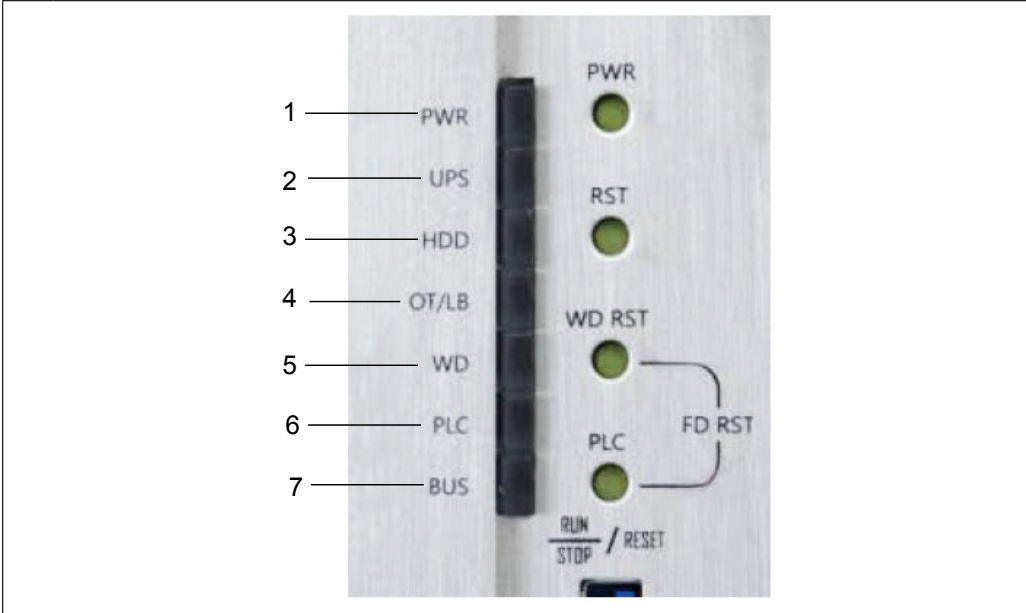

1	Power on LED
2	UPS LED
3	HDD activity LED
4	Over temperature / Battery fault LED
5	Watchdog / Reset factory default LED
6	PLC status LED
7	Bus status LED

Figure 9: Buttons area detail

2.6.4 Buttons Area



1	Buttons area
---	--------------

Figure 10: Buttons area detail

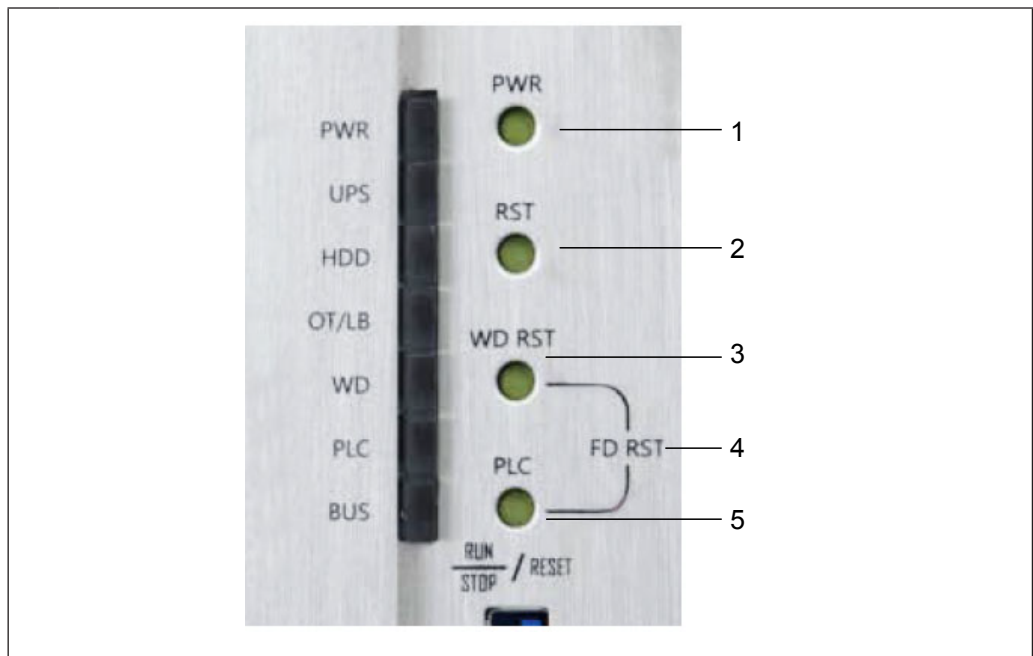

1	Power on rest
---	---------------

2	System reset
---	--------------

3	Watchdog reset
---	----------------

4	Factory default reset
---	-----------------------

5	PLC Run/Stop/Reset
---	--------------------

Figure 11: Buttons area detail

2.6.5 Power Supply / Screw for functional equipotential bonding

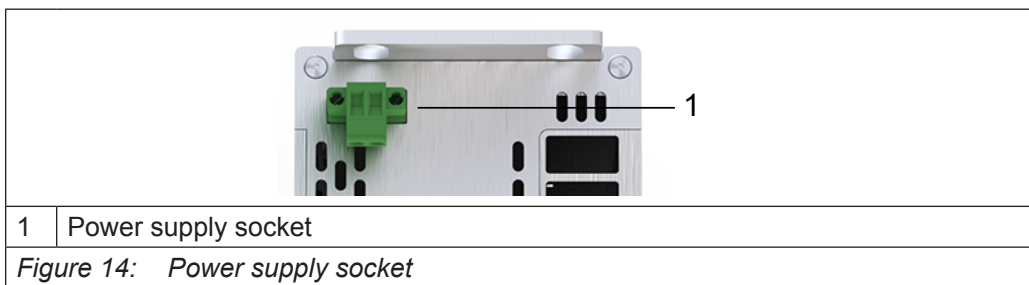
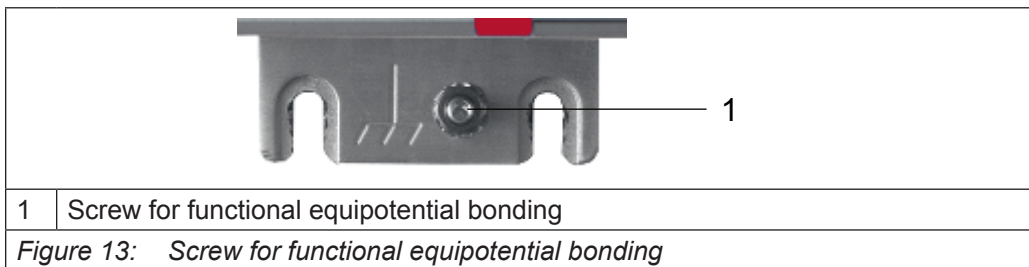
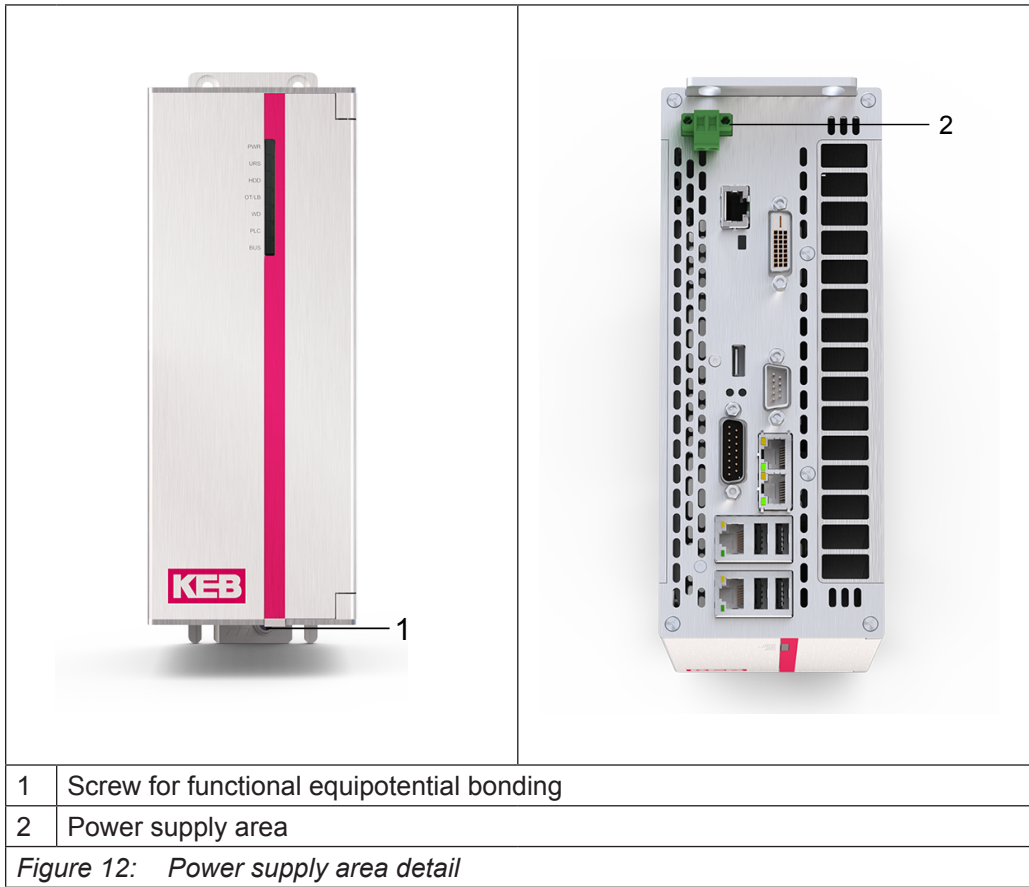

2.6.6 Battery CR2032 3V

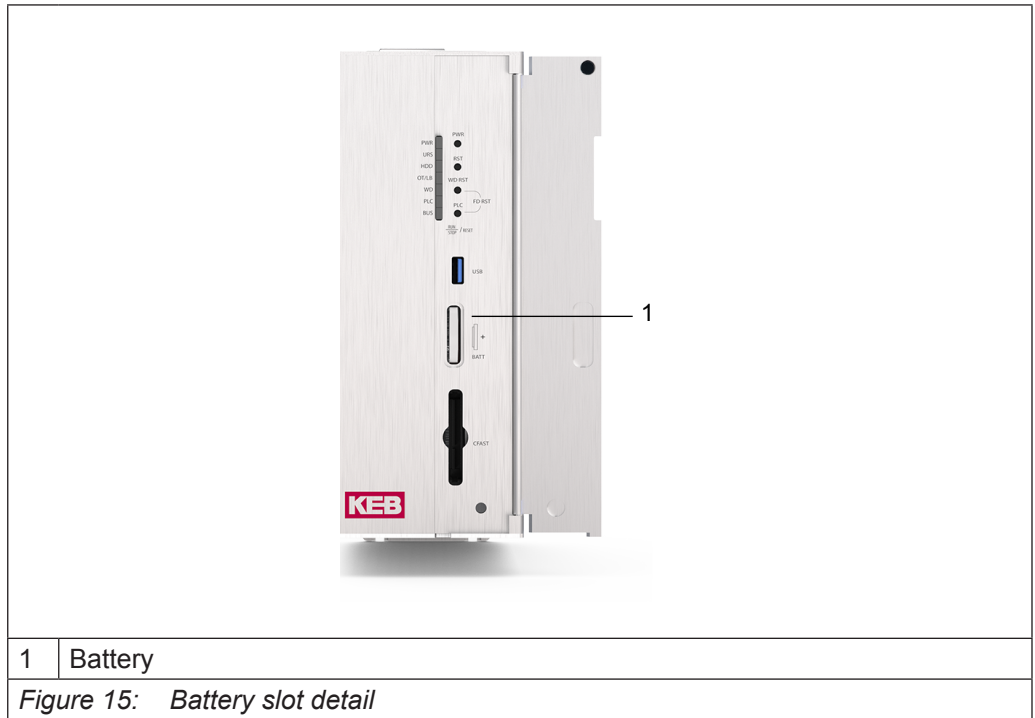
**⚠ DANGER****Risk of explosion!****If the battery is replaced with an incorrect type.****Dispose of used batteries according to the instructions.**

2.6.7 CFast



1 CFast

Figure 16: CFast slot detail

⚠ WARNING

Only use KEB approved CFast cards for industrial application. All the CFast cards intended for other uses (digital cameras, consumer products) do not have the endurance, the performance and the security features (as data reliability in case of a sudden power-off) required for an industrial application.

⚠ WARNING

Removing the system memory card while the project is running. If you remove memory card while a project is running, the project may stop.

⚠ WARNING

Potential data loss
Do not remove the memory card while data is being accessed. Data on the memory card is lost if you at-tempt to remove it while the system is ac-cessing its data.

2.6.8 Mass storage

CFast	1 x bootable CFast SATA II embedded on board with external access
Internal SSD mSATA	(alternative to 2,5"), 1 x mSATA SATA III internal connector for direct in
Internal 2.5" HDD	(alternative to mSATA), 1 x SATA III connector for HDD 2,5" with installation kit (also 24x7)
Internal 2.5 SSD	(alternative to mSATA), 1 x SATA III connector for SSD 2,5" with installation kit

Figure 17: Mass storage

2.6.9 Add-on interface (optional)

The system can optionally and alternately integrate the following interface:
 1 x RS232/422/485 (DB15M) isolated ▪ 1 x USB 2.0

2.6.10 Labels position

On the lateral panel the following label is present:

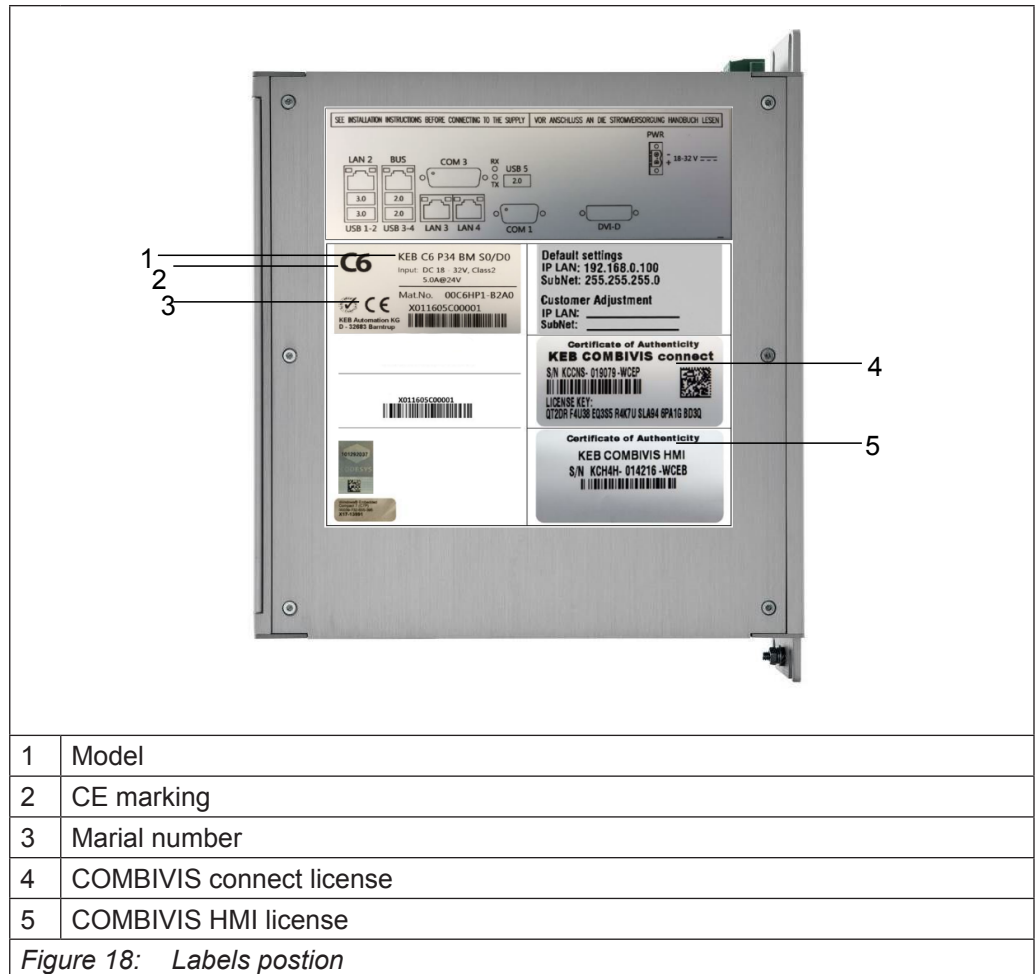

3 Installation and connection

3.1 Preparation for installation

3.1.1 Select the mounting location

- Avoid direct sunlight exposure.
- Make sure that C6 P34 BM is properly (ergonomically) accessible to the operator.
- Choose a suitable mounting height.

3.2 Checking the package contents

- Check the package content for visible signs of transport damage and for completeness.
- In the case of damaged parts, contact your KEB representative. Do not install parts that were damaged during the shipment.

3.3 Checking the operating conditions

- Read carefully the standards, approvals, EMC parameters and technical specifications for operation of the device. This information is available in the following sections:
 - a) Certificates and approvals.
 - b) Electromagnetic compatibility .
- Check the mechanical and climatic ambient conditions for operation of the device.
- Follow the instructions for local use of the device.
- Adhere to the permissible rated voltage and the associated tolerance range.

3.4 Mounting position

C6 P34 BM device is suitable for wall book mounting installation.

3.5 Damage due to overheating

- All C6 P34 BM systems are designed for vertical position mounting.
- The ambient temperature must be between 0°C to +50°C measured 5 cm from all openings of the system where there is air entrance.
- Provide space around the system for air recirculation and heat ex-change.
- Mounting angle:
 - a) The system is intended to be mounted vertically.
 - b) For other installation modes contact KEB.



For installation in control cabinets and, in particular, in closed containers, make sure the recommended ambient temperature is maintained.

3.6 Dimensions

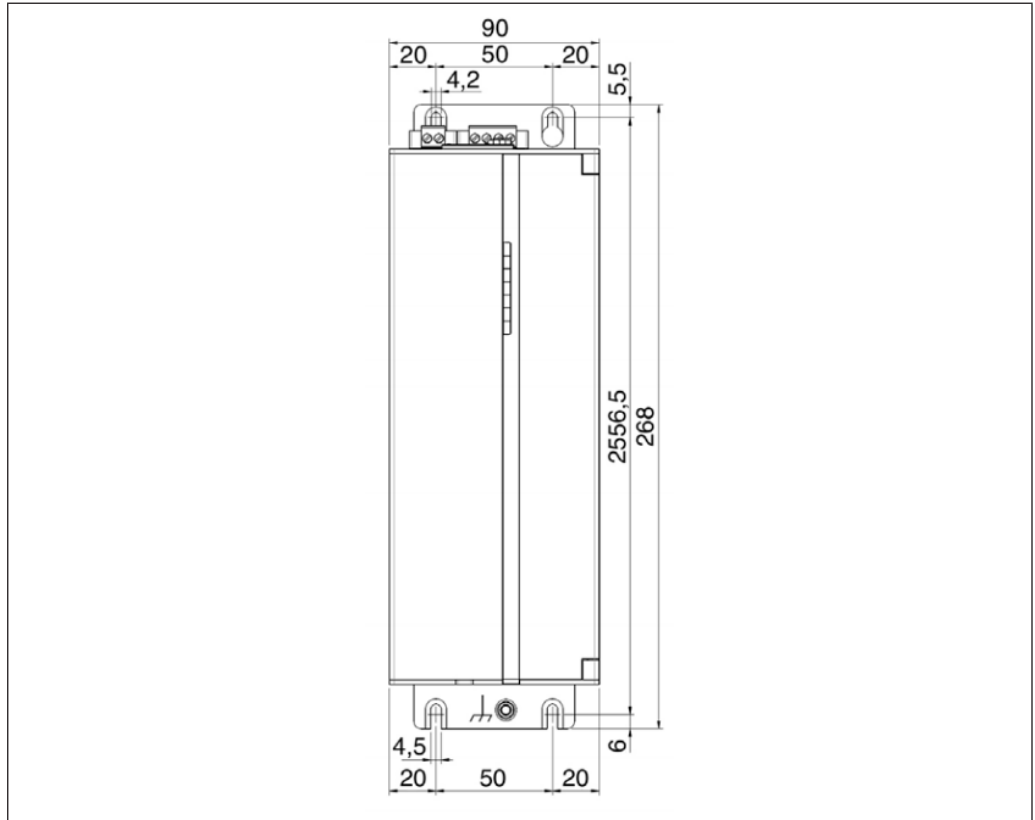

Figure 19: C6 P34 - dimensions

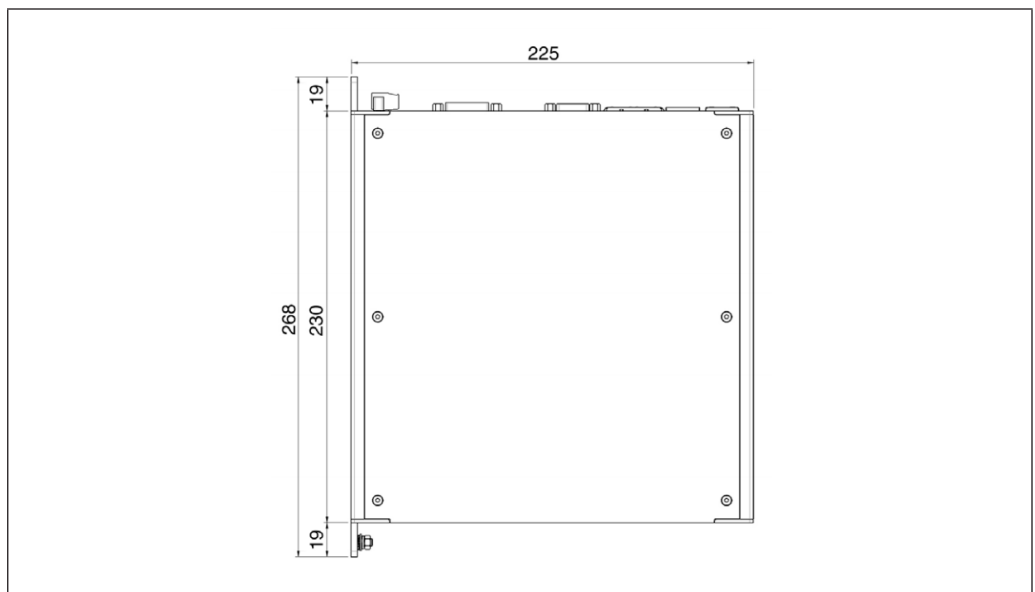



Figure 20: C6 P34 BM - dimensions

3.7 Mounting the device

The system can be installed on a panel/wall as follows:

Tool required	Action
	
Cross screwdriver 2.5 mm	Screw / unscrew n.4 fixing screws

- Drill the required holes on the housing panel/wall according to the instructions detailed in paragraph dimensions.
- There are 4 fastening points. Fastening can be made using stainless steel screws M4x20.



Figure 21: Wall mounting procedure

- Hang system as shown in the picture.
- First lift and insert the top.
- Align the bottom.



Figure 22: Wall mounting procedure

- Release the top to match the slots with the screws.



Figure 23: Wall mounting procedure

- Tighten the four screws.



Figure 24: Wall mounting procedure

3.8 Equipotential Grounding and bonding

Whenever two pieces of equipment connected to each other are far apart, it is possible that their ground connections could be at a different potential level. The data cable screens connecting the equipment's chassis on one end and the C6 P34 BM chassis on the other end can therefore be subject to a high current circulation capable of destroying the interface. To overcome this hazard such current must be steered away from the interface. To achieve this goal the following methods can be used:

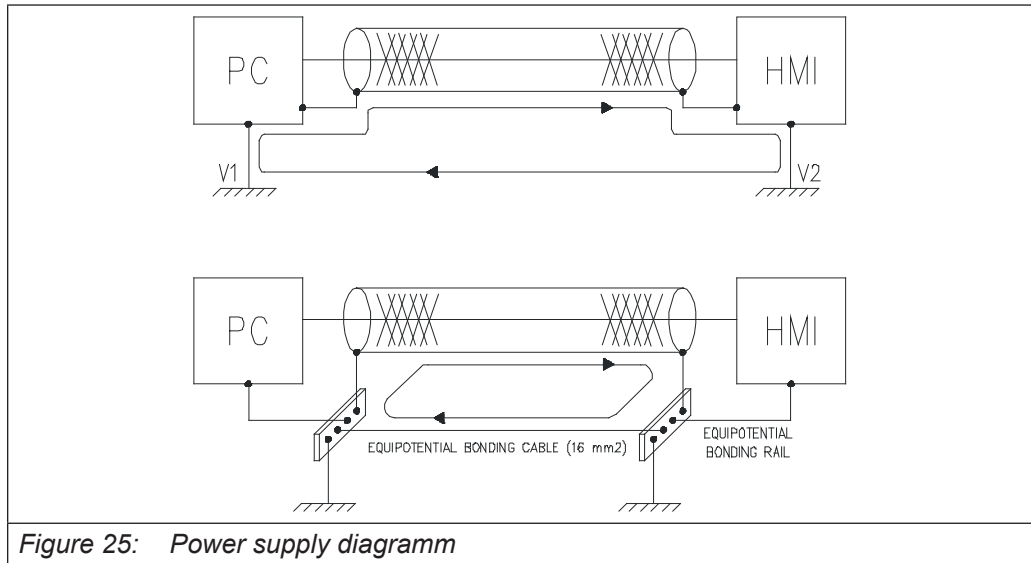

Figure 25: Power supply diagramm

1. Use an equipotential bonding cable (16mm²) to connect the equipment ground to the C6 E22 BM ground.
2. Connect the data cable screens to the equipotential bonding rail on both sides before connecting the cable to the interfaces.

Insert the equipotential bonding eyelet terminal between the washers in the following sequence:

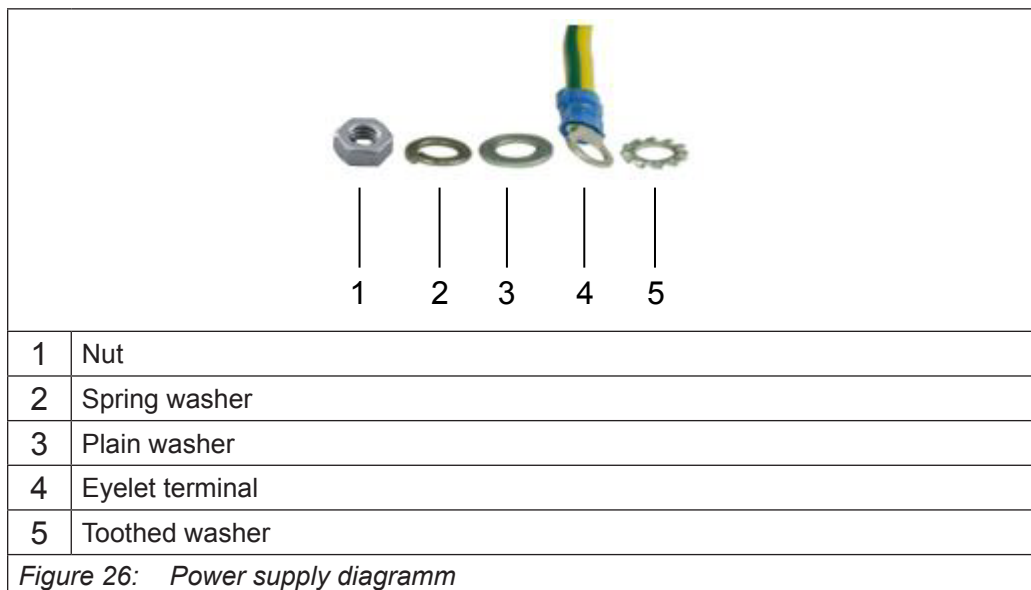

Figure 26: Power supply diagramm



Figure 27: Grounding detail

- Tighten the four screws.

3.8.1 Power supply insulation

The C& P34 BM power supply is galvanically isolated which means the outputs are electrically insulated from the inputs. This feature has many benefits:

- Increases the noise immunity of the system.
- Avoids input short circuits in systems with the power supply grounded.
- Breaks ground loops which may cause interferences in the video signals.

3.8.2 Wiring diagram

The wiring diagram shows a simplified pictorial representation of the electrical circuit. It shows the components of the circuit as simplified shapes, and the power and signal connections between the devices.

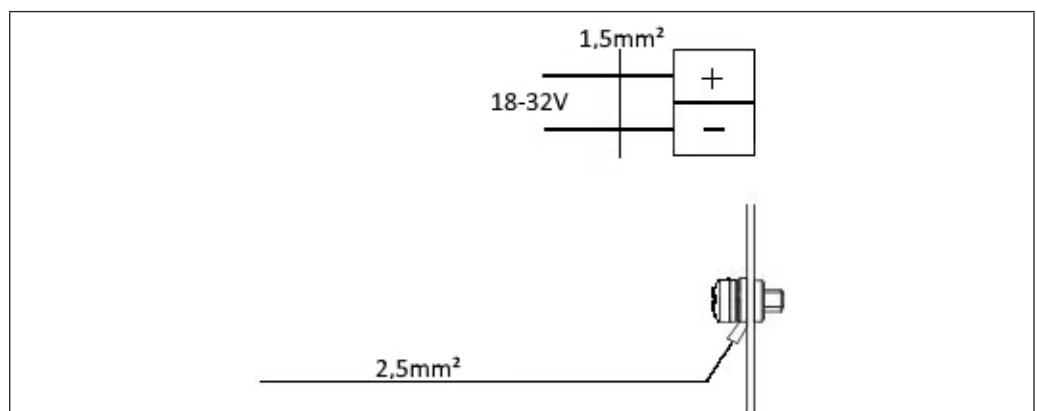

Figure 28: Power supply connection detail

- Connect the positive and the negative poles (also refer to the label on the back of the system) to their respective terminals of the two pole plug connector. Use wires with a cross-section of 1.5 mm² (AWG16).

3.8.3 Power connection assembly

The system is equipped with a connector cup to be installed on the two poles power connector. To properly assemble the connector please follow these instructions:



Figure 29: Power connector assembly

- Insert the cable tie in the cup as shown in the picture.



Figure 30: Power connector assembly

- Slide the cable tie as shown in the picture.

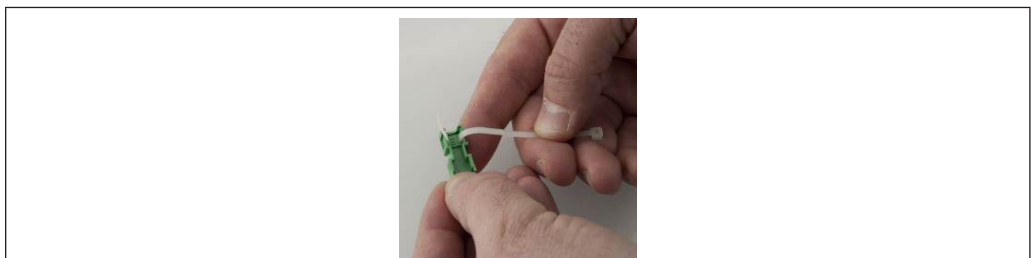

Figure 31: Power connector assembly

- Place the two poles plug connector in the cup as shown in the picture.

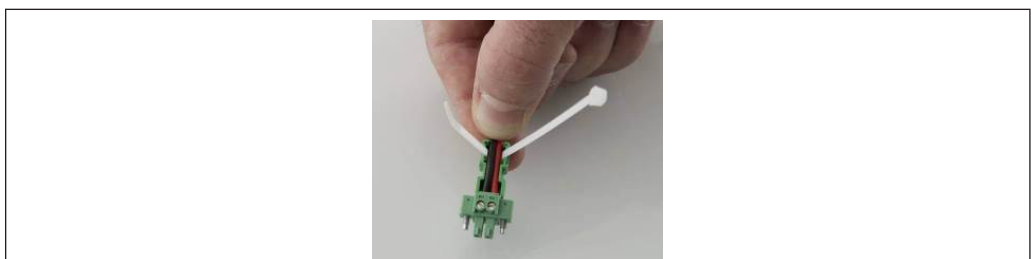

Figure 32: Power connector assembly

- Tighten the cable tie.

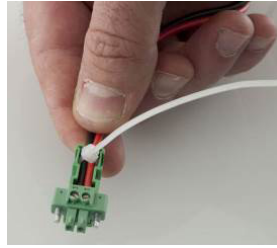

Figure 33: Cup installation

- Cut the excess part.

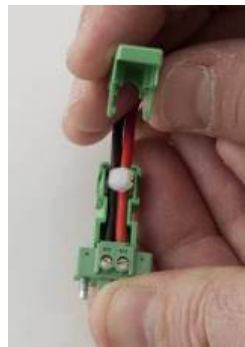

Figure 34: Cup installation

- Insert the white label and close the cup as shown in the picture.



Figure 35: Cup installation

- Example of a correctly installed cup.

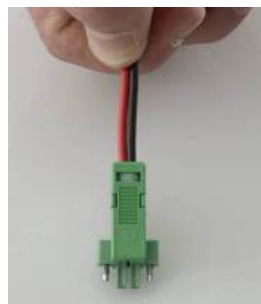

Figure 36: Power connector assembly

3.8.4 Power on

The system has to be connected to a 24 V (18-32V) power supply which satisfies the requirements of safe extra low voltage (SELV) in accordance with IEC/EN/DIN EN/UL60950-1.

- Remove the two poles plug connector from the system (the system is shipped with the power plug connected).
- Always check that the voltage drop along the supply wiring is not excessive and the input voltage remains above the minimum required (18V) in the worst load condition.
- Connect the ground cables (PE) to the equipotential bonding points.



Figure 37: Connecting the ground cables



Figure 38: Power on sequence

- The system begins bootstrap.

3.9 Shutdown

To shut down the system please follow the standard procedure of your operating system. After power down procedure is completed, the system will be put in a soft-off state, front side led will become yellow, and the user will be allowed to switch off power supply to the system. In this state the system will dissipate negligible power.

4 Operating Systems

4.1 KEB Windows Images (Windows Embedded Standard 7 / Windows 10)

4.1.1 Introduction

KEB has created a "Windows Embedded Standard 7" (WES7) / Windows 10 (Win10) image for C6 E22 / C6 P3x with special features that support the work with the devices.

4.1.2 User Accounts

There are two user accounts implemented in the KEB image: AutoLogon and remote. The following table shows the details for the accounts:

Account	AutoLogon	remote
Administrator	Yes	Yes
Password	No	remote
Remote access	Not possible	Yes
Intention	Automatic logon after reboot	Remote Desktop connection

Table 1: User Accounts

WARNING

The default password for "remote" account should be changed to an individual password for security reasons.

The AutoLogon should be continuously used as the standard logon, because only a logon without password reaches immediate start of Control and HMI application after boot of the device, which is generally the desired behavior for a machine control device. Since in WES7 / Win10 a remote logon as account without password is not possible, there is no security risk regarding the missing password for AutoLogon.

Of course own user accounts can be created, but this is not the default approach destined by KEB.

4.1.3 Ethernet Address

The C6 E22 / C6 P3x are configured to obtain an IP address from a DHCP server. If no DHCP server is available in the network the device uses the IP address 192.168.0.100. Thus it is also possible to connect directly to the device without a network infrastructure with a development PC by configuring the Ethernet adapter of the development PC with another 192.168.0.xxx address.



Switching to the IP address 192.168.0.100 by the device can take several minutes because the device waits this time for the possible DHCP address assignment.

4.1.4 Usage of storage memories

The C6 E22 C6 P3x is delivered with two hard disk drives, a SSD and a CFast card. In Win7 Image the SSD is divided into two volumes C:\ and D:\ of its half size each. On C:\ the Operating System and the runtimes (Control, HMI, Connect) are located. D:\ is reserved for future use.

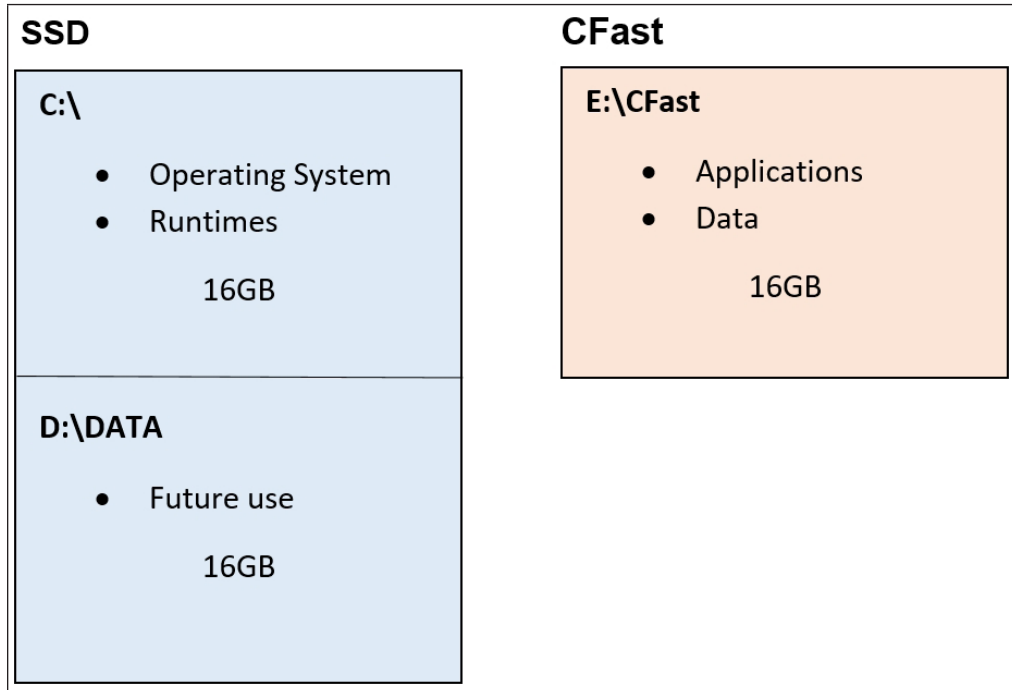

The SSD is not divided in Win10.

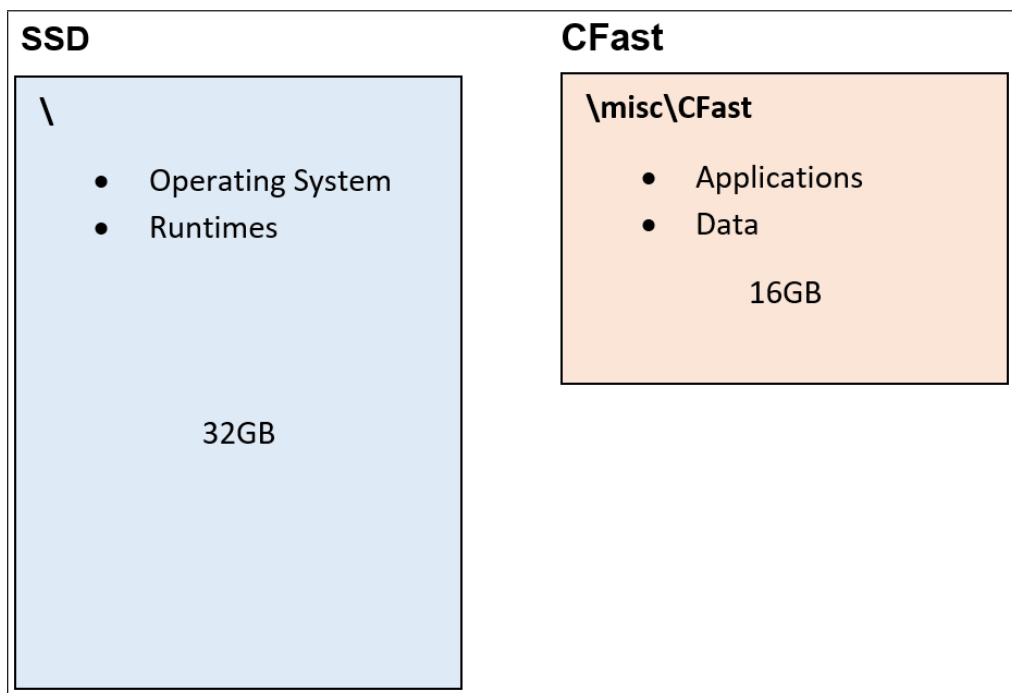

The applications and data are separated and located on the CFast (E:\). Since the CFast is easy to remove, the applications can easily be transmitted to an exchange device.

4.1.5 Firewall

The Windows-firewall is enabled in the delivery state. This protects the device against many types of network based attacks. KEB has configured the Windows firewall that all foreseen network connections are allowed. The Control runtime and the HMI runtime are allowed to open all network ports because for both programs a rule in the firewall exists.



This is the recommended way to configure a firewall: allow (trusted) programs to open any port instead of allow ports to be opened by any program.

However, in case of assumption that the firewall blocks desired network communication there is an easy way to disable the firewall completely for testing. On the desktop you find a "FirewallDisable" shortcut which does this and also a shortcut for enabling the firewall again.

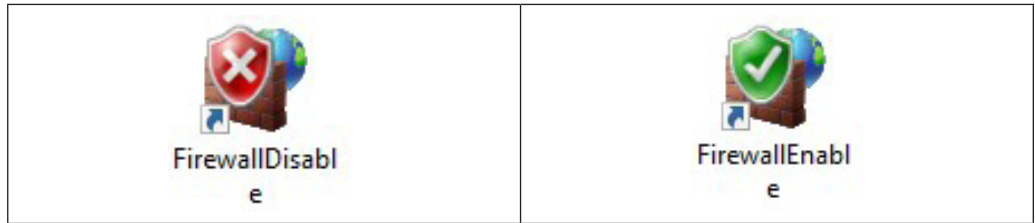

The commands need "elevated rights". Confirm the question from the User Account Control with "Yes":

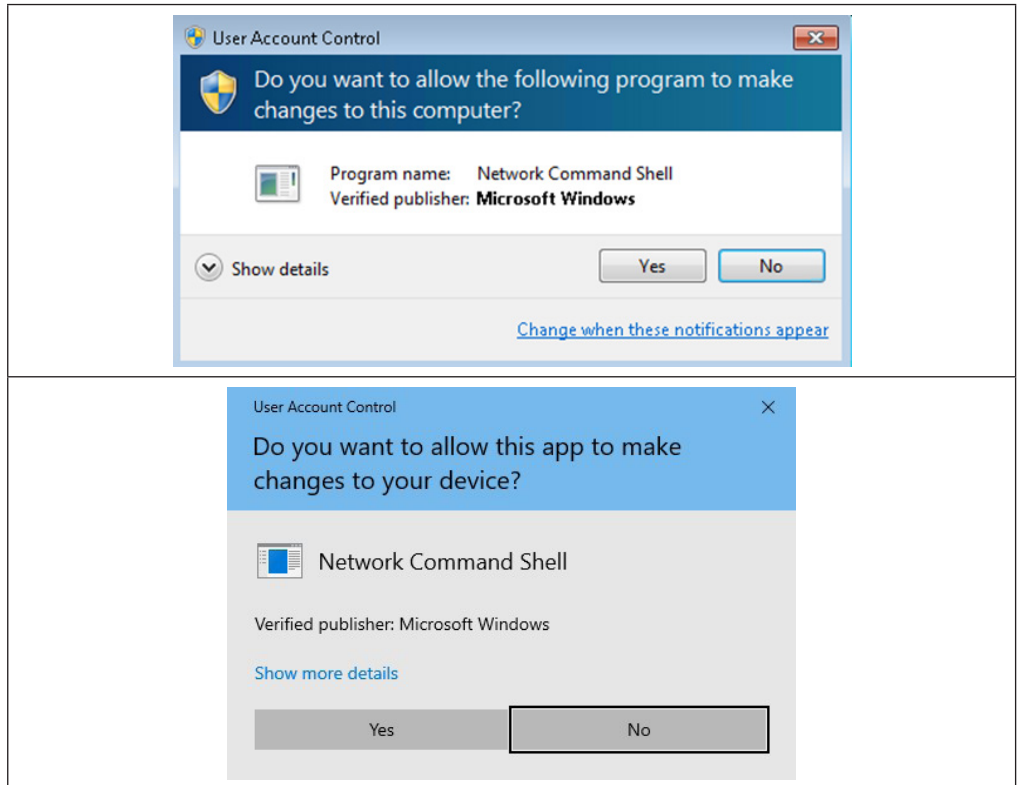



It is not recommend to disable the firewall permanently. If the test with disabled firewall confirms that the desired network commu-
 nication is possible, an appropriate rule should be implemented
 in the firewall configuration (preferred for a program instead of a
 port) and the firewall should be activated again. How to implement
 firewall rules can be referred on the appropriate web sites from Mi-
 crosoft for Windows 7 / Windows 10.

4.1.6 eGalax Touch Driver

The eGalax driver is installed on all C6 E22 / P3x devices, except the panel devices with capacitive touch. This driver supports all touch controllers of C6 E22 / P3x panel devices and external C6 monitors from KEB. But it does not support Multi-Touch functionality. Multi-Touch functionality is only possible with capacitive panel devices and requires the WES7/Win10 internal Microsoft Touch driver.

This driver, in turn, is not able to operate resistive touch displays. The following table gives an overview:

	Resistive	Capacitive
Single Touch	eGalax driver	eGalax driver
Multi Touch	Not possible	Microsoft touch driver

The appropriate driver is installed on C6 E22 / C6 P3x panel devices. For Box and Bookmount devices, this preselection could not be done at the factory because the used external C6 monitor is not known at the time of production. Thus the eGalax driver is installed on those devices. If they are used in combination with capacitive C6 monitors (and Multi Touch functionality is desired at all) it is necessary to uninstall the eGalax driver. The Microsoft touch driver becomes active than automatically after 2 reboots. To uninstall the eGalax driver you find an “eGalaxUninstall” desktop shortcut which does this and also a shortcut for installing the eGalax again.

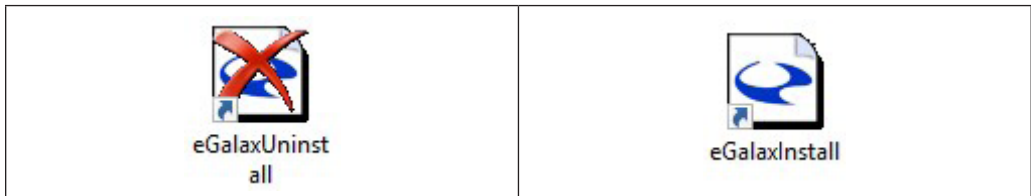

Since the used touch technology is predetermined for C6 E22 / C6 P3x panel devices, the desktop shortcuts are not placed on the desktop on these devices.

The commands need “elevated rights”, thus please confirm the question from the User Account Control with “Yes”:

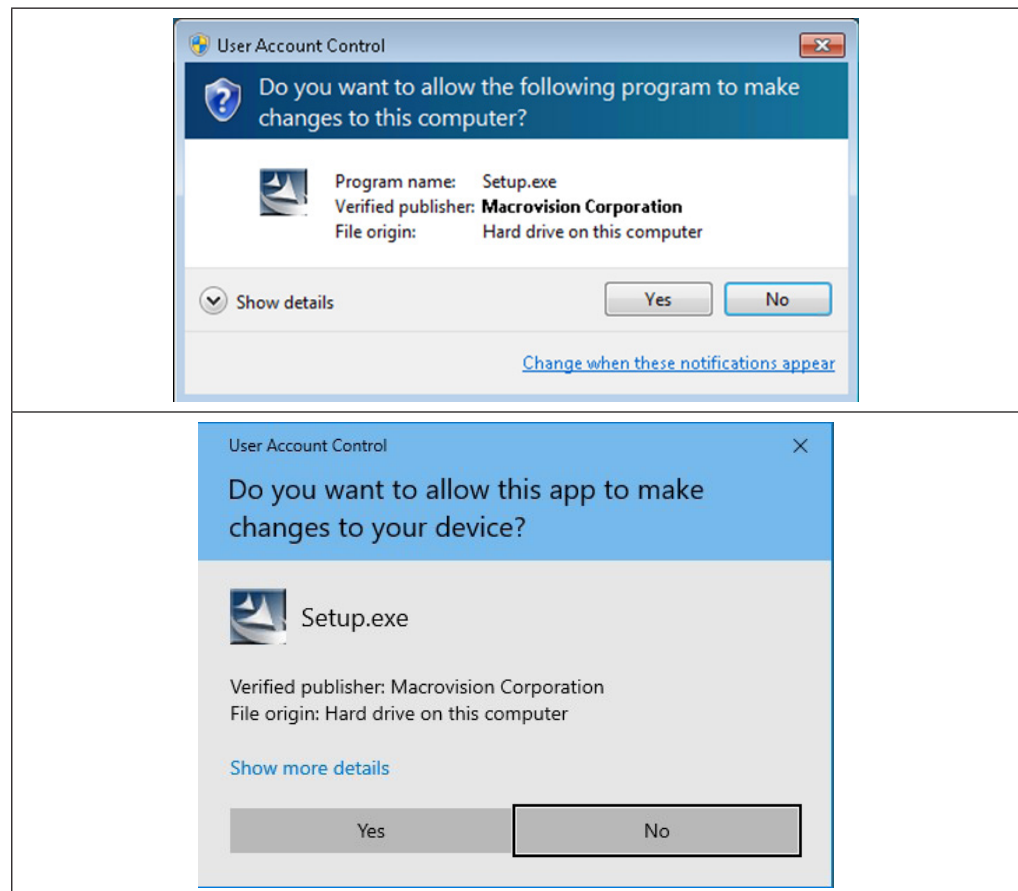

Reboot the device twice finish the switch to the Microsoft driver.

4.2 Windows Updates

The Windows Update service is disabled by KEB because it influences the realtime behavior of the system.

KEB recommends to enable the Enhanced Write Filter (EWF) for volume C:\ to protect the Operating System against any change and damage in productive phase, thus windows updates would be discarded anyway.

⚠ WARNING

Necessity of windows updates for security reasons depends on an overall concept of security for the field of application and is the responsibility of the user of this device.

4.3 EWF implementation in the Windows Embedded Standard 7 images

All the KEB Windows Embedded Standard 7 images have a built-in support for Enhanced Write Filter (EWF).

EWF protects a volume from write access.

Its two major components are the EWF Overlay and the EWF Volume:

- **EWF Overlay:** EWF protects the contents of a volume by redirecting all write operations to another storage location. This location is called an overlay. An EWF overlay can be in RAM, or on another disk partition. An overlay is conceptually similar to a transparency overlay on an overhead projector. Any change that is made to the overlay affects the picture as it is seen in the aggregate, but if the overlay is removed, the underlying picture remains unchanged.
- **EWF Volume:** In addition to the EWF overlay, an EWF volume is created on the media in unpartitioned disk space. This EWF volume stores configuration information about all of the EWF-protected volumes on the device, including the number and sizes of protected volumes and overlay levels. Only one EWF volume is created on your device, regardless of how many disks are in the system. If your media does not support multiple partitions, you can save the EWF configuration information in the system's registry (RAM Reg Mode, KEB's choice)

EWF was configured by KEB with the RAM Reg Mode to protect the C: volume. So, the overlay is in RAM and the EWF volume location is in system registry.

If EWF is activated, each write operation for C: is redirected to an overlay in the RAM memory. no data will be permanently stored into C.

In case of a reboot or of a system restart after a power failure, the overlay will be reset and all the data written in the previous session will be lost. The view of volume C: will be the same after each restart.

If no persistent volume C: is available, at least one other volume (a separate D: partition, another storage device, a network share) must be created that contains persistent data for the application.

This second volume will not be protected from power failures, but will not contain information that is vital for system booting.

On KEB Windows Embedded Standard 7 images, EWF is disabled by default at shipment and it must be enabled by the customer, in case it is needed.

4.4 KEB Write Filter Manager (KEB-WF_MGR)

4.4.1 Introduction

KEB Write Filter Manager bases on the Enhanced Write Filter (EWF) from Microsoft for Windows Embedded Standard 7 (WES7).

4.4.2 How EWF works

EWF protects a volume from write access. This is realized by an EWF overlay: EWF protects the contents of a volume by redirecting all write operations to another storage location. This location is called an overlay. An EWF overlay can be in RAM, or on another disk partition. An overlay is conceptually similar to a transparency overlay on an overhead projector. Any change that is made to the overlay affects the picture as it is seen in the aggregate, but if the overlay is removed, the underlying picture remains unchanged. When EWF is enabled for a volume, every write operation to that volume will be redirected to an overlay in RAM and no data will be persistently stored into the volume. In case of a reboot or of a system restart after a power failure, the overlay will be reset and all the data written in the previous session will be lost. The view of the volume will be the same, after every reboot. Thus the content of the volume is protected by any damage which can be caused by power fails otherwise.

4.4.3 Protectable Volumes

Volume	Protectable	Intention
C:\	Yes	Holds the operating system (including the registry) and the installed programs. Should be protected to ensure that the system never becomes unbootable.
D:\DATA	No	For free data storage, future use
E:\CFAST	Yes	Holds the Control and HMI applications. Should be protected to ensure that the applications never become invalid.

Table 2: Volume protection

4.4.4 KEB EWF configuration

On KEB devices RAM overlay is used and the EWF configuration is stored in the registry of the WES7 operating system, which resides with the operating system on volume C:\. This implies that changes to the EWF configuration are only possible if the EWF for volume C:\ is disabled or the changes to C:\ will be committed. Otherwise they will be discarded after a reboot. The following table shows the dependencies between the volumes:

		Registry Drive (holds the registry): C:\										
		Status	EWF enabled				EWF disabled					
		Boot Command	ENABLE	DISABLE	COMMIT	NO_CMD	ENABLE	DISABLE	COMMIT	NO_CMD		
Dependent Drive: e.g. E:\	Status	(Boot) Command										
	EWF enabled	Enable	in this state	for drive C:	not available in this state		for drive C:	in this state	state		in this state	
		Disable			x	-			x	x		
		Commit			x	x			x	x		
		Commit and Disable live			x	x ¹⁾			x	x		
	EWF disabled	Enable	not available	not available	x	-	not available	not available	not available	x	not available	x
		Disable			not available in this state					state		
		Commit			not available in this state					state		
Commit and Disable live		not available in this state			state							

x possible
 - not possible
 x¹⁾ possible, but EWF enabled again after reboot



These dependencies are handled by the KEB_WF_Mgr internally. Therefore it is not necessary to understand this table completely or to use it as a reference when using the EWF. But keep in mind that there are dependencies because some internal operations of the KEB_WF_Mgr has to be confirmed by the user.

4.4.5 Delivery state of EWF on KEB devices

On KEB Windows Embedded Standard 7 image, EWF is disabled by default at shipment because some settings has to be made on the drive respective in the registry by the user (e.g. IP address setting).

Every time WES7 starts with EWF disabled for volume C:\ the user is reminded to enable the EWF by the following message box:

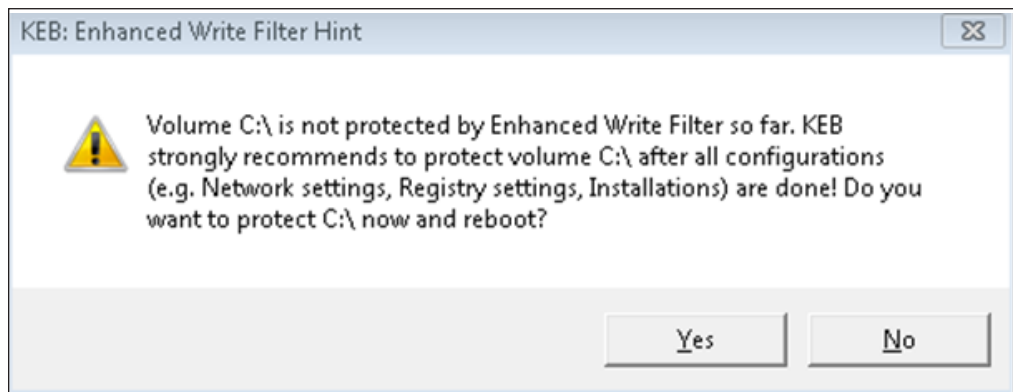

After all settings to the registry are done you can directly activate the EWF for volume C:\ by clicking 'Yes'. The device will reboot immediately and the EWF is enabled for volume C:\.

If you click "No" the message box is closed but will be appear again after the next reboot.

Please note that the volume E:\ which holds the application data is not protectable by this way.

4.4.6 Using KEB_WF_Mgr

To disable EWF or to enable it for other volumes, KEB_WF_Mgr should be used (the use of the command line program “ewfmgr” from Microsoft is not recommended by KEB).

Start the KEB_WF_Mgr by double-click the icon on the desktop:



Then the desktop link will start the program which resides in the path „C:\Program Files\KEB\PCTools“.

The program needs “elevated rights”. Please confirm the question from the User Account Control with “Yes”:

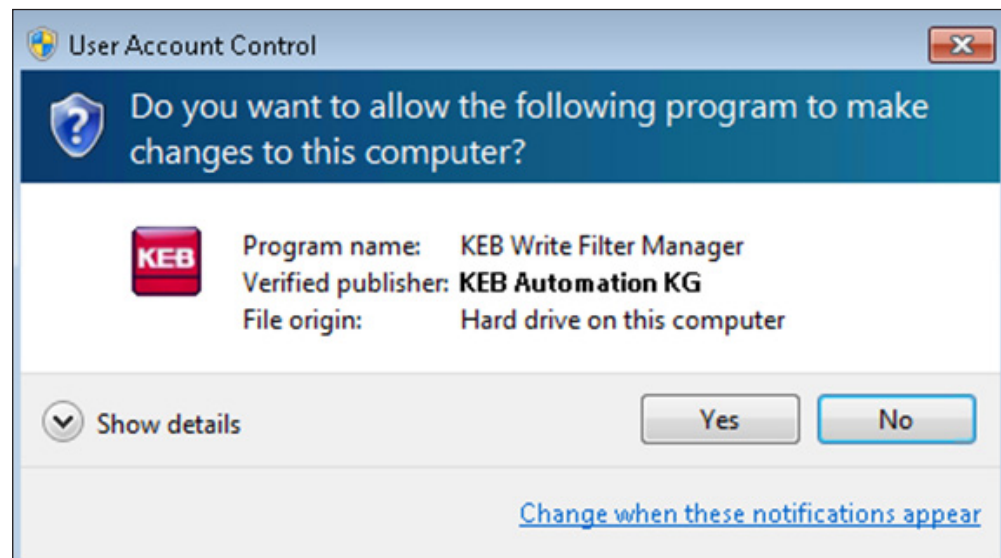

The program’s GUI appears with volume C:\ (provided that EWF for volume C:\ has already been activated before).

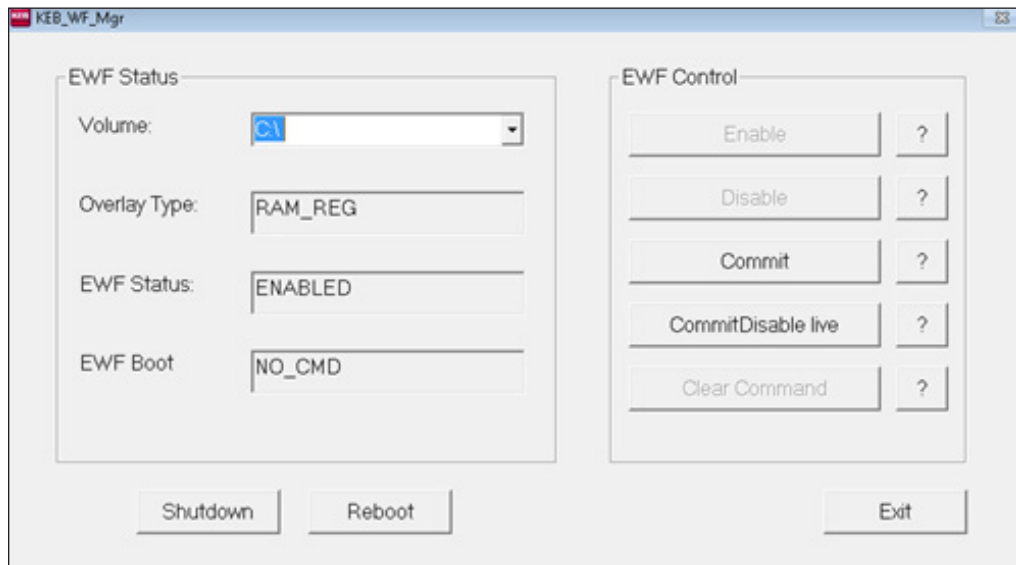

Under the Volume: you see the states of the selected volume as read-only fields:

- Overlay Type: On KEB devices always RAM-REG
- EWF Status: Current status of the EWF
- EWF Boot: Command which will be performed with the next reboot

On the right side you see the EWF Control commands, each with a help button aside (the commands which are not available in the current constellation are greyed and disabled):

- **Enable:** Enables a currently disabled overlay on the specified EWF-protected volume. This function requires a reboot.
- **Disable:** Disables a currently enabled overlay on the specified EWF-protected volume. This function requires a reboot.



This function is not available at all for the volume C:\ which holds the registry, because the change in the registry for the new state of EWF cannot become persistent. Use 'CommitDisable live' instead to disable EWF for C:\

- **Commit:** Commits all current level data in the overlay to the EWF-protected volume. This function requires a reboot. After the reboot the EWF status of the volume is still "ENABLED".
- **CommitDisable live:** Immediately commits all current level data to the EWF-protected volume and then disabled EWF. This function does NOT require a reboot.

⚠ WARNING

All changes on the volume since the last reboot become effective. Do not execute this if you are not sure about the extent of the changes.

⚠ WARNING

The changes become effective immediately with reboot. It is not possible to undo this command with "Clear Command".

- **Clear Command:** Clears a pending command for the volume that would have occurred on the next restart.

4.4.7 Dependent Volumes (typically E:\)

As mentioned above, other volumes (in the following, typically E:\ which is the CFast on KEB devices) are dependent from volume C:\ to change their configuration because they are stored in the registry located on C:\ and thus the registry is protected against any changes, if EWF is activated for C:\

If EWF is deactivated for C:\ all commands for the dependent volumes can be used independently.

Otherwise, if EWF for C:\ is enabled, the following rules are effective:

- **Enable and Disable:** if one of these commands is used the following message box asks if the Commit command for C:\ should also be set. It is recommended to confirm with "Yes" because otherwise the Enable or Disable has no effect. The message is not displayed if the boot command for C:\ "Commit" is already present.

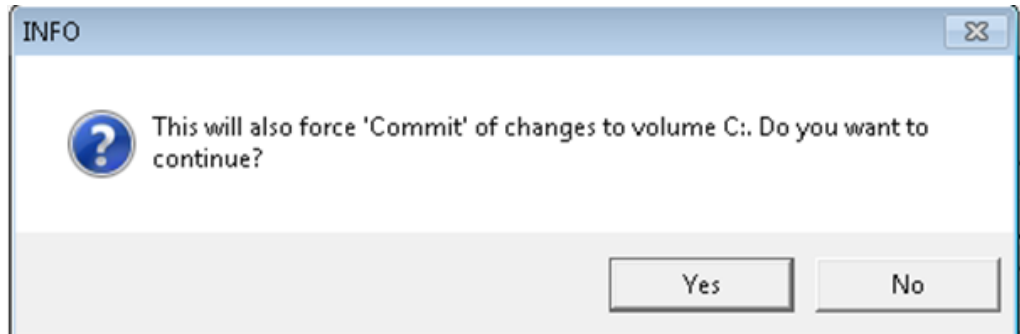

- The **Clear Command** can reset the Commit without any dependency, but for Enable/Disable it asks to clear the implicitly set of Commit for volume C:\, too:

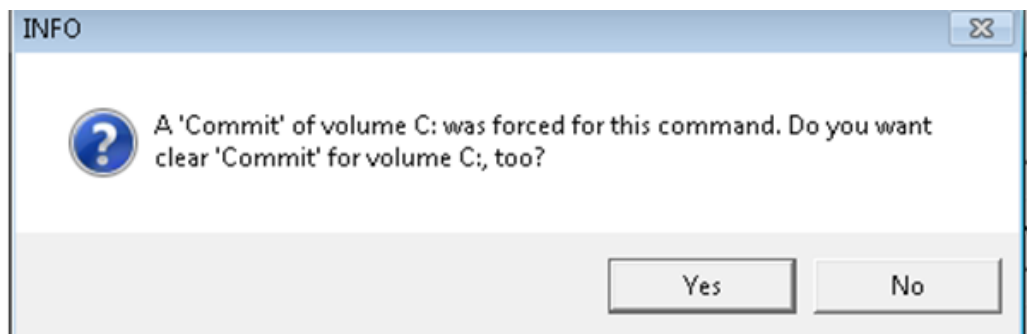

Normally you should confirm with "Yes" because the Commit for volume C:\ was only set to take effect for the change of E:\.

4.4.8 Leave the KEB_WF_Mgr

A Shutdown or Reboot of the device can be initiated directly from the KEB_WF_Mgr to take effect for pending boot commands by using the particular buttons.

The program can also be left by the Exit button. In this case the program checks for pending boot commands and shows if appropriate the following message box:

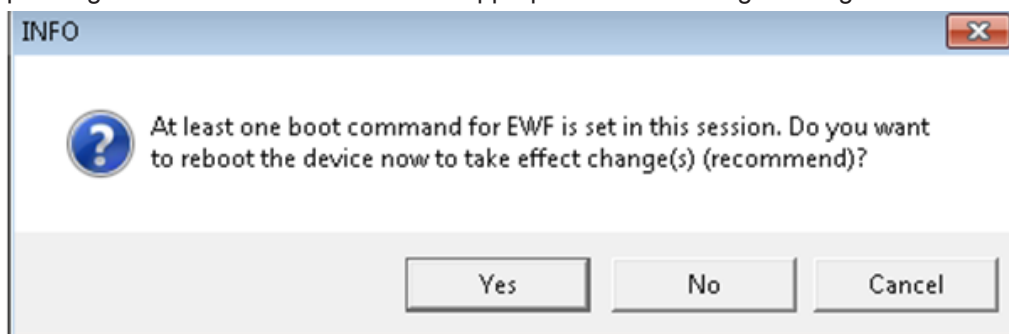

It is recommended to choose “**Yes**” to ensure that no subsequent changes of the system are committed accidentally; which could be happened if you quit the message box with “**No**”.

If you choose “**Cancel**” the exit of the program is discarded and you can continue to work in the KEB_WF_Mgr.

4.5 KEB UWF Manager

4.5.1 Introduction

The KEB UWF Manager offers a simple interface to use Microsoft's Unified Write Filter in Windows 10.

4.5.2 Functioning of the UWF

UWF protects your volume from write access by redirecting all write commands to a virtual overflow. The virtual overflow is a temporary memory, which is either in RAM or directly on the volume and which is cleared when the device is restarted. Any change made to the overflow affects the image, but if the change is undone, the image remains unchanged.

If the UWF is enabled for a volume, no data are permanently stored on this volume. In case of a restart or power failure, the overflow will be reset and all data from the previous session will be lost. The view will be the same after each reboot and is therefore protected against damage that can be caused by a power failure.

4.5.3 KEB UWF Configuration and usage

To protect the system on volume C:\ including the registry, the overflow is configured with 4096 MB on the hard disk as standard.

KEB recommends the use of a write filter in order to increase the longevity of the devices and the data integrity. UWF Manager is disabled at the time of delivery, in order that the user can make changes during the start-up process.

Each time the device boots up with disabled UWF, the user is reminded to activate the write filter. As soon as the start-up is completed, the user can activate the write filter directly by clicking "Yes".

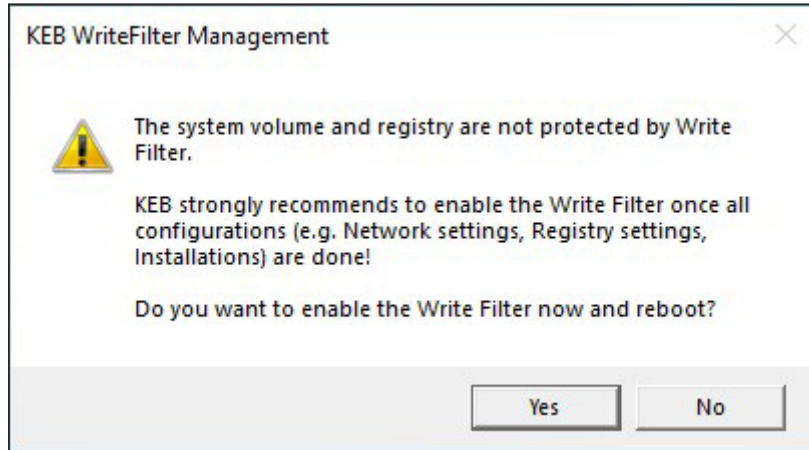

To activate the UWF Manager or to display more information about the current protection status, the KEB UWF Manager should be used, because it provides a more intuitive configuration option compared to the command line tool provided by Microsoft.

A shortcut to the KEB UWF Manager can be found on the desktop and can be executed by double click. Please note that this tool requires elevated rights, the popup window of the user account control must be confirmed with "Yes".

The program interface appears and you can protect (Protect) or not protect (Unprotect) your system. Furthermore, after activating the write filter, the overflow info (Overlay Info - Current) is displayed including type, maximum size and current usage.

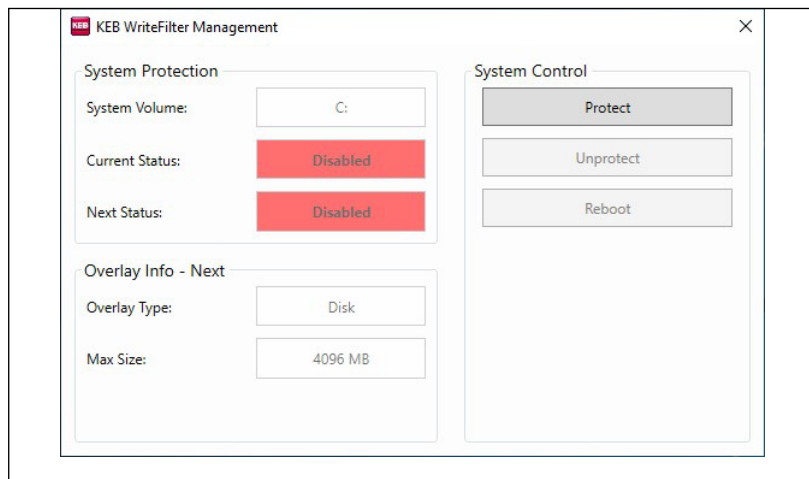

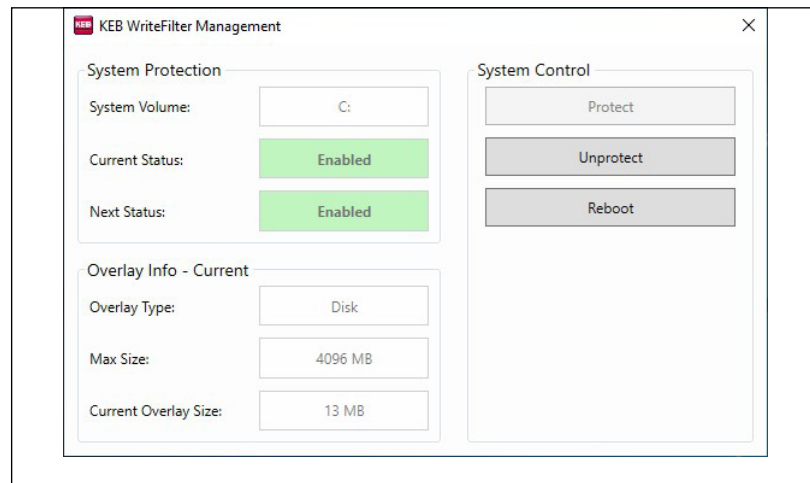

Depending on the current status of the UWF Manager, the user can protect or unprotect the system by using the buttons on the right. Both actions require a restart. If the state has changed, the "Reboot" button can be used to restart the system and to activate the set state.

In case of a state change without restart, the tool reminds the user to restart the system when leaving.

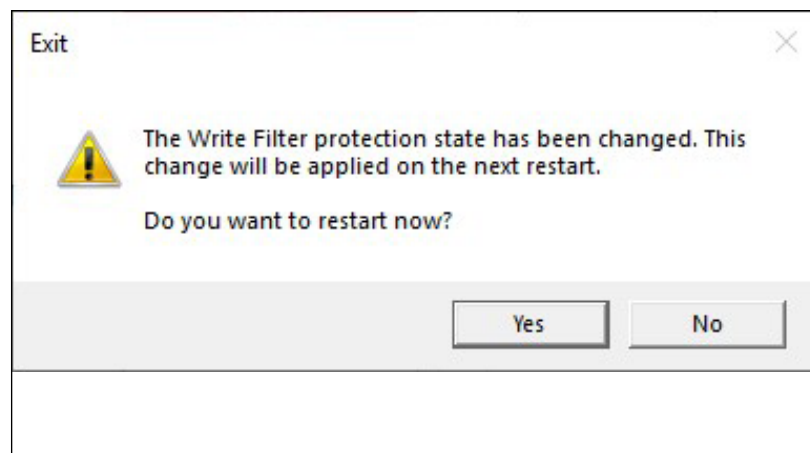

4.6 KEB Linux Image

4.6.1 Introduction

KEB has created a Linux image for C6 E22 / P3x with special features that support you in the work with the device.

4.6.2 Service User Accounts

KEB Linux image has got a service account which can be used to change device settings.

Account	service
Password	service

After login to the device with the service user account the following menu is shown:

```
C6E22LX login: service
Password:
Last login: Tue Oct 29 10:13:22 2019
Welcome to service shell of host: C6E22LX

Please, select operation from list below:
 1) Show/change IP address
 2) Change hostname
 7) Show version information
 8) Change password
 9) Reboot PLC
 0) Exit
```

WARNING

The default password for the service user account should be changed to an individual password for security reasons!

The C6 E22 / C6 P3x Linux is configured to use the IP address 192.168.0.100. This also makes it possible to set up a remote connection to the device with a development PC, e.g. if no display unit is available. To do this, configure the Ethernet adapter of the development PC with another address 192.168.0.xxx and connect to the device with Putty as service user:

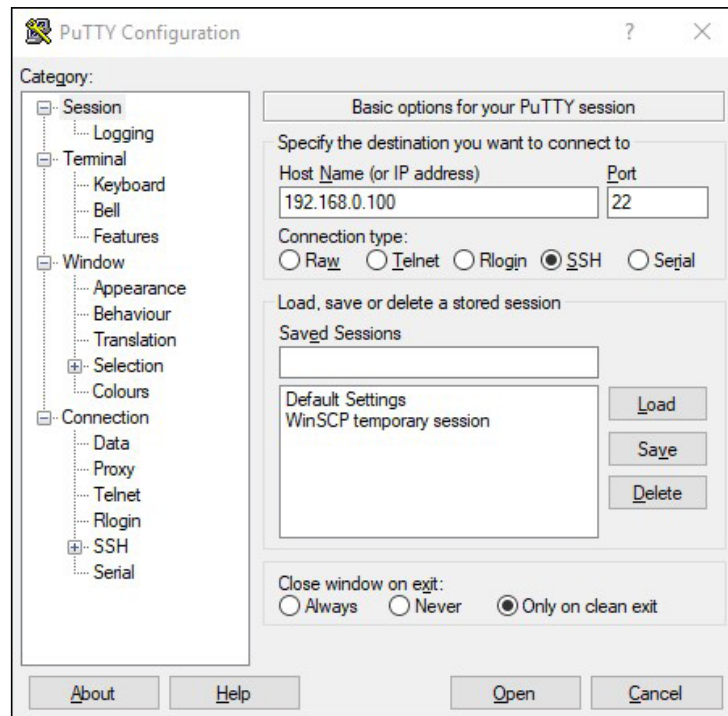

4.6.3 Change password for service user

To change the password, proceed as follows:

- Login as user “service”
- Select menu “8) Change password”
- Follow the instructions:
 - Enter old password
 - Enter new password twice. It must fulfill conditions regarding length and complexity
- Reboot the device

4.6.4 Ethernet IP Address

To switching the Ethernet address the service user menu “1) Show/change IP address”. The current IP address is shown and following sub menu occurs:

```

Current IP address: 192.168.0.100
Changing IP address:
  1) Switch network to DHCP
  2) Switch network to default static IP
  3) Switch network to static IP
  0) Back to main menu
    
```

Choices:

1.	Switch network to DHCP, to switch to dynamic network configuration (DHCP).
2.	Switch network to default Static IP, to switch to default static IP 192.168.0.100/24.
3.	Switch network to static IP for static network configuration.

The set e.g. the IP address 172.17.131.100 and the mask 255.255.255.0 must be entered as followed:

172.17.131.100/24

The value 24 for mask means 24 set bits in the mask beginning from left. Accordingly, 8 bits on the right are not set.

4.6.5 Usage of storage memories

The C6 E22 / P3x Linux is delivered with two hard disk drives, a SSD and a CFast card. On the SSD the Operating System and the runtimes (Control, CNC Kernel etc.) are located. The applications and data are separated and located on the CFast. Because the CFast is easy to remove the applications can be transferred to an exchange device easily.

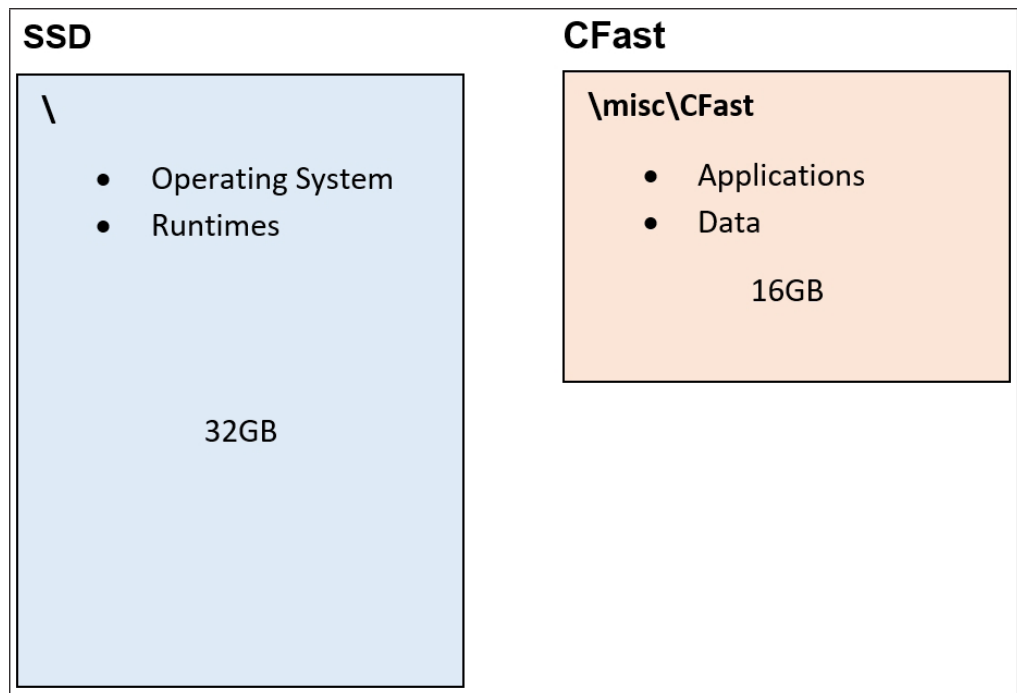

4.7 Common (Windows and Linux)

4.7.1 Micro-UPS Handling

As also mentioned in the hardware related parts of this manual all C6 E22 / P3x devices are equipped with a micro-UPS to ensure storage of Retain and Persistent variables of the Control application in case of power lost.

To avoid inconsistent data sets, the Retain and Persistent variables will be stored only if the μ USV is charged completely. Otherwise the capacity could not be sufficient to store all variables and the consistency of the data set cannot be ensured.

The charging time of the micro UPS is about 15 s for C6 E22 / P3x devices, thus normally the micro UPS is always charged until the Control application is started after a restart of the device. But for security and to keep the Control application easy portable to devices this longer charging time the charging level should be evaluated in the Control application.

For this an “Internal I/O Mapping” named “IoDrvUPS” is automatically available with the C6 E22 / P3x device in KEB COMBIVIS studio 6.

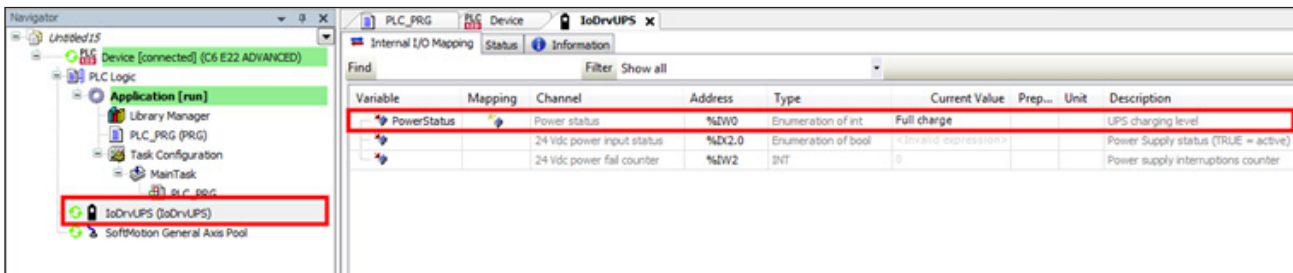

To evaluate the „Power status” inside the Control application a variable has to be defined, e.g. „PowerStatus“.

The values of Power status are:

0	Unit isn't available (must not appear on functional C6 E22 / P3x)
1	Low charge
2	Half charge
3	Full charge

The Machine application should wait until the micro-UPS is fully charged before any operation is performed which changes Retains or Persistents. This can be achieved with an implementation comparable with the following example:

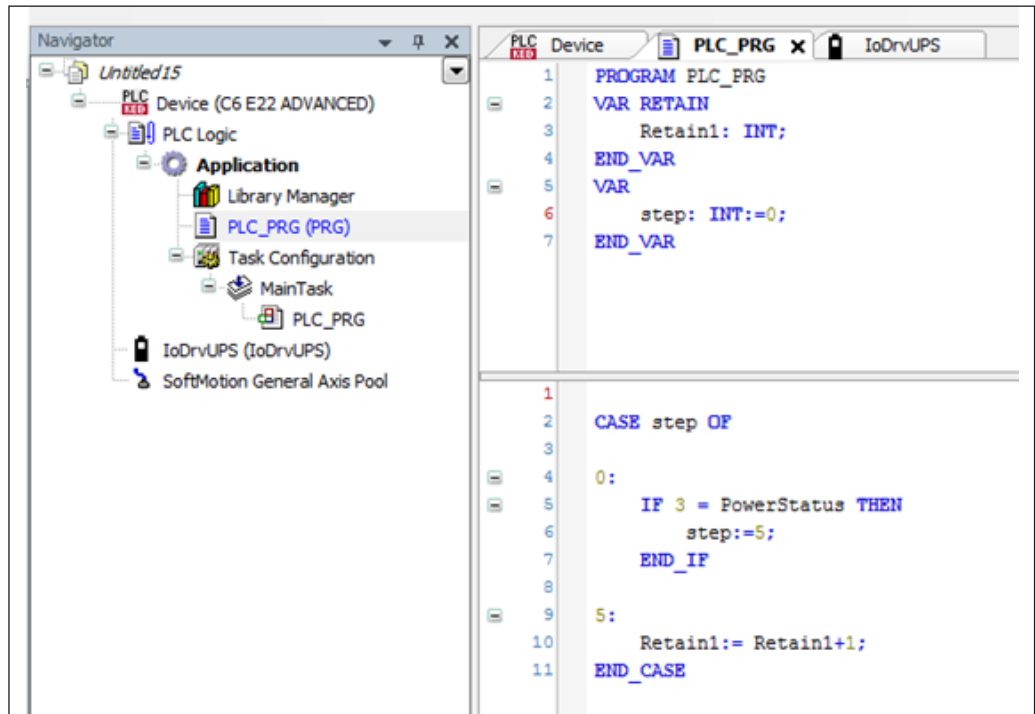

The other “Internal I/O Mapping” variables “24 Vdc power input status” and “24 Vdc power fail counter” cannot be used in a sensible manner, because the PLC is configured to stop after a short voltage drop already.

4.7.2 Ip-Scan

Ip-Scan is an IP address scanner from KEB to find other KEB devices in the network. This requires that Ip-Scan runs also on the device which should be found. The C6 E22 / P3x should be detectable by the Ip-Scan (also integrated in COMBIVIS studio 6). The Ip-Scan starts automatically after booting on the device.

Ip-Scan is not yet available on C6 E22 / P3x Linux!

4.7.3 Serial interface

The C6 E22 / C6 P3x can be equipped with an (optional) serial interface (COM ports). The following table gives an overview:

	C6 E22		C6 P33	C6 P34
	Bookmount	Panel/Box		
COM1	----	RS232	----	RS232
COM3	opt. RS232/ RS422/RS485	opt. RS232/ RS422/RS485	opt. RS232/ RS422/RS485	opt. RS232/ RS422/RS485

By default the COM port is configured to the RS232 protocol. RS422/RS485 is also possible for some devices.

In order to enable activate ports and to switch the protocol setting, it is necessary to enter the BIOS. This is done by pressing the "F2" key during start-up. You can change the settings by navigating to "Advanced/Super IO Configuration" for C6 E22 or "Advanced/F81866 Super IO Configuration" for C6 P3x. There you find the settings for the COM ports.



The names of the COM ports differ within the BIOS. In the C6 E22 BIOS, "COM1" is designated as "COM A" and "COM3" as "COM C". In C6 P3x BIOS, COM ports are called "Serial Port x", but with the same number.

Navigate to the "Mode" setting for the COM port and change it to "RS422" or "4-Wire RS485". Leave the BIOS with "F10" key to save the changes.

In Windows and/or the COMBIVIS studio 6 application no changes are necessary.

5 Maintenance and service

5.1 Removing the left side cover

Tool required	Action
	Screw / unscrew fixing screws
Plastic screwdriver	

Turn off the system and disconnect the power supply.

On the side of the system remove the 3 fixing screws of the cover.

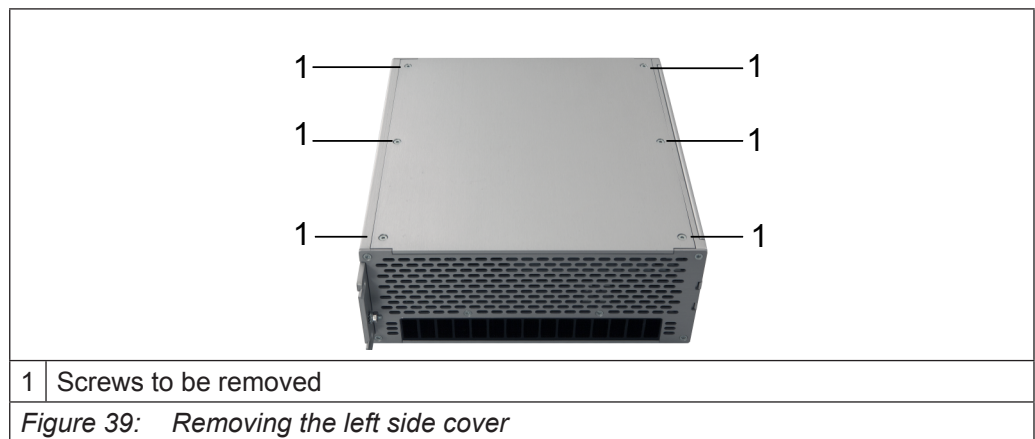

5.2 RAM installation / removal

Locate the RAM module.

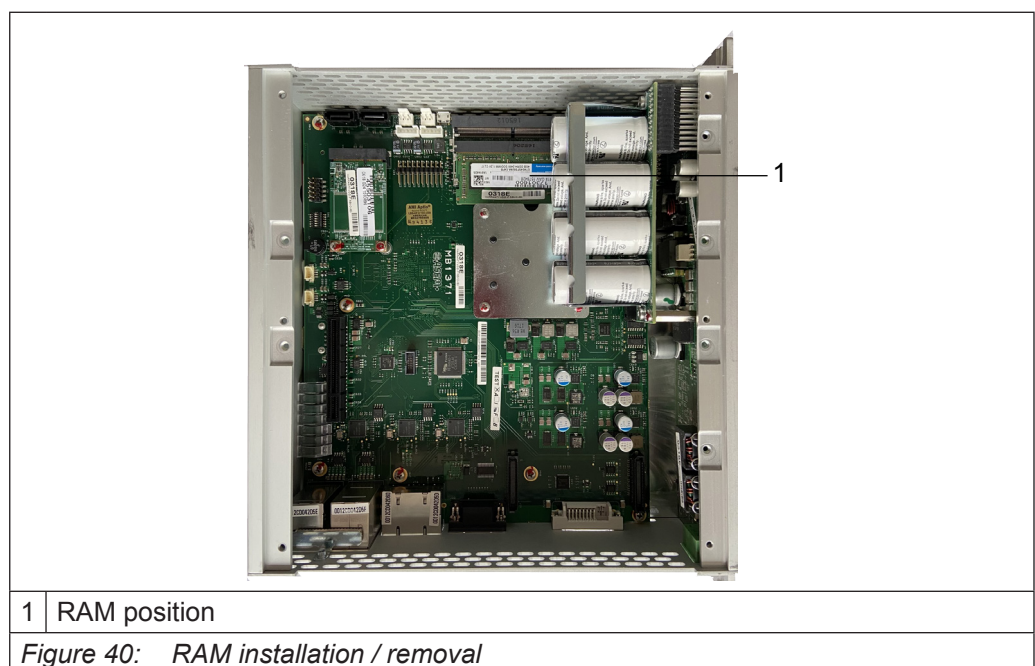

Expel the module by slightly opening the side fastening tabs of the plinth.

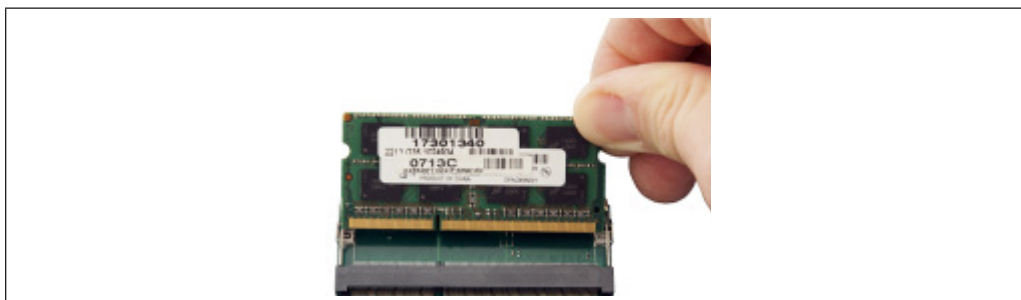

Figure 41: RAM installation / removal

For reinsertion, check the correct polarity of the module. When insertion is complete, check for proper closure of the side fastening tabs.

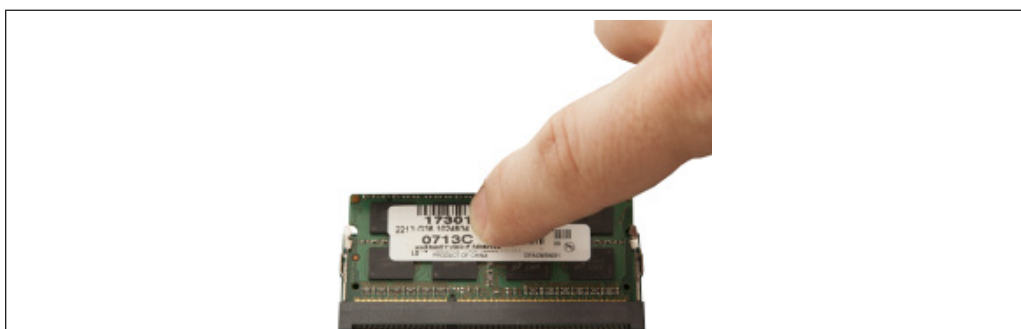

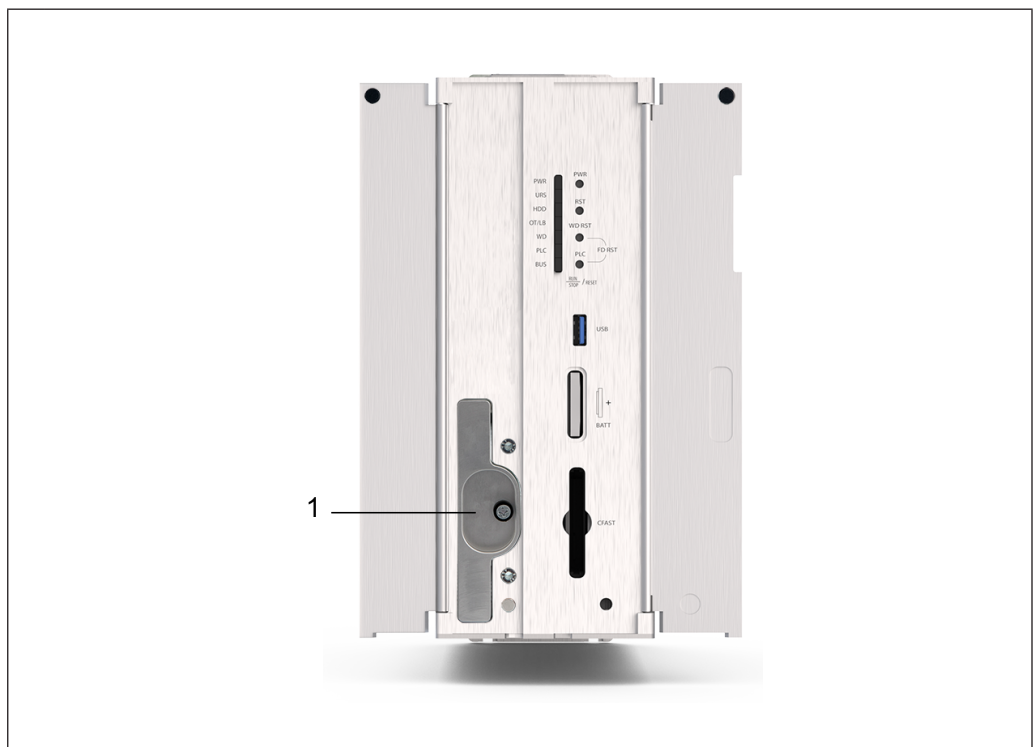

Figure 42: RAM installation / removal

5.3 Extractable disc installation / removal

Tool required	Action
	Screw / unscrew n.5 fixing screws
Plastic screwdriver	

Unscrew the drawer fixing screw.



1 | Drawer fixing screw

Figure 43: Extractable disc installation / removal

Extract the drawer.



Figure 44: Extractable disc installation / removal

Remove the 4 mounting bracket fixing screws.

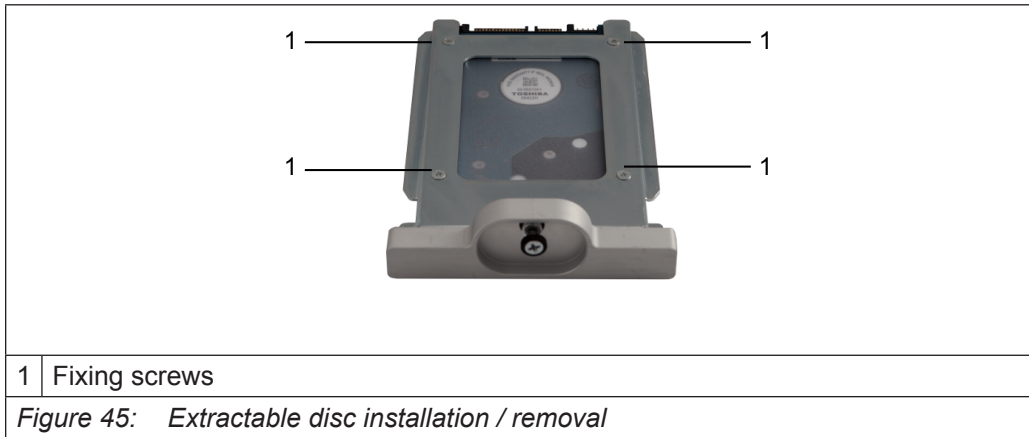

To reinstall follow the procedure backwards.

5.4 Battery installation / removal

Tool required	Action
	Pull the battery holder.
Plastic screwdriver	

- Turn off the system and disconnect the power supply.
- Using a screwdriver (not provided) carefully pull out the battery holder.



Figure 46: Battery installation / removal



Figure 47: Battery installation / removal

- Remove the battery and replace it with one of the same model (Lithium CR2032 3V Coin).



Figure 48: Battery installation / removal

- Re-insert the battery holder with the new battery. Check for correct polarity.

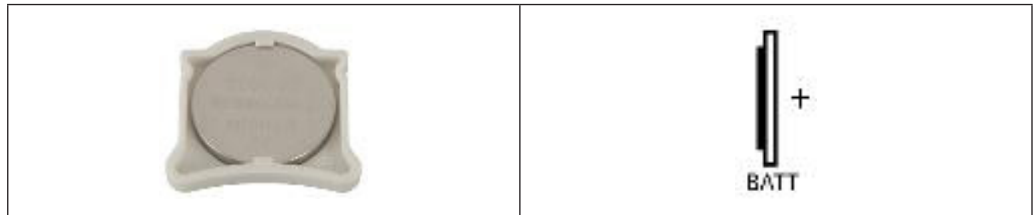

Figure 49: Battery installation / removal

5.5 CFast installation / removal

- Turn off the system and disconnect the power supply.



Figure 50: CFast installation / removal

- Insert the memory card into the slot as indicated in the figure. Pay attention to the beveled edge.
- Push the card all the way.

5.5.1 Removal

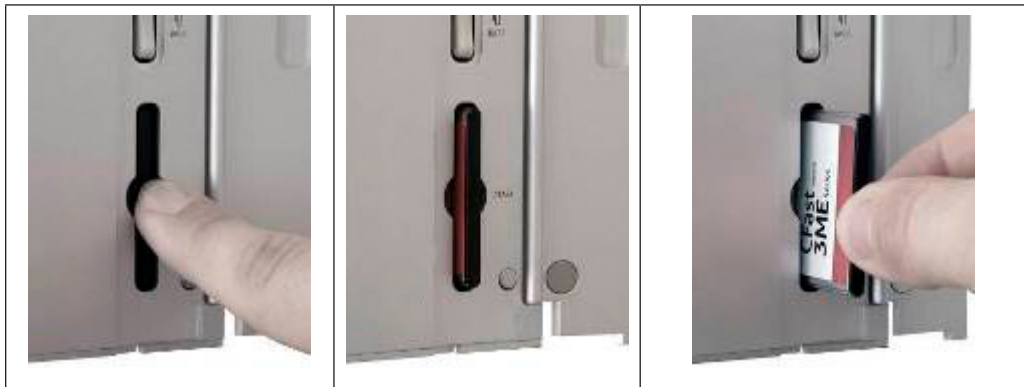

Figure 51: CFast installation / removal

- Push and release the memory card as indicated in the figure.
- Extract the memory card from the slot.

5.6 Maintaining and cleaning

C6 P34 BM is designed for maintenance-free operation except for the replacing of the battery backup when necessary. It is recommended to clean the touchscreen with a damp cleaning cloth and a display cleaning solution.



Clean the front panel of the system with a soft damp cloth only.

5.6.1 Procedure

Proceed as follows:

- Switch off the C6 P34 BM device or lock the touch screen.
- Spray the cleaning solution onto a cleaning cloth.
- Do not spray directly onto the display.
- Clean the display from the screen edge inwards.

5.7 Technical support and repairs

KEB offers wide-ranging, complete after-sales technical support. The staff who deal with this handle questions on the entire range of products skillfully, quickly, and efficiently.

You can phone our staff in the service department, and they will give you complete, prompt advice on how to resolve your problems.

KEB Automation KG
 Suedstrasse 38
 32683 Barntrup, Germany
 telephone +49 5263 401-0
 fax +49 5263 401-116
 e-mail: COMBICONTROL@keb.de

5.8 Recycling and disposal

C6 P34 BM can be recycled due to the use of materials with low environmental impact. Contact a certified disposal service company for environmentally sound recycling and disposal of your old devices.

6 Technical specifications

6.1 Block Diagram

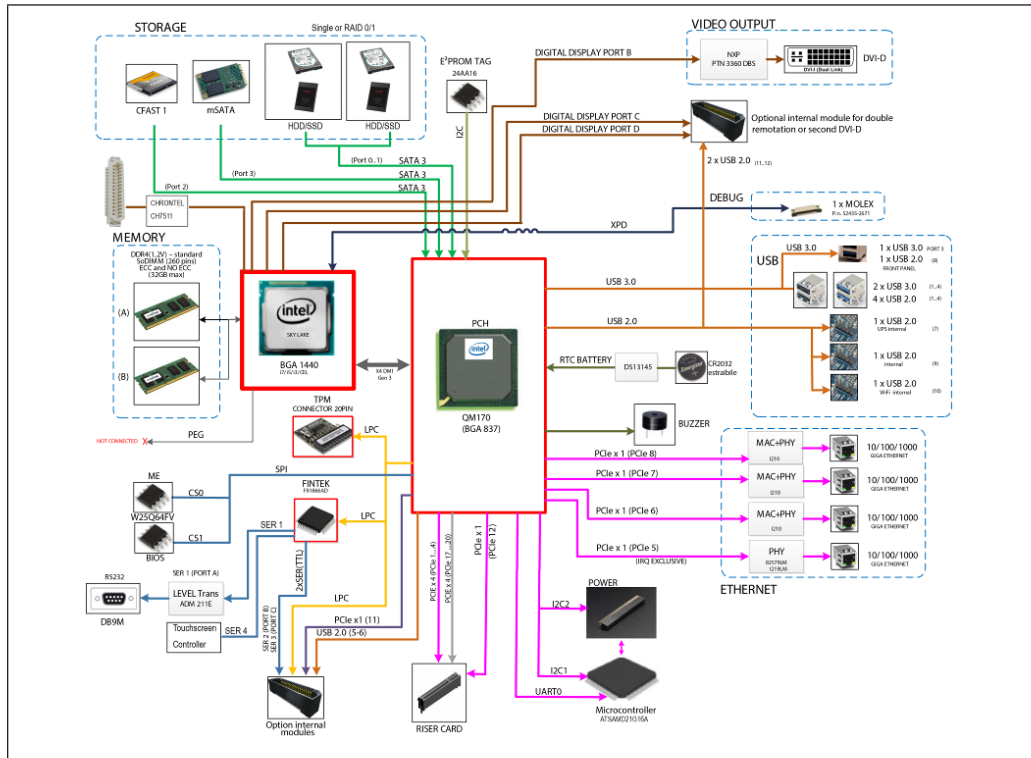

Figure 52: Block diagram

6.2 C6 P34 BM S0 - Technical data

Case	Wall book mount
Power supply	24V DC Input voltage: 18÷32V DC Isolated
Motherboard	Type "All-In-One" KEB 1371
Watchdog	Time programmable
Processor	Intel® Core™ i5-6440EQ ▪ 2,70 GHz (3.40 GHz Turbo) ▪ 6MB smart cache ▪ 4 cores, 4 threads ▪ Soldered on-board
Chipset	Intel® HM170 PCH (Platform Controller Hub)
RAM memory	DDR4-2133 type ▪ 2 SODIMM modules ▪ min 4GB ▪ max 32GB
Operating System certified by KEB	Microsoft Windows Embedded Standard 7P 32. Other operating systems, such as VxWorks, QNX, etc., have not been certified by KEB but they are reasonably supported by the Intel platform after verification of compatibility.
Operating System not supported by Intel platform	Microsoft Windows XP / 2000 / 98 / Microsoft Windows CE 5 / 6
Software Remote assistance	KEB COMBIVIS CONNECT runtime license with KEB sticker.
Video controller	Intel® HD Graphics 510 integrated into Intel® Celeron™ microprocessor ▪ 950MHz
	Intel® HD Graphics 530 integrated into Intel® Core™ microprocessor ▪ 950MHz / 1GHz
Video RAM (shared)	Dynamic Video Memory Technology ▪ Memory quantity is automatically selected by operating system (max 1720 MB)
System memory	DDR4-2133 type ▪ 2 SODIMM modules ▪ min 4GB ▪ max 32GB
Mass storage interfaces	1 x SATA III, 6Gb/s 1 x mSATA SATA III, 6Gb/s
RAID controller	Integrated into chip Intel® HM170 PCH ▪ Raid 0, 1
TPM	2x10 (2,54) Pin-strip connector for optional TPM module
Front signaling (LED)	Power ON ▪ UPS ▪ HDD activity ▪ Over temperature / Battery fault ▪ Watchdog / Reset factory default

TECHNICAL SPECIFICATIONS

Front buttons (door open)	Power ON ▪ System Reset ▪ Watchdog Reset ▪ Factory Default Reset	
On Top I/F	4 x Ethernet 10/100/1000 Mbps (RJ45) 3 x Intel® I210, 1 x Intel I219LM 2 x USB 3.0 (Type A) 2 x USB 2.0 (Type A) 1 x RS232 (DB9M) 1 x DVI-D Single Link (max resolution: 1920x1080 FullHD)	
Optional	1 or 2 x RVL OUT (RJ45), remotation (TX) up to 100 m of video DVI-D and USB 2.0 signals	
On Front I/F (with open front door)	1 x slot CFast (bootable) ▪ 1 x system battery slot (CR2032) ▪ 1 x USB 3.0	
Environmental specifications	Operating temperature:	0°C÷+50°C 0°C÷+45°C with 24x7 HDD or with Core i7 processor +5°C÷+45°C with standard HDD
	Storage temperature:	temperature: -10° ÷ +60°C ▪ Humidity: 80% (noncondensing)
<i>Table 3: C6 P34 BM S0 - Technical data</i>		

Options	D0	D1	D2	
TPM	•	•	•	TPM – Trusted Platform Module
CFAST	•	•	•	CFAST SATA
SSD mSATA	•	•	•	SSD mSATA, SATA III, 6Gb/s (Solid State Disk), MLC
SSD 2,5"	•			1 x SSD 2,5" SATA III internal installation kit (SSD not included)
		1	2	1 x SSD 2,5" SATA III extractable drawer (SSD not included) > note 2
	•	•	•	SSD 2,5" SATA
Communication ports	•	•	•	1 x RS232/422/485 (DB15M) isolated 1 x USB 2.0 > note 3
REMOTE Video Link	•	•	•	1 x additional video output RVL - Remote Video Link Remotation up to 100m of DVI-D and USB 2.0 signals ▪ without cables > note 4

Table 4: Options

Note 2	The D1 version allows the installation of 1 extractable drawer kit.
Note 3	Communication boards cannot be installed together.
Note 4	RVL option is in addition to the DVI-D video output on the motherboard, let the installation of max 1 extractable drawer and have to be connected to a C6 Monitor or C6 AMM monitor.

6.2.1 Power supply technical data

The power supply board is provided with a FAST FUSE 12A SMD.
 The fuse can be replaced only in factory.

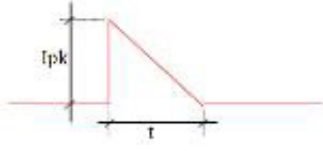
Power supply	
Type	Isolated DC-DC
Isolation voltage	500 VAC
Input voltage	18÷32V DC
Input protection	Reverse polarity circuitry Overvoltage 12A soldered fuse
Power consumption	150W @ 24V (100W Typ)
Inrush current impulse I _{pk} : < 13A t: 2.0 ms	 <p>The graph shows a red line representing the inrush current. It starts at zero, rises sharply to a peak labeled I_{pk}, and then decays linearly to zero over a time interval labeled t.</p>
<i>Table 5: Power supply technical data</i>	

6.2.2 System power consumption

In order to calculate the system power consumption it is necessary to add one item for every field of the following tables.

Field	Item	Consumption (W)
C6 P34 BM (S0) D0 basic system	Intel® Celeron® dual core G3900E 2,40 GHz ▪ 4GB RAM ▪ fanless ▪ COMBIVIS CONNECT runtime ▪ without predisposition to extractable drives ▪ 24V DC isolated power supply ▪ without UPS	56.0
C6 P34 BM (S0) D1 basic system	Intel® Celeron® dual core G3900E 2,40 GHz ▪ 4GB RAM ▪ fanless ▪ COMBIVIS CONNECT runtime ▪ with pre-disposition to 1 extractable drive ▪ 24V DC isolated power supply ▪ without UPS	56.0
Processor	Intel® Core™ i5-6440EQ ▪ 2,70 GHz (3.40 GHz Turbo) ▪ 6MB smart cache ▪ 4 cores, 4 threads ▪ Soldered onboard	+ 0,0
RAM	4 GB ▪ 1 module SODIMM DDR4-2133	-
	8 GB ▪ 2 x 4 GB modules SODIMM DDR4-2133	+ 1.0
	16 GB ▪ 2 x 8 GB modules SODIMM DDR4-2133	+ 2.0
	32 GB ▪ 2 x 16 GB modules SODIMM DDR4-2133	+ 3.0
TPM	TPM - Trusted Platform Module	0.0
CFast	CFast SATA	1.0
SSD mSATA	SSD mSATA, SATA 3, 6Gb/s (Solid State Disk), MLC	2.0
SSD 2,5" > note 2	SSD 2,5" SATA 2, 3Gb/s (Solid State Disk), MLC	5.2
COMMUNICATION PORTS > note 3	1 x RS232/422/485 (DB15M) isolated ▪ 1 x USB 2.0	2.6
Remote VIDEO LINK > note 4	1 x additional video output RVL - Remote Video Link ▪ Remotation up to 100m of DVI-D and USB 2.0 signals ▪ without cables	3.0

Table 6: System power consumption

Note 2	The D1 version allows the installation of 1 extractable drawer kit. The D2 version allows the installation of 2 extractable drawers kit.
Note 3	Communication boards cannot be installed together.
Note 4	RVL option is in addition to the DVI-D video output on the motherboard, let the installation of max 1 extractable drawer and have to be connected to a C6 Monitor or C6 AMM monitor.

6.3 Battery technical data



Figure 53: Battery CR2032 detail

Model	CR2032 MFR renata
Chemical System	Li / MnO ₂
Nominal Voltage	3 V
Rated Capacity	225 mAh
Temperature Range	-30°C - +70°C
Self Discharge at 23°C	< 1% / year

Table 7: Battery technical data

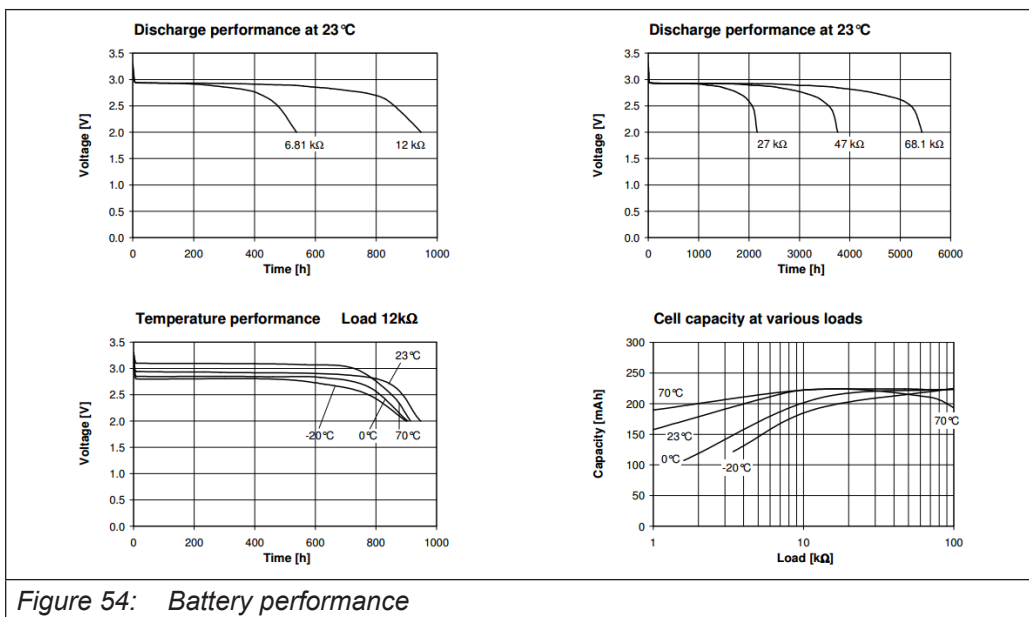

Figure 54: Battery performance

7 Certification

7.1 Mark of conformity

The original EC-Declaration of Conformity and the associated documentation can be made available to the competent authorities. Please contact the Project Management, as necessary.

EU DECLARATION OF CONFORMITY

Document No. / month.year: ce_ca_remv-C6H-b_en / 01.2019

Manufacturer:	KEB Automation KG Südstraße 38 32683 BARNTRUP Germany	
Product type	Control type Control size	yy C6H xx – xxxx yy = 00 for Stand Alone PC or yy = 10 to FF for TouchPanel PC x = any letter or number
	Voltage category	24 Vdc

The above given product is in accordance with the following directives of the European Union

Number:	EMC : 2014 / 30 / EU
Text:	Directive on the approximation of the laws of the Member States relating to electromagnetic compatibility.
Number:	Hazardous Substances: 2011 / 65 / EEC (incl. 2015 / 863 / EU)
Text:	Directive on the approximation of the laws of the Member States relating on the restriction of the use of certain hazardous substances in electrical and electronic equipment.

Responsible:	KEB Automation KG Südstraße 38 32683 BARNTRUP
Place, date	Barntrup, 28. December 2018
Issued by:	

 i. A. W. Hovestadt / Conformance Officer

 W. Wiele / Technical Manager

This declaration certifies the conformity with the named directives, but does not contain any assurance of quality.

The safety instructions, described in the instruction manual are to be followed.

KEB Automation KG, Südstr. 38, D-32683 Barntrup www.keb.de E-Mail: info@keb.de Tel.: +49 5263 401-0 Fax: -116

EU DECLARATION OF CONFORMITY



Annex 1

Document-No. / month.year: ce_ca_remv-C6H-b_en / 01.2019

Product type	Control type	yy C6H xx – xxxx
	Control size	yy = 00 for Stand Alone PC or yy = 10 to FF for TouchPanel PC x = any letter or number
	Voltage category	24 Vdc

The conformity of the above given product to the European Directive 2014/30/EU (for electromagnetic compatibility) is given by complete approval / testing to the following European harmonized standards. For not exceeding the required limits or minimum levels of immunity it is necessary to use observe the given wiring specifications from available instruction manual.

EN - Norm	Text
EN 55032 Version 2015	Electromagnetic compatibility of multimedia equipment – Emission Requirements
EN 61000 – 3 – 2 Version 2014	Electromagnetic compatibility – Part 3-2 Limits – Limits for harmonic current emissions (equipment input current ≤ 16A per phase)
EN 61000 – 3 – 3 Version 2013	Electromagnetic compatibility – Part 3-3 Limits – Limits of voltage changes, voltage fluctuations and flicker in public low voltage systems, for equipment with rated current ≤ 16A per phase
EN 61000 – 6 – 2 Version 2005	Electromagnetic compatibility (EMC) – Part 6-2: Generic Standard – Immunity standard for industrial environment
EN 55024 Version 2010 + A1 - 2015	Information technology equipment – Immunity characteristics – Limits and methods of measurement

The conformity of the above given product to the European Directive 2011/65/EU with changes of 2015/863/EU (for restrictions of the use for certain hazardous substances in electrical and electronic equipment) is given by qualification of components and manufacturing process within the ISO 9001 QM system. The necessary information and declarations are documented and memorized.

The above given product was developed, manufactured and tested within an internal quality management system. This ISO 9001 QM system was approved by:

Notified body:	TÜV - CERT
Adress:	Zertifizierungsstelle des RWTÜV Steubenstrasse 53 D - 45138 Essen
No. of approval	041 004 500
Dated:	20.10.1994
Valid until:	December 2021

7.2 TÜV Certificate

NRAQ.E479848 - Programmable Controllers | UL Product iQ https://iq.ulprospector.com/en/profile?e=86751

NRAQ.E479848 - Programmable Controllers Programmable Controllers

See General Information for Programmable Controllers

KEB AUTOMATION KG
SUEDSTRASSE 38
32683 BARNTRUP, GERMANY

E479848

Investigated to ANSI/UL 508

Front-Panel Mounting Display, for use on a flat surface of a type 1 and 4X INDOOR enclosure, Model(s) aaC6AF1-44xx Where "a" may be any character for different sizes of panel display. Where ?xx? can be 02 or 05 representing SW Configuration.

aaC6AF1-45xx Where "a" may be any character for different sizes of panel display. Where ?xx? can be 02 or 05 representing SW Configuration.

Open type, Programmable controllers Model(s) 00C6CB1-0100, 00C6CB1-0200, 00C6CB1-0300, 00C6CB1-0400, 00C6CB1-0500, 00C6CB1-0600, 00C6CB1-0700, 00C6CB1-0800, 00C6CB1-0900, 00C6CB1-1000, 00C6CB1-1100, 00C6CB1-1200, 00C6CB1-1300, 00C6CB1-1400, 00C6CB1-1600, 00C6CB1-1700, 00C6CB1-1800, 00C6CB1-1900, 00C6CB1-2000, 00C6CB1-2100, 00C6CC1-0100, 00C6CC1-0200, 00C6CC1-0300, 00C6CC1-0400, 00C6CC1-0500, 00C6CC1-0700, 00C6CC1-0800, 00C6CC1-0900, 00C6CC1-1000, 00C6CC1-1100, 00C6CC1-1200, 00C6CC1-1300, 00C6CC1-1400, 00C6CC1-1500, 00C6CC1-1600, 00C6CC1-1700, 00C6CC1-1800, 00C6CC1-1900, 00C6CE1-0100, 00C6CE1-0200, 00C6CF1-0200, 00C6CH1-0100, 00C6CJ1-0100, 00C6HA1-xxxx, 00C6HB1-xxxx

Programmable Controllers Model(s) 00C6CA1-0100 where xy may be 00,02,03,04,06,07,08,09 or 10.

00C6CF1-0100 where xy may be 00,02,03,04,06,07,08,09 or 10.

Programmable controllers Model(s) aaC6HA1-xxxx Where "a" may be any character for different sizes of panel display.

aaC6HB1-xxxx Where "a" may be any character for different sizes of panel display.

Investigated to UL 61010-1 and UL 61010-2-201

Programmable Automation Controller, PAC Model(s) C6 Smart, xxC6Gxx-xxxx

Investigated to UL 61010-1, 3rd Edition and UL 61010-2-201, 1st Edition

Front-Panel Mounting or Open type Industrial PC Model(s) 00C6HM1-xxxx Where "xxxx" is a 4 digit / letter combination for different software configurations.

00C6HN1-xxxx Where "xxxx" is a 4 digit / letter combination for different software configurations.

aaC6HM1-xxxx Where "a" may be any character for different sizes of panel display. Where "xxxx" is a 4 digit / letter combination for different software configurations.

aaC6HN1-xxxx Where "a" may be any character for different sizes of panel display. Where "xxxx" is a 4 digit / letter combination for different software configurations.

Industrial PC Model(s) 00C6HL1-xxxx Where "xxxx" is a 4 digit / letter combination for different software configurations.

Industrial PC Model(s) 00C6HP1-xxxx Where "xxxx" is a 4 digit / letter combination for different software configurations.

00C6HQ1-xxxx Where "xxxx" is a 4 digit / letter combination for different software configurations.

Programmable controllers Model(s) aaC6JF1-110x Where "a" may be any character for different sizes of panel display. Where ?x? is any digit representing Customer ID.

aaC6JF1-111x Where "a" may be any character for different sizes of panel display. Where ?x? is any digit representing Customer ID.

aaC6JF1-112x Where "a" may be any character for different sizes of panel display. Where ?x? is any digit representing Customer ID.

Investigated to UL 61010-1, 3rd Edition and UL 61010-2-201, 2nd Edition

Programmable Controllers, "Multi Fieldbus Interface C6 Remote I/OS" Model(s) 00C6CH1-0200, 00C6CH1-0300, 00C6CH1-0400, 00C6CH1-0500

Investigated to

Industrial PC Model(s) 00C6HC1-xxxx

Last Updated on 2020-03-11

The appearance of a company's name or product in this database does not in itself assure that products so identified have been manufactured under UL's Follow-Up Service. Only those products bearing the UL Mark should be considered to be Certified and covered under UL's Follow-Up Service. Always look for the Mark on the product.

UL permits the reproduction of the material contained in the Online Certification Directory subject to the following conditions: 1. The Guide Information, Assemblies, Constructions, Designs, Systems, and/or Certifications (files) must be presented in their entirety and in a non-misleading manner, without any manipulation of the data (or drawings). 2. The statement "Reprinted from the Online Certifications Directory with permission from UL" must appear adjacent to the extracted material. In addition, the reprinted material must include a copyright notice in the following format: "© 2020 UL LLC"



Austria | KEB Automation GmbH

Ritzstraße 8 4614 Marchtrenk Austria
Tel: +43 7243 53586-0 Fax: +43 7243 53586-21
E-Mail: info@keb.at Internet: www.keb.at

Belgium | KEB Automation KG

Herenveld 2 9500 Geraardsbergen Belgium
Tel: +32 544 37860 Fax: +32 544 37898
E-Mail: vb.belgien@keb.de Internet: www.keb.de

Brazil | KEB South America - Regional Manager

Rua Dr. Omar Pacheco Souza Riberio, 70
CEP 13569-430 Portal do Sol, São Carlos Brazil
Tel: +55 16 31161294 E-Mail: roberto.arias@keb.de

France | Société Française KEB SASU

Z.I. de la Croix St. Nicolas 14, rue Gustave Eiffel
94510 La Queue en Brie France
Tel: +33 149620101 Fax: +33 145767495
E-Mail: info@keb.fr Internet: www.keb.fr

Germany | **Headquarters**

KEB Automation KG
Südstraße 38 32683 Barntrup Germany
Telefon +49 5263 401-0 Telefax +49 5263 401-116
Internet: www.keb.de E-Mail: info@keb.de

Germany | **Geared Motors**

KEB Antriebstechnik GmbH
Wildbacher Straße 5 08289 Schneeberg Germany
Telefon +49 3772 67-0 Telefax +49 3772 67-281
Internet: www.keb-drive.de E-Mail: info@keb-drive.de

Italia | KEB Italia S.r.l. Unipersonale

Via Newton, 2 20019 Settimo Milanese (Milano) Italia
Tel: +39 02 3353531 Fax: +39 02 33500790
E-Mail: info@keb.it Internet: www.keb.it

Japan | KEB Japan Ltd.

15 - 16, 2 - Chome, Takanawa Minato-ku
Tokyo 108 - 0074 Japan
Tel: +81 33 445-8515 Fax: +81 33 445-8215
E-Mail: info@keb.jp Internet: www.keb.jp

P.R. China | KEB Power Transmission Technology (Shanghai) Co. Ltd.

No. 435 QianPu Road Chedun Town Songjiang District
201611 Shanghai P.R. China
Tel: +86 21 37746688 Fax: +86 21 37746600
E-Mail: info@keb.cn Internet: www.keb.cn

Republic of Korea | KEB Automation KG

Room 1709, 415 Missy 2000 725 Su Seo Dong
Gangnam Gu 135- 757 Seoul Republic of Korea
Tel: +82 2 6253 6771 Fax: +82 2 6253 6770 E-Mail: vb.korea@keb.de

Russian Federation | KEB RUS Ltd.

Lesnaya str, house 30 Dzerzhinsky MO
140091 Moscow region Russian Federation
Tel: +7 495 6320217 Fax: +7 495 6320217
E-Mail: info@keb.ru Internet: www.keb.ru

Spain | KEB Automation KG

c / Mitjer, Nave 8 - Pol. Ind. LA MASIA
08798 Sant Cugat Sessgarrigues (Barcelona) Spain
Tel: +34 93 8970268 Fax: +34 93 8992035 E-Mail: vb.espana@keb.de

United Kingdom | KEB (UK) Ltd.

5 Morris Close Park Farm Industrial Estate
Wellingborough, Northants, NN8 6 XF United Kingdom
Tel: +44 1933 402220 Fax: +44 1933 400724
E-Mail: info@keb.co.uk Internet: www.keb.co.uk

United States | KEB America, Inc

5100 Valley Industrial Blvd. South
Shakopee, MN 55379 United States
Tel: +1 952 2241400 Fax: +1 952 2241499
E-Mail: info@kebameric.com Internet: www.kebameric.com

**MORE KEB PARTNERS WORLDWIDE:**www.keb.de/company/representatives-agencies



Automation with Drive

www.keb.de

KEB Automation KG Suedstrasse 38 32683 Barntrup Germany Tel. +49 5263 401-0 E-Mail: info@keb.de