

DATENBLATT / DATA SHEET	Seite 1 von 2
Sinusfilter 30.Z1.G04-1004	Rev. B



ALLGEMEINE BESCHREIBUNG / GENERAL DESCRIPTION

Filtertyp	<i>type of filter</i>	Sinusfilter / sine wave filter
Leiteranzahl	<i>number of phases</i>	3 ph + PE / Ground
Anschlussquerschnitt / Kemme	<i>conductor cross section / terminal</i>	2 x M12 (185mm ²)
Anschluss PE	<i>conductor connection PE</i>	M16
Approbation	<i>approbation</i>	CE

ELEKTRISCHE DATEN AUSGANGS - FILTER / ELECTRICAL DATA OUTPUT - FILTER

Bemessungsspannung <i>nominal voltage U_N</i>	[V _{AC}]	3 x 400 (max. 530)
Bemessungs - Nennstrom <i>nominal current (I_N at t_{max})</i>	[A]	570
maximal Strom <i>maximum current ($t_{max} \leq 30sec$)</i>	[A]	713
maximale Motor-Frequenz <i>maximum motor-frequency</i>	[Hz]	1200
Umrichter Schaltfrequenz <i>inverter switching frequency</i>	[kHz]	12
maximale Umgebungstemperatur <i>maximum ambient temperature t_{max}</i>	[°C]	45
Spannungsabfall bei I_N <i>voltage loss at I_N, 1200Hz</i>	[%]	20
DC-Widerstand <i>DC-resistance</i>	[μΩ]	60
Verlustleistung bei I_N , f_N <i>power dissipation at I_N, f_N</i>	[W]	1200
Schutzklasse <i>protection class</i>		IP20
Klimakategorie <i>categorie for climate (as EN60721-3-3)</i>		3K3

Erstellt:	Breitenbach	Geprüft:	Erasmie	Freigegeben:	
Datum:	10.08.2011	Datum:	10.08.2011	Datum:	

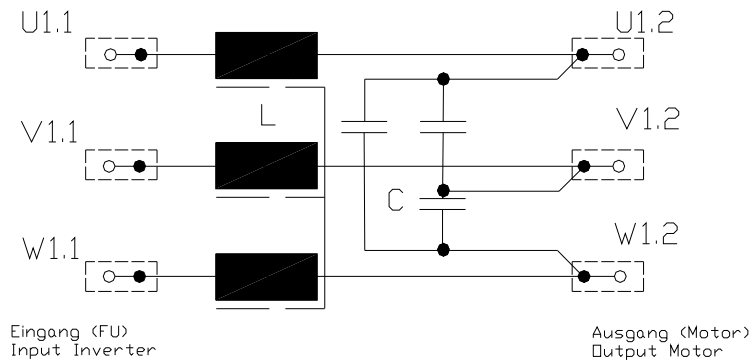
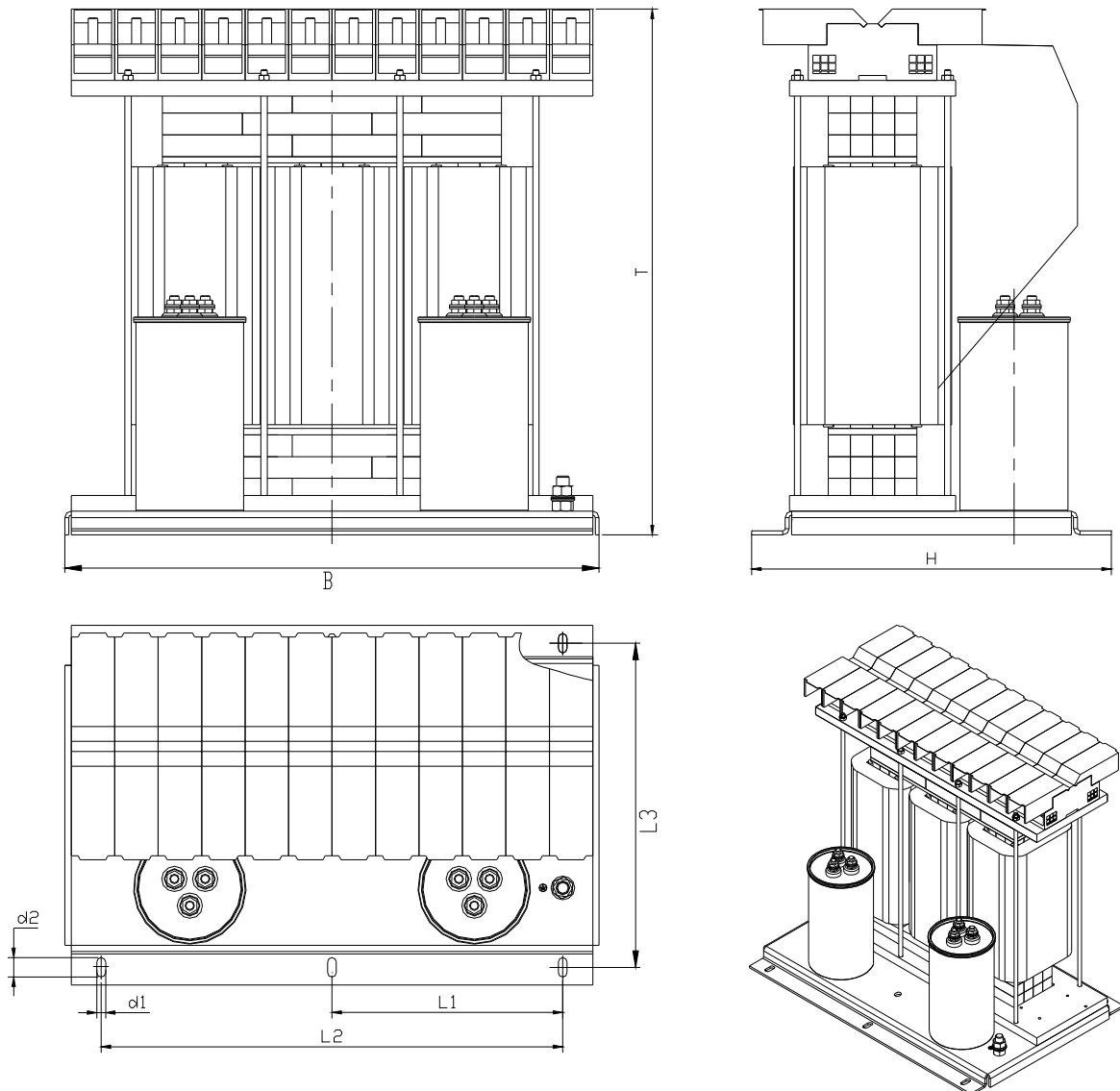
SCHALTBILD / CIRCUIT DIAGRAM**MECHANISCHER AUFBAU / MECHANICAL OUTLINE**

Maß B in mm	Maß H in mm	Maß T in mm	Maß L1 in mm	Maß L2 in mm	Maß L3 in mm	Maß d1 in mm	Maß d2 in mm	Gewicht in kg	CU in kg
676	455	665	584	292	410	11	24,5	108	29