

DATENBLATT / DATA SHEET	Seite 1 von 2
Sinusfilter 29Z1G04-1000	Rev. D



ALLGEMEINE BESCHREIBUNG / GENERAL DESCRIPTION

Filtertyp	<i>type of filter</i>	Sinusfilter / sine wave filter
Leiteranzahl	<i>number of phases</i>	3 Ph. + PE / Ground
Anschlussquerschnitt / Klemme Drehmoment	<i>conductor cross section / terminal torque</i>	M16 (300mm ²) 25 - 60 Nm / 221 - 531 lb/inch
Anschlussquerschnitt PE Anzugmoment	<i>conductor cross section PE torque</i>	M12 56 Nm / 495,6 lb-inch
Approbation	<i>approvals</i>	CE, cURus (UL-file: E312146)

ELEKTRISCHE DATEN AUSGANGS - FILTER / ELECTRICAL DATA OUTPUT - FILTER

Bemessungsspannung <i>nominal voltage</i>	[V _{AC}]	3 x 400 (max. 500)
Bemessungsstrom / Nennstrom <i>nominal current I_N (at T_{max})</i>	[A]	460
Max. Strom <i>max. current (T_{max} ≤ 30sec)</i>	[A]	575
Max. Motor-Frequenz <i>max. motor-frequency</i>	[Hz]	87
Umrichter Schaltfrequenz <i>inverter switching frequency</i>	[kHz]	2 - 16
Max. Umgebungstemperaturen <i>max. ambient temperatures</i>	[°C]	-10...45
Spannungsabfall bei I _N <i>voltage loss at I_N, 50Hz</i>	[%]	12
DC-Widerstand <i>DC-resistance</i>	[mΩ]	0,6
Verlustleistung <i>power dissipation (at I_N, f_N)</i>	[W]	630
Schutzklasse <i>protection class</i>		IP20
Klimakategorie <i>Category for climate (as EN60721-3-3)</i>		3K3

Erstellt:	Breitenbach	Geprüft:	Erasmie	Freigegeben:	Erasmie
Datum:	19.01.2015	Datum:	19.01.2015	Datum:	19.12.2008

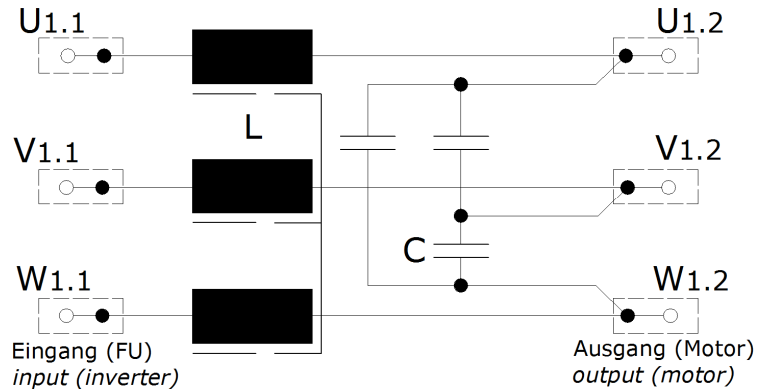
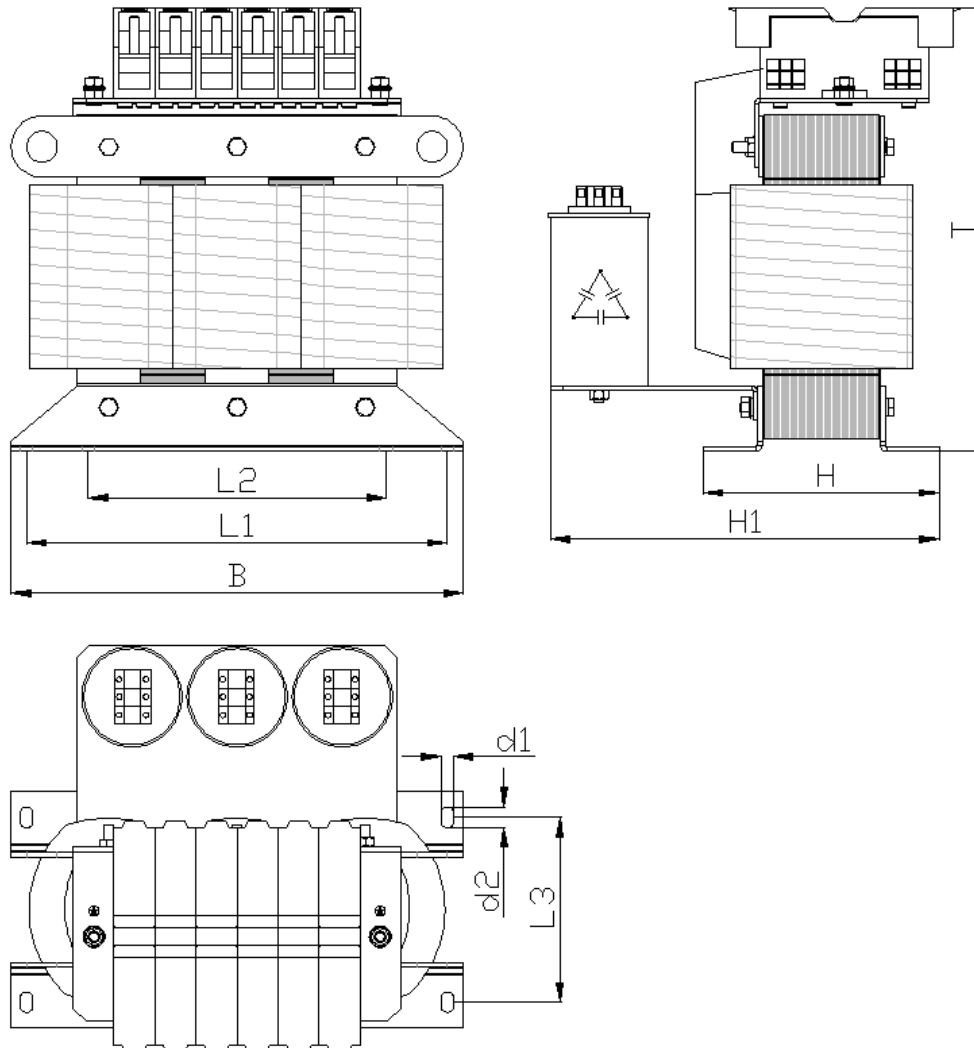
SCHALTBILD / CIRCUIT DIAGRAM**MECHANISCHER AUFBAU / MECHANICAL OUTLINE**

Maß B in mm	Maß H in mm	Maß H1 in mm	Maß T in mm	Maß L1 in mm	Maß L2 in mm	Maß L3 in mm	Maß d1 in mm	Maß d2 in mm	Gewicht in kg	CU in kg
552	319	600	545	516	356	262	14,5	24	275	80