



COMBIVERT H6

MULTI AXIS DRIVE SYSTEM

EN



CONTENT	PAGE
System overview	3
Benefits	4
COMBIVERT H6 System	6
Functional Safety	8
H6 axis modules	10
H6 control module with 24 power supply	12
H6 rectifier modules	13
H6 Active Front End modules (AFC)	14
Accessories	16
Servo gear motors	18
Servo motors - TA	19
COMBIVIS 6	20
KEB service	22
KEB worldwide	23

SYSTEM OVERVIEW

Automation with Drive

stands as a synonym for optimally selected combinations of control and automation solution. With the drive level at the end it is the key to successful machine concepts.

Let the following pages inspire you with regards to the diversity and performance of the multi-axis drive system COMBIVERT H6 and help you to find a solution that reliably meets your requirements.

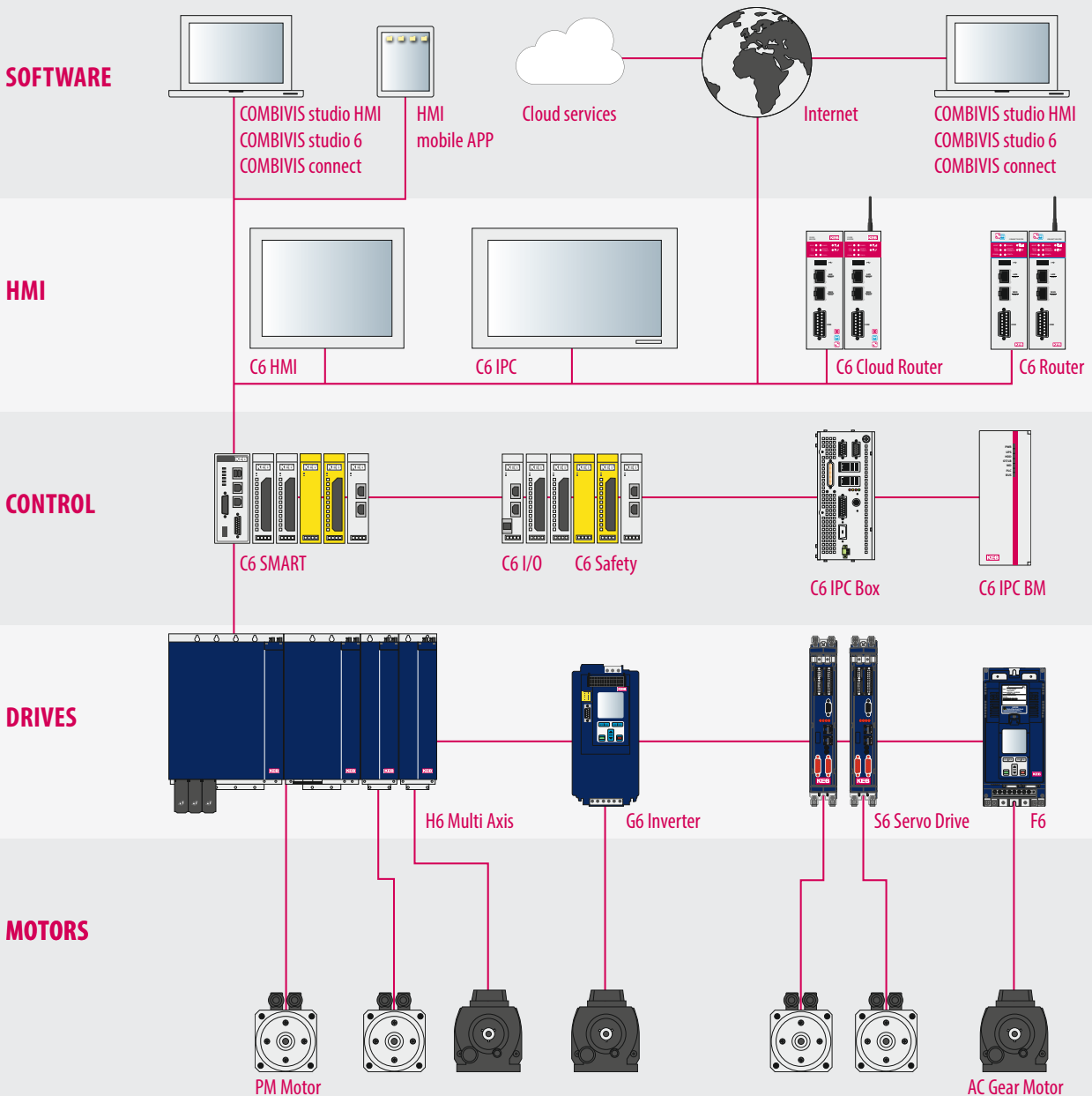

COMBIVERT H6 BENEFITS

From more than 30 years of experience with electronic drive technology, sophisticated control algorithms for all common motor versions have been developed. Based on our extensive experience on single inverter and servo drives, we are now pleased to offer the COMBIVERT H6, the complete drive solution for machine automation.

COMBIVERT H6 has integrated all the experiences in one device with control and communication technology, perfect adaptable to machine builder requirements.

THE MODULAR DRIVE TECHNOLOGY: COMBIVERT H6

COMBIVERT H6 is the product family for multi-axis solutions



HIGHLIGHTS

- Space-saving design of a multi-axis drive system
- Load share via protected DC bus link
- Significantly reduced wiring and installation
- Integrated Soft-PLC-, Motion- and NC- control
- Integrated 24 V DC supply
- Standardized connection technology simplifies handling
- Integrated two-level safety systems
- Innovative central cooling solutions for heat dissipation outside the control cabinet
- Improved quality and lifetime by means of active DC-bus capacitor cooling
- Central operation concept for the complete system
- Standardized programming tools with diagnostics

DRIVE BASED SAFETY

- Integrated Safety functionality
- STO and SBC as standard
- Speed dependent safety functions as an option

REAL-TIME COMMUNICATION

- EtherCAT as real-time Ethernet-based interfaces
- Other Ethernet - based interfaces in the control unit
- RS232/485 for diagnostics or display

ALL IN ONE - UNIVERSAL MOTOR OPERATIONS

- Control for synchronous or asynchronous - V/f made for asynchronous motors
- Motor operation with encoder feedback or encoderless ASCL/SCL for precise speed control
- Motor temperature monitoring with PTC, KTY or PT1000 sensors
- Two-channel multi-encoder interface
- Integrated GTR7 brake transistor in the supply unit
- Integrated brake control and brake supply



HIGHLIGHTS

- Uncompromising integration, highest performance
- Modern realtime communication standards
- Integrated functional safety
- Particular compact size
- Modular design, flexible cooling systems
- Reduces number of system components

COMBIVERT H6 SYSTEM

MODULAR AND FLEXIBLE

The COMBIVERT H6 Multi-axis system is a DC intermediate circuit coupled drive controller system for the operation of synchronous and asynchronous machines.

The wide performance range covered by the system and the multiple combination options enable flexible use of the H6 System in a broad spectrum of different applications up to 315A. The H6 system bus is EtherCAT.

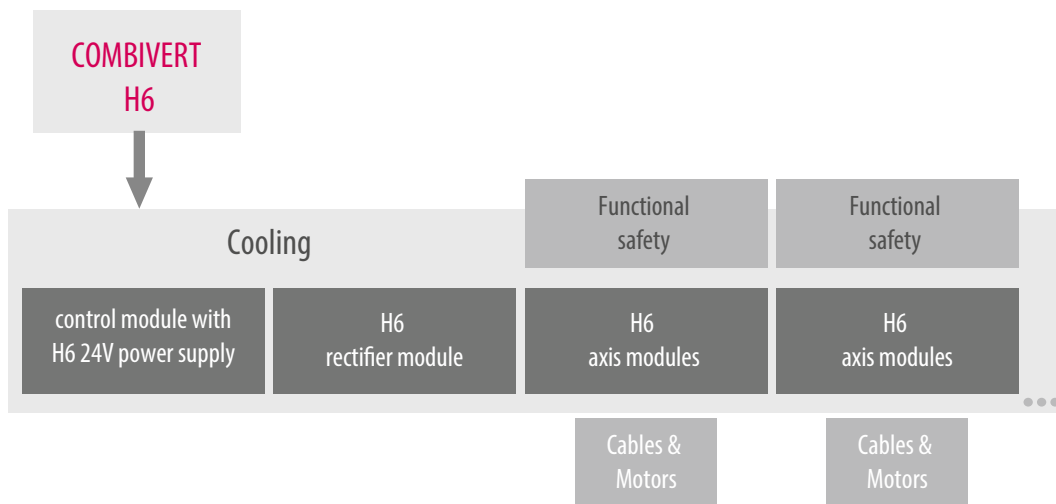

HIGHLIGHTS

- Space-saving fitting of a DC intermediate circuit coupled drive system
- Very high output density
- Reduced wiring costs and time-saving assembly due to system design concept (e.g. with DC power and 24V DC rail system).
- Coverage of a wide current range (axis module $I_n = 2.6A$ to 210A and up to 2.2 times overload)
- Problem-free coupling with other KEB Drives (e.g. Type F6)
- Energy-saving due to storage and regeneration capability (AFE)
- Enables optimum utilization of the motor by boost converter function (AFE)
- Regulation of synchronous and asynchronous machines, regulated with or without encoder (SCL and ASCL)

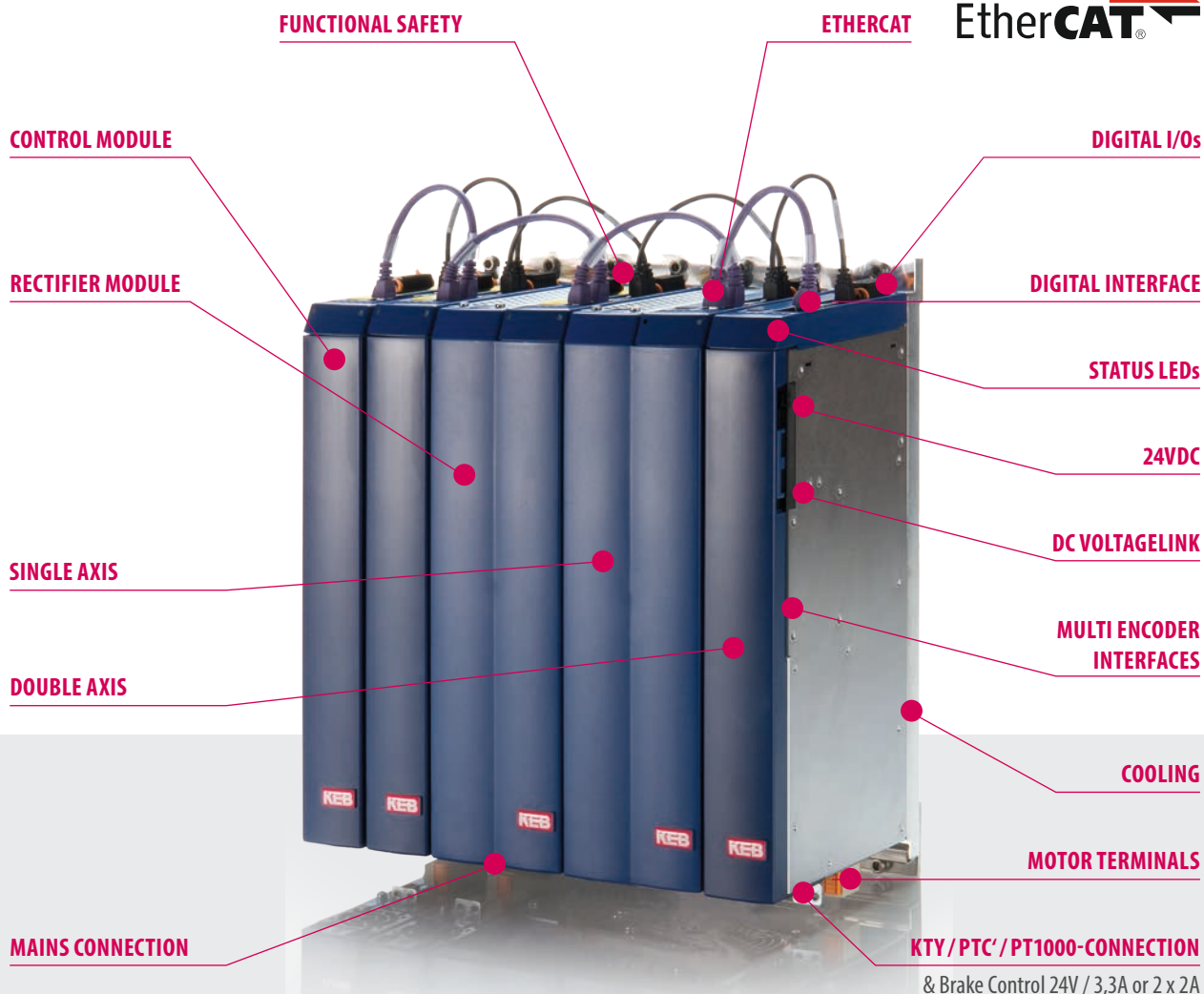

HIGHLIGHTS

- Reduces number of system components
- 4 models: 50 mm, 100 mm, 200 mm and 300 mm
- Range of cooling options
- Flexible automation system
- Integrated Motion Controller
- COMBIVIS 6 operating software for commissioning and diagnostics for drives, controls and safety
- Certified integrated safety functions to PLe: STO, SBC, SLS, SDI, SLP, etc.
- UL / UR acceptance



EC Type-Examination Certificate



Reg.-Nr./No.: 01/205/5517.00/16

Prüfgegenstand Product tested	Sicherheitsfunktion STO auf der Steuerkarte des COMBIVERT F6-K Umrichter Safety function STO on control board within the COMBIVERT F6-K inverter	Zertifizierer Certificate holder	KEB Karl E. Birkmann GmbH Friedenweg 36-38 32083 Barntrop Germany
Typbezeichnung Type designation	Steuerkarte / Control board SKF6-K0-010, SKF6-K0-011 zur Verwendung in den Umrichtern / to be used in inverters auf SK6xxx		
Prüfgrundlagen Codes and standards	EN 61800-5-2:2007 EN 61800-5-4:2007 EN 60951:2005 + AC:2010 + A1:2013 + A2:2015	EN ISO 13849-1:2015 EN 60554-1:2004 + A1:2006 + AC:2010 (in-schluss) IEC 61508 Parts 1-7:2010	
Bestimmungsbereich Intended application	Die Sicherheitsfunktion "Safe Torque Off" (STO) erfüllt die Anforderungen der Prüfgrundlagen (Cat. 4 / PL 4) nach EN ISO 13849-1, SIL 3 / SIL CL 3 nach EN 61800-5-2 / EN 60951 / IEC 61508 und kann für Anwendungen bis zu dieser Sicherheitsstufe eingesetzt werden. The safety function "Safe Torque Off" (STO) complies with the requirements of the relevant standards (Cat. 4, PL 4) in acc. to EN ISO 13849-1, SIL 3 / SIL CL 3 acc. to EN 61800-5-2 / EN 60951 / IEC 61508 and can be used in applications up to these safety levels.		
Besondere Bedingungen Specific requirements	Die Hinweise in der zugehörigen Installations- und Betriebsanleitung sind zu beachten. The instructions of the associated installation and Operating Manual shall be considered. Es wird bestätigt, dass der Prüfgegenstand mit den Anforderungen nach Anhang I der Richtlinie 2006/42/EG über Maschinen übereinstimmt. It is confirmed that the product under test complies with the requirements for machines defined in Annex I of the EC Directive 2006/42/EC.		
Gültig bis / Valid until 2021-06-01			
Der Ausstellung dieses Zertifikates liegt eine Prüfung zugrunde, deren Ergebnisse im Bericht Nr. 968/M 303.01/16 vom 01.06.2016 dokumentiert sind. Dieses Zertifikat ist nur gültig für Erzeugnisse, die mit dem Prüfgegenstand übereinstimmen. Es wird ungültig bei jeglicher Änderung der Prüfgrundlagen für den angegebenen Verwendungszweck. The issue of this certificate is based upon an examination, whose results are documented in Report No. 968/M 303.01/16 dated 01.06.2016. This certificate is valid only for products which are identical with the product tested. It becomes invalid at any change of the codes and standards forming the basis of the certificate for its intended application.			
Berlin, 2016-06-01			
www.fs-products.com www.buv.com		 TÜVRheinland® Precisely Right.	

© 2016 TÜV Rheinland AG, Köln. Alle Rechte vorbehalten. Fotodruck. Bildbearbeitung: www.tuev.com



HIGHLIGHTS

- possible download of encrypted data packets through machine controllers modular safety concept
- dual channel ripple interface for cascading functional safety over multiple KEB drives
- dual OSSD outputs for supply of the safe digital inputs (detection of wire break, shortcut and external supply)
- safe parameterization through COMBIVIS 6 with protected operation levels

FUNCTIONAL SAFETY

SAFETY FUNCTIONS ACCORDING TO IEC 61508 - SIL3, ISO 13849 - PL e

With the drive-based-safety, safety functions are shifted into the drive platform and the costs of separate protective devices are reduced. The drive controllers COMBIVERT H6 are prepared for the different requirements in their modular structure.

The H6 can be equipped with different safety modules. Depending on the requirement, basic functions with the Module 1 and a wide range of functions are available with the Module 2, which are addressed via safe inputs and outputs and safe FSoE communication.

The full Safety System results in the interaction of the drive controllers with the C6 Safety PLC and the C6 Safety I / O's.

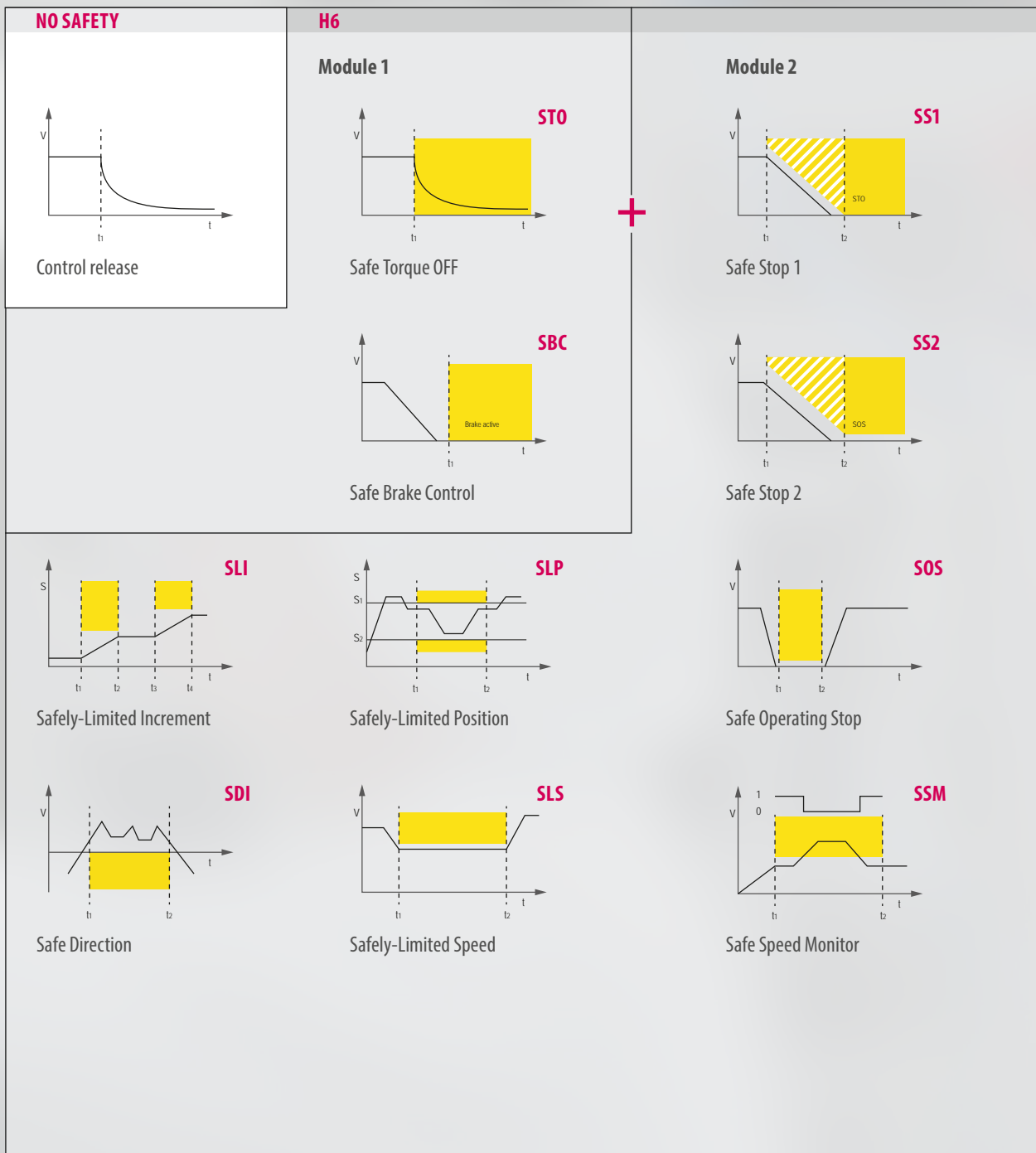

H6 AXIS MODULES

AXIS MODULES	size	07	10	12	13	14	15	16
Version		Single axis modules						
Rated apparent output power S_n	[kVA]	1.8	4	6.2	8.3	11	17	23
Rated active power P_n	[kW]	0.75	2.2	4	5.5	7.5	11	15
Rated input voltage U_n	[V]							
Rated input current I_n	[A]	2.6	5.8	9	12	16.5	24	33
Maximum current I_{max}	[A]	5.2	11.6	18	24	33	43.2	59
OC-tripping current I_{OC}	[A]	6.2	13.9	21.6	28.8	39.6	51.8	71
Switching frequency $f_{s_{nenn/max}}$	[kHz]							
OH level temperature	[°C]	80	80	80	80	80	80	80
Power loss at nom. operation at heat sink P_{Dext}	[W]	18	37	58	77	99	150	209
Power loss at nom. operation inside P_{Dint}	[W]	18	22	26	31	39	47	61
Module width	[mm]	50	50	50	100	100	100	100
Air cooled housing		■	■	■	■	■	■	■
Flat rear housing		■	■	■	■	■	■	■



HIGHLIGHTS

- Wide power range - rated currents from 2.6A to 210A
- Very high power density
- Different types of cooling
- Integrated brake output 24V DC / 3.3A (single-axis module) or 2x 2A (double-axis module)
- Certified integrated safety functions to PL e: STO and SBC as standard
- Speed-dependent safety functions to PLe, also SLS, SDI, SLP, etc. as optional
- EtherCAT system bus
- Control by means of drive profile according to CiA402
- Regulation of synchronous - and asynchronous machines, with and without encoder feedback
- Ideally suited for KEB brand motors as well as non-KEB motors
- 2-channel multi-encoder – interface for evaluation of incremental encoder, resolver, Sin/Cos, EnDat, Hiperface, BiSS, SSI, etc.
- Real field-orientated regulation without encoder feedback for synchronous - and asynchronous machines (SCL / ASCL), as well as V/f operation
- Further increase in proven KEB shaft performance
- Optimization of motor operation properties with functions such as anti-cogging, torque pre-control of linear and non-linear kinematics, etc.
- UL / UR acceptance

18	19	20	21	22	23	24	25	07	10	12
__ H6A __								Double axis modules __ H6B __		
33	42	52	62	76	100	125	145	2 x 1.8	2 x 4	2 x 6.2
22	30	37	45	55	75	90	110	2 x 0.75	2 x 2.2	2 x 4
400										
48	60	75	90	110	145	180	210	2 x 2.6	2 x 5.8	2 x 9
86	90	135	162	198	218	270	315	2 x 5.2	2 x 11.6	2 x 18
103	108	162	194	238	261	324	378	2 x 6.2	2 x 13.9	2 x 21.6
4/8 (with derating)								4		
80	80	80	80	80	80	80	80	80	80	80
316	382	522	641	802	1,117	1,341	1,656	36	74	116
72	79	85	89	119	165	149	165	26	34	42
100	100	200	200	200	200	300	300	50	50	50
■	■	■	■	■	-	■	-	■	■	■
■	■	■	■	■	■	■	■	■	■	■

MECHANICAL DATA, OPERATING TYPES, STANDARDS

OPERATING MODES

Motor control mode	PMSM: field-oriented with encoder, S.C.L. encoderless. ASM: V/F, field-oriented with encoder, A.S.C.L. encoderless.
Application profile	CiA 402
Control mode	Asynchronous speed specification (Velocity Mode) Cycl. Synchronous speed specification (Cycl. Sync. Velocity Mode) Cycl. Synchronous position specification (Cycl. Sync. Position Mode) Single-axis positioning module (Profile Positioning Mode) Homing Mode Torque pilot control crank drives

GENERAL

Product standard	EN 61800-2, -5-1
Protection class	IP 20 / VBG 4
Environment	EN 60721-3-3 Operating temperature -10 ... 45 °C Storage temperature -25 ... 70 °C Humidity 3K3 - 5 ... 85% (no condensation)
Site altitude	Rated to 1000 m (1% derate per 100m above 1000m) max. 2000m above sea level.

H6 CONTROL MODULES WITH 24V POWER SUPPLY

CONTROL MODULES WITH 24V POWER SUPPLY

The 50 mm H6 control module with 24 power supply is the highly efficient solution for PLC, Motion Control and integrated 24 V DC supply - containing a 24 V power supply and an embedded control, guarantees a further size reduction of the control cabinet.

H6 CONTROL MODULE WITH 24 POWER SUPPLY

24 V power supply/IEC control with EtherCAT Master 0_H6GDB/P __

Floating Point Unit		■
Internal Memory		256 MB
Systembus EtherCAT, 2 x RJ45	[MB]	10/100
Diagnostic interface , D-Sub 9		RS 232/485
Power supply Un	[V _{DC}]	24
Digital IN		4
Digital OUT		4
Field Bus slave optional		Profibus, Interbus, CAN, ProfiNet, Powerlink, EtherCAT
Module size W x H x D	[mm]	50 x 407 x 198 / 295*
Air cooled housing*		■
Flat rear housing		■

24V POWER SUPPLY MODULE

24 V power supply 01.H6.GBB/P __

Rated apparent output power S_n	[VA]	600
Rated active power P_n	[W]	500
Nominal input voltage	[V _{AC}]	320 ... 480
Rated output current I_n	[A _{DC}]	25 (UL : 20A)
Maximum current I_{max}	[A _{DC}]	40
Power loss at nom. operation P_L	[W]	65
Module size W x H x D	[mm]	50 x 407 x 198 / 295*
Air cooled housing *		■
Flat rear housing		■

RECTIFIER MODULES	SIZE	19	20	21	24	25	27	28
Type		B6 bridge rectifier __H6C__						
Rated apparent output power S_n	[kVA]	31	39.5	51	104	131	170	242
Rated active power P_n	[kW]	30	37	48	95	120	155	225
Rated input voltage U_n	[V]	400						
Rated input current I_n	[A _{AC}]	45	57	74	150	190	245	350
Base load current I_H	[A _{AC}]	37	47	61	123	155	201	287
Current in S6 mode $I_{S6_40\%/10min.}$	[A _{AC}]	58	74	96	195	246	319	455
Maximum current I_{max}	[A _{AC}]	81	103	133	270	341	441	630
OC-tripping current I_{OC}	[ADC]	97	123	160	324	410	529	756
Rated output current I_{DCn}	[A _{DC}]	55	70	90	180	230	300	435
OH level temperature	[°C]	80	80	60	80	60	80	60
Power loss at nom. operation at heat sink P_{Dext}	[W]	175	250	320	375	450	650	950
Power loss at nom. operation inside P_{Dint}	[W]	60	75	85	60	70	85	1100
Module width	[mm]	100	100	100	300	300	300	300
Air cooled housing		■	■	■	■	■	■	-
Flat rear housing		■	■	■	■	■	■	■

Technical data for 2/4-pole motors; other number of poles or special motors: adapt supply module for DC-current. Mains choke with $u_k = 4\%$ assumed.



HIGHLIGHTS

- Scalable performance for the H6 multi-axis system supply
- Large output range up to 225 kW rated output
- Input voltage range 305 to 528VAC at 50/60Hz
- Suitable network types: TN, TT, IT
- Wide range of radio interference filters and power chokes available for use
- Different Types of cooling
- Integrated brake transistor (GTR7)
- UL / UR Acceptance

ACTIVE FRONT END MODULES (AFC)

ACTIVE FRONT END MODULES (AFC)	SIZE	14	19	21	24	26
Type		AFE-sinusoidal power supply / regeneration system __H6D__				
Rated apparent output power S_n	[kVA]	11	42	62	125	173
Rated active power P_n	[kW]	7.5	30	45	90	132
Rated input voltage U_n	[V]	400				
Rated input current I_n	[A _{AC}]	16,5	60	90	180	250
Maximum current I_{max}	[A _{AC}]	33	108	162	270	378
OC-tripping current I_{oc}	[A _{DC}]	39	173	259	378	518
Rated switching frequency f_s	[kHz]	8	8	8	8	4
OH level temperature	[°C]	80	80	80	80	80
Power loss at nom. operation at heat sink P_{Dext}	[W]	181	698	1.090	2.315	1.979
Power loss at nom. operation inside P_{Dint}	[W]	53	95	131	218	189
Module width	mm	100	200	200	300	300
Air cooled housing		■	■	■	-	-
Flat rear housing		■	■	■	■	■

CHARGING MODULES

The precharging unit operates in combination with the supply and regenerative unit AFE for sinusoidal regen operation and contains the GTR7 brake transistor for the peak load transfer to external resistors.

CHARGING MODULES	part number	00H6FAB/P-1100
Rated input voltage U_n	[V]	400
Module size W x H x D	[mm]	50 x 407 x 198 / 295*
Max. braking power with c.d.f. ED 40 %	[kW]	33
Max. braking current $I_{max_{oc}}$	[ADC]	146
Max. braking resistor	[Ohm]	6
Air cooled housing*		■
Flat rear housing		■



HIGHLIGHTS

- Supply and regeneration as AFE - Active Front End with compatible charging module and AFE filter
- Sinusoidal energy intake and recover of optimum quality THD(i) < 3.5 %
- Regulated DC intermediate circuit for the same regulation performance even with variable major fluctuations in network conditions
- Adjustable DC-DC intermediate circuit voltage enables optimized drive design (boost converter function)
- Wide output range up to 173kVA rated output
- Different Types of cooling
- Integrated brake transistor (GTR7) in charging module

AFE FILTER

In applications with high or continuous regenerative power, the energy provider requires a low ratio of harmonics (THD value) at the power supply unit.

The AFE-supply / regenerative moduls of the COMBIVERT H6 system have to be used with proper designed AFE-filters for sinusoidal regeneration operation. Depending on the application, these filters are designed for 100 % or 60 % regenerative duty cycle.

Accessories	AFE FILTER	I_N 100 %	W	H	D	m
AFE supply unit	part number	[A]	[mm]	[mm]	[mm]	[kg]
14H6Dxx-xxxx	14H6J4E-1000	16,5	200	470	214	16.0
19H6Dxx-xxxx	19H6J4F-1000	60	250	570	214	34.0
21H6Dxx-xxxx	21H6J4F-1001	90	250	570	214	42.5
24H6Dxx-xxxx	24H6J4G-1000	180	300	750	271	68.0

Accessories	AFE FILTER	I_N 60 %	W	H	D	m
AFE supply unit	part number	[A]	[mm]	[mm]	[mm]	[kg]
19H6Dxx-xxxx	19H6J4E-1000	36	200	470	214	21.5
21H6Dxx-xxxx	21H6J4F-1000	54	250	570	214	32.0
24H6Dxx-xxxx	24H6J4F-1000	108	250	570	214	41.0
26H6Dxx-xxxx	26H6J4G-1000	250	300	750	271	68.0

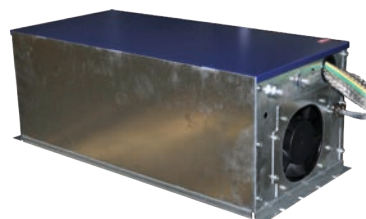
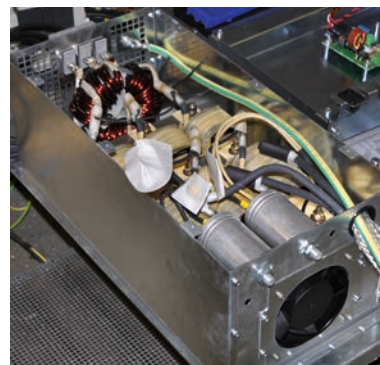

DC CONNECTION MODULE AND DC-TERMINAL

H6 DC-connection devices extend the range of applications of an H6 system. They enable the internal DC high-voltage intermediate circuit to be connected to external components. E.g. if the H6 system is to be supplied via an external stand alone drive unit (e.g. KEB COMBIVERT F6) or if additional external drive units (e.g. KEB COMBIVERT S6) are to be connected to the H6 network. Furthermore a simple link can be established between two H6 systems if the package cannot be installed completely in a single row in a control cabinet panel, due to larger amount of axis.

DC-Connection Module		00H6M1B/P-100
Rated Current	[A]	150
24V-Terminal (optional)		■
Width of Module	[mm]	50
DC- Connection Module with internal DC-Fuses		20H6M1B/P-_100
Rated Current	[A]	75
24V-Terminal (optional)		■
Width of Module	[mm]	50
DC-Terminal		00H6M10-1100
Rated Current	[A]	170 / 250

ACCESSORIES

STABLE OPERATION IN INDUSTRIAL ENVIRONMENT

An EMC-compliant assembly with efficient control cabinet and suppression system is the basis for safe operation of machinery and equipment. The current and voltage limiting COMBILINE modules are optimally designed to meet the requirements of the COMBIVERT H6 multi axis drive controller series and support the use through:



MAINS EMC FILTERS

Compliance with the international standards for industrial and residential areas requires the use of EMC filters. In the COMBIVERT H6 modular system, they are installed centrally, above of the supply unit. The sizing of the modules according to EN 61800-3 environment C1 and C2 are typically based on 4 drive axes with a total motor cable length of 300 m.

LINE FILTER	I_n	I_{lk50}	I_{lkmax}	P_d	B	H	T	m
Part number	[A]	[mA]	[mA]	[W]	[mm]	[mm]	[mm]	[kg]
14E6T60-3000	22	< 3	12	14	55	252	92	1.3
16E6T60-3000	43	< 3	31	18	65	252	106	1.8
18E6T60-3000	65	< 3	24	27	130	240	142	3.9
20E6T60-3000	100	< 3	81	54	160	240	142	5.0
22E6T60-3000	150	< 3	52	80	200	321	190	9.0
24E6T60-3000	200	< 3	117	100	200	321	190	9.2
27E6T60-3000	330	< 3.5	123	160	250	516	194	22.5
28E4T60-1001	410	< 3	220	50	260	340	115	18.5

MAINS CHOKES

The COMBIVERT H6 uses a single choke from our standard Z1B04 range on the input. This will give a $u_k = 4\%$. Size selection is related to the average input current and peak load characteristic of the multi axis system.

MAINS CHOKE	I_n	I_{max}	L	B	H	T	m
Part number	[A]	[A]	[mH]	[mm]	[mm]	[mm]	[kg]
14Z1B04-1000	17.3	29.7	1.7	148	77	145	2.8
15Z1B04-1000	25.2	36	1.16	178	87	180	4.4
16Z1B04-1000	34.7	52.1	0.847	178	100	178	5.9
17Z1B04-1000	44.1	66.2	0.667	219	115	215	8.4
18Z1B04-1000	52.5	78.8	0.560	219	120	220	10
19Z1B04-1000	63	94.5	0.467	219	135	220	12
20Z1B04-1000	79	118.5	0.372	219	150	220	12
21.Z1B04-1000	95	142.5	0.310	267	155	207	15.6
24Z1B04-1000	189	283.5	0.156	316	225	235	24.8
25Z1B04-1000	221	331.5	0.133	316	225	235	25
27Z1B04-1000	315	472.5	0.093	352	230	265	34
28Z1B04-1000	390	585	0.075	388	245	295	41.5



BRAKING RESISTOR

Braking resistors can be connected to the series terminals of the GTR7 brake transistor, and ensure that energy peaks are absorbed and discharged. The compact design require only small space and they are intrinsically safe; without additional temperature sensors.

To protect against overheating and fire hazards, the brake resistors feature thermal monitoring which can be integrated into the external circuit.

THE FURTHER OPTIONS ARE

Output chokes

reduce the voltage and current stress of the motor winding.

Sine-wave filters

protect the motor winding from voltage peaks and allow the use of long motor cables.

Harmonic filters

reduce the low frequency mains distortion of B6-rectifier supplied devices. These harmonic filters are the new innovative solution to comply to most international standards. The integration to a switch gear layout is as simple as of mains chokes.

Sine-wave EMC filters

allow operation of motors with long motor cables even without screening.

High performance ferrite cores

reduces the values of du/dt 's also in the frequency range of the bearing currents.

SERVO GEAR MOTORS

INTEGRAL SERVO DESIGN

Based on the industrial standard with AC motors the portfolio of COMBIGEAR series offers a full basket of servo gear solutions. The dynamic and efficient TA servo motors are direct connected in the first gear stage - best choice for minimum lengths, nearly zero wear and small inertia of the gear motor system.

Flexible designs for flange-, foot- or combined flange/foot- mounting and a wide range of options secure individual needs in the machine. Ultra-fine speed ratio range, adjustable down to speed 0, enables optimum adaptation of torque and speed on output. Life-time lubrication, high overload and low torsional backlash ensure a long service life.

TYPE	SIZE	DESIGN	T_N [Nm]	I	TA2	TA3	TA4	TA5
G	0 ... 7	Helical gear	60 ... 4880	3.37 ... 250.97	■	■	■	■
F	2 ... 7	Shaft mounted helical gear	245 ... 4880	3.20 ... 274.23	■	■	■	■
K	0 ... 7	Helical bevel gear	58 ... 4880	3.38 ... 183.21	■	■	■	■
S	0 ... 4	Helical worm gear	55 ... 1160	5.09 ... 247.58	■	■	■	■

HELICAL GEAR

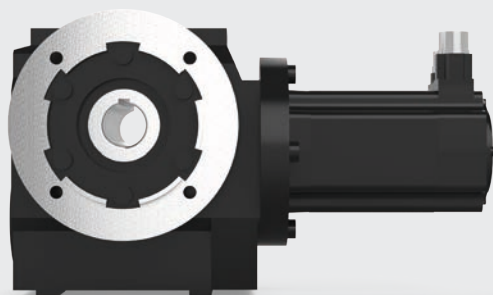

HELICAL WORM GEAR

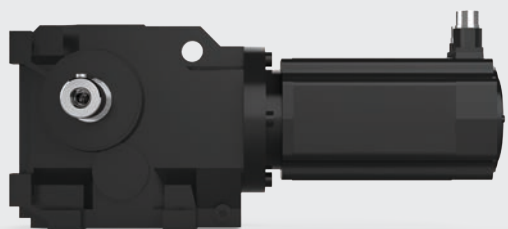

HELICAL BEVEL GEAR

SHAFT MOUNTED HELICAL GEAR

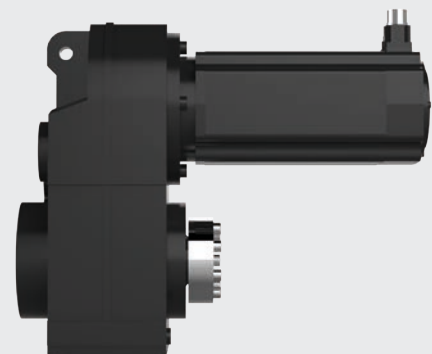

TA SERIES

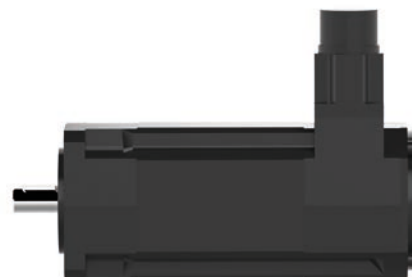
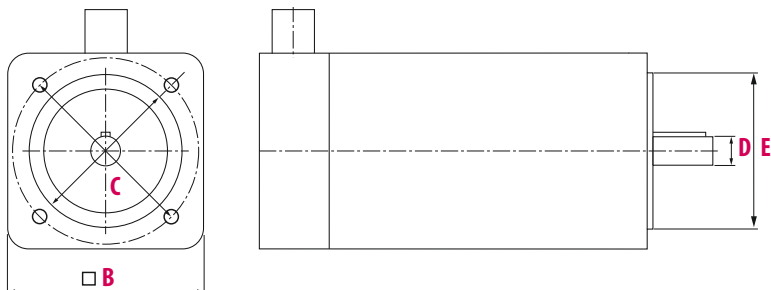

TA 2	0.82 ... 1.45				
TA 3		1.5 ... 3.9			
TA 4			6.9 ... 11.7		
TA 5				11.5 ... 20.0	Stall torque in Nm

MOTOR	T_0 [Nm]	T_N [Nm]	I_{D0} [A]	I_N [A]	N_N [rpm]	B □ [mm]	C ∅ [mm]	D ∅ [mm]	E ∅ [mm]	BRAKE OPTION T_N [Nm]
TA21	0.82	0.85	0.9	0.87	4500	75	75	11	60	2.0
TA22	1.45	1.55	1.52	1.42						
TA31	1.5	1.4	1.1	1.1	3000	88	100	14	80	4.5
TA32	2.8	2.6	1.8	1.7						
TA33	3.9	3.6	2.5	2.4						
TA41	6.9	6.3	4.0	4.1	3000	116	115	19	95	9
TA42	9.2	8.2	5.9	5.2						
TA43	11.7	10.1	7.3	6.3						
TA51	11.5	10.4	7.4	6.6	2000	145	165	24	130	18
TA52	16.1	13.5	10.3	8.7						
TA53	20.0	16.1	12.8	10.3						



HIGHLIGHTS

- 0.82 ... 20 Nm in four frame sizes
- Low inertia - high impulse torque
- Easy plug connection, straight or angled (360° rotatable)
- Compact size - directly integrated in the gear modules
- High total efficiency, lifetime lubricated, universal installation positions and robust mechanics
- Resolver or absolute rotary encoder, BiSS single and multi-turn
- Optionally with COMBIPERM holding brake

COMBIVIS 6 - THE TOOL FOR ALL TASKS

COMBIVIS 6

- Free and easy-to-use software for startup, administration and analysis
- Integrated start-up assistants (Wizards) for quick and easy configuration
- Direct access to device documentation
- 16 channel oscilloscope for extensive analysis
- Online parameter list comparison
- Parameterisation of key safety indicators and functions

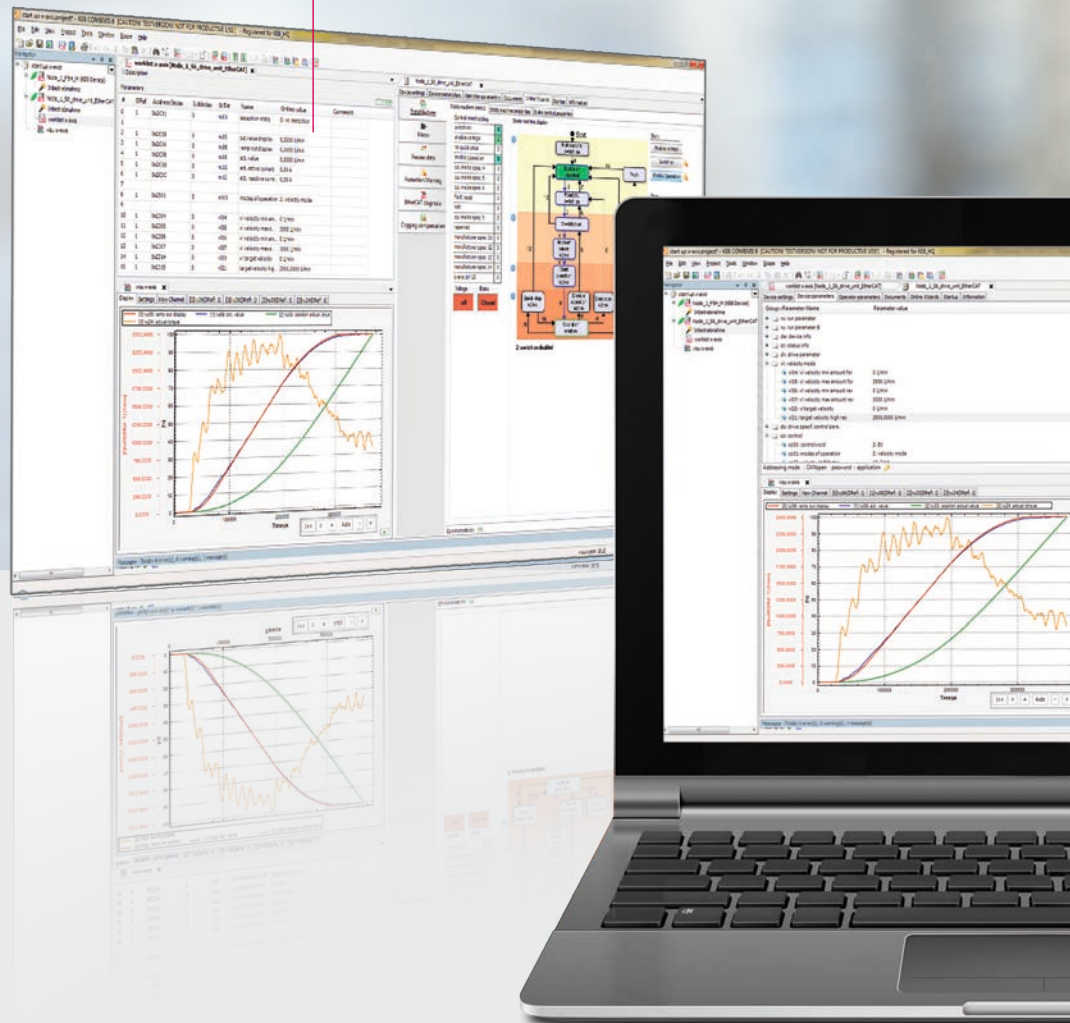

COMBIVIS studio 6

The intelligent automation suite from KEB combines an assistant-guided component selection, fieldbus configuration, drive parameterisation, IEC 61131-3 project generation and motion control. Throughout the planning and layout phase, implementation of control sequences and multi-axis movement profiles, to start-up and fine tuning, the user is supported by a tool developed by experienced application engineers.

With a foundation built on libraries, devices and template databases, rapid and simple solutions can be generated for a wide range of applications.

COMMISSIONING ASSISTANT

- Complete user guidance through the commissioning process
- KEB Motor database, free for extensions
- Anti cogging
- Fieldbus diagnostic and optimisation

SYSTEM CONFIGURATION AS A NEW COMPONENT OF COMBIVIS

- Access to complete KEB product database
- Intuitive gear component selection and system configuration using drag and drop
- Selection assistant with display of compatible components
- Display of all interfaces and connection components
- Material number generator
- Extensive export function for quote list, Combivis Project, Excel ...

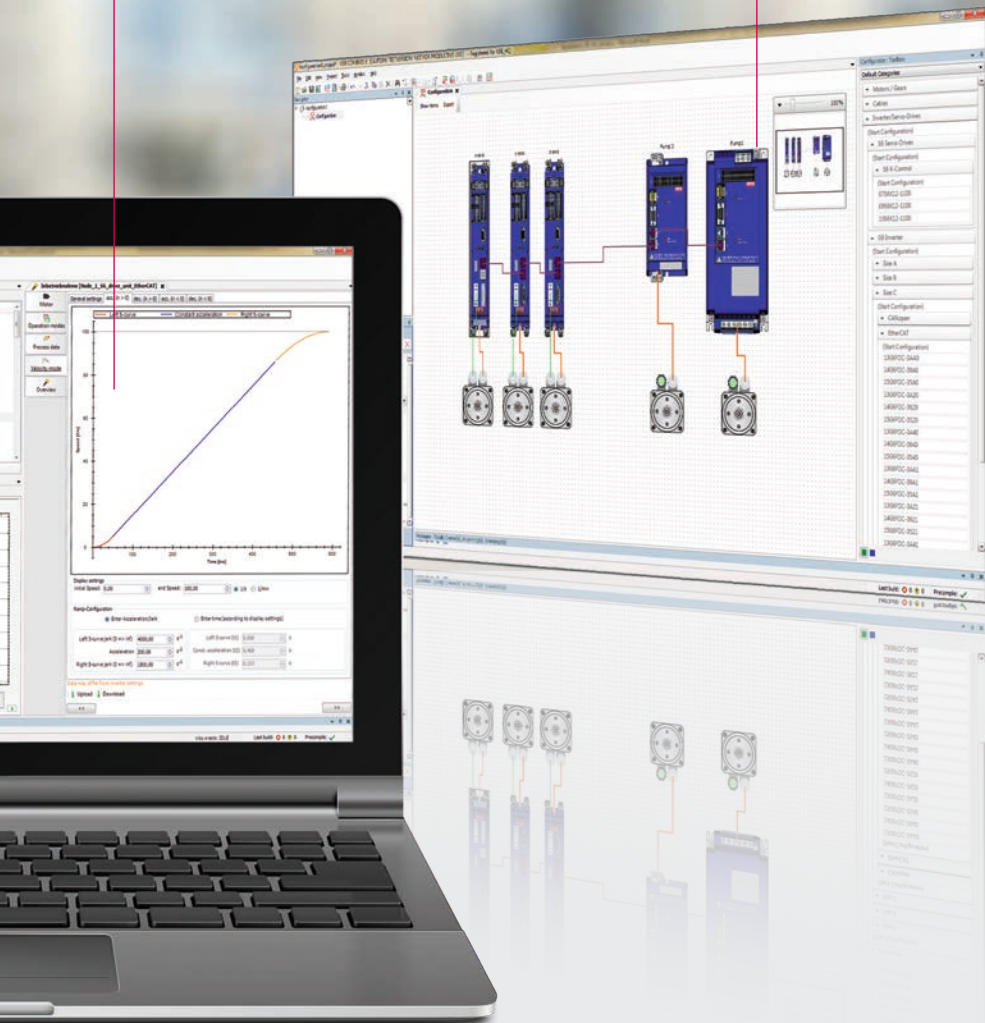

HIGHLIGHTS

- IEC 61131-3 Applications development
- Device and library database
- Product configuration
- Start-up and diagnosis assistant
- COMBIVIS studio HMI integration
- Document database

KEB SERVICE

PERFORMANCE AND COMPETENCE

AFTER-SALES CUSTOMER SUPPORT

- start-up support
- EMC service
- mains analysis
- Insulation, heat or vibration measurements
- conversion of old product series

MAINTENANCE AND REPAIRS

- rush or standard service

COMPONENT AND SPACE PART SUPPLY

- used and new parts for the exchange

PREVENTIVE MAINTENANCE

- forming and cleaning, inspection, functional analysis

CUSTOMER SPECIFIC SERVICE

- individual service support
- system optimisation



KEB WORLDWIDE

Austria | KEB Automation GmbH
Ritzstraße 8 4614 Marchtrenk Austria
Tel: +43 7243 53586-0 Fax: +43 7243 53586-21
E-Mail: info@keb.at Internet: www.keb.at

Belgium | KEB Automation KG
Herenveld 2 9500 Geraardsbergen Belgium
Tel: +32 544 37860 Fax: +32 544 37898
E-Mail: vb.belgien@keb.de Internet: www.keb.de

Brazil | KEB South America – Regional Manager
Rua Dr. Omar Pacheco Souza Riberio, 70
BR-CEP 13569-430 Portal do Sol, São Carlos Brazil
Tel: +55 16 31161294 E-Mail: roberto.arias@keb.de

France | Société Française KEB SASU
Z.I. de la Croix St. Nicolas 14, rue Gustave Eiffel
94510 La Queue en Brie France
Tel: +33 149620101 Fax: +33 145767495
E-Mail: info@keb.fr Internet: www.keb.fr

Germany | Headquarters
KEB Automation KG
Suedstraße 38 32683 Barntrup Germany
Telefon +49 5263 401-0 Fax +49 5263 401-116
E-Mail: info@keb.de Internet: www.keb.de

Germany | Geared Motors
KEB Antriebstechnik GmbH
Wildbacher Straße 5 08289 Schneeberg Germany
Telefon +49 3772 67-0 Fax +49 3772 67-281
E-Mail: info@keb-drive.de Internet: www.keb-drive.de

Italy | KEB Italia S.r.l. Unipersonale
Via Newton, 2 20019 Settimo Milanese (Milano) Italia
Tel: +39 02 3353531 Fax: +39 02 33500790
E-Mail: info@keb.it Internet: www.keb.it

Japan | KEB Japan Ltd.
15 - 16, 2 - Chome, Takanawa Minato-ku
Tokyo 108 - 0074 Japan
Tel: +81 33 445-8515 Fax: +81 33 445-8215
E-Mail: info@keb.jp Internet: www.keb.jp

P. R. China | KEB Power Transmission Technology (Shanghai) Co. Ltd.
No. 435 QianPu Road Chedun Town Songjiang District
201611 Shanghai P. R. China
Tel: +86 21 37746688 Fax: +86 21 37746600
E-Mail: info@keb.cn Internet: www.keb.cn

Republic of Korea | KEB Automation KG
Room 1709, 415 Missy 2000 725 Su Seo Dong
Gangnam Gu 135- 757 Seoul Republic of Korea
Tel: +82 2 6253 6771 Fax: +82 2 6253 6770
E-Mail: vb.korea@keb.de Internet: www.keb.de

Russian Federation | KEB RUS Ltd.
Lesnaya str, house 30 Dzerzhinsky MO
140091 Moscow region Russian Federation
Tel: +7 495 6320217 Fax: +7 495 6320217
E-Mail: info@keb.ru Internet: www.keb.ru

Spain | KEB Automation KG
c / Mitjer, Nave 8 - Pol. Ind. LA MASIA
08798 Sant Cugat Sesgarrigues (Barcelona) Spain
Tel: +34 93 8970268 Fax: +34 93 8992035
E-Mail: vb.espana@keb.de Internet: www.keb.de

Switzerland | KEB Automation AG
Witzbergstraße 24 8330 Pfaeffikon/ZH Switzerland
Tel: +41 43 2886060 Fax: +41 43 2886088
E-Mail: info@keb.ch Internet: www.keb.ch

United Kingdom | KEB (UK) Ltd.
5 Morris Close Park Farm Industrial Estate
Wellingborough, Northants, NN8 6 XF United Kingdom
Tel: +44 1933 402220 Fax: +44 1933 400724
E-Mail: info@keb.co.uk Internet: www.keb.co.uk

United States | KEB America, Inc.
5100 Valley Industrial Blvd. South
Shakopee, MN 55379 United States
Tel: +1 952 2241400 Fax: +1 952 2241499
E-Mail: info@kebameric.com Internet: www.kebameric.com



KEB PARTNERS WORLDWIDE

... www.keb.de/contact/contact-worldwide



Automation with Drive

www.keb.de

KEB Automation KG Suedstrasse 38 32683 Barntrup Germany Tel. +49 5263 401-0 E-Mail: info@keb.de

© KEB 0000000-51H6 01.2019 Subject to technical alterations!