

COMBIVERT



GB INSTRUCTION MANUAL

Control Circuit from V3.2

Translation of original manual	
Mat.No.	Rev.
00F5GEB-K320	2E

KEB



**GB - 3.....GB -
40**

This Instruction Manual describes the control circuit of the KEB COMBIVERT F5 - Series. It is only valid together with the Instruction Manuals Part 1 and Part 2. Both Instruction Manuals must be made available to the user. Prior to performing any work on the unit the user must familiarize himself with the unit. This includes especially the knowledge and observance of the safety and warning directions of Part 1. The pictographs used in this instruction manual have following meaning:



**Danger
Warning
Caution**



**Attention,
observe at
all costs**



**Information
Help
Tip**

1.	General	4
2.	Installation and Connection	5
2.1	Control board BASIC	5
2.1.1	Assignment of Terminal Strip X2A	5
2.1.2	Connection of the control circuit	5
2.1.3	Digital Inputs	6
2.1.4	Analog input	6
2.1.5	Analog output	6
2.1.6	Relay Outputs	6
2.2	Control board Compact/General	7
2.2.1	Assignment of Terminal Strip X2A	7
2.2.2	Connection of the control circuit	8
2.2.3	Digital Inputs	8
2.2.4	Analog Inputs	8
2.2.5	Voltage Input / External Power Supply	9
2.2.6	Digital Outputs	9
2.2.7	Relay Outputs	9
2.2.8	Analog Outputs	9
2.2.9	Voltage Output	9
2.3	Operator	10
3.	Operation of the Unit	11
3.1	Keyboard	11
3.2	Parameter description	12
3.2.1	Password Input	13
3.2.2	Operating Display	13
3.2.3	Basic Adjustment of the Drive	15
3.2.4	Special Adjustments	18
3.4	Drive mode	26
3.4.1	Start/stop drive	26
3.4.2	Changing the direction of rotation	26
3.4.3	Presetting the setpoint	26
3.4.4	Leaving the drive mode	26
4.	Error Assistance	27
7.	Quick Reference	33
8.	Passwords	35

1. **General**

The frequency inverter KEB COMBIVERT F5 is a drive component, which is intended for installation in electrical systems or machines. The frequency inverter is exclusively for stepless speed control / regulation of three-phase motors. The operation of other electrical consumers is not permitted and can lead to the destruction of the unit. KEB COMBIVERT F5 has very extensive programming options. To make the operation and start-up simpler for the user, a special operator level was created in which the most important parameters are found. However, if the parameters pre-defined by KEB are not sufficient for your application an application manual is available.

2. Installation and Connection

2.1 Control board BASIC

X2A

2.1.1 Assignment of Terminal Strip X2A



PIN	Function	Name	Description	
Function				
1	± Set value input 1	AN1+	Voltage input 0...±10 VDC \wedge 0...±CP.11	Resolution: 11bit scan time: 2 ms
Analog output				
5	Analog output 1	ANOUT1	Analog output of the output frequency 0...±10VDC \wedge 0...±100 Hz	I _{max} : 5 mA R _i : 100 Ω Resolution: 12bit
Voltage supply				
7	+10 V Output	CRF	Reference voltage for setpoint potentiometer	+10 VDC +5% / max. 4 mA
8	Analog Mass	COM	Mass for analog in- and outputs	
Digital inputs				
10	Fixed frequency 1	I1	I1+I2 = Fixed frequency 3 (default: 70 Hz) no input = analog set value	13...30VDC ±0% stabilized R _i =2,1 kΩ Scan time 2 ms
11	Fixed frequency 2	I2		
14	Forward	F	Rotation selection; forward has priority	
15	Reverse	R		
16	Control release / Reset	ST	Power modules are enabled; Error Reset at opening	
Voltage supply				
20	24 V-Output	Uout	Approx. 24V output (max.100 mA))	
22	Digital Mass	0V	Potential for digital in-/outputs	
Relay Outputs				
24	NO contact 1	RLA	Fault relay (default); Function can be changed with CP.31	at maximum 30VDC 0.01...1A
25	NC contact 1	RLB		
26	Switching contact 1	RLC		
27	NO contact 2	FLA	Frequency dependent switch (pre-setting); Function can be changed with CP.32	
28	NC contact 2	FLB		
29	Switching contact 2	FLC		

2.1.2 Connection of the control circuit

In order to prevent a malfunction caused by interference voltage supply on the control inputs, the following directions should be observed:

	<ul style="list-style-type: none"> • Use shielded / drilled cables • Lay shield on one side of the inverter onto earth potential • Lay control and power cable separately (about 10...20 cm apart); Lay crossings in a right angle (in case it cannot be prevented)
--	--

Installation and Connection

2.1.3 Digital Inputs

Using of the internal voltage supply

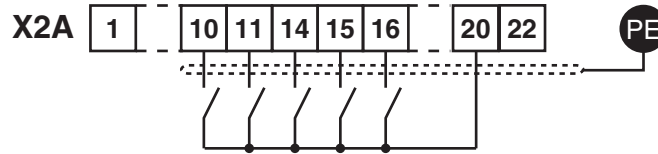

Using of an external voltage supply

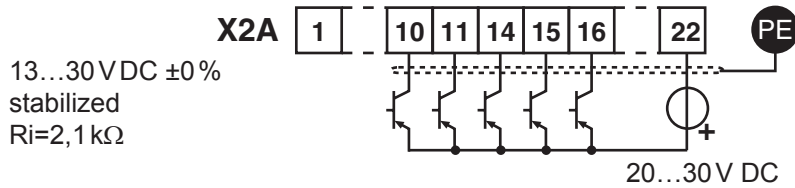

2.1.4 Analog input

Connect unused analog inputs to common, to prevent set value fluctuations!

Internal analog set-point setting

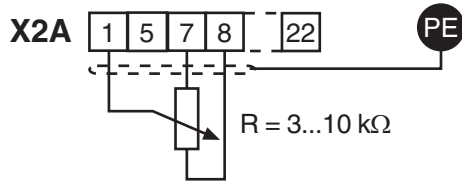

External analog set-point setting

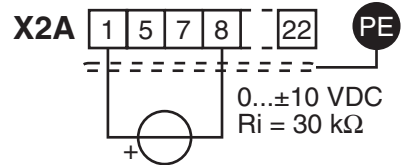

2.1.5 Analog output

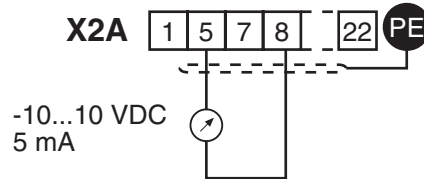

2.1.6 Relay Outputs

In case of inductive load on the relay outputs a protective wiring must be provided (e.g. free-wheeling diode)!

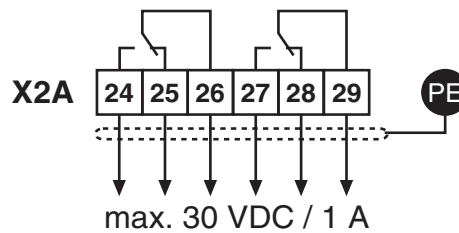

2.2 Control board Compact/General

X2A

2.2.1 Assignment of Terminal Strip X2A



PIN	Function	Name	Description
Analog inputs			
1	+ Set value input 1	AN1+	Differential voltage input 0...±10 VDC ^ 0...±CP.11 Input has no function in the CP mode Resolution / scan time General: 12 Bit / 1 ms Compact: 11 Bit / 2 ms
2	- Set value input 1	AN1-	
3	+ Analog input 2	AN2+	
4	- Analog input 2	AN2-	
Analog outputs			
5	Analog output 1	ANOUT1	Analog output of the output frequency 0...±10VDC ^ 0...±100 Hz
6	Analog output 2	ANOUT2	Analog output of the apparent current 0...10VDC ^ 0...2x rated current
5 mA; Ri=100 Ω Resolution 12 Bit PWM frequency 3,4 kHz Limiting frequency Filter 1. Harmonic 178 Hz			
Voltage supply			
7	+10 V Output	CRF	Reference voltage for setpoint potentiometer
8	Analog Mass	COM	Mass for analog in- and outputs
9			
Digital inputs			
10	Fixed frequency 1	I1	I1+I2 = Fixed frequency 3 (default: 70Hz) no input = analog set value 13...30 VDC ±0% stabilized Ri=2,1 kΩ Scan time 1 ms
11	Fixed frequency 2	I2	
12	External fault	I3	
13	DC braking	I4	
14	Forward	F	
15	Reverse	R	
16	Control release / Reset	ST	
17	Reset	RST	Power modules are enabled; Error Reset at opening Reset; only when an error occurs
Transistor outputs			
18	Speed dependent	O1	Transistor output switched at actual speed = set speed
19	Ready signal	O2	Transistor output switched, as long as no error occurs
Voltage supply			
20	24 V-Output	Uout	Approx. 24V output (max.100 mA))
21	20...30V-Input	Uin	Voltage input for external supply
22	Digital Mass	0V	Potential for digital in-/outputs
23			
Relay Outputs			
24	NO contact 1	RLA	Fault relay (default); Function can be changed with CP.33 at maximum 30VDC 0.01...1A
25	NC contact 1	RLB	
26	Switching contact 1	RLC	
27	NO contact 2	FLA	Frequency dependent switch (pre-setting); Function can be changed with CP.34
28	NC contact 2	FLB	
29	Switching contact 2	FLC	

Installation and Connection

2.2.2 Connection of the control circuit

In order to prevent a malfunction caused by interference voltage supply on the control inputs, the following directions should be observed:



- Use shielded / drilled cables
- Lay shield on one side of the inverter onto earth potential
- Lay control and power cable separately (about 10...20cm apart); Lay crossings in a right angle (in case it cannot be prevented)

2.2.3 Digital Inputs

Using of the internal voltage supply

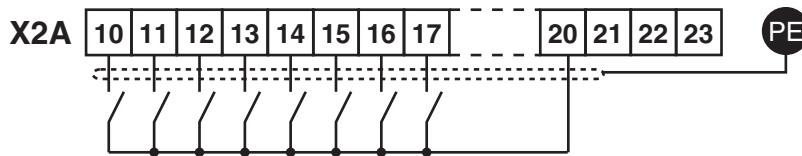

Using of an external voltage supply

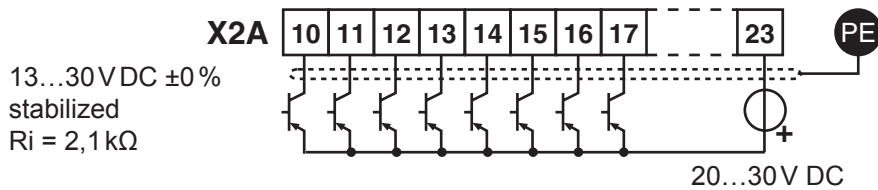

2.2.4 Analog Inputs

Connect unused analog inputs to common, to prevent set value fluctuations!

External analog setpoint setting
(see CP.35)

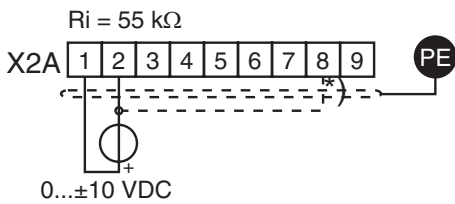

*)

Internal analog set-point setting

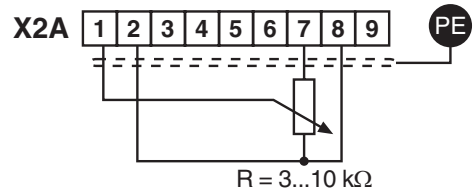

- *) Connect potential equalizing line only if a potential difference of >30V exists between the controls. The internal resistance is reduced to 30 kΩ.

2.2.5 Voltage Input / External Power Supply

The supply of the control circuit through an external voltage source keeps the control in operational condition even if the power stage is switched off. To prevent undefined conditions at external power supply the basic procedure is to first switch on the power supply and after that the inverter.

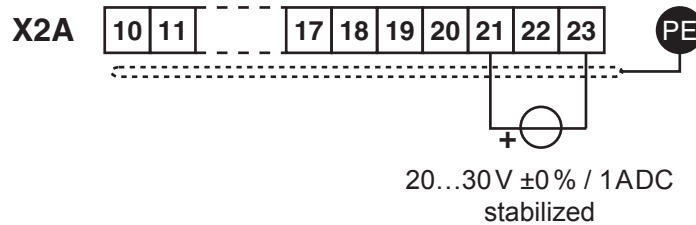

2.2.6 Digital Outputs

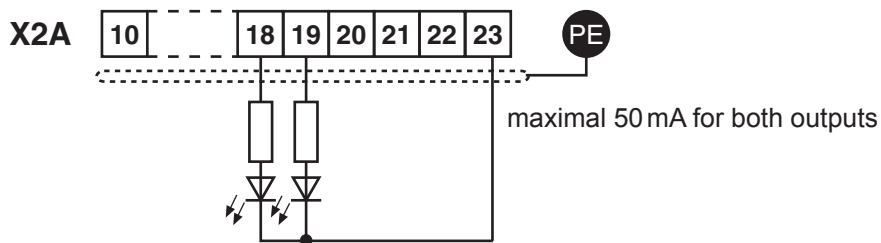

2.2.7 Relay Outputs

In case of inductive load on the relay outputs a protective wiring must be provided (e.g. free-wheeling diode)!

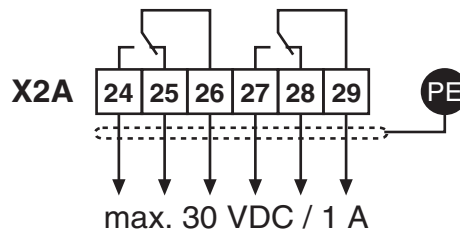

2.2.8 Analog Outputs

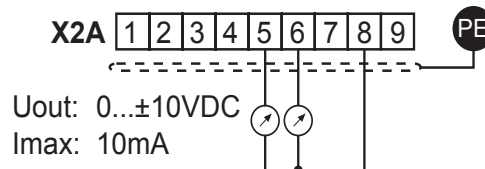

2.2.9 Voltage Output

The voltage output serves for the setting of the digital inputs as well as for the supply of external control elements. Do not exceed the maximum output current of 100 mA.

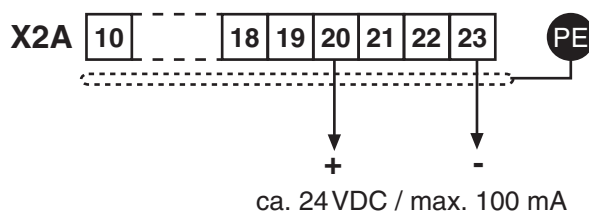

Installation and Connection

2.3 Operator

As an accessory to the local or external (option: cable 00.F5.0C0-1xxx) operation an operator is necessary. To prevent malfunctions, the inverter must be brought into nOP status before connecting / disconnecting the operator (open control release terminal). When starting the inverter, it is started with the last stored values or factory setting.

Digital operator (part number 00.F5.060-1000)		Interface operator (part number 00.F5.060-2000)	
x	x	5-digit LED Display	
x	x	Operating-/Error display Normal "LED on" Error "LED blinks"	
-	x	Interface control Transmit "LED on"	
x	x	Double function keyboard	
-	x	X6B HSP5 programming and diagnostic interface	
-	x	X6C RS232/RS485	

Only use the operator interface for the serial data transfer to RS232/485. The direct connection, PC to the inverter is only valid with a cable (part number 00.F5.0C0-0010), otherwise, it would lead to the destruction of the PC-interface!

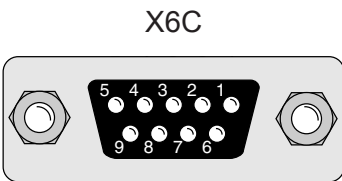

PIN	RS485	Signal	Meaning
1	-	-	reserved
2	-	TxD	transmission signal RS232
3	-	RxD	receive signal RS232
4	A'	RxD-A	receive signal A RS485
5	B'	RxD-B	receive signal B RS485
6	-	VP	Voltage supply +5V (Imax=50 mA)
7	C/C'	DGND	Data reference potential
8	A	TxD-A	transmission signal A RS485
9	B	TxD-B	transmission signal B RS485

RS 232 cable
Part number
0058025-001D
Length 3m

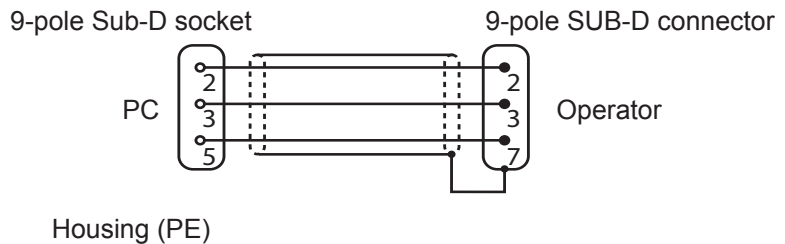

3. Operation of the Unit

3.1 Keyboard

When switching on KEB COMBIVERT F5 the value of parameter CP.1 appears (see Drive mode to switch the keyboard function).

The function key (FUNC) changes between the parameter value and parameter number.



With UP (▲) and DOWN (▼) the value of the parameter number is increased/decreased with changeable parameters.

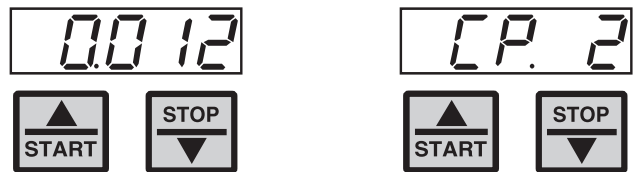

Principally during a change, parameter values are immediately accepted and stored non-volatile. However, with some parameters it is not useful that the adjusted value is accepted immediately. In these cases (CP.28, CP.32, CP.33, CP.34) the adjusted value is accepted and stored non-volatile by pressing ENTER.

If a malfunction occurs during operation, then the actual display is overwritten by the alarm message. The alarm message in the display is reset by ENTER.



With ENTER only the error message in the display is reset. In the inverter status display (CP.3) the error is still displayed. In order to reset the error itself, the cause must be removed or a power-on reset must be made.

Parameter description

3.2 Parameter description

Parameter		Setting range	Resolution	↕	factory setting
CP.00	Password Input	0...9999	1		—
CP.01	Actual frequency display	—	0.0125 Hz		—
CP.02	Set frequency display	—	0.0125 Hz		—
CP.03	Inverter state	—	—		—
CP.04	Apparent current	—	0.1 A		—
CP.05	Apparent current / peak value	—	0.1 A		—
CP.06	Utilization	—	1%		—
CP.07	Intermediate circuit voltage /	—	1 V		—
CP.08	DC link voltage / peak value	—	1 V		—
CP.09	Output voltage	—	1 V		—
CP.10	Minimal frequency	0...400 Hz	0.0125 Hz		0 Hz
CP.11	Maximum frequency	0...400 Hz	0.0125 Hz		70 Hz
CP.12	Acceleration time	0.00...300.00 s	0.01 s		5.00 s
CP.13	Deceleration time (-0,01=CP.12)	-0.01...300.00 s	0.01 s		5.00 s
CP.14	S-curve time	0.00 (off)...5.00s	0.01 s		0.00s (off)
CP.15	Boost	0.0...25.5%	0.1 %		2,0%*
CP.16	rated frequency	0...400 Hz	0.0125 Hz		50 Hz
CP.17	Voltage stabilization	1...650 V (off)	1 V	x	650 (off)
CP.18	Switching frequency	2/4/8/12/16 kHz	—	x	*)
CP.19	Fixed frequency 1	±400 Hz	0.0125 Hz		5 Hz
CP.20	Fixed frequency 2	±400 Hz	0.0125 Hz		50 Hz
CP.21	Fixed frequency 3	±400 Hz	0.0125 Hz		70 Hz
CP.22	DC braking / mode	0...9	1	x	7
CP.23	DC braking / time	0.00...100.00 s	0.01 s		10,00 s
CP.24	Max. ramp current	0...200%	1%		140%
CP.25	Max. constant current	0...200% (off)	1%		200% (off)
CP.26	Speed search / condition	0...15	1	x	8
CP.27	Quick stopping / ramp time	0.00...300.00 s	0.01 s		2,00 s
CP.28	Response of ext. overtemperature	0...7	1		7
CP.29	Analog output 1 / function	0...12 (0...21)	1	x	2
CP.30	Analog output 1 / amplification	±20,00	0.01		1,00
CP.31	Relay output 1 / Function	0...100	1	x	4
CP.32	Relay output 2 / Function	0...100	1	x	27
CP.33	Relay output 2 / Level	±30000,00	0.01		4,00
CP.34	Source of rotation direction	0...9	1	x	2
CP.35	AN1 set value selection	0...2	1	x	0
CP.36	AN1 zero point hysteresis	±10,0%	0.1 %		0,2%

*) depends on the unit size

3.2.1 Password Input

CP.00 Password Input

Ex works the frequency inverter is supplied without password protection, this means that all changeable parameters can be adjusted. After parameterizing the unit can be barred against unauthorized access (Passwords: see last but one page). The adjusted mode is stored.

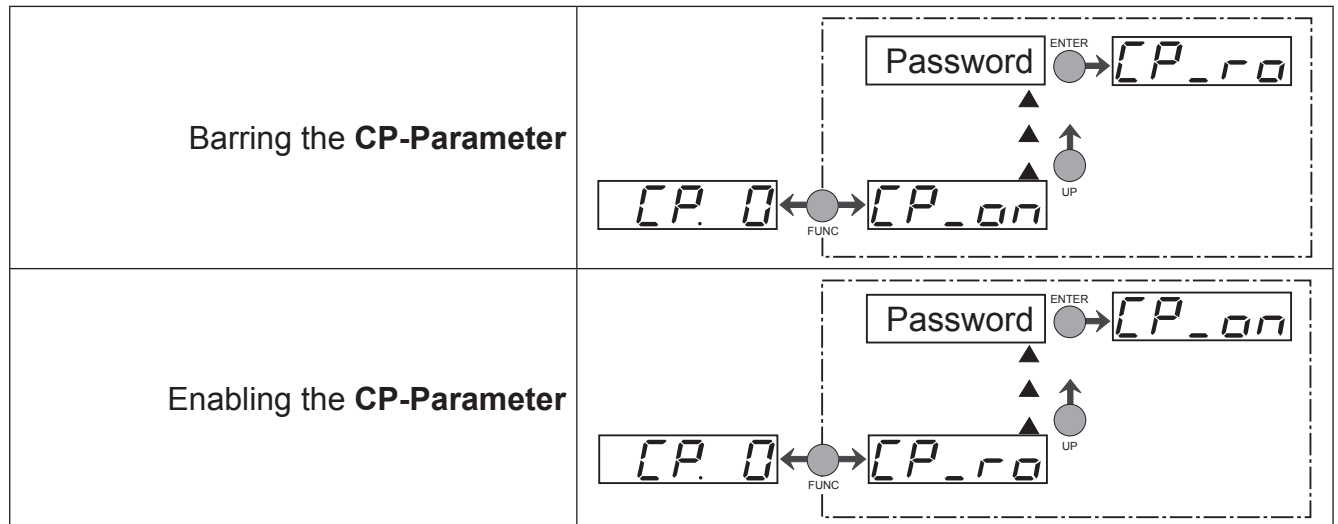

3.2.2 Operating Display

The parameters below serve for the controlling of the frequency inverter during operation.

CP.01 Actual frequency display

Co-domain	Description
0...±400 Hz	Display of the actual output frequency in Hz. Additionally the operator display "noP" and "LS", even if the control release or direction of rotation are not switched (see CP.3). The rotation of the inverter is indicated by the sign. Examples:
18.3	Output frequency 18,3 Hz, rotation forward
-18.3	Output frequency 18,3 Hz, rotation reverse

CP.02 Set frequency display

Co-domain	Description
0...±400 Hz	Display of actually set value. For control reasons the set speed is displayed, even if the control release or direction of rotation are not switched. If no direction of rotation is set, the set speed for clockwise rotation (forward) is displayed.

CP.03 Inverter status

The status display shows the actual working conditions of the inverter. Possible displays and their meanings are:

Display	Status
noP	„no Operation“ control release not bridged; modulation switched off; output voltage = 0V; drive is not controlled.
LS	„Low Speed“ no direction of rotation preset; modulation switched off; output voltage = 0V; drive is not controlled.
FAcc	"Forward Acceleration" drive accelerates with direction of rotation forward.
FdEc	„Forward Deceleration“ drive decelerates with direction of rotation forward.

further on next side

Parameter description

Display	Status
rAcc	"Reverse Acceleration" drive accelerates with direction of rotation reverse.
rdEc	"Reverse Deceleration" drive decelerates with direction of rotation reverse.
Fcon	"Forward Constant" drive runs with a constant speed and direction of rotation forward.
rcon	"Reverse Constant" drive runs with constant speed and direction of rotation reverse.

Other status messages are described at the parameters, where they occur (see chapter 4 „Error diagnosis“).

CP.04 Apparent current

Co-domain	Description
0...±6553.5A	Display of the actual apparent current in ampere.

CP.05 Apparent current / peak value

Co-domain	Description
0...±6553.5A	CP.5 makes it possible to recognize the max. apparent current. For that the highest value of CP.4 is stored in CP.5. The peak value memory can be cleared by pressing the UP, DOWN or ENTER key or over bus by writing any value you like to the address of CP.5. The switch off of the inverter also clears the memory.

CP.06 Utilization

Co-domain	Description
0.0...200.00 %	Display of the actual inverter rate of utilization in percent. 100% rate of utilization is equal to the inverter rated current. Only positive values are displayed, meaning there is no differentiation between motor and generative operation.

CP.07 Intermediate circuit voltage

Display	Description			
0...1000 V	Display of actual DC-link voltage in volt. Typical values:			
	V-class	Normal operation	Overvoltage (E.OP)	Undervoltage (E.UP)
	230 V	300...330 V DC	approx. 400 V DC	approx. 216 V DC
400 V	530...620 V DC	approx. 800 V DC	approx. 240 V DC	

CP.08 DC-link voltage / peak value

Display	Description
0...1000 V	CP.8 makes it possible to recognize short-time voltage rises within an operating cycle. For that the highest value of CP.7 is stored in CP.8. The peak value memory can be cleared by pressing the UP, DOWN or ENTER key or over bus by writing any value you like to the address of CP.8. The switch off of the inverter also clears the memory.

CP.09 Output voltage

Co-domain	Description
0...778 V	Display of the actual output voltage in volt.

3.2.3 Basic Adjustment of the Drive

The following parameters determine the fundamental operating data of the drive. They should be checked and/or adapted to the application.

CP.10 Minimum frequency

Co-domain	Setting	Description
0.0...400.0Hz	0Hz	With this frequency the inverter operates without presetting an analog set value. Internal limiting of the fixed frequencies CP.19...CP.21.

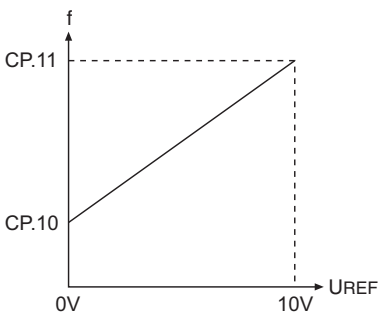

CP.11 Maximum frequency

Co-domain	Setting	Description
0.0...400.0Hz	70Hz	With this frequency the inverter operates with maximum set value. Internal limiting of the fixed frequencies CP.19...CP.21. → CP.10

CP.12 Acceleration time

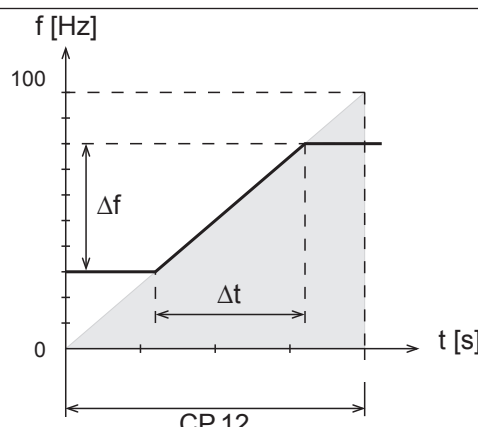
Co-domain	Setting	Description
0.00...300.00 s	5.00 s	The parameter determines the time needed to accelerate from 0 to 100 Hz. The actual acceleration time is proportional to the frequency change (Δf).
Δf Frequency change Δt Acceleration time for Δf		
Example		<p>A drive shall accelerate from 10Hz to 60Hz in 5s.</p> <p>$\Delta f = 60 \text{ Hz} - 10 \text{ Hz} = 50 \text{ Hz}$</p> <p>$\Delta t = 5 \text{ s}$</p> $CP.12 = \frac{\Delta t}{\Delta n} \times 100 \text{ Hz} = \frac{5 \text{ s}}{50 \text{ Hz}} \times 100 \text{ Hz} = 10 \text{ s}$

Parameter description

CP.13 Deceleration time

Co-domain	Setting	Description
-0.01...300.00 s	5.00 s	The parameter determines the time needed to decelerate from 100 Hz to 0 Hz. The actual deceleration time is proportional to the frequency change. At deceleration time = -1 see CP.12 (Display: "=Acc")!
Δf Frequency change Δt Deceleration time for Δf		
Example		<p>The drive should decelerate from 60Hz to 10Hz in 5s.</p> <p>$\Delta f = 60\text{Hz} - 10\text{Hz} = 50\text{Hz}$ $\Delta t = 5\text{s}$</p> <p>$\text{CP.26} = \frac{\Delta t}{\Delta n} \times 100\text{Hz} = \frac{5\text{s}}{50\text{Hz}} \times 100\text{Hz} = 10\text{s}$</p>

CP.14 S-curve time

Co-domain	Setting	Description
0.00 (off)...5.00 s	0.00 s (off)	For some applications it is of advantage when the drive starts and stops jerk-free. This is achieved through a straightening of the acceleration and deceleration ramps. The straightening time, also called S-curve time, can be adjusted with CP.14.
t1	S-curve time (CP.14)	<p>In order to drive defined ramps with activated S-curve time, the acceleration and deceleration times (CP.12 and CP.13) must be adjusted higher than the S-curve time (CP.14).</p>
t2	Acceleration time (CP.12)	
t3	Deceleration time (CP.13)	

CP.15 Boost

Co-domain	Setting	Description
0.0...25.5 %	2%*	In the lower speed range a large part of the motor voltage decreases on the stator resistance. To keep the breakdown torque nearly constant over the entire speed range, the voltage decrease can be compensated by the boost. Adjustment: <ul style="list-style-type: none"> • Determine the rate of utilization in no-load operation • Preset about 10Hz and adjust the boost, so that the same rate of utilization is reached as with the rated frequency.
		When the motor, during continuous operation, drives with low speed and too high voltage it can lead to an overheating of the motor.

CP.16 Rated frequency

Co-domain	Setting	Description
0.00...400.00Hz	50Hz	With the adjusted frequency the inverter reaches in controlled operation a maximal output voltage. The adjustment of the rated motor frequency is typical in this case.
	Motors can overheat when the rated frequency is incorrectly adjusted.	<p>The graph plots output voltage U_A on the vertical axis against frequency f on the horizontal axis. A solid line starts at the origin and increases linearly until it reaches a point labeled 'CP.16'. At this point, the line becomes horizontal, indicating that the output voltage is constant for frequencies above the rated frequency. A shaded triangular area under the linear portion of the line is labeled 'CP.15'.</p>

*) dependent of the power circuit

Parameter description

3.2.4 Special Adjustments

The following parameters serve for the optimization of the drive and the adaption to certain applications. These adjustments can be ignored at the initial start-up.

CP.17 Voltage stabilization

Co-domain	Setting	Description
1...650V (off)	650V (off)	With this parameter a regulated output voltage in relation to the rated frequency can be adjusted. For that reason voltage variations at the input as well as in the intermediate circuit only have a small influence on the output voltage (U/f-characteristic). The function allows an adaption of the output voltage to special motors. The values must be confirmed by „ENTER“. In the example below the output voltage is stabilized to 230V (0% boost).
UN: Mains voltage UA: Output voltage		A: U_A at $U_N = 250V$ unstabilized B: U_A at $U_N = 250V$ stabilized C: U_A at $U_N = 190V$ stabilized D: U_A at $U_N = 190V$ unstabilized

CP.18 Switching frequency

Co-domain	Setting	Description
2 / 4 / 8 / 12 / 16 kHz	dependend of the power circuit	The switching frequency with which the power modules are clocked can be changed depending on the application. The employed power stage determines the maximum switching frequency as well as the factory setting (see manual:part 2). The values must be confirmed by „ENTER“.
Refer to following list to learn about influences and effects of the switching frequency.	low switching frequency	
	less inverter heating	
	less discharge current	
	less switching losses	
	less radio interferences	
improved concentricity with low speed (only open loop!)		high switching frequency
		less noise development
		improved sine-wave simulation
		less motor losses
		improved controller characteristics
	At switching frequencies above 4 kHz pay absolute attention to the max. motor line length in the technical data of the power circuit manual (Part 2).	

CP.19 Fixed frequency 1 (input 1)

CP.20 Fixed frequency 2 (input 2)

CP.21 Fixed frequency 3 (input 2)

	Co-domain	Setting	Description
CP.19	0...±400Hz	5 Hz	Three fixed frequencies can be adjusted. The selection is made by the inputs I1 and I2. If adjustments are made that are outside the fixed limits of CP.10 and CP.11, then the frequency is internally limited. The negative values are released in application mode. The rotation source of the fixed frequencies is not changed by CP.34, it always corresponds to CP.34 = 2.
CP.20		50 Hz	
CP.21		70 Hz	
	Input I1 → Fixed frequency 1 Input I2 → Fixed frequency 2 Input I1 and I2 → Fixed frequency 3		

CP.22 DC braking / Mode

With DC-braking the motor is not decelerated by the ramp. Quick braking is caused by D.C. voltage, which is applied onto the motor winding. This parameter determines how the dc-braking is triggered. The settings must be confirm by „ENTER“.

Value	Setting	Function
0		DC-braking deactivated
1		DC-braking at switch off of the direction of rotation and upon reaching 0 Hz. The braking time is CP.23 or until the next direction of rotation.
2		DC-braking as soon as setting for the direction of rotation is absent.
3		DC-braking as soon as the direction of rotation changes or is absent.
4		DC-braking on disabling the direction of rotation and if the real frequency falls below 4 Hz.
5		DC-braking when the real frequency falls below 4 Hz and the drives decelerates
6		DC-braking as soon as the set value falls below 4 Hz.
7	x	DC-braking when input I4 is switched. At control circuit B = value "0"
8		DC-braking when input I4 is switched. At control circuit B = value "0"
9		DC-braking after switching on the modulation.

CP.23 DC-braking / Time

Co-domain	Setting	Description
0.00... 100.00 s	10 s	If the braking time depends on the actual frequency (CP.22 = 2...7), it is calculated as follows:
$t_B = \frac{CP.23 \times f_B}{100Hz}$		
t_B : Real braking time f_B : Actual frequency		

Parameter description

CP.24 Maximum ramp current

Co-domain	Setting	Description
0...200 %	140 %	This function protects the frequency inverter against switching off through overcurrent during the acceleration ramp. When the ramp reaches the adjusted value, it is stopped so long until the current decreases again. CP.3 displays "LAS" at active function.

CP.25 Maximum constant current

Co-domain	Setting	Description
0...200 % (off)	200 % (off)	This function protects the frequency inverter against switch off through overcurrent during constant output frequency. When exceeding the adjusted value, the output frequency is reduced until the value drops below the adjusted value. CP. 3 displays "SSL" at active function.

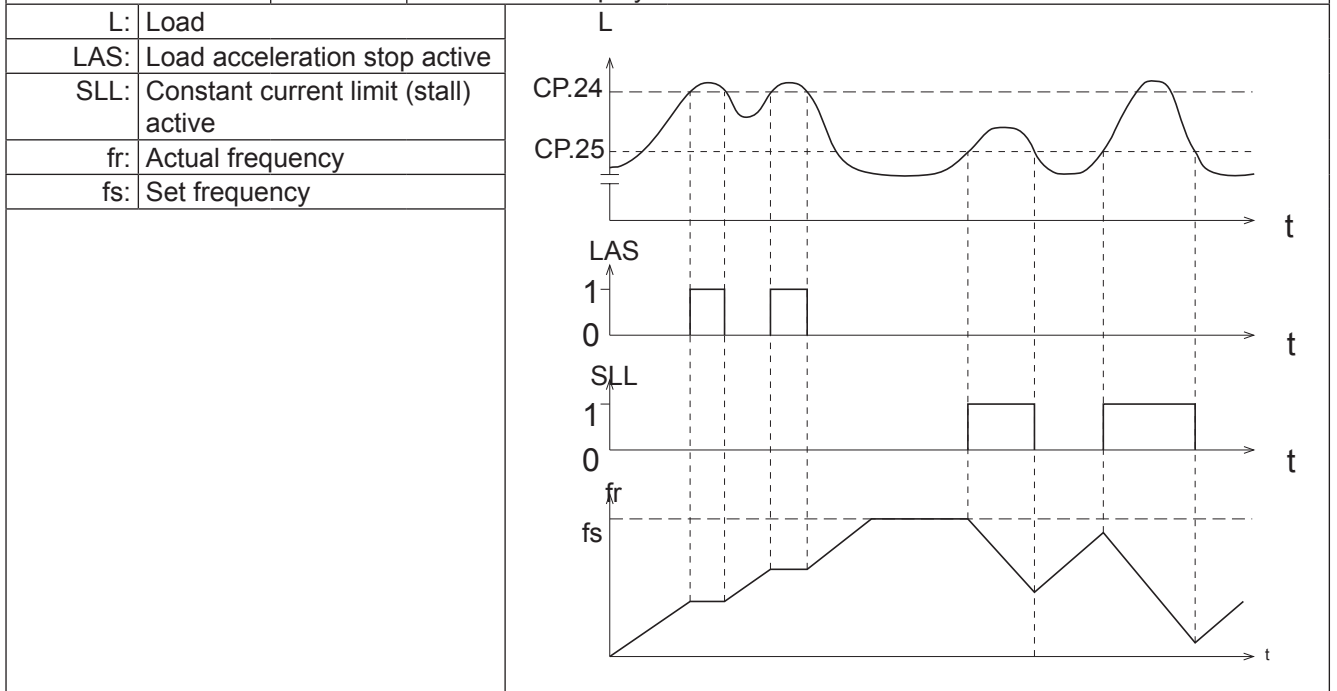

CP.26 Speed search condition

When connecting the frequency inverter onto a decelerating motor, an error can be triggered by the differing rotating field frequencies. With activated speed search the inverter searches for the actual motor speed, adapts its output frequency and accelerates with the adjusted ramp to the given set value. During speed search CP.3 displays "SSF". The parameter determines, under what conditions the functions operate. In case of several conditions the sum of the value must be entered. The settings must be confirm by „ENTER“.

Value	Setting	Function
0		Function off
1		at control release
2		at switch on
4		after reset
8	x	after autoreset
Example:		CP.26 = 12 means after reset and after autoreset UP.

CP.27 Quick stop time

Co-domain	Setting	Description
0.00...300.00 s	2.00 s	The fast-stop function is activated depending on CP.28. The parameter determines the time needed to decelerate from 100 Hz to 0 Hz. The actual deceleration time is proportional to the frequency change. The response to overtemperature (CP.28) is disabled in the factory setting. If it is activated then the modulation switches off automatically after 10s if the motor is still too hot.
Example:		see parameter CP.13

CP.28 Response of external overtemperature

This parameter determines the response of the drive on the external temperature monitoring. In order to activate this function the power circuit terminals T1/T2 must be connected in accordance with the instruction manual Part 2. The response can be adjusted according to following table.

Value	Addition	Setting	Display	Reaction	Restart
0		x	E.dOH	Immediate disabling of modulation	Remove fault; Actuate reset
1	x		A.dOH	Quick stopping; disabling of modulation after reaching speed 0	
2	x			Quick stopping; holding torque at speed 0	
3				Immediate disabling of modulation	Autoreset, if the fault is no longer present
4	x		Quick stopping; disabling of modulation after reaching speed 0		
5	x		Quick stopping; holding torque at speed 0		
6	x		—	No effect on the drive; with CP.31/32 = 9 an external module can be controlled (e. g. fan)	—
7				No effect on the drive; Malfunction is not present; external temperature monitoring is not activated.	
If the motor is still too hot after 10 seconds, the error E.dOH is triggered and the modulation is switched off!					
		If overheat no longer exists, the message E.ndOH (or A.ndOH) is output. Only then the error can be reset or the automatic restart can be carried out.			

Parameter description

CP.29 Analog output 1 / Function

CP.29 defines the function of analog output 1. The settings must be confirm by „ENTER“.

Value	Setting	Reaction	Output
0		Absolute actual frequency (CP.1)	100 Hz = 100 %
1		Absolute set frequency (CP.2)	100 Hz = 100 %
2	x	Actual frequency (CP.1)	±100 Hz = ±100 %
3		Set frequency (CP.2)	±100 Hz = ±100 %
4		Output voltage (CP.9)	500 V = 100 %
5		DC link voltage (CP.7)	1000 V = 100 %
6		Apparent current (CP.4)	2 x rated current = 100 %
7		Active current	±2 x rated current = ±100 %
8...10		Only application mode	—
11		Absoluter active current	2 x rated current = 100 %
12		Power stage temperature	100 °C = 100 %
13		Motor temperature	100 °C = 100 %
14...18		Only application mode	—
19		Ramp output frequency	±100 Hz = ±100 %
20		Absolute ramp output frequency	100 Hz = 100 %
21		Only application mode	—
These values are only present at control type GENERAL!			

CP.30 Analog output 1 / amplification

Co-domain	Setting	Description
-20,00...20,00	1,00	With the amplification the output voltage of the analog output can be tuned the signal to be given out. An amplification of 1 corresponds to ±100 % = ±10 V.
<p>Example: The analog output shall give out +10V at 70 % instead at 100 %.</p> $CP.30 = \frac{100\%}{70\%} = 1,43$		

CP.31 Relay output 1 / function

CP.32 Relay output 2 / function

CP.31 and CP.32 determine the function of the two relay outputs (terminals X2A.24...26 and X2A.27...29). The values must be confirm by „ENTER“.

Value	Setting	Function
0		No function (generally off)
1		Generally on
2		Run signal; also by DC-braking
3		Ready signal (no error)
further on next side		

Value	Setting	Function
4	CP.31	Fault relay
5		Fault relay (not at under voltage error)
6		Warning or error message at abnormal stopping
7		Overload alert signal
8		Overtemperature alert signal power modules
9		External overtemperature alert signal motor
10		Only application mode
11		Overtemperature alert signal interior OHI
12...19		Only application mode
20		Actual value = set value (CP.3 = Fcon; rcon; not at noP, LS, error, SSF)
21		Accelerate (CP.3 = FAcc, rAcc, LAS)
22		Decelerate (CP.3 = FdEc, rdEc, LdS)
23		Real direction of rotation = set direction of rotation
24		Utilization > switching level 1)
25		Active current > switching level 1)
26		Only application mode
27	CP.32	Real value (CP.1) > switching level 1)
28		Setpoint (CP.2) > switching level 1)
29...30		Only application mode
31		Absolute setpoint at AN1 > switching level 1)
32		Absolute setpoint at AN2 > switching level 1)
33		Only application mode
34		Setpoint at AN1 > switching level 1)
35		Setpoint at AN2 > switching level 1)
36...39		Only application mode
40		Hardware current limit activated
41		Modulation on-signal
42...46		Only application mode
47		Ramp output value > switching level 1)
48		Apparent current (CP.4) > switching level 1)
49		Forward running (not at nOP, LS, abnormal stopping or error)
50		Reverse running (not at nOP, LS, abnormal stopping or error)
51		Warning E.OL2
52		Current regulator limit reached
53		Speed regulator limit reached
54...62		Only application mode
63		Absolute value ANOUT1 > switching level 1)
64		Absolute value ANOUT2 > switching level 1)
65		ANOUT1 > switching level 1)
66		ANOUT2 > switching level 1)
67...69		Only application mode
70		Driving current active (safety relay)
71...72		Only application mode
73		Absolut active power > switching level 1)
74		Active power > switching level 1)
75...79		Only application mode
80		Active current > switching level 1)
81		Real value channel 1 > switching level 1)
82		Real value channel 2 > switching level 1)
83		HSP5 bus synchronized
84...100		Only application mode

1) Switching level of CP.31 = 100; The switching level of CP.32 is adjusted by CP.33.

Parameter description

CP.33 Relay output 2 / switching level

Co-domain	Setting	Description
-30000,00...30000,00	4,00	This parameter determines the switching level for the relay output 2 (CP.32). After the switching of the relay, the value can move within a window (hysteresis), without the relay dropping off. Since the operator can display only 5 characters, the last digits are not represented in the case of higher values.
Output variable		Hysteresis
Frequency		0,5 Hz
Actual DC voltage		1 V
Analog set value		0,5%
Active current		0.5 A
Temperature		1 °C

CP.34 Source of rotation direction

Description		
The source rotation setting and the mode of evaluating the rotation setting is defined with this parameter. With CP.34 one does not modify the rotation source of the fixed frequencies (CP.19...21). The settings must be confirmed by „ENTER“.		
Value	Setting	direction of rotation
0...1		Only application mode
2	x	Setting by way of terminal strip forward/reverse; negative values are set to zero
3		Setting by way of terminal strip forward/reverse; the sign of the set point values have no effect on direction of rotation.
4		Setting by way of terminal strip run/stop (X2A.14) and forward/reverse (X2A.15); negative values are set to zero
5		Setting by way of terminal strip run/stop (X2A.14) and forward/reverse (X2A.15); the sign of the set point values have no effect on direction of rotation.
6		Set value dependent; positive value = clockwise rotation; negative value = counterclockwise rotation. Status "Low speed" (LS) if no terminal For or Rev is active.
7		Set value dependent; positive value = clockwise rotation; negative value = counter clockwise rotation; clockwise rotation is indicated if set value is "0"
8...9		Only application mode

Setpoint 0-limited (value 2 and 4)	Setpoint absolute (value 3 and 5)

CP.35 AN1 Set value selection

Description		
The setpoint input 1 (AN1) can be triggered by various signal levels. In order to correctly evaluate the signal, this parameter must be adapted to the signal source. The settings must be confirm by „ENTER“.		
Value	Setting	direction of rotation
0	x	0...±10VDC / Ri= 56 kΩ
1		0...±20mADC / Ri= 250 Ω
2		4...20mADC / Ri= 250 Ω
	At the F5-BASIC control at housing type A or B the signal source may not be re-adjusted.	

CP.36 AN1 zero point hysteresis

Co-domain	Setting	Description
-10.0...10.0%	0,2%	<p>Through capacitive as well as inductive coupling on the input lines or voltage fluctuations of the signal source, the motor connected to the inverter can still drift (tremble) during standstill in spite of the analog input filter. It is the task of the zero point hysteresis to suppress this.</p> <p>With parameter CP.36 the analog signal for the input REF can be faded out in the range of 0...±10%. The adjusted value is applicable for both directions of rotation.</p> <p>If a negative percent value is adjusted the hysteresis acts in addition to the zero point around the current setpoint. Setpoint changes at constant running are accepted only if they are larger than the adjusted hysteresis.</p>

3.4 Drive mode

The Drive Mode is an operating mode of KEB COMBIVERT that permits the manual starting of the drive by the operator (with exception of the LCD Operator). After switching the control release the set value and rotation setting are effected exclusively over the keyboard. In order to activate the drive mode the corresponding password (see last but one page) must be entered in CP. 0. The display switches over as follows:

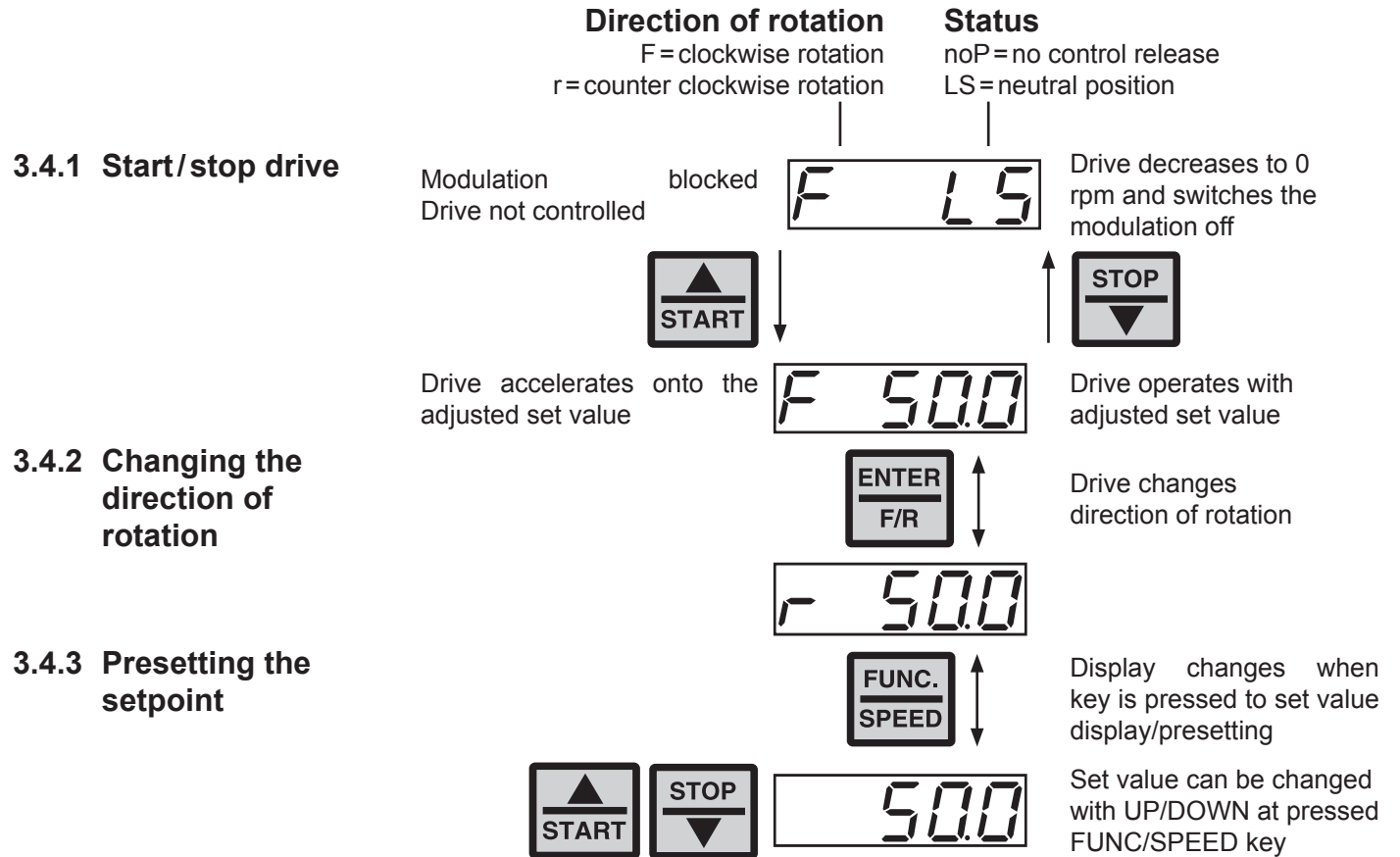

3.4.4 Leaving the drive mode

To exit the drive mode the inverter must be in status "stop" (Display noP or LS). Press the FUNC and ENTER keys simultaneously for about 3 seconds to leave the drive mode. The CP-parameters appear in the display.



4. Error Assistance

At KEB COMBIVERT error messages are always represented with an "E." and the appropriate error in the display. Error messages cause the immediate deactivation of the modulation. Restart possible only after reset or autoreset.

Malfunction are represented with an „A.“ and the appropriate message. Reactions to malfunctions can vary. In the following the display and their cause are described.

Display	COMBIVIS	Value	Meaning
Status Messages			
bbL	base block	76	Power modules for motor de-excitation locked
bon	close brake	85	Brake control, brake engaged (see chapter 6.9)
boFF	open brake	86	Brake control, brake released (see chapter 6.9)
Cdd	calculate drive	82	Measurement of the motor stator resistance.
dcb	DC brake	75	Motor is decelerated by a DC-voltage at the output.
dLS	low speed / DC brake	77	Modulation is switched off after DC-braking (see chapter 6.9 "DC-Braking").
Facc	forward acceleration	64	Acceleration with the adjusted ramps in clockwise direction of rotation.
Fcon	forward constant	66	Acceleration / deceleration phase is completed and it is driven with constant speed / frequency in clockwise direction of rotation.
Fdec	forward deceleration	65	It is stopped with the adjusted ramp times in clockwise direction of rotation.
HCL	hardware current limit	80	The message is output if the output current reaches the hardware current limit.
LAS	LA stop	72	This message is displayed if during acceleration the load is limited to the adjusted load level.
LdS	Ld stop	73	This message is displayed if during deceleration the load is limited to the adjusted load level or the DC-link current to the adjusted voltage level.
LS	low speed	70	No direction of rotation pre-set, modulation is off.
nO_PU	power unit not ready	13	Power circuit not ready or not identified by the control.
noP	no operation	0	Control release (terminal ST) is not switched.
PA	positioning active	122	This message is displayed during a positioning process.
PLS	low speed / power off	84	No modulation after Power-Off.
PnA	position not reachable	123	The specified position cannot be reached within the pre-set ramps. The abort of the positioning can be programmed.
POFF	power off function	78	Depending on the programming of the function (see chapter 6.9 „Power-off Function“) the inverter restarts automatically upon system recovery or after a reset.
POSI	positioning	83	Positioning function active (F5-G).
rAcc	reverse acceleration	67	Acceleration with the adjusted ramp times in anti-clockwise direction of rotation.
rcon	reverse constant	69	Acceleration / deceleration phase is completed and it is driven with constant speed / frequency in clockwise direction of rotation.
rdec	reverse deceleration	68	It is stopped with the adjusted ramp times in anti-clockwise direction of rotation.
rFP	ready for positioning	121	The drive signals that it is ready to start the positioning process.
SLL	stall	71	This message is displayed if during constant operation the load is limited to the adjusted current limit.
SrA	search for ref. active	81	Search for reference point approach active.
SSF	speed search	74	Speed search function active, that means that the inverter attempts to synchronize onto a running down motor.
STOP	quick stop	79	The message is output if as response to a warning signal the quick-stop function becomes active.

further on next side

Error Assistance

Display	COMBIVIS	Value	Meaning
Error Messages			
E. br	Error! brake	56	Error: can occur in the case of switched on brake control (see chapter 6.9.5), if the load is below the minimum load level (Pn.43) at start up or the absence of an engine phase was detected the load is too high and the hardware current limit is reached
E.buS	Error! Watchdog	18	Adjusted monitoring time (Watchdog) of communication between operator and PC / operator and inverter has been exceeded.
E.Cdd	Error! calc. drive data	60	Error: During the automatic motor stator resistance measurement.
E.co1	Error! counter overrun 1	54	Counter overflow encoder channel 1.
E.co2	Error! counter overrun 2	55	Counter overflow encoder channel 2.
E.dOH	Error! drive overheat	9	Error: Overtemperature of motor PTC. Error can only be reset at E.ndOH, if PTC is again low-resistance. Causes: resistance at the terminals T1/T2 >1650 Ohm motor overloaded line breakage to the temperature sensor
E.dri	Error! driver relay	51	Error: Driver relay. Relay for driver voltage on power circuit has not picked up even though control release was given.
E.EEP	Error! EEPROM defective t	21	After reset the operation is again possible (without storage in the EEPROM)
E. EF	Error! external fault	31	Error: External error. Is triggered, if a digital input is being programmed as external error input and trips.
E.EnC	Error! Encoder cable	32	Cable breakage at the resolver or incremental encoder
E.Hyb	Error! hybrid	52	Invalid encoder interface identifier.
E.HybC	Error! hybrid changed	59	Error: Encoder interface identifier has changed, it must be confirmed over ec.0 or ec.10.
E.iEd	Error! input error detect	53	Hardware failure at the NPN/PNP change-over or at the start/stop measurement.
E.InI	Error! initialisation MFC	57	MFC not booted.
E.LSF	Error! load shunt fault	15	Load-shunt relay has not picked up. occurs for a short time during the switch-on phase, but must automatically be reset immediately. If the error message remains the following causes may be applicable: load-shunt defective input voltage wrong or too low high losses in the supply cable braking resistor wrongly connected or damaged braking module defective
E.ndOH	no ERROR drive overheat	11	Motor temperature switch or PTC at the terminals T1/T2 is again in the normal operating range. The error can be reset now.
E.nOH	no E. over heat pow.mod.	36	Temperature of the heat sink is again in the permissible operating range. The error can be reset now.
E.nOHI	no ERROR overheat int.	7	No longer overheating in the interior E.OHI, interior temperature has fallen by at least 3°C
E.nOL	no ERROR overload	17	No more overload, OL-counter has reached 0%; after the error E.OL a cooling phase must elapse. This message appears upon completion of the cooling phase. The error can be reset now. The inverter must remain switched on during the cooling phase.
E.nOL2	no ERROR overload 2	20	The cooling time has elapsed. The error can be reset.
further on next side			

Display	COMBIVIS	Value	Meaning
E. OC	Error! overcurrent	4	Occurs, if the specified peak current is exceeded. Causes:
			acceleration ramps too short
			the load is too big at turned off acceleration stop and turned off constant current limit
			short-circuit at the output
			short-circuit at the output
			deceleration ramp too short
			motor cable too long
			EMC
E. OH	Error! overheat pow.mod.	8	Error: Overtemperature of power module. Error can only be reset at E.nOH. Causes:
			insufficient air flow at the heat sink (soiled)
			ambient temperature too high
E.OH2	Error! motor protection	30	Electronic motor protective relay has tripped.
E.OHI	Error! overheat internal	6	Error: Overheating in the interior: error can only be reset at E.nOHI, if the interior temperature has dropped by at least 3 °C.
E. OL	Error! overload (lxt)	16	Error: Overload error can only be reset at E.nOL, if OL-counter reaches 0% again. Occurs, if an excessive load is applied longer than for the permissible time (see technical data). Causes:
			poor control adjustment (overshooting)
			mechanical fault or overload in the application
			inverter not correctly dimensioned
			motor wrongly wired motor wrongly wired
E.OL2	Error! overload 2	19	encoder damaged
			Occurs if the standstill constant current is exceeded (see technical data and overload characteristics). The error can only be reset if the cooling time has elapsed and E.nOL2 is displayed.
E. OP	Error! Overvoltage	1	Voltage in the DC-link circuit too high. Occurs when the DC bus voltage rises above the permissible value. Causes:
			poor controller adjustment (overshooting)
			input voltage too high
			interference voltages at the input
			deceleration ramp too short
E.OS	Error! over speed	58	braking resistor defective or too small
E.PFC	Error! Power factor control	33	Real speed is bigger than the max. output speed.
E.PrF	Error! prot. rot. for.	46	Error in the power factor control
E.Prr	Error! prot. rot. rev.	47	The drive has driven onto the right limit switch. Programmed response „Error, restart after reset“ (see chapter 6.7 „Response to errors or warning messages“).
			The drive has driven onto the left limit switch. Programmed response „Error, restart after reset“ (see chapter 6.7 „Response to errors or warning messages“).
E. Pu	Error! power unit	12	The drive has driven onto the right limit switch. Programmed response „Error, restart after reset“ (see chapter 6.7 „Response to errors or warning messages“).
E.Puci	Error! Unknown power unit	49	Error: General power circuit fault
			Error: During the initialization the power circuit could not be recognized or was identified as invalid.

further on next side

Error Assistance

Display	COMBIVIS	Value	Meaning
E.Puch	Error! power unit changed	50	Error: Power circuit identification was changed; with a valid power circuit this error can be reset by writing to SY.3. If the value displayed in SY.3 is written, only the power-circuit dependent parameters are reinitialized. If any other value is written, then the default set is loaded. On some systems after writing Sy.3 a Power-On-Reset is necessary.
E.PUCO	Error! Power unit communication	22	Error: Parameter value could not be written to the power circuit. Acknowledgement from LT <> OK
E.PUIN	Error! Power unit invalid	14	Error: Software version for power circuit and control card are different. Error cannot be reset (only at F5-G B-housing)
E.SbuS	Error! bus synchron	23	Synchronization over sercos-bus not possible. Programmed response „Error, restart after reset“.
E.SET	Error! set	39	It has been attempted to select a locked parameter set. Programmed response „Error, restart after reset“.
E.SLF	Error! Software limit switch forward	44	The target position lies outside of the limit defined with the right software limit switch. Programmed response „Error, restart after reset“.
E.SLr	Error! Software limit switch reverse	45	The target position lies outside of the limit defined with the left software limit switch. Programmed response „Error, restart after reset“.
E. UP	Error! underpotential	2	Error: Undervoltage (DC-link circuit) Occurs, if DC-link voltage falls below the permissible value. Causes: input voltage too low or instable inverter rating too small voltage losses through wrong cabling the supply voltage through generator / transformer breaks down at very short ramps at F5-G housing B E.UP is also displayed if no communication takes place between power circuit and control card. jump factor (Pn.56) too small if a digital input was programmed as external error input with error message E.UP (Pn.65).
E.UPh	Error! Phase failure	3	One phase of the input voltage is missing (ripple-detection)
Warning Messages			
A.buS	Warning! Watchdog	93	Warning: Watchdog for communication between operator/control card or operator/PC has responded. The response to this warning can be programmed.
A.dOH	Warning! drive overheat	96	The motor temperature has exceeded an adjustable warning level. The switch off time is started. The response to this warning can be programmed. This warning can be generated only with a special power circuit.
A. EF	Warning! external fault	90	This warning is triggered via an external input. The response to this warning can be programmed.
A.ndOH	All-clear! drive overheat	91	The motor temperature is again below the adjusted warning level. The switch off time is stopped.
A.nOH	All-clear! overheat pow. mod.	88	The heat sink temperature is again below the adjusted warning level.
A.nOHI	All-clear! overheat internal	92	The temperature in the interior of the inverter is again below the warning threshold.
A.nOL	All-clear! overload	98	OL counter has reached 0 %, the warning "overload" can be reset.
A.nOL2	All-clear! overload 2	101	The cooling time after "Warning! Overload during standstill" has elapsed. The warning message can be reset.
A. OH	Warning! overheat pow. mod.	89	A level can be defined, when it is exceeded this warning is output. The response to this warning can be programmed.

further on next side

Display	COMBIVIS	Value	Meaning
A.OH2	Warning! motor protection	97	Warning: electronic motor protective relay has tripped. The response to this warning can be programmed.
A.OHI	Warning! overheat internal	87	The temperature in the interior of the inverter lies above the permissible level. The switch off time was started. The programmed response to this warning message is executed.
A.OL	Warning! overload	99	A level between 0 and 100 % of the load counter can be adjusted, when it is exceeded this warning is output. The response to this warning can be programmed.
A.OL2	Warning! overload 2	100	The warning is output when the standstill continuous current is exceeded (see technical data and overload characteristics). The response to this warning can be programmed. The warning message can only be reset after the cooling time has elapsed and A.nOL2 is displayed.
A.PrF	Warning! prot. rot. for.	94	The drive has driven onto the right limit switch. The response to this warning can be programmed.
A.Prr	Warning! prot. rot. rev.	95	The drive has driven onto the left limit switch. The response to this warning can be programmed.
A.SbuS	Warning! synchron	103	Synchronization over sercos-bus not possible. The response to this warning can be programmed.
A.SET	Warning! set	102	It has been attempted to select a locked parameter set. The response to this warning can be programmed.
A.SLF	Warning! Software limit switch forward	104	The target position lies outside of the limit defined with the right software limit switch. The response to this warning can be programmed.
A.SLr	Warning! Software limit switch reverse	105	The target position lies outside of the limit defined with the left software limit switch. The response to this warning can be programmed.

7. Quick Reference

Display	Parameter	Setting range	Resolution	↵	Customer setting
CP.0	Password Input	0...9999	1		–
CP.1	Actual frequency display	–	0.0125Hz		–
CP.2	Set frequency display	–	0.0125Hz		–
CP.3	Inverter status	–	–		–
CP.4	Apparent current	–	0.1A		–
CP.5	Apparent current / peak value	–	0.1A		–
CP.6	Utilization	–	1%		–
CP.7	Intermediate circuit voltage /	–	1V		–
CP.8	DC link voltage / peak value	–	1V		–
CP.9	Output voltage	–	1V		–
CP.10	Minimal frequency	0...400 Hz	0.0125Hz		
CP.11	Maximum frequency	0...400 Hz	0.0125Hz		
CP.12	Acceleration time	0.00...300.00 s	0.01 s		
CP.13	Deceleration time (-0,01=CP.12)	-0.01...300.00 s	0.01 s		
CP.14	S-curve time	0.00 (off)...5.00 s	0.01 s		
CP.15	Boost	0.0...25.5%	0.1%		
CP.16	rated frequency	0...400 Hz	0.0125Hz		
CP.17	Voltage stabilization	1...650 V (off)	1V	x	
CP.18	Switching frequency	2/4/8/12/16 kHz	-	x	
CP.19	Fixed frequency 1	±400 Hz	0.0125Hz		
CP.20	Fixed frequency 2	±400 Hz	0.0125Hz		
CP.21	Fixed frequency 3	±400 Hz	0.0125Hz		
CP.22	DC braking / mode	0...9	1	x	
CP.23	DC braking / time	0.00...100.00 s	0.01 s		
CP.24	Max. ramp current	0...200%	1%		
CP.25	Max. constant current	0...200% (off)	1%		
CP.26	Speed search / condition	0...15	1	x	
CP.27	Quick stopping / ramp time	0.00...300.00 s	0.01 s		
CP.28	Response of ext. overtemperature	0...7	1		
CP.29	Analog output 1 / function	0...12 (0...21)	1	x	
CP.30	Analog output 1 / amplification	±20,00	0.01		
CP.31	Relay output 1 / Function	0...100	1	x	
CP.32	Relay output 2 / Function	0...100	1	x	
CP.33	Relay output 2 / function	±30000.00	0.01		
CP.34	Source of rotation direction	0...9	1	x	
CP.35	AN1 set value selection	0...2	1	x	
CP.36	AN1 zero point hysteresis	±10,0%	0.1%		

Passwords

8. Passwords

Read only		Read/Write		Drive mode
100		200		500



KEB Automation KG

Südstraße 38 • D-32683 Barntrup
fon: +49 5263 401-0 • fax: +49 5263 401-116
net: www.keb.de • mail: info@keb.de

KEB worldwide...

KEB Antriebstechnik Austria GmbH

Ritzstraße 8 • A-4614 Marchtrenk
fon: +43 7243 53586-0 • fax: +43 7243 53586-21
net: www.keb.at • mail: info@keb.at

KEB Antriebstechnik

Herenveld 2 • B-9500 Geraardsbergen
fon: +32 5443 7860 • fax: +32 5443 7898
mail: vb.belgien@keb.de

KEB Power Transmission Technology (Shanghai) Co.,Ltd.

No. 435 Qianpu Road, Chedun Town, Songjiang District,
CHN-Shanghai 201611, P.R. China
fon: +86 21 37746688 • fax: +86 21 37746600
net: www.keb.de • mail: info@keb.cn

KEB Antriebstechnik Austria GmbH

Organizační složka
K. Weise 1675/5 • CZ-370 04 České Budějovice
fon: +420 387 699 111 • fax: +420 387 699 119
mail: info.keb@seznam.cz

KEB Antriebstechnik GmbH

Wildbacher Str. 5 • D-08289 Schneeberg
fon: +49 3772 67-0 • fax: +49 3772 67-281
mail: info@keb-drive.de

KEB España

C/ Mitjer, Nave 8 - Pol. Ind. LA MASIA
E-08798 Sant Cugat Sesgarrigues (Barcelona)
fon: +34 93 897 0268 • fax: +34 93 899 2035
mail: vb.espana@keb.de

Société Française KEB

Z.I. de la Croix St. Nicolas • 14, rue Gustave Eiffel
F-94510 LA QUEUE EN BRIE
fon: +33 1 49620101 • fax: +33 1 45767495
net: www.keb.fr • mail: info@keb.fr

KEB (UK) Ltd.

Morris Close, Park Farm Industrial Estate
GB-Wellingborough, NN8 6 XF
fon: +44 1933 402220 • fax: +44 1933 400724
net: www.keb-uk.co.uk • mail: info@keb-uk.co.uk

KEB Italia S.r.l.

Via Newton, 2 • I-20019 Settimo Milanese (Milano)
fon: +39 02 3353531 • fax: +39 02 33500790
net: www.keb.de • mail: kebitalia@keb.it

KEB Japan Ltd.

15-16, 2-Chome, Takanawa Minato-ku
J-Tokyo 108-0074
fon: +81 33 445-8515 • fax: +81 33 445-8215
mail: info@keb.jp

KEB Korea Seoul

Room 1709, 415 Missy 2000
725 Su Seo Dong, Gang Nam Gu
ROK-135-757 Seoul/South Korea
fon: +82 2 6253 6771 • fax: +82 2 6253 6770
mail: vb.korea@keb.de

KEB RUS Ltd.

Lesnaya Str. House 30, Dzerzhinsky (MO)
RUS-140091 Moscow region
fon: +7 495 632 0217 • fax: +7 495 632 0217
net: www.keb.ru • mail: info@keb.ru

KEB Sverige

Box 265 (Bergavägen 19)
S-43093 Hälsö
fon: +46 31 961520 • fax: +46 31 961124
mail: vb.schweden@keb.de

KEB America, Inc.

5100 Valley Industrial Blvd. South
USA-Shakopee, MN 55379
fon: +1 952 224-1400 • fax: +1 952 224-1499
net: www.kebamerica.com • mail: info@kebamerica.com

More and latest addresses at <http://www.keb.de>

© KEB	
Mat.No.	00F5GEB-K320
Rev.	2E
Date	10/2016