



EMBEDDED IPCs

INSTRUCTIONS FOR USE | E22 BOX/PANEL

Original Manual
Document 20146638 EN 03



Preface

The hardware and software described in this document are products of KEB. The information contained in this document is valid at the time of publishing. KEB reserves the right to update this document in response to misprints, mistakes or technical changes.

Signal words and symbols

Certain procedures within this document can cause safety hazards during the installation or operation of the device. Refer to the safety warnings in this document when performing these procedures. Safety signs are also located on the device where applicable. A safety warning is marked by one of the following warning signs:

DANGER	Dangerous situation, which will cause death or serious injury if this safety warning is ignored.
WARNING	Dangerous situation, which may cause death or serious injury if this safety warning is ignored.
CAUTION	Dangerous situation, which may cause minor injury if this safety warning is ignored.
NOTICE	Situation, which can cause damage to property if this safety warning is ignored.

RESTRICTION

Used when the following statements depend on certain conditions or are only valid for certain ranges of values.



Used for informational messages or recommended procedures.

More symbols

- ▶ This arrow starts an action step.
- / - Enumerations are marked with dots or indents.
- => Cross reference to another chapter or another page.



Note to further documentation.
www.keb.de/service/downloads



Laws and guidelines

KEB Automation KG confirms with the EC declaration of conformity and the CE mark on the device nameplate that it complies with the essential safety requirements.

The EC declaration of conformity can be downloaded on demand via our website.

Warranty and liability

The warranty and liability on design, material or workmanship for the acquired device is given in the general sales conditions.



Here you will find our general sales conditions.
www.keb.de/terms-and-conditions



Further agreements or specifications require a written confirmation.

Support

Although multiple applications are referenced, not every case has been taking into account. If you require further information or if problems occur which are not referenced in the documentation, you can request the necessary information via the local KEB agency.

The use of our units in the target products is outside of our control and therefore lies exclusively in the area of responsibility of the customer.

The information contained in the technical documentation, as well as any user-specific advice in spoken and written and through tests, are made to best of our knowledge and information about the intended use. However, they are regarded as being only informal and changes are expressly reserved, in particular due to technical changes. This also applies to any violation of industrial property rights of a third-party. Selection of our units in view of their suitability for the intended use must be done generally by the user.

Tests can only be done within the intended end use of the product (application) by the customer. They must be repeated, even if only parts of hardware, software or the unit adjustment are modified.

Copyright

The customer may use the instructions for use as well as further documents or parts from it for internal purposes. Copyrights are with KEB and remain valid in its entirety.

This KEB product or parts thereof may contain third-party software, including free and/or open source software. If applicable, the license terms of this software are contained in the instructions for use. The instructions for use are already available to you, can be downloaded free of charge from the KEB website or can be requested from the respective KEB contact person.

Other wordmarks or/and logos are trademarks (™) or registered trademarks (®) of their respective owners.

Table of Contents

- Preface 3**
 - Signal words and symbols 3
 - More symbols..... 3
 - Laws and guidelines..... 4
 - Warranty and liability 4
 - Support 4
 - Copyright..... 4
- Table of Contents 5**
- List of Figures..... 10**
- List of Tables 13**
- Glossary 14**
- Standards for control & automation..... 15**

- 1 Basic Safety Instructions..... 17**
 - 1.1 Target Group 17
 - 1.2 Transport, storage and proper use 18
 - 1.3 Installation..... 18
 - 1.4 Electrical connection 19
 - 1.5 Start-up and operation 19
 - 1.6 Maintenance..... 19
 - 1.7 Repair 20
 - 1.8 Disposal..... 20

- 2 System Description 21**
 - 2.1 Key features 21**
 - 2.1.1 New KEB standards 21
 - 2.1.1.1 Front Panels in different versions..... 21
 - 2.1.1.2 KEB Cutout..... 22
 - 2.1.1.3 Isolated power supply 22
 - 2.1.1.4 Fieldbuses 22
 - 2.1.2 Optional fieldbus cards..... 22
 - 2.1.3 LCD LED backlight..... 22
 - 2.2 Packaging..... 23**
 - 2.3 Front Panels..... 23**
 - 2.3.1 Full aluminium front panel 24
 - 2.3.2 Capacitive front panel..... 26
 - 2.3.3 LCD aspect ratio..... 28
 - 2.3.4 Front-USB 2.0 29
 - 2.3.4.1 Open silicone cover..... 29
 - 2.4 C6 E22 Box..... 30**
 - 2.5 SL - S1 different depths / add-on slots 31**
 - 2.6 Rear..... 32**

2.6.1 Expansion slot area.....	32
2.6.2 Voltage supply.....	32
2.6.3 LED buttons.....	33
2.6.4 Connectors area.....	34
2.6.5 Additional area.....	35
2.6.6 Micro UPS.....	37
2.6.7 Labels position.....	38
2.6.7.1 Nameplate.....	39
2.6.7.2 Connections and label details for size SL and S1.....	39
2.7 Rear view.....	40
2.8 Side view.....	41
2.9 Touchscreen.....	41
2.9.1 5-wire resistive technology.....	42
2.9.2 Multi-touch technology.....	42

3 Installation and Connection..... 43

3.1 Preparation for installation.....	43
3.1.1 Select the mounting location.....	43
3.2 Checking the package contents.....	43
3.3 Checking the operating conditions.....	43
3.4 Installation.....	43
3.5 Avoid damage due to overheating.....	44
3.5.1 Checking installation distances.....	44
3.6 Selection of the mounting plate.....	46
3.6.1 Degree of protection.....	46
3.7 System and cutout dimension.....	47
3.7.1 C6 E22 Panel resistive.....	47
3.7.2 C6 E22 Panel capacitive.....	48
3.7.3 C6 E22 Box.....	48
3.8 Mounting the device.....	49
3.8.1 Position of the mounting clamps.....	49
3.8.2 Tools to tighten the mounting clamps.....	50
3.8.3 Procedure.....	50
3.9 Connect C6 E22 BOX/PANEL.....	52
3.9.1 Information for the connection.....	52
3.9.2 Grounding and bonding.....	52
3.9.3 Galvanic isolation of the power supply.....	53
3.9.4 Power supply connection.....	54
3.9.5 Power connection assembly.....	54
3.9.6 Power on.....	58
3.9.6.1 LED power supply.....	59
3.9.6.2 Front On/Off/Standby LED.....	59

4	Operating Systems	60
4.1	KEB Windows Images (Windows Embedded Standard 7 / Windows 10).....	60
4.1.1	Introduction.....	60
4.1.2	User Accounts	60
4.1.3	Ethernet Address.....	60
4.1.4	Usage of storage memories	61
4.1.5	Firewall.....	62
4.1.6	eGalax Touch Driver.....	63
4.2	Windows Updates.....	64
4.3	EFW implementation in the Windows Embedded Standard 7 images	64
4.4	KEB Write Filter Manager (KEB-WF_MGR)	65
4.4.1	Introduction.....	65
4.4.2	How EWF works.....	65
4.4.3	Protectable volumes.....	66
4.4.4	KEB EWF configuration.....	66
4.4.5	Delivery state of EWF on KEB devices	66
4.4.6	Using KEB_WF_Mgr	67
4.4.7	Dependent Volumes (typically E:\)	69
4.4.8	Leave the KEB_WF_Mgr.....	70
4.5	KEB UWF Manager	71
4.5.1	Introduction.....	71
4.5.2	Functioning of the UWF	71
4.5.3	KEB UWF configuration and usage.....	71
4.6	KEB Linux Image	73
4.6.1	Introduction.....	73
4.6.2	Service user accounts	73
4.6.3	Change password for service user.....	74
4.6.4	Ethernet IP Address	75
4.6.5	Usage of storage memories	75
4.7	Common (Windows and Linux).....	76
4.7.1	Micro-UPS Handling.....	76
4.7.2	Ip-Scan	77
4.7.3	Serial interface	78
5	Maintenance and Service.....	79
5.1	Installation.....	80
5.1.1	Removal	81
5.2	Backup battery replacement (CR2032 3V)	82
5.3	Touchscreen calibration	84
5.3.1	Touchscreen application tips	86
5.3.2	Maintaining & cleaning	86
5.3.3	Procedure.....	87

5.4	Technical support & repairs	87
5.5	Recycling and disposal.....	87
6	Technical Specifications	88
6.1	LCD characteristics.....	88
6.2	C6 E22 PANEL resistive - Technical data	90
6.3	C6 E22 PANEL capacitive - Technical data	92
6.4	C6 E22 Box Technical data	94
6.5	Power consumption	95
6.5.1	Calculation of the absorbed power.....	95
6.5.2	This is how you determine the power consumption	96
6.5.2.1	Basic system	96
6.5.2.2	Options	97
6.5.3	How to select the 24 V DC voltage supply	97
7	Drawings.....	98
7.1	Drawings	98
7.1.1	C6 E22 PANEL / SL / 10.1" W	98
7.1.2	C6 E22 PANEL / SL-S1 / 10.4"	99
7.1.3	C6 E22 PANEL / SL-S1 / 12.1"	100
7.1.4	C6 E22 PANEL / SL-S1 / 12.1" W	101
7.1.5	C6 E22 PANEL SL-S1 / 15.0"	102
7.1.6	C6 E22 PANEL / SL-S1 / 15.6" W	103
7.1.7	C6 E22 PANEL / SL-S1 / 17.0"	104
7.1.8	C6 E22 PANEL / SL-S1 / 18.5" W	105
7.1.9	C6 E22 PANEL / SL-S1 / 19.0"	106
7.1.10	C6 E22 PANEL / SL-S1 / 21.5" W	107
7.1.11	C6 E22 PANEL / SL-S1 / 24.0" W.....	108
7.1.12	C6 E22 Box SL-S1	109
7.2	LED description	110
7.2.1	DL4 - Thermal LED Alarm	110
7.2.2	Front LED - On/OffUPS LED.....	111
7.2.3	DL2 - Watchdog LED	111
7.2.4	DL1 - Power on / Standby LED	111
7.2.5	DL3 - Mass storage device LED.....	111
7.2.6	LAN LED	111
7.3	Key description.....	112
7.3.1	SW3 System reset key.....	112
7.3.2	SW2 Watchdog reset key.....	112
7.4	Description of the external connections	112
7.5	Technical support & repairs	113
8	Certificates and Approvals	114

8.1 EU Declaration of Conformity 114
8.2 UL approval..... 116
8.3 RoHs Declaration of Conformity..... 116

List of Figures

Figure 1:	Isolated power supply	22
Figure 2:	Detail front panel resistive.....	23
Figure 3:	Detail front panel capacitive.....	24
Figure 4:	Detail front panel resistive (the figure shows a 15.0" display as example).....	24
Figure 5:	Construction details	25
Figure 6:	Details front panel capacitive (the figure shows a 15.6" display as example)	26
Figure 7:	Features front panel capacitive.....	26
Figure 8:	Construction details	27
Figure 9:	4 : 3 Example of an aspect ratio	28
Figure 10:	5 : 4 Example of an aspect ratio	28
Figure 11:	16 : 9 (widescreen) Example for an aspect ratio.....	29
Figure 12:	Front USB details.....	29
Figure 13:	Front USB details - Opening the silicone cover	29
Figure 14:	C6 E22 Box details	30
Figure 15:	„SL“ details.....	31
Figure 16:	„S1“ details.....	31
Figure 17:	Rear	32
Figure 18:	Expansion slot.....	32
Figure 19:	Voltage supply.....	32
Figure 20:	DC voltage supply.....	33
Figure 21:	LED buttons	33
Figure 22:	LED buttons	34
Figure 23:	Connectors area	34
Figure 24:	Connectors area	35
Figure 25:	Additional area	35
Figure 26:	Nameplate SL	38
Figure 27:	Nameplate S0	38
Figure 28:	Marking label details	39
Figure 29:	Connections label details size SL	39
Figure 30:	Connections label details size S1	39
Figure 31:	Rear view SL.....	40
Figure 32:	Rear view S1.....	40
Figure 33:	Rear view SL- side view.....	41
Figure 34:	Standard 5-wire resistive touchscreen technology details	42
Figure 35:	Details front panel capacitive	42
Figure 36:	Mounting distances	45
Figure 37:	Mounting distances - side view	45
Figure 38:	Installation position inclined	46
Figure 39:	C6 E22 Panel resistive dimensions	47
Figure 40:	C6 E22 Panel capacitive dimensions.....	48
Figure 41:	C6 E22 Box SL dimensions	48
Figure 42:	C6 E22 Box S1 dimensions	48
Figure 43:	Installation.....	50

Figure 44:	Installation.....	50
Figure 45:	Installation.....	51
Figure 46:	Installation.....	51
Figure 47:	Connection details of the power supply	52
Figure 48:	Power supply connection detail	53
Figure 49:	Power supply connection detail	53
Figure 50:	C6 E22 BOX/PANEL Detail.....	54
Figure 51:	Power connector assembly.....	54
Figure 52:	Power connector assembly.....	55
Figure 53:	Power connector assembly.....	55
Figure 54:	Power connector assembly.....	55
Figure 55:	Cup installation	56
Figure 56:	Cup installation	56
Figure 57:	Cup installation	57
Figure 58:	Power connector assembly.....	57
Figure 59:	Power on.....	58
Figure 60:	Power on.....	58
Figure 61:	Remove CFast slot cover.....	79
Figure 62:	CFast slot details	80
Figure 63:	CFast installation	81
Figure 64:	Remove CFast.....	81
Figure 65:	Battery replacement.....	82
Figure 66:	Battery replacement.....	82
Figure 67:	Battery replacement.....	83
Figure 68:	Battery replacement.....	83
Figure 69:	Calibration of the touchscreen	84
Figure 70:	Calibration of the touchscreen	84
Figure 71:	Calibration of the touchscreen	85
Figure 72:	Calibration of the touchscreen	85
Figure 73:	10.1" W dimensions	98
Figure 74:	10.4" dimensions.....	99
Figure 75:	12.1" dimensions.....	100
Figure 76:	12.1" Wide dimensions	101
Figure 77:	15.0" dimensions.....	102
Figure 78:	15.6" W dimensions	103
Figure 79:	17.0" dimensions.....	104
Figure 80:	18.5" W dimensions	105
Figure 81:	19.0" dimensions.....	106
Figure 82:	21.5" W dimensions	107
Figure 83:	24.0" W dimensions	108
Figure 84:	C6 E22 BOX SL.....	109
Figure 85:	C6 E22 BOX S1.....	109
Figure 86:	Details LED position.....	110
Figure 87:	Details LED position.....	110
Figure 88:	Key position details.....	112

LIST OF FIGURES

Figure 89: External connections..... 112
Figure 90: External connections..... 113
Figure 91: Key position details..... 113

List of Tables

Table 1:	Packaging	23
Table 2:	Features front panels resistive.....	25
Table 3:	Micro UPS data.....	37
Table 4:	Touchscreen.....	41
Table 5:	C6 E22 Panel resistive dimensions	47
Table 6:	C6 E22 Panel capacitive dimensions.....	48
Table 7:	Position of the mounting clamps.....	49
Table 8:	LED power supply.....	59
Table 9:	Front On/Off/Standby LED.....	59
Table 10:	User Accounts.....	60
Table 11:	Volume protection	66
Table 12:	LCD characteristics.....	88
Table 13:	C6 E22 BOX/PANEL Technical data	90
Table 14:	Common options.....	91
Table 15:	C6 E22 PANEL Technical data.....	92
Table 16:	Common options.....	93
Table 17:	C6 E22 Box Technical data.....	94
Table 18:	Common options.....	95
Table 19:	Basic system consumption	97
Table 20:	Front LED - On/Off/UPS LED	111
Table 21:	Power on / Standby LED.....	111
Table 22:	LAN LED	112

Glossary

0V	Earth-potential-free common point	KEB product	The KEB product is subject of this manual.
1ph	1-phase mains	KEB-I/O	Small control system from the KEB-I/O system
3ph	3-phase mains	EtherCAT SPS	
AC	AC current or voltage	KEB-I/O EtherCAT System	I/O module family
Application	The application is the intended use of the KEB product.	Manufacturer	The manufacturer is KEB, unless otherwise specified (e.g. as manufacturer of machines, engines, vehicles or adhesives).
ASCL	Asynchronous sensorless closed loop	MCM	American unit for large wire cross sections
AWG	American wire gauge	MTTF	Mean service life to failure
B2B	Business-to-business	NN	Sea level
CAN	Fieldbus system	PE	Protective earth
CODESYS	Operating system of the standard control and programming environment	PELV	Protective Extra Low Voltage
CODESYS Safety-PS	Safety programming system	PFD	Term used in the safety technology (EN 61508-1...7) for the size of error probability
COM-BIVERT	KEB drive converters	PFH	Term used in the safety technology (EN 61508-1...7) for the size of error probability per hour
COMBIVIS	KEB start-up and parameterizing software	PLC	Programmable logic controller
Customer	The customer has purchased a KEB product from KEB and integrates the KEB product into his product (customer product) or resells the KEB product (dealer)	POU	Program Organization Unit
DC	DC current or voltage	RJ45	Modular connector with 8 lines
DIN	German Institut for standardization	Safety Package	Plug in for COMBIVIS studio 6 with safety functionally
EMC	Electromagnetic compatibility	Safety PLC	Safety programmable logic controller
Emergency stop	Shutdown of a drive in emergency case (not de-energized)	Safety PLCopen	Library of the certified basic level safety blocks
Emergency switching off	Switching off the voltage supply in emergency case	SELV	Safety Extra Low Voltage (<60 V)
EN	European standard	SIL	The security integrity level is a measure for quantifying the risk reduction. Term used in the safety technology (EN 61508 -1...7)
End customer	The end customer is the user of the customer product.	USB	Universal serial bus
EtherCAT	Real-time Ethernet bus system of the company Beckhoff		
Ethernet	Real-time bus system - defines protocols, plugs, types of cables		
FE	Functional earth		
FSoE	Functional Safety over Ethernet		
GND	Reference potential, ground		
Head module	Description for the bus coupler or small control in the KEB-I/O EtherCat system		
HMI	Human machine interface (touch screen)		
IEC	International standard		
IP xx	Degree of protection (xx for level)		

Standards for control & automation

DGUV regulation 3	Electrical installations and equipment
DIN 46228-1	Wire-end ferrules; Tube without plastic sleeve
DIN 46228-4	Wire-end ferrules; Tube with plastic sleeve
DIN IEC 60364-5-54	Low-voltage electrical installations - Part 5-54: Selection and erection of electrical equipment - Earthing arrangements, protective conductors and protective bonding conductors (IEC 64/1610/CD)
DIN VDE 0100-729	Low-voltage electrical installations - Part 7-729: Requirements for special installations or locations - Operating or maintenance gangways (IEC 60364-7-729); German implementation HD 60364-7-729
EN 1037	Safety of machinery - Prevention of unexpected start-up; German version EN 1037
EN 55011	Industrial, scientific and medical equipment - Radio frequency disturbance characteristics - Limits and methods of measurement (IEC/CISPR 11); German version EN 55011
EN 55021	Interference to mobile radiocommunications in the presence of impulse noise - Methods of judging degradation and measures to improve performance (IEC/CISPR/D/230/FDIS); German version prEN 55021
EN 60204-1	Safety of machinery - electrical equipment of machines Part 1: General requirements (VDE 0113-1, IEC 44/709/CDV)
EN 60439-1	Low-voltage switchgear and controlgear assemblies - Part 1: Type-tested and partially type-tested assemblies (IEC 60439-1); German version EN 60439-1
EN 60529	Degrees of protection provided by enclosures (IP Code) (IEC 60529)
EN 60664-1	Insulation coordination for equipment within low-voltage systems Part 1: Principles, requirements and tests (IEC 60664-1)
EN 60721-3-1	Classification of environmental conditions - Part 3-1: Classification of groups of environmental parameters and their severities - Section 1: Storage (IEC 104/648/CD)
EN 60721-3-2	Classification of environmental conditions - Part 3: Classification of groups of environmental parameters and their severities - Section 2: Transportation and handling (IEC 104/670/CD)
EN 60721-3-3	Classification of environmental conditions - Part 3: Classification of groups of environmental parameters and their severities; section 3: Stationary use at weatherprotected locations; Amendment A2 (IEC 60721-3-3); German version EN 60721-3-3
EN 61000-2-1	Electromagnetic compatibility (EMC) - Part 2: Environment - Section 1: Description of the environment - Electromagnetic environment for low-frequency conducted disturbances and signalling in public power supply systems
EN 61000-2-4	Electromagnetic compatibility (EMC) - Part 2-4: Environment; Compatibility levels in industrial plants for low-frequency conducted disturbances (IEC 61000-2-4); German version EN 61000-2-4
EN 61000-4-2	Electromagnetic compatibility (EMC) - Part 4-2: Testing and measurement techniques - Electrostatic discharge immunity test (IEC 61000-4-2); German version EN 61000-4-2
EN 61000-4-3	Electromagnetic compatibility (EMC) - Part 4-3: Testing and measurement techniques - Radiated, radio-frequency, electromagnetic field immunity test (IEC 61000-4-3); German version EN 61000-4-3
EN 61000-4-4	Electromagnetic compatibility (EMC) - Part 4-4: Testing and measurement techniques - Electrical fast transient/burst immunity test (IEC 61000-4-4); German version EN 61000-4-4
EN 61000-4-5	Electromagnetic compatibility (EMC) - Part 4-5: Testing and measurement

EN61000-4-6	techniques - Surge immunity test (IEC 61000-4-5); German version EN 61000-4-5 Electromagnetic compatibility (EMC) - Part 4-6: Testing and measurement techniques - Immunity to conducted disturbances, induced by radio-frequency fields (IEC 61000-4-6); German version EN 61000-4-6
EN61000-4-34	Electromagnetic compatibility (EMC) - Part 4-34: Testing and measurement techniques - Voltage dips, short interruptions and voltage variations immunity tests for equipment with mains current more than 16 A per phase (IEC 61000-4-34); German version EN 61000-4-34
EN 61131-2	Programmable controllers - Part 2: Equipment requirements and tests (IEC 61131-2)
EN61373	Railway applications - Rolling stock equipment - Shock and vibration tests (IEC 61373)
EN61439-1	Low-voltage switchgear and controlgear assemblies - Part 1: General rules (IEC 121B/40/CDV); German version FprEN 61439-1
EN61508-1...7	Functional safety of electrical/electronic/programmable electronic safety-related systems – Part 1...7 (VDE 0803-1...7, IEC 61508-1...7)
EN61800-2	Adjustable speed electrical power drive systems - Part 2: General requirements- Rating specifications for low voltage adjustable frequency a.c. power drive systems (VDE 0160-102, IEC 61800-2)
EN61800-3	Speed-adjustable electrical drives. Part 3: EMC requirements and specific test methods (VDE 0160-103, IEC 61800-3)
EN61800-5-1	Adjustable speed electrical power drive systems - Part 5-1: Safety requirements - Electrical, thermal and energy (IEC 61800-5-1); German version EN 61800-5-1
EN61800-5-2	Adjustable speed electrical power drive systems - Part 5-2: Safety Requirements - Functional (IEC 22G/264/CD)
EN62061	Safety of machinery - functional safety of electrical, electronic and programmable electronic safety-related systems (VDE 0113-50, IEC 62061)
EN ISO 13849-1	Safety of machinery - safety-related parts of control systems - Part 1: General principles for design (ISO 13849-1); German version EN ISO 13849-1
UL61800-5-1	American version of the EN61800-5-1 with „National Deviations“

1 Basic Safety Instructions

The COMBICONTROL is designed and constructed in accordance with state-of-the-art technology and the recognised safety rules and regulations. However, the use of such devices may cause functional hazards for life and limb of the user or third parties, or damages to the system and other material property.

The following safety instructions have been created by the manufacturer for the area of electric drive technology. They can be supplemented by local, country- or application-specific safety instructions. This list is not exhaustive. Non-observance of the safety instructions by the customer, user or other third party leads to the loss of all resulting claims against the manufacturer.

NOTICE

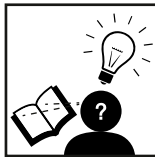

Hazards and risks through ignorance.

- ▶ Read the instructions for use !
- ▶ Observe the safety and warning instructions !
- ▶ If anything is unclear, please contact KEB Automation KG !

1.1 Target Group

This manual is written for design, project planning, servicing and commissioning experts. Qualified personnel for the purpose of this instruction manual must have the following qualifications:

- Knowledge and understanding of the safety instructions.
- Knowledge of automation technology.
- Knowledge of functional safety.
- Skills for installation and assembly of electrical equipment.
- Detection of hazards and risks of the electrical drive technology.
- Understanding of the function in the used machine.
- Knowledge of the operation of the Windows operating system.
- Knowledge of *DIN IEC 60364-5-54*.
- Knowledge of *EN 60204-1*
- Knowledge of national safety regulations (e.g. *DGUV regulation 3*).

1.2 Transport, storage and proper use

The transport is carried out by qualified persons in accordance with the environmental conditions specified in this manual. The devices shall be protected against excessive strains.



Electronic devices contain electrostatic sensitive components.

- ▶ Avoid contact.
 - ▶ Wear ESD-protective clothing.
-

Do not store the devices

- in the environment of aggressive and/or conductive liquids or gases.
- with direct sunlight.
- outside the specified environmental conditions.

1.3 Installation

⚠ DANGER



Do not operate in an explosive environment!

- ▶ The device is not intended for the use in potentially explosive environment.
-

To prevent damages to the device:

- Make sure that no components are bent and/or isolation distances are changed.
- The device must not be put into operation in case of mechanical defects. Non-compliance with the applicable standards.
- Do not allow moisture or mist to penetrate the unit.
- Avoid dust permeating the device. Allow for sufficient heat dissipation if installed in a dust-proof housing.
- Note installation position and minimum distances to surrounding elements. Do not cover the ventilation openings.
- Mounting according to the specified degree of protection.
- Make sure that no small parts fall into the device during assembly and wiring (drilling chips, screws etc.). This also applies to mechanical components, which can lose small parts during operation.
- Check the reliable fit of the device connections in order to avoid contact resistances and sparking.
- The safety instructions are to be kept!

1.4 Electrical connection

ATTENTION

In order to prevent malfunctions or unpredictable conditions, observe the following instructions:

- ▶ For any work on the device switch off the supply voltage.
- ▶ Never bridge upstream protective devices (also not for test purposes).
- ▶ Install all required covers and protective devices for operation.
- ▶ The electrical installation shall be carried out in accordance with the relevant requirements.
- ▶ Cable cross-sections and fuses must be dimensioned according to the design of the machine manufacturer. Specified minimum / maximum values may not be fallen below /exceeded.
- ▶ With existing or newly wired circuits the person installing the units or machines must ensure the EN requirements are met.
- ▶ When using components without isolated inputs/outputs, it is necessary that equipotential bonding exists between the components to be connected (e.g. by the equipotential line). Disregard can cause destruction of the components by equalizing currents.

1.5 Start-up and operation

When the device is installed in machines, start-up (i.e. commencement of the intended operation) is prohibited until it is determined that the machine complies with the machine directive; Account is to be taken of [EN 60204-1](#).

- During operation, all covers and doors shall be kept closed.
- Use only approved accessories for this device.
- Never touch terminals, busbars or cable ends.

1.6 Maintenance

The following maintenance work has to be carried out when required, but at least once per year by authorized and trained personnel. Check unit for loose screws and plugs and tighten if necessary.

- ▶ Check unit for loose screws and plugs and tighten if necessary.
- ▶ Clean the device from dirt and dust deposits. Depending on the device, pay particular attention to ventilation slots or cooling fins.
- ▶ Examine and clean extracted air filter and cooling air filter of the control cabinet.

1.7 Repair

In case of malfunction, unusual noises or smells inform a person in charge!

DANGER



Unauthorized exchange, repair and modifications!

Unpredictable malfunctions!

- ▶ The function of electronic devices can be influenced by the setting and parameterization. Never replace without knowledge of the application.
- ▶ Modification or repair is permitted only by KEB Automation KG authorized personnel.
- ▶ Only use original manufacturer parts.
- ▶ Infringement will annul the liability for resulting consequences.

1.8 Disposal

Electronic devices of the KEB Automation KG are exclusively professional devices for further industrial processing (so-called B2B devices).

Manufacturers of B2B devices are obliged to take back and recycle devices manufactured after 14.08.2018. These devices may not be disposed at the collection centres of public sector disposal organisations.



If no deviating agreement has been made between the customer and KEB or no deviating mandatory legal regulation exists, KEB products marked in this way can be returned. Company and keyword to the return point can be taken from the list below. Shipping costs are paid by the customer. Thereupon the devices will be professionally recycled and disposed.

The entry numbers are listed country-specific in the following table. The corresponding KEB return addresses can be found on our website.

Withdrawal by	WEEE-Reg.-No.	Keyword
Austria		
KEB Automation GmbH	ERA: 51976	Stichwort „Rücknahme WEEE“
France		
RÉCYLUM - Recycle point	ADEME: FR021806	Mots clés „KEB DEEE“
Germany		
KEB Automation KG	EAR: DE12653519	Stichwort „Rücknahme WEEE“
Italy		
COBAT	AEE: (IT) 19030000011216	Parola chiave „Ritiro RAEE“
Spain		
KEB Automation KG	RII-AEE 7427	Palabra clave „Retirada RAEE“
Česko		
KEB Automation KG	RETELA 09281/20 ECZ	Klíčové slovo: Zpětný odběr OEEZ

The packaging must be feed to paper and cardboard recycling.

2 System Description

The C6 E22 BOX/PANEL is an industrial, fanless Panel/Box PC based on the Intel Bay Trail SoC platform with 10W Celeron quad-core processor and 22 nm manufacturing process.

2.1 Key features

- Industrial fanless Panel / Box PC (operating temperature 0÷50°C) with Intel® Celeron® J1900 processor
- Up to 8GB DDR3 1333MHz RAM in a SODIMM module
- Wide range of 16 million colors LED backlight TFT LCD display
 - 4:3 aspect ratio: 10.4", 12.1", 15.0".
 - 5:4 aspect ratio: 17.0", 19.0".
 - 16:9 aspect ratio: 15.6", 18.5", 21.5", 24.0".
 - 16:10 aspect ratio: 10.1", 12.1".
- KEB Standards
 - Standard cut-outs for panel PCs and monitors
 - Front Panel in two different versions
 - Galvanically isolated power supply
 - Integrated micro UPS
- Supported O.S. certified by KEB:
 - Microsoft Windows Embedded Standard 7P 32 bit.
 - Microsoft Windows 10 IoT Enterprise 2019 - LTSC - Entry
 - Linux
- Slim version for reduced installation depth (SL version).
- Embedded additional cards for optional communication ports.
- Optional PCI/PCIe slot (S1 version).
- 2 Gigabit Ethernet connections
- 1 UBS 3.0 connection
- 18-32VDC isolated power supply

2.1.1 New KEB standards

2.1.1.1 Front Panels in different versions

The system can be equipped with a front panel made of full aluminum or aluminum with True-Flat technology and multi-touch.

2.1.1.2 KEB Cutout

This PC family is compatible with KEB cutout: a unique cutout for each LCD size to ensure interchangeability between different Panel PCs and monitor families and future mechanical compatibility and to quickly assist the user in updating.

2.1.1.3 Isolated power supply

Isolated Power supply with galvanic isolation to prevent:

- Common mode noise at low/medium frequencies on the power supply line
- Ground loop disturbances
- Extra-voltage caused by lightning
- Power supply with grounded positive terminal (e.g. Japan)

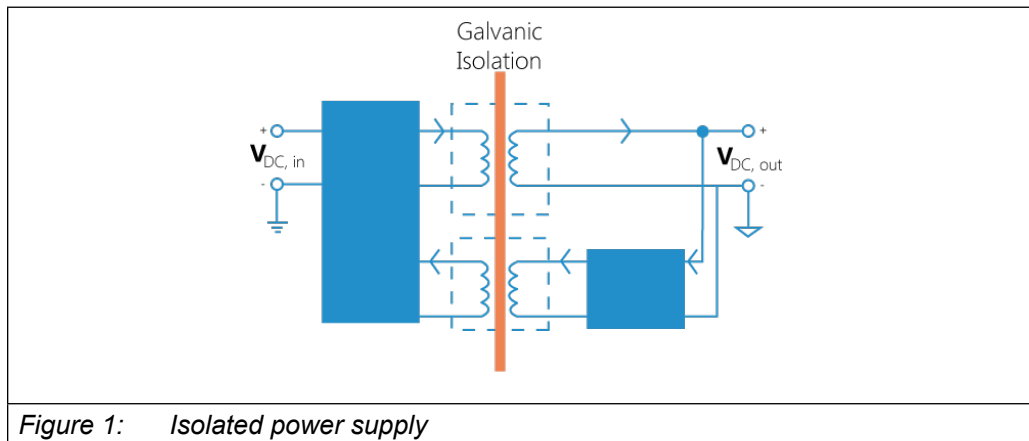

2.1.1.4 Fieldbuses

A PCI slot is available for KEB fieldbuses, inputs/outputs and NVRAM cards.

2.1.2 Optional fieldbus cards

The system can be equipped with optional fieldbus cards.





They provide additional resources for the system. one or two serial ports, one USB port, etc.

2.1.3 LCD LED backlight

LCD with LED backlight technology; the system is equipped with the new LCD generation with LED technology.

2.2 Packaging

The C6 E22 BOX/PANEL packaging consists of:

C6 E22 BOX/PANEL	
KEB Homepage	
Depending of LCD size: <ul style="list-style-type: none"> • n.10 (8+2 spare) clamps with grub screw (at 10.4" - 12.1" - 15.0" models) • n.10 (8+2 spare) clamps with grub screw (at 15.6" - 15.6" - 17.0" models) • n.12 (10+2 spare) clamps with grub screw (at 18.5" – 19.0" models) • n.16 (14+2 spare) clamps with grub screw (at 21.5" - 24.0" models) 	
n.2 hex key	
n.1 Power supply plug	
<i>Table 1: Packaging</i>	

2.3 Front Panels

The system is available with four different kinds of front panels:

- Full aluminium.
- Aluminium with True Flat technology and multi-touch (capacitive).

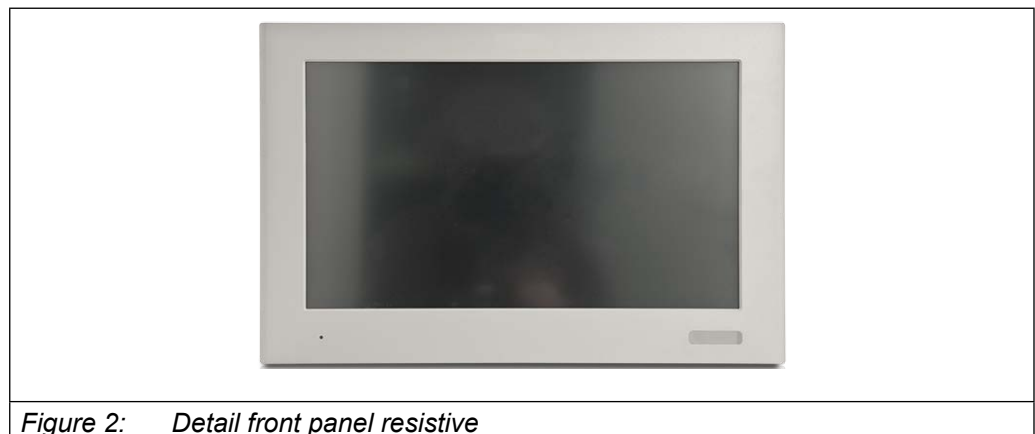

Figure 2: Detail front panel resistive



Figure 3: Detail front panel capacitive

2.3.1 Full aluminium front panel

The C6 E22 PANEL (resistive) is available in the following sizes:

- 10.1" W
- 10.4"
- 12.1"
- 12.1" W
- 15.0"
- 15.6" W
- 17.0"
- 18.5" W
- 19.0"
- 21.5" W
- 24.0" W



- | | |
|---|----------------------------|
| 1 | Full aluminium front panel |
| 2 | Touchscreen display |
| 3 | IP66 protected USB |
| 4 | On/Off/Standby/UPS LED |

Figure 4: Detail front panel resistive (the figure shows a 15.0" display as example)

The full aluminium front panel has a “step” between the front panel and the touchscreen.

	
Features	
Degrees of protection	IP66
Seal (rear side)	EPDM
Metal housing	EN AW-5754, H22 EN 485-1
<i>Table 2: Features front panels resistive</i>	

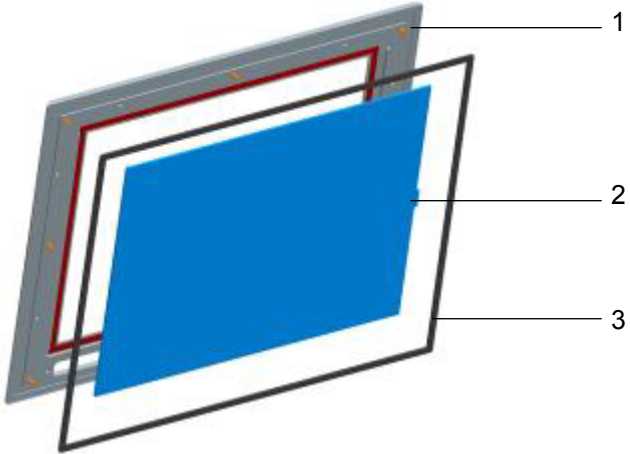
	
1	Metal housing
2	Touchscreen
3	Back seal
<i>Figure 5: Construction details</i>	

2.3.2 Capacitive front panel

The capacitive C6 E22 Panel (aluminium/glass front panel with True-Flat technology and multi-touch touchscreen) is available in the following sizes:

- 10.1" W
- 12.1" W
- 15.6" W
- 18.5" W
- 21.5" W
- 24.0" W

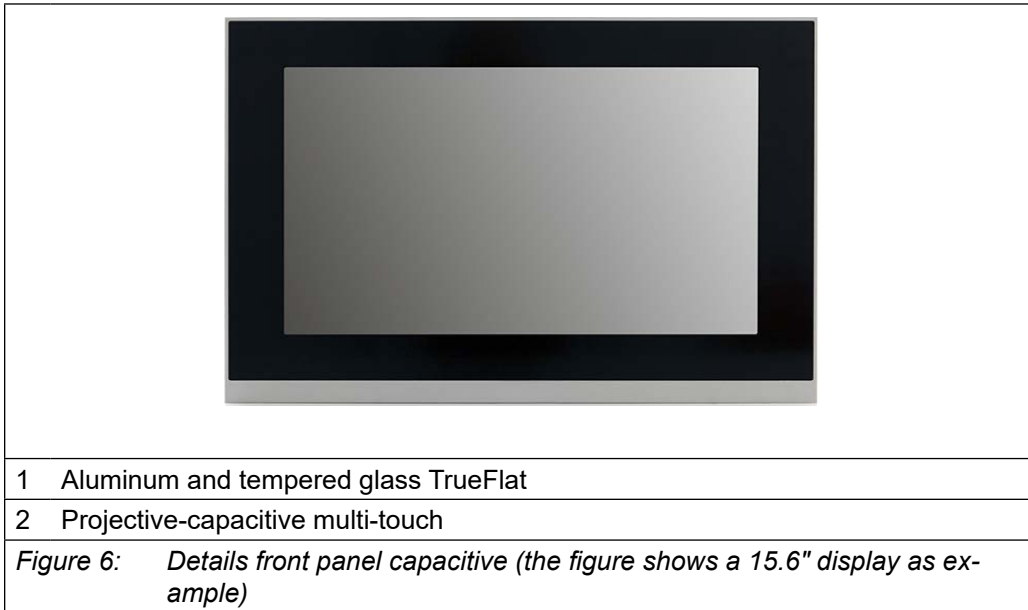

The front panels with true flat technology contain a projective capacitive multi-touch touchscreen that is operated via an USB controller in the system.

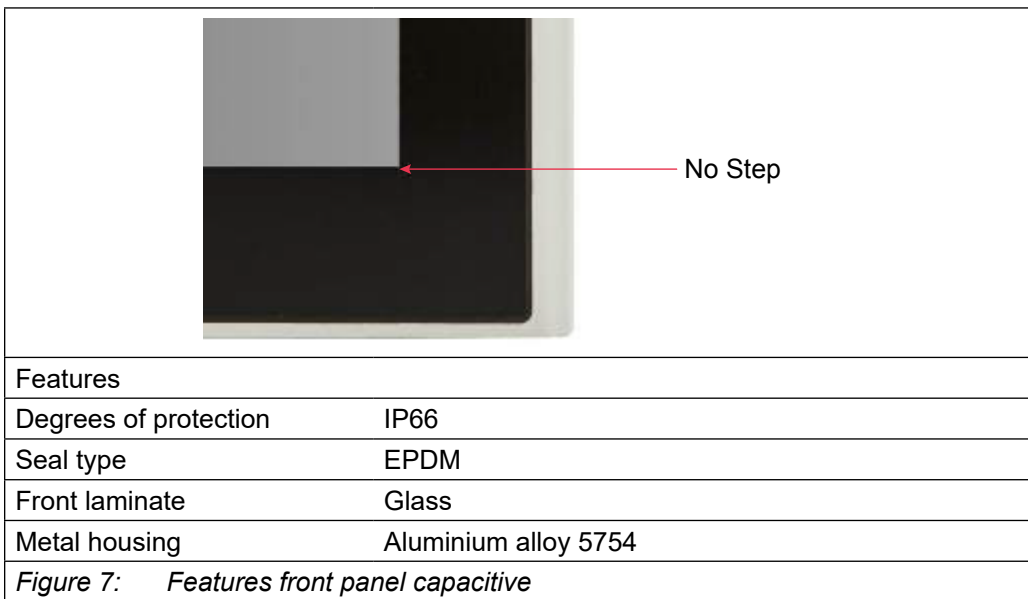

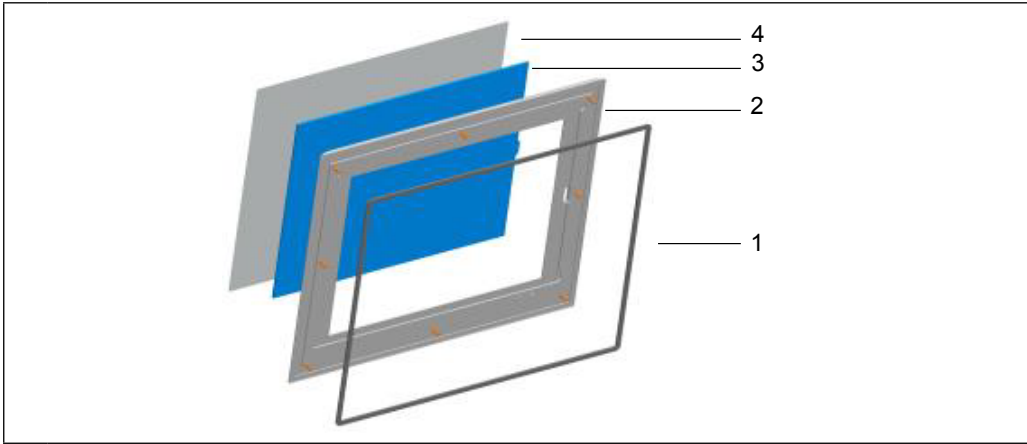

1	Back seal
2	Metal housing
3	Touchscreen
4	Glass cover
<i>Figure 8: Construction details</i>	

2.3.3 LCD aspect ratio

There are different LCD aspect ratios depending on front panel sizes:

Panel size	Aspect ratio
10.4"	4 : 3
12.1"	4 : 3
15.0"	4 : 3
17.0"	5 : 4
19.0"	5 : 4
10.1" W	16 : 10
12.1" W	16 : 10
15.6" W	16 : 9
18.5" W	16 : 9
21.5" W	16 : 9
24.0" W	16 : 9



Figure 9: 4 : 3 Example of an aspect ratio



Figure 10: 5 : 4 Example of an aspect ratio

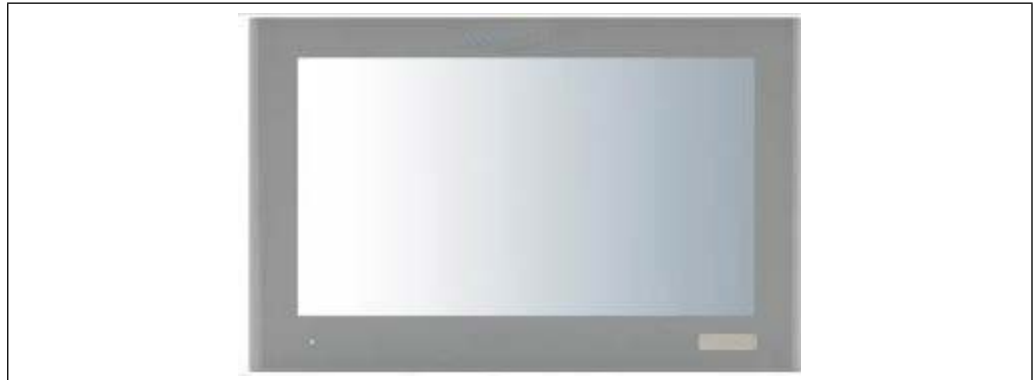

Figure 11: 16 : 9 (widescreen) Example for an aspect ratio

2.3.4 Front-USB 2.0

The USB 2.0 port on the front is protected by a non-combustible silicone cover. The protection class IP66 is achieved by the silicone cover.



Figure 12: Front USB details

2.3.4.1 Open silicone cover



- Use your finger to pull the cover to the shown position.
- Then push the cover up/down to achieve the required protection class IP66.
- Make sure that all edges fit perfectly to the hole.

Figure 13: Front USB details - Opening the silicone cover

2.4 C6 E22 Box



Figure 14: C6 E22 Box details

2.5 SL - S1 different depths / add-on slots

C6 E22 BOX/PANEL is available in two different depths, depending on the option of the expansion slots:



C6 E22 BOX/PANEL "SL" (slim form) has no PCI/PCIe slot.

Figure 15: „SL“ details

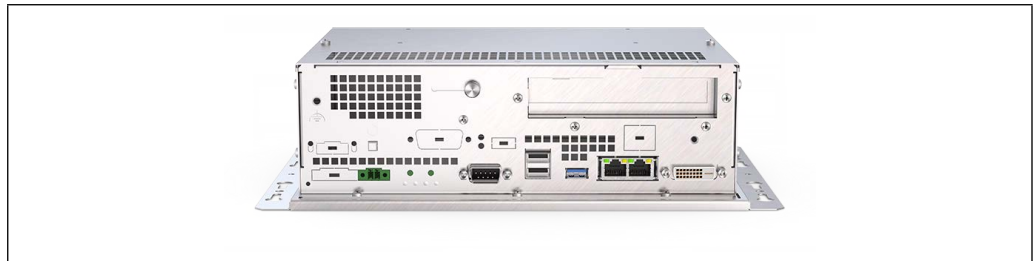

C6 E22 BOX/PANEL "S1" is equipped with an expansion slot: PCI or PCIe x1.

Figure 16: „S1“ details

Expansion slot / versions	SL	S1
Expansion slot	No expansion slot	1 circuit board from: <ul style="list-style-type: none"> • 1 x RS232/422/485 opto + 1 x USB Further circuit board: <ul style="list-style-type: none"> • 1 x LAN Gigabit
PCI / PCIe	No expansion slot	1 circuit board from: <ul style="list-style-type: none"> • NETcore X APCI • CAN RAW PCI

2.6 Rear

On the back we find the following areas:

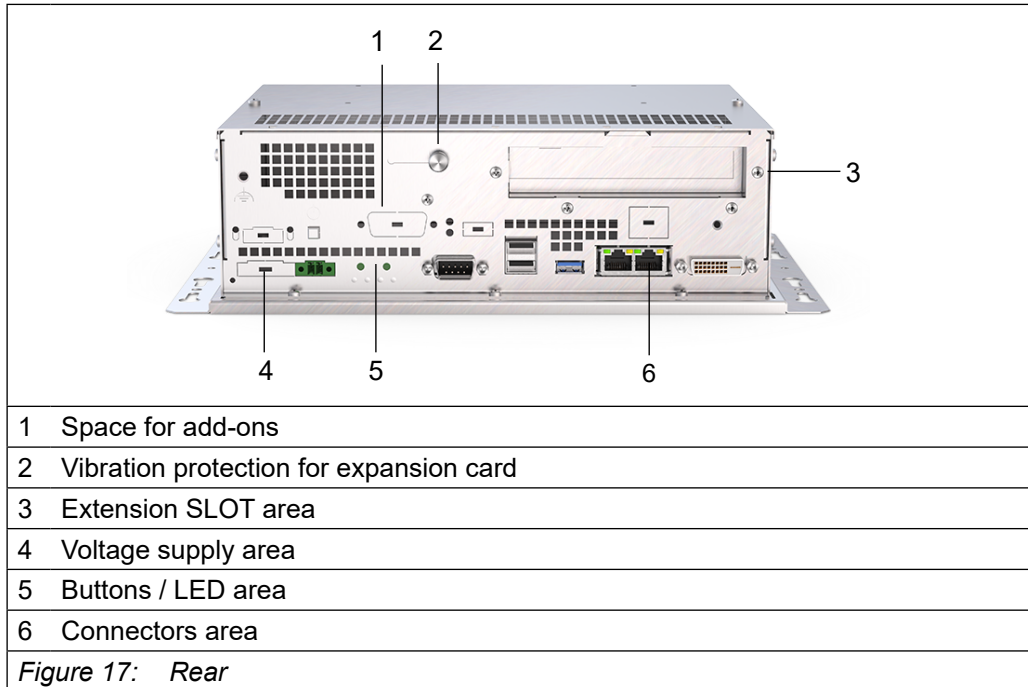

2.6.1 Expansion slot area

C6 E22 BOX/PANEL "S1" is equipped with an expansion slot in different PCI/PCIe combinations.

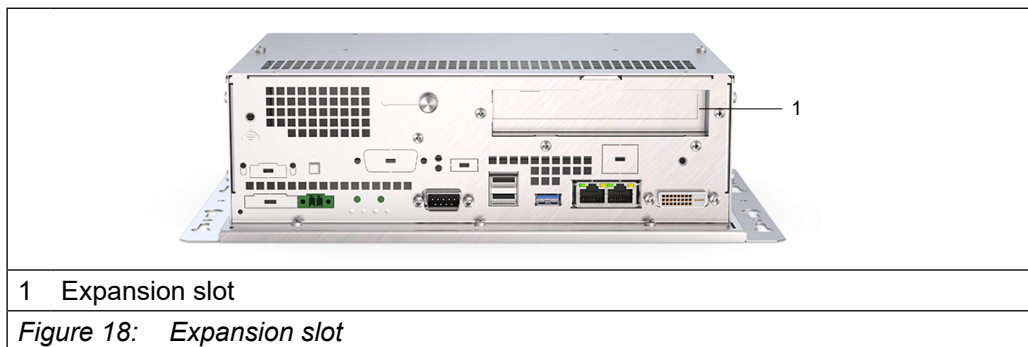

2.6.2 Voltage supply

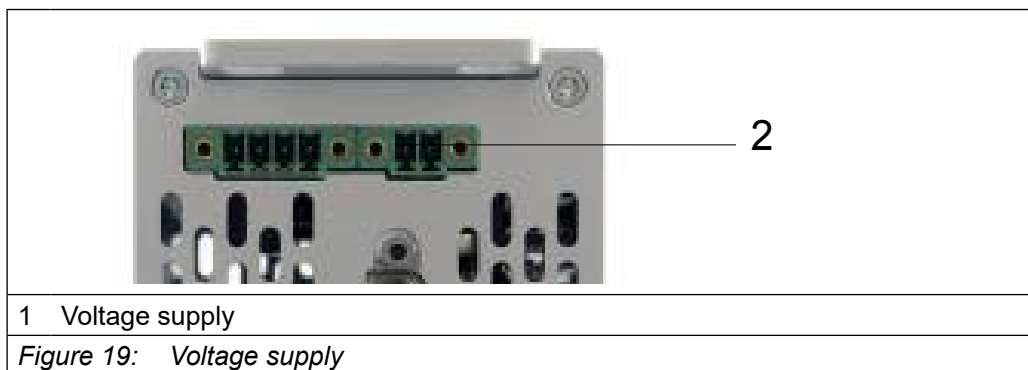

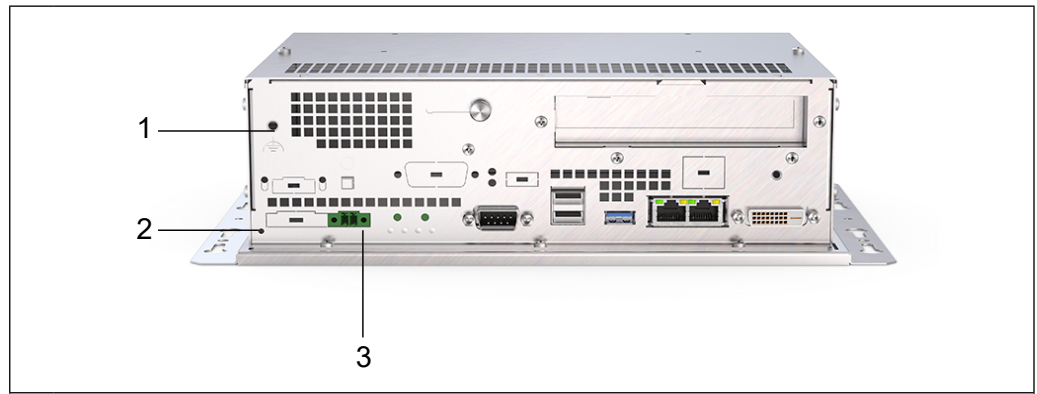

1	Earth connection screw
2	UPS status LED
3	Power DC input
<i>Figure 20: DC voltage supply</i>	

2.6.3 LED buttons

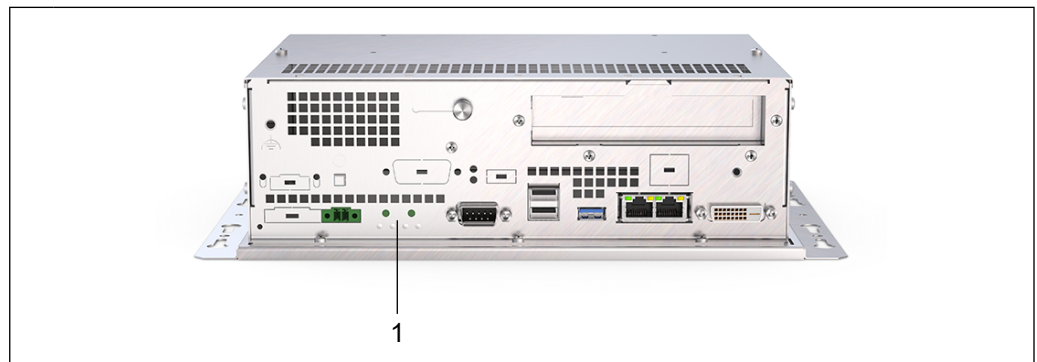

1	LED buttons
<i>Figure 21: LED buttons</i>	

The LED key area contains the following LEDs:

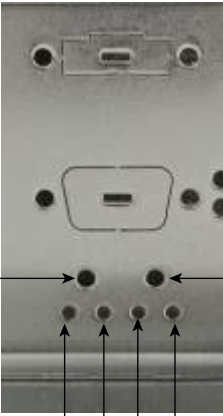

1	Reset	Acts as hardware system reset without any involvement of the operating system.
2	Over temperature / Battery fault LED	Red steady light: High temperature Red flashing: Battery is defective.
3	Watchdog LED	Reserved for future use.
4	HD LED	Yellow: Access to the hard disk.
5	On / Off / Standby	Green steady light: Device is supplied with power. Yellow on: Device is shut down. Off : Device is not switched on.
6	Watchdog reset	Reserved for future use.

Figure 22: LED buttons

2.6.4 Connectors area

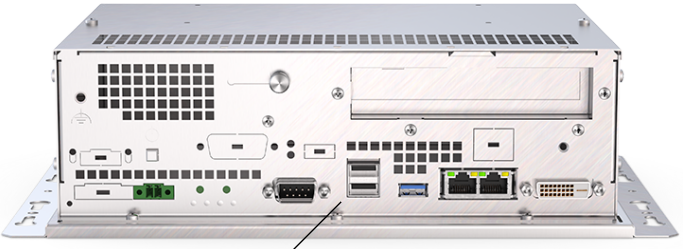

1	Connectors area
---	-----------------

Figure 23: Connectors area

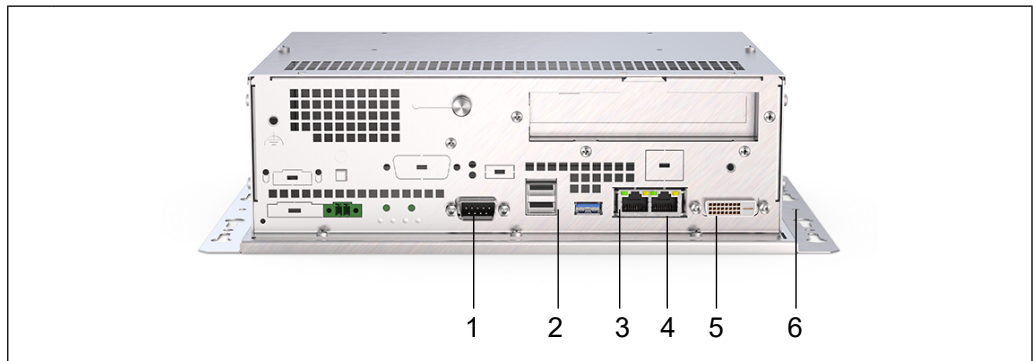

- 1 COM 1 (RS232)
- 2 2 x USB (2.0)
- 3 USB (3.0)
- 4 LAN 2 Ethernet (1000 Mbps)
- 5 LAN 1 Fieldbus
- 6 DVI-I

Figure 24: Connectors area

2.6.5 Additional area

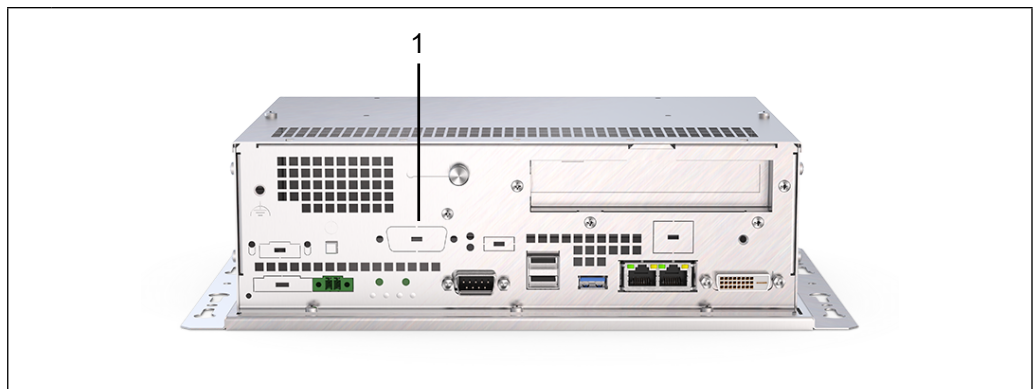



- 1 Additional area

Figure 25: Additional area

SYSTEM DESCRIPTION

The extension area provides space for the following connections:

<p>Opto-isolated COM3 and USB4</p>	
<p>Ethernet 10/100/1000 Mbps</p>	

2.6.6 Micro UPS

UPS (Uninterruptable Power Supply) devices are normally used to provide the continuity in the power supply circuitry to electronic devices where the electronics itself or the user's application hosted by the devices is critical from the possibility of a sudden loose of power. Micro UPS was developed for use in combination with CONTROL Soft PLC. The Micro UPS module is installed on an internal power supply unit.

Energy storage	4 super-capacitors 28F 2.7V connected in series.
Charging time	15s
Typical operating time	Greater than 500ms
Maintenance	None
Installation	Built-in electronics and super-capacitors
Local memory directly managed by the power supply	Non volatile 512KB MRAM for Soft PLC retain feature; real available memory 64KB for RETAIN segment + 128KB for PERSISTENT segment
System's actions taken when in UNDER_VOLTAGE	LCD is switched OFF USB power supply is switched OFF
Handling of retentive data in KEB CONTROL runtime implementation	<p>When receiving the UNDER_VOLTAGE signal the CPU starts a 20ms timer. When the timer is elapsed the system checks again the UNDER_VOLTAGE. If the signal is still active the system checks for the MICRO_UPS_VCAP_OK. If this signal is high the super-capacitors are ready and the peripherals are switched off (see previous point).</p> <p>The memory data block (128KB) is copied the MRAM memory.</p> <p>In case the super-capacitors are not ready, no data is saved to avoid possible data corruption. The data saving process can be estimated never exceeding 250ms at maximum.</p> <p>After the data copy has been completed if the UNDER_VOLTAGE signal is still active the system is turned off; if the UNDER_VOLTAGE signal is OFF the system is restarted automatically.</p> <p>In case of a shutdown command the data is saved and the system turned off. Note: Sleep mode is not supported.</p>
User's application compatibility	<p>Applications can support micro UPS "power-down event" of micro UPS APIs.</p> <p>Note: no shutdown command is sent to the OS, hence no files nor databases can be automatically closed without proper handling of the event.</p> <p>Note: If CONTROL runtime has to manage retain variables the user's "event-application" must work on a priority level greater than 10.</p> <p>Note: please contact KEB support for further details about APIs availability and use.</p>
Software utility	Micro UPS diagnostic utility (available on request).
<i>Table 3: Micro UPS data</i>	

2.6.7 Labels position

On the rear panel the following labels are present.



1 Label SL

Figure 26: Nameplate SL

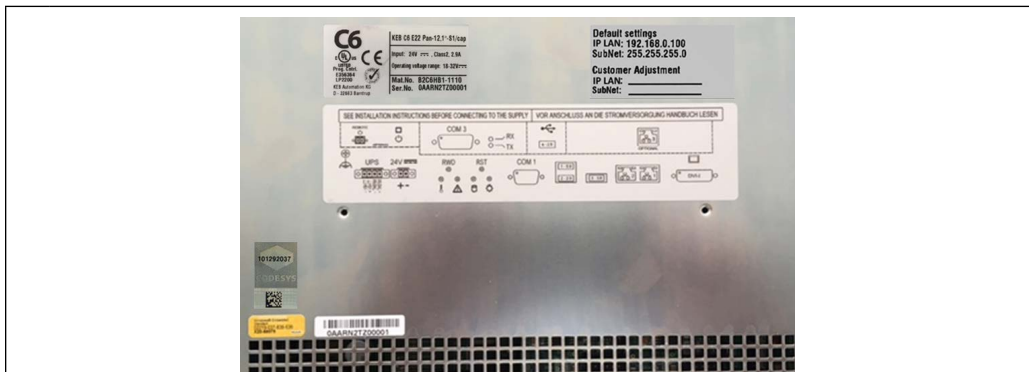

1 Label S0

Figure 27: Nameplate S0

2.6.7.1 Nameplate



2.6.7.2 Connections and label details for size SL and S1

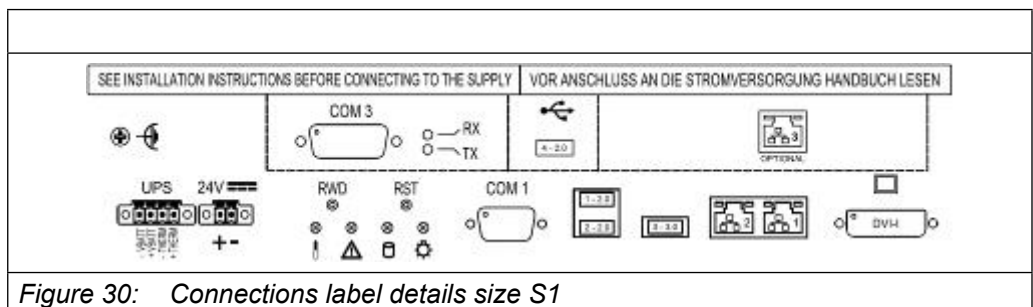
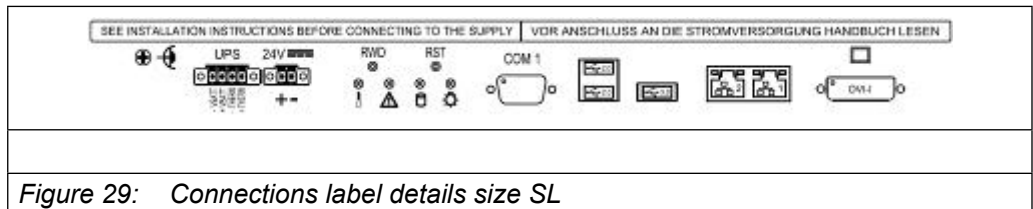

2.7 Rear view

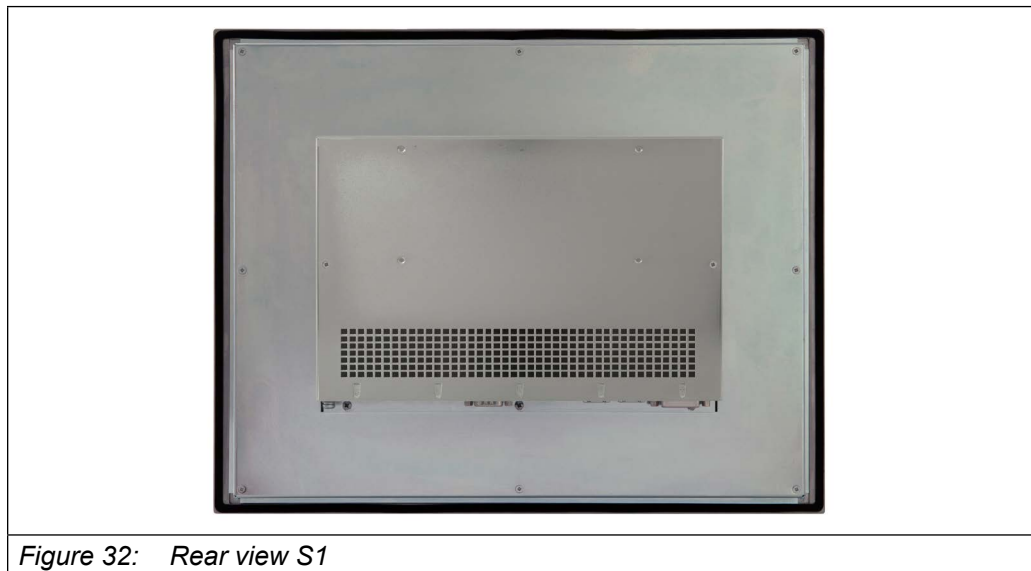
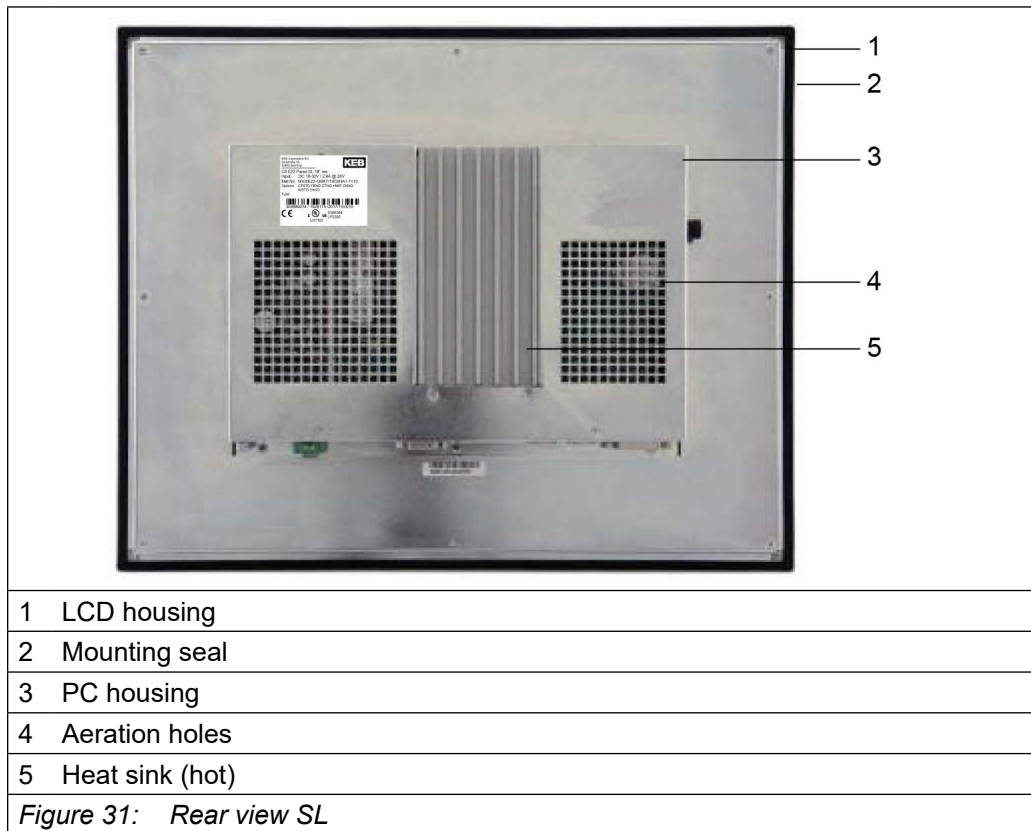

⚠ DANGER

Do not touch the heat sink!
The heat sink can be hot!

2.8 Side view



- 1 Aeration holes
- 2 Heat sink (hot)
- 3 CFast slot
- 4 Recess for fixing clamps

Figure 33: Rear view SL- side view

⚠ DANGER

Do not touch the heat sink!

The heat sink can be hot!

2.9 Touchscreen

The C6 E22 PANEL is equipped with a resistive 5-wire touchscreen and a controller integrated on the motherboard. The touchscreen may only be operated with the fingertips or with the touchscreen pen. The operator can also wear gloves, but make sure that there are no hard particles in the glove (metal, glass, etc.).

The touchscreen is available as a standard resistive 5-wire touchscreen.

	Standard touchscreen resistive	Multi Touch capacitive
C6 E22 Panel resistive	✓	/
C6 E22 Panel capacitive	/	✓

Table 4: Touchscreen

NOTICE

For example, do not use screwdrivers when using the touchscreen!

All hard parts that come into contact with the touchscreen can damage it.

2.9.1 5-wire resistive technology

Touch surface consists of PET hard foil (hardness: 3H).

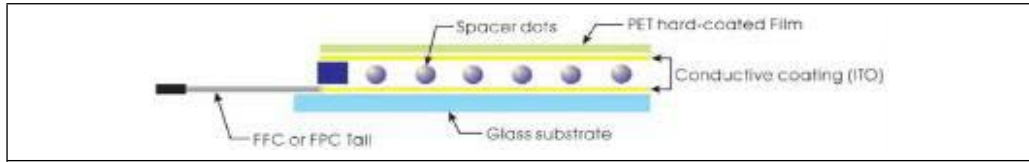

Figure 34: Standard 5-wire resistive touchscreen technology details

2.9.2 Multi-touch technology

Tempered glass and aluminium frame for the TrueFlat multi-touch front panel:

- Projected capacitive touchscreen technology (P-CAP).
- Up to 4 finger operation.
- Gesture support.



Figure 35: Details front panel capacitive

3 Installation and Connection

3.1 Preparation for installation

3.1.1 Select the mounting location

- Avoid direct sunlight exposure.
- Make sure that the C6 E22 BOX / PANEL is properly (ergonomically) accessible to the operator.
- Choose a suitable mounting height.
- Ensure that the ventilation holes are not covered.

3.2 Checking the package contents

- Check the package content for visible signs of transport damage and for completeness.
- In the case of damaged parts, contact your KEB representative. Do not install parts that were damaged during the shipment.

3.3 Checking the operating conditions

- Read carefully the standards, approvals, EMC parameters and technical specifications for operation of the device. This information is available in the following sections:
 - a) Certificates and approvals.
 - b) Electromagnetic compatibility .
- Check the mechanical and climatic ambient conditions for operation of the device. Follow the instructions for local use of the device.
- Adhere to the permissible rated voltage and the associated tolerance range:

3.4 Installation

The C6 E22 BOX/PANEL can be used for the following installation conditions:

- Mounting cabinets
- Control cabinets
- Switchboards
- Consoles

However, some important assembly instructions must be followed to avoid thermal and mechanical problems.

WARNING

For installation in control cabinets and in particular, in closed containers, make sure that the ambient temperature meets the requirements !

3.5 Avoid damage due to overheating

- All C6 E22 BOX/PANEL systems are designed for vertical position mounting.
- An inclined installation reduces the thermal convection by the device and the maximum permissible ambient temperature for the C6 E22 BOX/PANEL operation. Please contact KEB for details. The C6 E22 BOX/PANEL may otherwise be damaged and the certifications and warranty will be void.
- The ambient temperature must be between 0°C to 50°C, measured 5 cm from all openings of the system where there is air entrance.
- Provide space around the system for air recirculation and heat exchange.
- behind (z) and on the sides (x) of the PC cell leave at least 5 cm of free space; above (y) and below (y) 10cm are required. A description can be found in 3.5.1.
- Make sure that the grids on the PC part are free from objects, cables and other obstacles to the airflow.
- For example, when the system is installed in control cabinets without ventilation, it is necessary to ensure the exchange of air from outside through at least two openings:
 - a) An opening should be under the PC cell; it must be large enough to allow proper air flow from outside.
 - b) A sufficient large opening must be positioned above the PC cell to allow the hot air to flow out.
 - c) It must be checked that the measured ambient temperature (see above) corresponds to the required limit values.
- Alternatively, lateral openings are also possible, provided that their vertical dimension is long enough to ensure the necessary heat exchange.
- When the system is installed in air-conditioned control cabinets, the air-conditioning system must provide sufficient air circulation.
- When the system is installed in closed control cabinets, make sure that the maximum ambient temperature is +50°C.
- Mounting angle:
 - a) The system is intended to be mounted vertically.
 - b) For inclinations up to 20° the maximum operating temperature must be lowered by 5°C. Therefore the maximum ambient temperature is 45°C.
 - c) For other installation modes contact KEB.

3.5.1 Checking installation distances

To ensure sufficient heat transfer, the following installation distances must be observed:

- X direction (min.) 5 cm for each side.
- Y direction (min.) 10 cm for each side.
- Z direction (min.) 5 cm.



Mounting the clamps requires a space at least 20 mm on the outer perimeter of the screen frame.

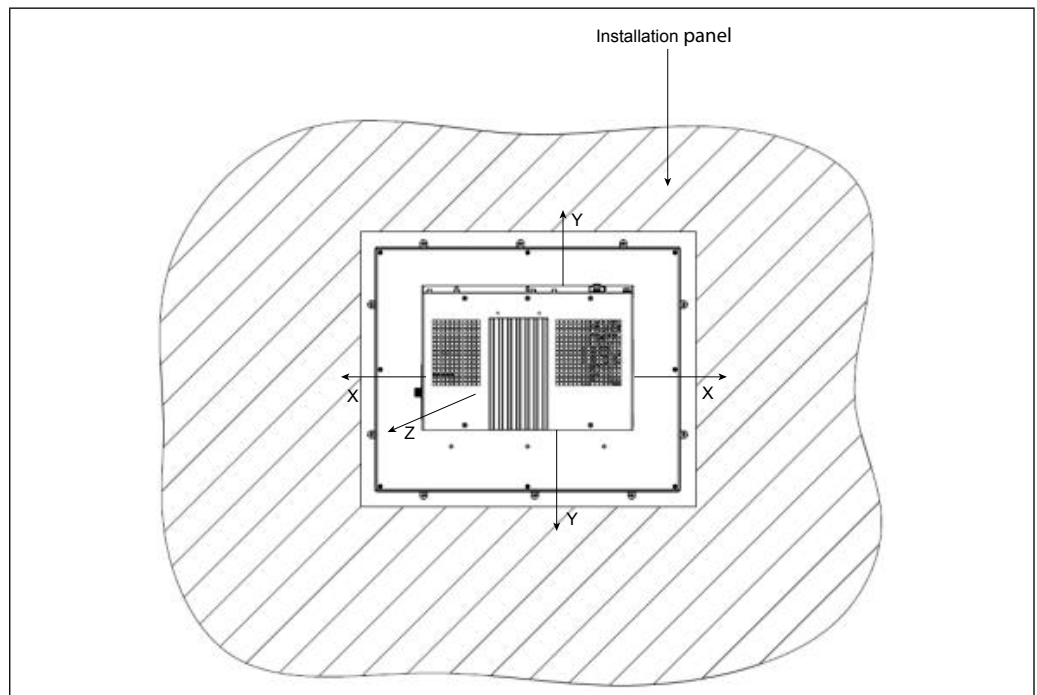

Figure 36: Mounting distances

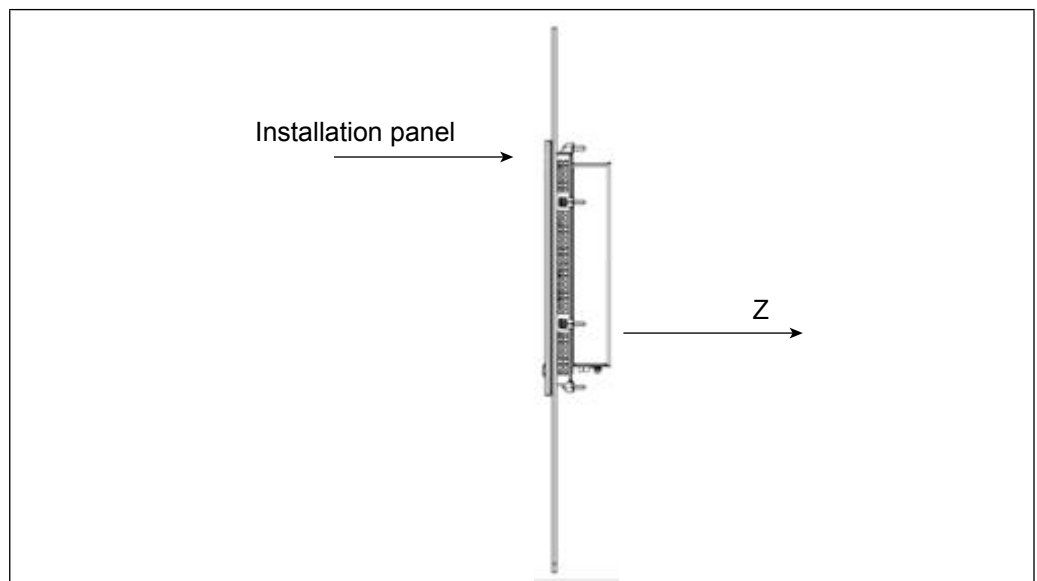
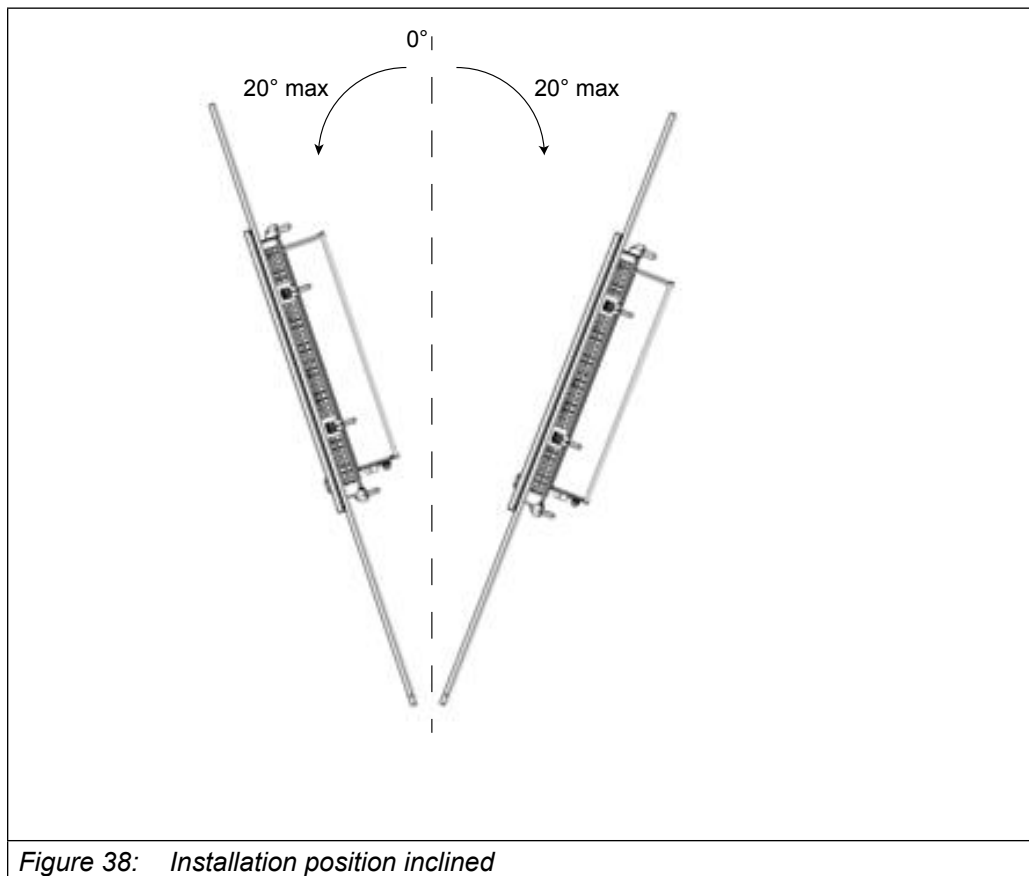

Figure 37: Mounting distances - side view



3.6 Selection of the mounting plate

In order to ensure that the system is installed correctly, the material of the mounting plates (with the mounting cut-out) must be stable.

To achieve the protection class described below, the material of this mounting plate must not be bent by the use of clamps.

3.6.1 Degree of protection

The degree of protection of the system is only guaranteed if the following conditions are met:

- The material thickness of the mounting plate (with the mounting cutout): 2 mm to 6 mm.
- Maximum deviations: ≤ 0.5 mm. This condition must be fulfilled after installation to ensure that the mounting seal functions properly.
- Permitted surface roughness in the area of the mounting seal: ≤ 120 micrometer (Rz 120).

3.7 System and cutout dimension

3.7.1 C6 E22 Panel resistive

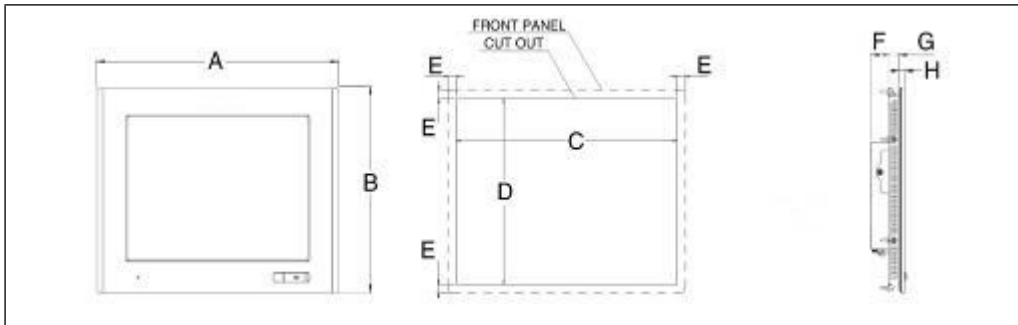

Figure 39: C6 E22 Panel resistive dimensions

LCD TFT	A	B	C	D	E	F (SL/S1)	G	H
10.1" W	293	212	277	196	8	29/77	19	5
10.4"	300	245	280	225	10	29/77	19	5
12.1"	335	270	315	250	10	29/77	19	5
12.1" W	331	234	315	218	9	29/77	21	5
15"	390	315	370	295	10	29/77	19	6
15.6" W	430	275	410	255	10	29/77	19	6
17"	455	355	435	335	10	29/77	21	6
18.5" W	500	320	480	300	10	29/77	21	6
19"	490	388	470	368	10	29/77	23	6
21.5" W	579	367	559	347	10	29/77	23	6
24" W	640	402	620	382	10	29/77	21.3	8

Table 5: C6 E22 Panel resistive dimensions

3.8 Mounting the device

3.8.1 Position of the mounting clamps

- To ensure the specified degree of frontal protection for the system, the following positions of the clamps must be observed.
- The table below shows the number and the position of the clamps for each C6 E22 Panel size.











LCD size	Clamp	Number	Clamp position
10.1"		8	
10.4"		8	
12.1"		8	
15.0"			
15.6"		10	
17.0"			
18.5"			
19.0"			
21.5"		14	
24.0"		14	

Table 7: Position of the mounting clamps

3.8.2 Tools to tighten the mounting clamps

- 1.5 mm hexagonal key provided.

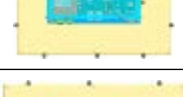
3.8.3 Procedure

- Insert the C6 E22 PANEL into the mounting cutout from the front.



Figure 43: Installation



Mounting the clamps requires a space at least 20 mm on the outer perimeter of the screen frame.

- Insert the mounting clamps into the housing of the device.



Figure 44: Installation



Figure 45: Installation



Mounting the clamps requires a space at least 20 mm on the outer perimeter of the screen frame.

- Tighten the fixing clamps with the hexagonal key (14x91x1.5 mm).

NOTICE

The max. permissible torque for the fixing clamps is 0.2 Nm.

This means: tighten the fixing clamps only until the front seal is completely compressed. Do not tighten the fixing clamps any more. If the maximum permissible torque limit is exceeded, the mechanical housing of the C6 E22 can be permanently damaged.



Figure 46: Installation

- Repeat the previous steps for all mounting clamps.

3.9 Connect C6 E22 BOX/PANEL

3.9.1 Information for the connection

- The C6 E22 BOX/PANEL must be installed in accordance with the information contained in this instruction manual.

Follow the instructions above:

- Connect the system to the grounding cable.
- Connect the power supply cable.

3.9.2 Grounding and bonding

Whenever two pieces of equipment connected to each other are far apart, it is possible that their ground connections could be at a different potential level. The shielding of the monitor cable connects the machine housing on one end and the C6 E22 BOX/PANEL housing on the other end can therefore be subject to a high current circulation capable of destroying the interface. To overcome this hazard such current must be steered away from the interface. To achieve this goal the following methods can be used:

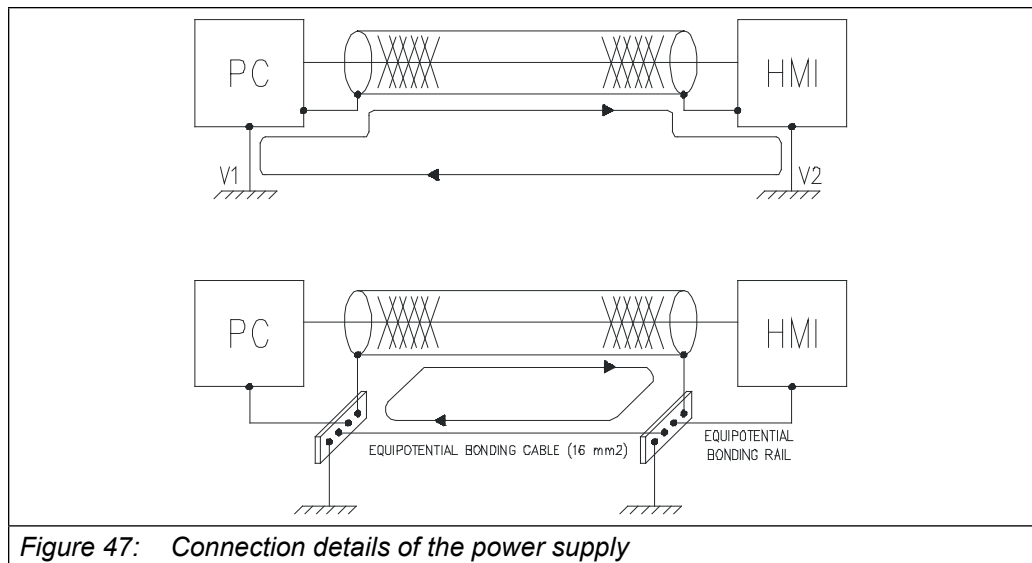

Figure 47: Connection details of the power supply

1. Use an equipotential bonding cable (16mm²) to connect the equipment ground to the C6 E22 BOX/PANEL ground.
2. Connect the data cable screens to the equipotential bonding rail on both sides before connecting the cable to the interfaces.

- Fix the earth connection screw on the back.

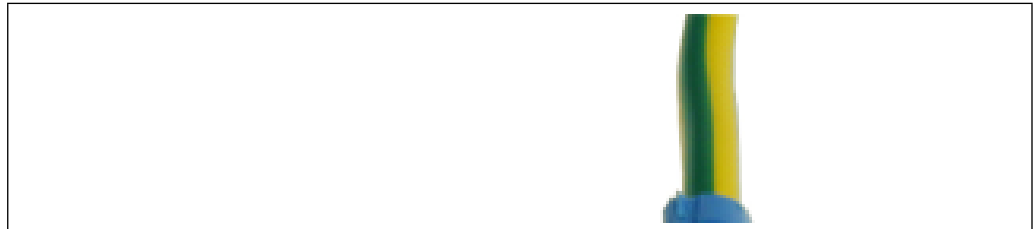
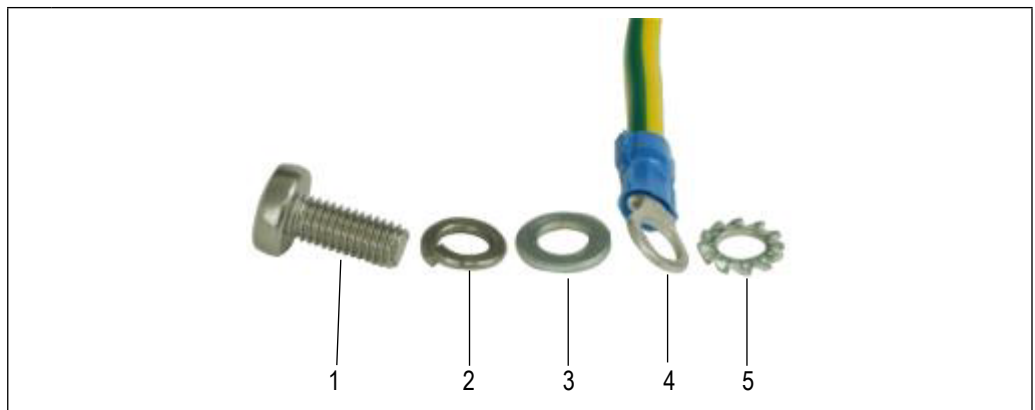

Figure 48: Power supply connection detail

- Insert the earthing eyelet terminal between the washers in the following sequence:



1	Screw
2	Spring washer
3	Plain washer
4	Eyelet terminal
5	Toothed washer

Figure 49: Power supply connection detail

3.9.3 Galvanic isolation of the power supply

The C6 E22 BOX/PANEL power supply is galvanically isolated which means its output is electrically separated from its input. This function has several advantages:

- Increases the noise immunity of the system.
- Avoids input short circuits in systems with the power supply grounded.
- Breaks ground loops which may cause interferences in the video signals.

3.9.4 Power supply connection

The device may only be connected to a 24 VDC (18V±32V) power supply that meets the requirements of a safety extra-low voltage (SELV) according to IEC/EN/DIN EN/UL60950-1.

- Remove the two poles plug connector from the system.
- Connect the positive and the negative pole (also refer to the label on the back of the system) to their respective terminals of the two pole plug connector. Use wires with a cross-section of 1.5 mm² (AWG16). Always check that the voltage drop along the supply wiring is not excessive and the input voltage remains above the minimum required (18V) in the worst load condition.
- Connect the ground cables (PE) to the earthing points.



Figure 50: C6 E22 BOX/PANEL Detail

3.9.5 Power connection assembly

The system is equipped with a connector cup to be installed on the two poles power connector. To properly assemble the connector please follow these instructions:



Figure 51: Power connector assembly

- Insert the cable tie in the cup as shown in the picture.



Figure 52: Power connector assembly

- Slide the cable tie as shown in the picture.

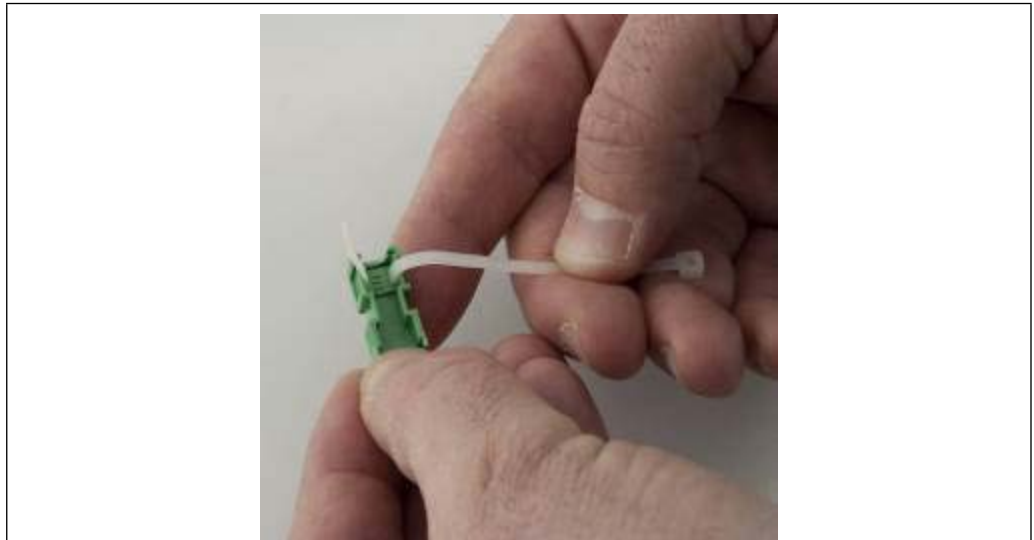

Figure 53: Power connector assembly

- Place the two poles plug connector in the cup as shown in the picture.

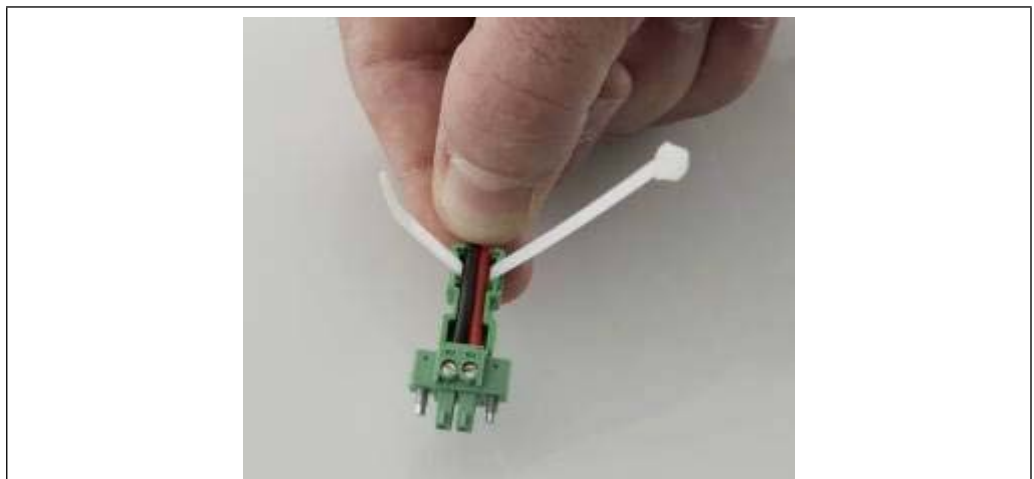

Figure 54: Power connector assembly

- Tighten the cable tie.

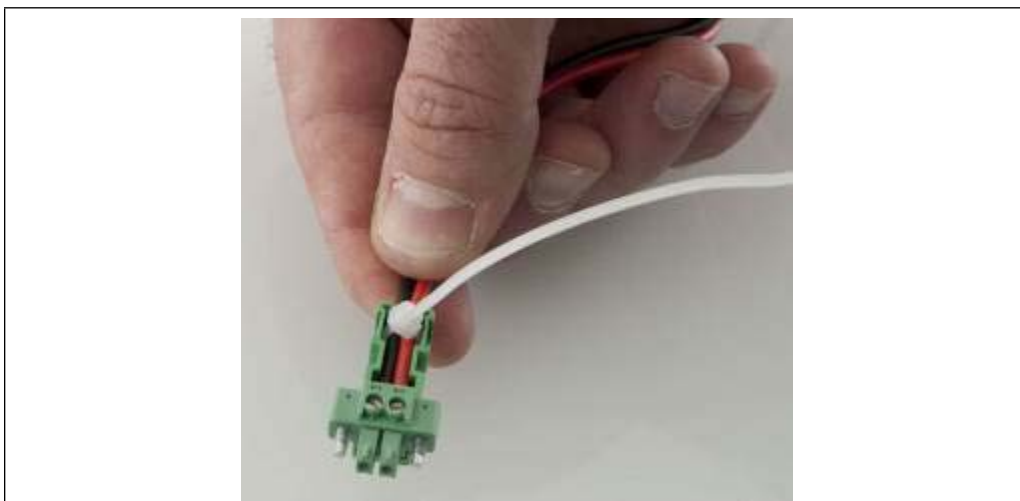

Figure 55: Cup installation

- Cut the excess part.

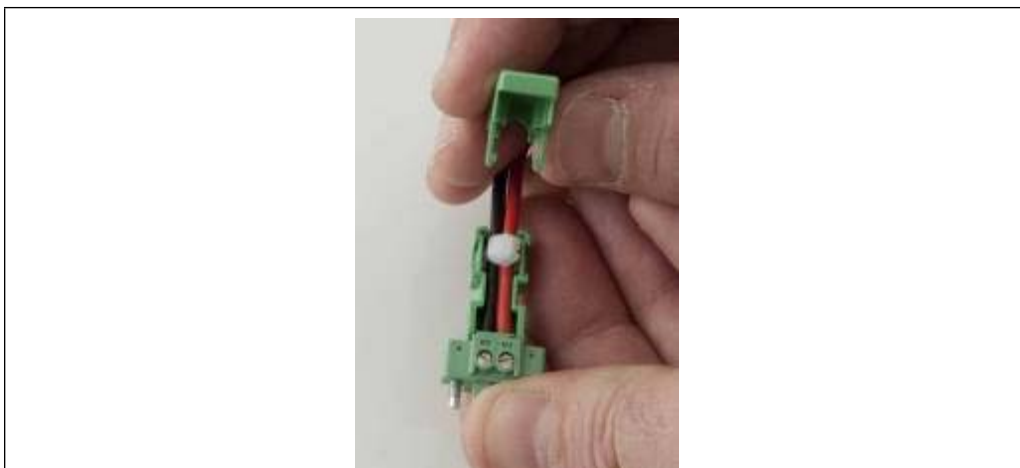

Figure 56: Cup installation

- Insert the white label and close the cup as shown in the picture.



Figure 57: Cup installation

- Example of a correctly installed cup.

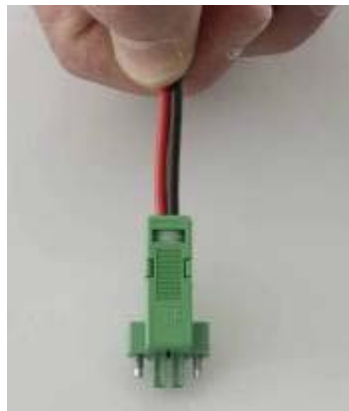
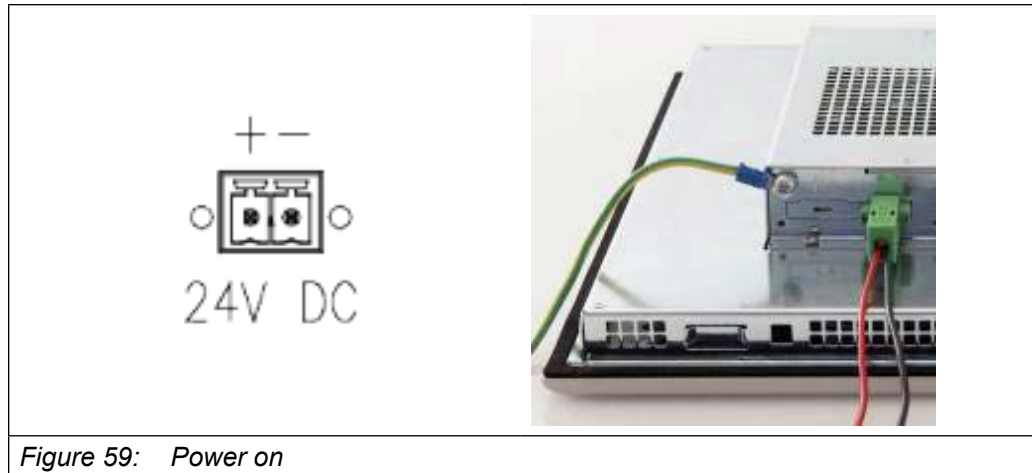

Figure 58: Power connector assembly

3.9.6 Power on

- Connect the power supply cable to the C6 E22 BOX/PANEL.
- Attach the power connector as shown in the figure. Use the screws on the side of the power connector for fastening.



The system starts bootstrapping.

- On/Off/Standby LED on the front lights up.

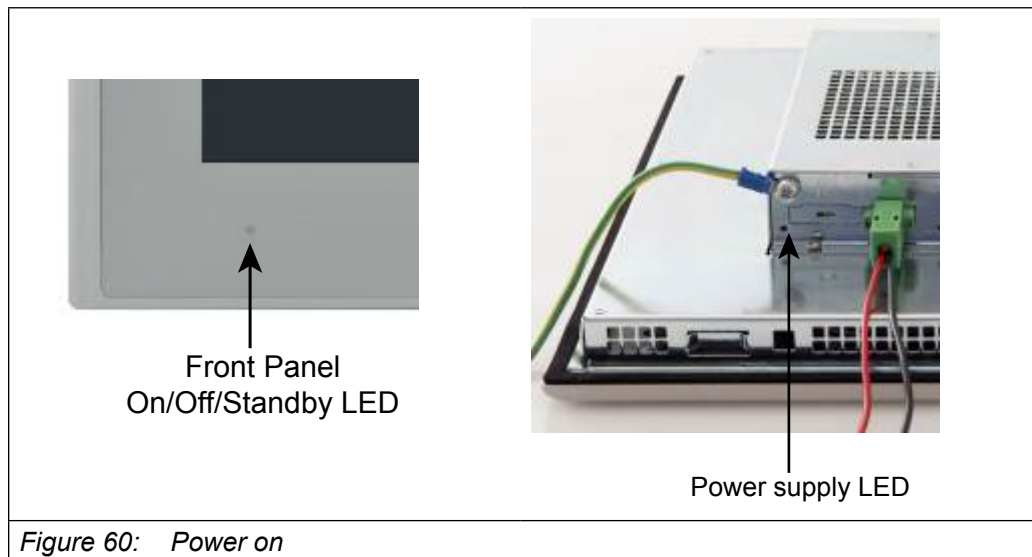

- The yellow LED lights up for less than one second. Afterwards a permanent green LED indicates normal operation.

3.9.6.1 LED power supply

System power status	Green	Yellow	Notes
ON	ON	OFF	Power is taken from the input power supply
OFF	OFF	OFF	No power supply
Battery fault	OFF	ON	Check the battery connection
UPS active	Blinking	OFF	The power supply is provided by rechargeable batteries

Table 8: LED power supply

3.9.6.2 Front On/Off/Standby LED

System power status	Green	Yellow	Notes
OFF	OFF	OFF	The system is not powered.
Suspend To Disk	OFF	ON	The power supply can be switched off. The shutdown of the operating system is finished.
Full On or Suspend To RAM	ON	OFF	The system core is full or at a low power level and stores current session information in memory.
UPS	Blinking	OFF	System core is full. The main power is missing and the UPS supplies the system with power.

Table 9: Front On/Off/Standby LED

4 Operating Systems

4.1 KEB Windows Images (Windows Embedded Standard 7 / Windows 10)

4.1.1 Introduction

KEB has created a “Windows Embedded Standard 7” (WES7) / Windows 10 (Win10) image for C6 E22 / C6 P3x with special features that support the work with the devices.

4.1.2 User Accounts

There are two user accounts implemented in the KEB image: AutoLogon and remote. The following table shows the details for the accounts:

Account	AutoLogon	remote
Administrator	Yes	Yes
Password	No	remote
Remote access	Not possible	Yes
Intention	Automatic logon after reboot	Remote Desktop connection
<i>Table 10: User Accounts</i>		

NOTICE

The default password for “remote” account should be changed to an individual password for security reasons.

The AutoLogon should be continuously used as the standard logon, because only a logon without password reaches immediate start of Control and HMI application after boot of the device, which is generally the desired behavior for a machine control device. Since in WES7 / Win10 a remote logon as account without password is not possible, there is no security risk regarding the missing password for AutoLogon.

Of course own user accounts can be created, but this is not the default approach destined by KEB.

4.1.3 Ethernet Address

The C6 E22 / C6 P3x are configured to obtain an IP address from a DHCP server. If no DHCP server is available in the network the device uses the IP address 192.168.0.100. Thus it is also possible to connect directly to the device without a network infrastructure with a development PC by configuring the Ethernet adapter of the development PC with another 192.168.0.xxx address.



Switching to the IP address 192.168.0.100 by the device can take several minutes because the device waits this time for the possible DHCP address assignment.

4.1.4 Usage of storage memories

The C6 E22 C6 P3x is delivered with two hard disk drives, a SSD and a CFast card. In Win7 Image the SSD is divided into two volumes C:\ and D:\ of its half size each. On C:\ the Operating System and the runtimes (Control, HMI, Connect) are located. D:\ is reserved for future use.

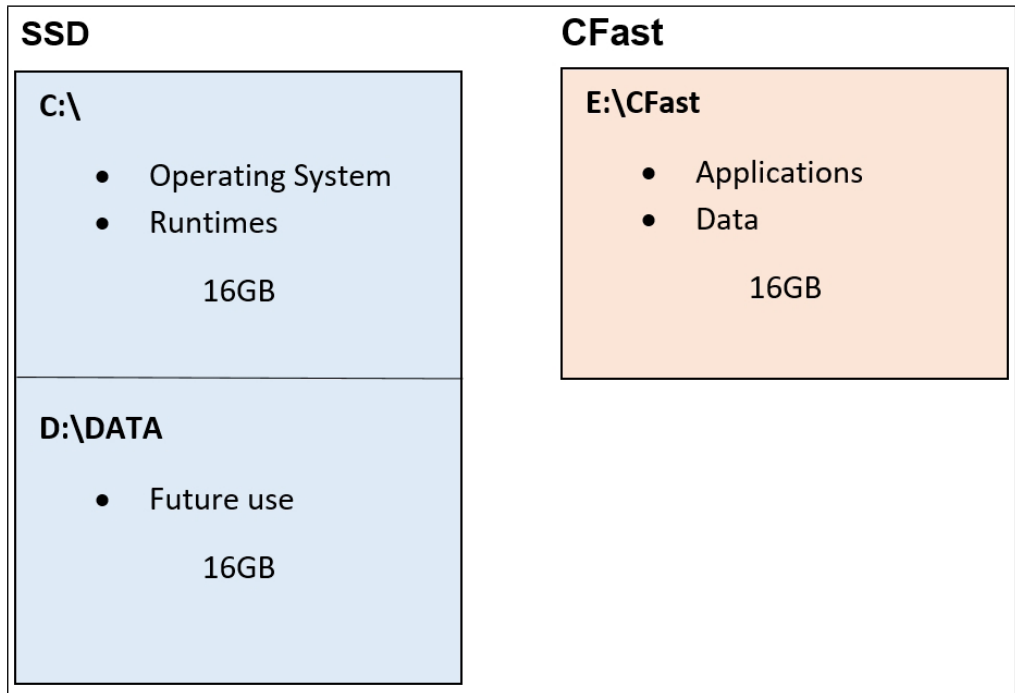

The SSD is not divided in Win10.

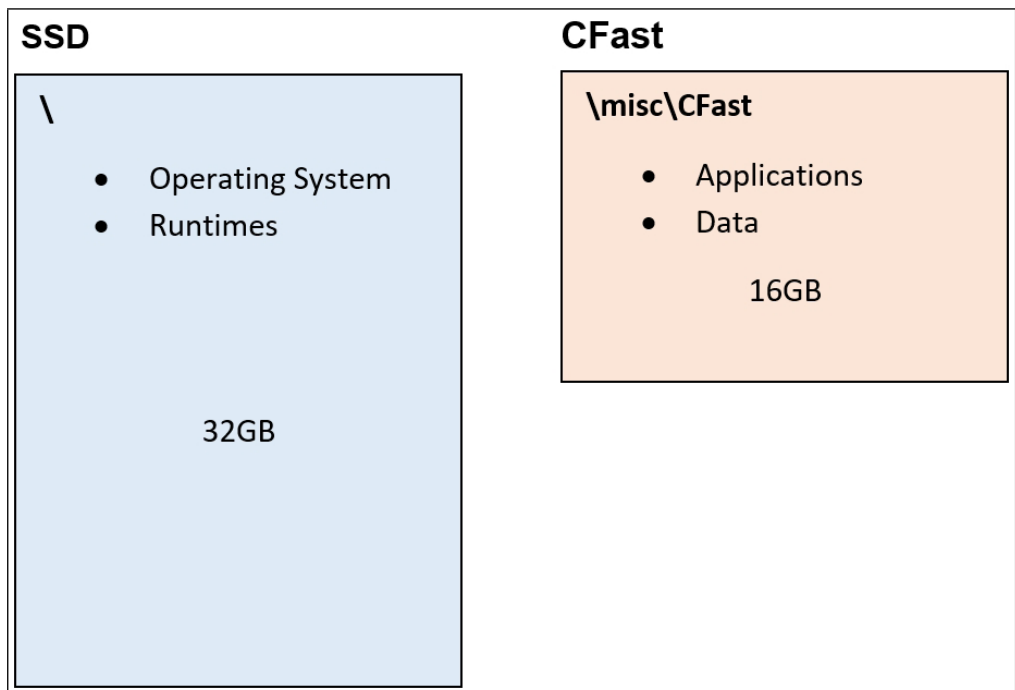

The applications and data are separated and located on the CFast (E:\). Since the CFast is easy to remove, the applications can easily be transmitted to an exchange device.

4.1.5 Firewall

The Windows-firewall is enabled in the delivery state. This protects the device against many types of network based attacks. KEB has configured the Windows firewall that all foreseen network connections are allowed. The Control runtime and the HMI runtime are allowed to open all network ports because for both programs a rule in the firewall exists.



This is the recommended way to configure a firewall: allow (trusted) programs to open any port instead of allow ports to be opened by any program.

However, in case of assumption that the firewall blocks desired network communication there is an easy way to disable the firewall completely for testing. On the desktop you find a "FirewallDisable" shortcut which does this and also a shortcut for enabling the firewall again.

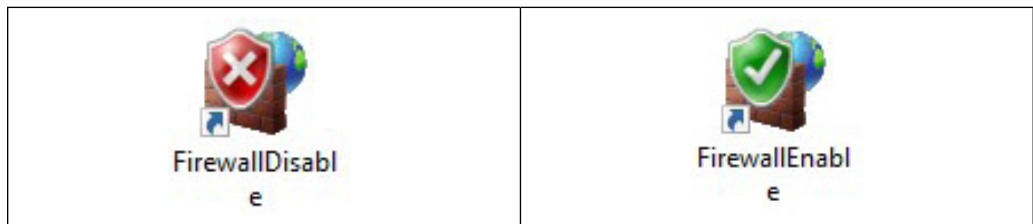

The commands need "elevated rights". Confirm the question from the User Account Control with "Yes":

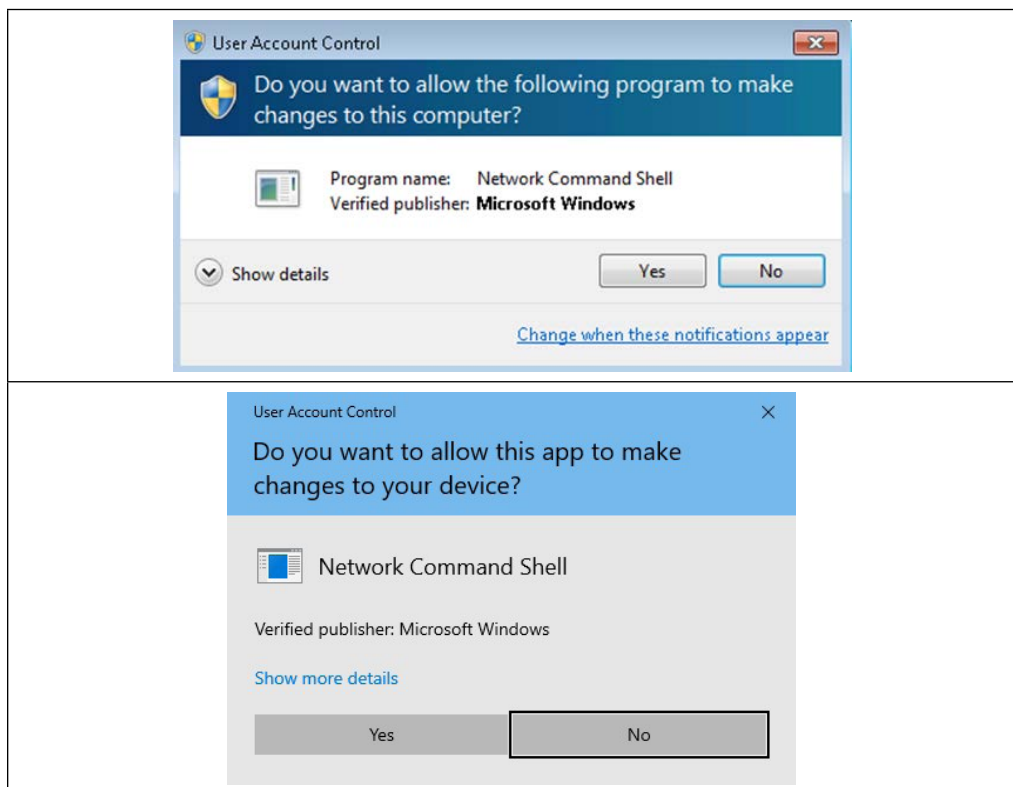

NOTICE

It is not recommend to disable the firewall permanently. If the test with disabled firewall confirms that the desired network communication is possible, an appropriate rule should be implemented in the firewall configuration (preferred for a program instead of a port) and the firewall should be activated again. How to implement firewall rules can be referred on the appropriate web sites from Microsoft for Windows 7 / Windows 10.

4.1.6 eGalax Touch Driver

The eGalax driver is installed on all C6 E22 / P3x devices, except the panel devices with capacitive touch. This driver supports all touch controllers of C6 E22 / P3x panel devices and external C6 monitors from KEB. But it does not support Multi-Touch functionality. Multi-Touch functionality is only possible with capacitive panel devices and requires the WES7/Win10 internal Microsoft Touch driver.

This driver, in turn, is not able to operate resistive touch displays. The following table gives an overview:

	Resistive	Capacitive
Single Touch	eGalax driver	eGalax driver
Multi-Touch	Not possible	Microsoft touch driver

The appropriate driver is installed on C6 E22 / C6 P3x panel devices. For Box and Bookmount devices, this preselection could not be done at the factory because the used external C6 monitor is not known at the time of production. Thus the eGalax driver is installed on those devices. If they are used in combination with capacitive C6 monitors (and Multi Touch functionality is desired at all) it is necessary to uninstall the eGalax driver. The Microsoft touch driver becomes active than automatically after 2 reboots. To uninstall the eGalax driver you find an “eGalaxUninstall” desktop shortcut which does this and also a shortcut for installing the eGalax again.

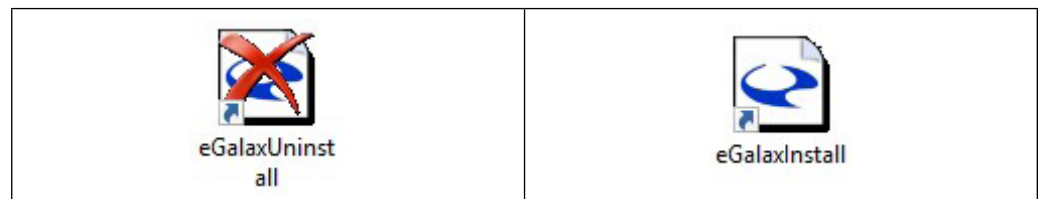

Since the used touch technology is predetermined for C6 E22 / C6 P3x panel devices, the desktop shortcuts are not placed on the desktop on these devices.

The commands need “elevated rights”, thus please confirm the question from the user account control with “Yes”:

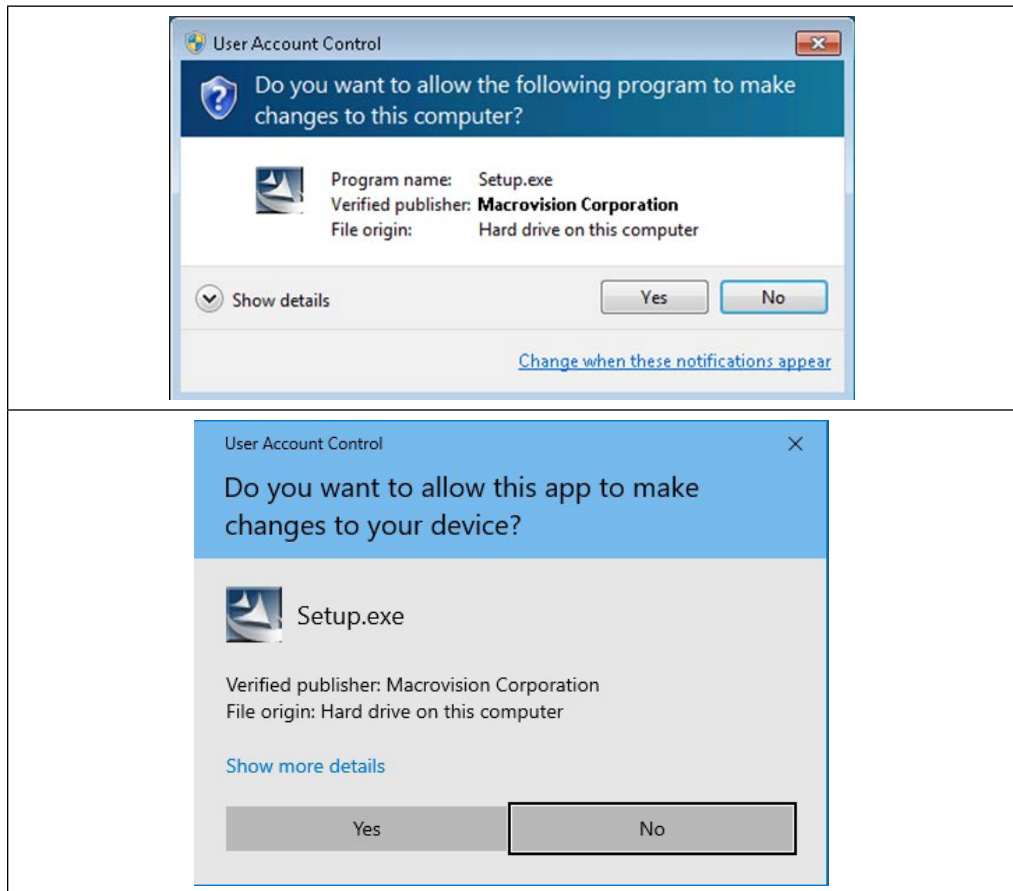

Reboot the device twice finish the switch to the Microsoft driver.

4.2 Windows Updates

The Windows Update service is disabled by KEB because it influences the realtime behavior of the system.

KEB recommends to enable the Enhanced Write Filter (EWF) for volume C:\ to protect the operating system against any change and damage in productive phase, thus windows updates would be discarded anyway.



Necessity of windows updates for security reasons depends on an overall concept of security for the field of application and is the responsibility of the user of this device.

4.3 EWF implementation in the Windows Embedded Standard 7 images

All the KEB Windows Embedded Standard 7 images have a built-in support for Enhanced Write Filter (EWF).

EWF protects a volume from write access.

Its two major components are the EWF overlay and the EWF volume:

- EWF Overlay: EWF protects the contents of a volume by redirecting all write operations to another storage location. This location is called an overlay. An EWF overlay can be in RAM, or on another disk partition. An overlay is conceptually similar to

a transparency overlay on an overhead projector. Any change that is made to the overlay affects the picture as it is seen in the aggregate, but if the overlay is removed, the underlying picture remains unchanged.

- EWF volume: In addition to the EWF overlay, an EWF volume is created on the media in unpartitioned disk space. This EWF volume stores configuration information about all of the EWF-protected volumes on the device, including the number and sizes of protected volumes and overlay levels. Only one EWF volume is created on your device, regardless of how many disks are in the system. If your media does not support multiple partitions, you can save the EWF configuration information in the system's registry (RAM Reg Mode, KEB's choice)

EWF was configured by KEB with the RAM Reg Mode to protect the C: volume. So, the overlay is in RAM and the EWF volume location is in system registry.

If EWF is activated, each write operation for C: is redirected to an overlay in the RAM memory. no data will be permananetly stored into C.

In case of a reboot or of a system restart after a power failure, the overlay will be reset and all the data written in the previous session will be lost. The view of volume C: will be the same after each restart.

If no persistent volume C: is available, at least one other volume (a separate D: partition, another storage device, a network share) must be created that contains persistent data for the application.

This second volume will not be protected from power failures, but will not contain information that is vital for system booting.

On KEB Windows Embedded Standard 7 images, EWF is disabled by default at shipment and it must be enabled by the customer, in case it is needed.

4.4 KEB Write Filter Manager (KEB-WF_MGR)

4.4.1 Introduction

KEB Write Filter Manager bases on the Enhanced Write Filter (EWF) from Microsoft for Windows Embededd Standard 7(WES7).

4.4.2 How EWF works

EWF protects a volume from write access. This is realized by an EWF overlay: EWF protects the contents of a volume by redirecting all write operations to another storage location. This location is called an overlay. An EWF overlay can be in RAM, or on another disk partition. An overlay is conceptually similar to a transparency overlay on an overhead projector. Any change that is made to the overlay affects the picture as it is seen in the aggregate, but if the overlay is removed, the underlying picture remains unchanged.

When EWF is enabled for a volume, every write operation to that volume will be redirected to an overlay in RAM and no data will be persistently stored into the volume. In case of a reboot or of a system restart after a power failure, the overlay will be reset and all the data written in the previous session will be lost. The view of the volume will be the same, after every reboot. Thus the content of the volume is protected by any damage which can be caused by power fails otherwise.

4.4.3 Protectable volumes

Volume	Protectable	Intention
C:\	Yes	Holds the operating system (including the registry) and the installed programs. Should be protected to ensure that the system never becomes unbootable.
D:\DATA	No	For free data storage, future use
E:\CFAST	Yes	Holds the Control and HMI applications. Should be protected to ensure that the applications never become invalid.

Table 11: Volume protection

4.4.4 KEB EWF configuration

On KEB devices RAM overlay is used and the EWF configuration is stored in the registry of the WES7 operating system, which resides with the operating system on volume C:\. This implies that changes to the EWF configuration are only possible if the EWF for volume C:\ is disabled or the changes to C:\ will be committed. Otherwise they will be discarded after a reboot. The following table shows the dependencies between the volumes:

		Registry Drive (holds the registry): C:\									
		Status		EWF enabled				EWF disabled			
		Boot Command	(Boot) Command	ENABLE	DISABLE	COMMIT	NO_CMD	ENABLE	DISABLE	COMMIT	NO_CMD
Dependent Drive: e.g. E:\	EWF enabled	Enable	in this state	for drive C:	not available in this state		state	for drive C:	in this state		
		Disable			x	-	x				
		Commit			x	x	x				
		Commit and Disable live			x	x ¹⁾	x				
	EWF disabled	Enable	not available	not available	x	-	x	not available	not available	x	
		Disable	not available	not available	not available in this state		state	not available	not available		
		Commit			not available in this state		state				
		Commit and Disable live			not available in this state		state				

x possible
 - not possible
 x¹⁾ possible, but EWF enabled again after reboot



These dependencies are handled by the KEB_WF_Mgr internally. Therefore it is not necessary to understand this table completely or to use it as a reference when using the EWF. But keep in mind that there are dependencies because some internal operations of the KEB_WF_Mgr has to be confirmed by the user.

4.4.5 Delivery state of EWF on KEB devices

On KEB Windows Embedded Standard 7 image, EWF is disabled by default at shipment because some settings has to be made on the drive respective in the registry by the user (e.g. IP address setting).

Every time WES7 starts with EWF disabled for volume C:\ the user is reminded to enable the EWF by the following message box:

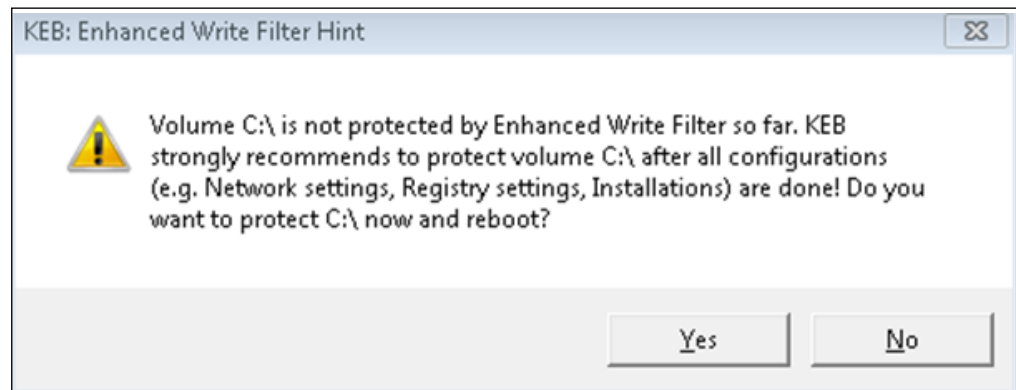

After all settings to the registry are done you can directly activate the EWF for volume C:\ by clicking 'Yes'. The device will reboot immediately and the EWF is enabled for volume C:\.

If you click "No" the message box is closed but will be appear again after the next reboot.

Please note that the volume E:\ which holds the application data is not protectable by this way.

4.4.6 Using KEB_WF_Mgr

To disable EWF or to enable it for other volumes, KEB_WF_Mgr should be used (the use of the command line program "ewfmgr" from Microsoft is not recommended by KEB).

Start the KEB_WF_Mgr by double-click the icon on the desktop:



Then the desktop link will start the program which resides in the path „C:\Program Files\KEB\IPCTools“.

The program needs "elevated rights". Please confirm the question from the user account control with "Yes":

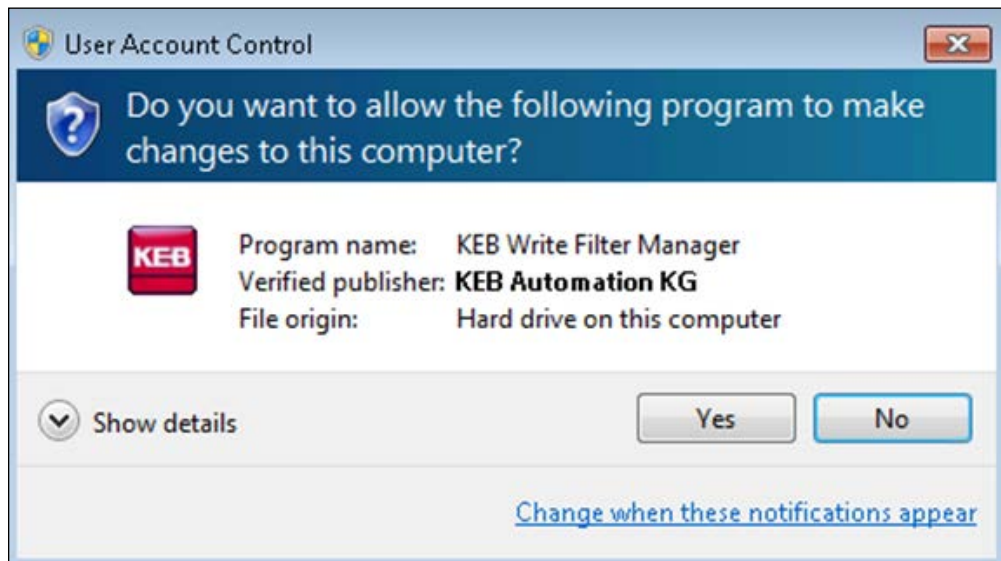

The program's GUI appears with volume C:\ (provided that EWF for volume C:\ has already been activated before).

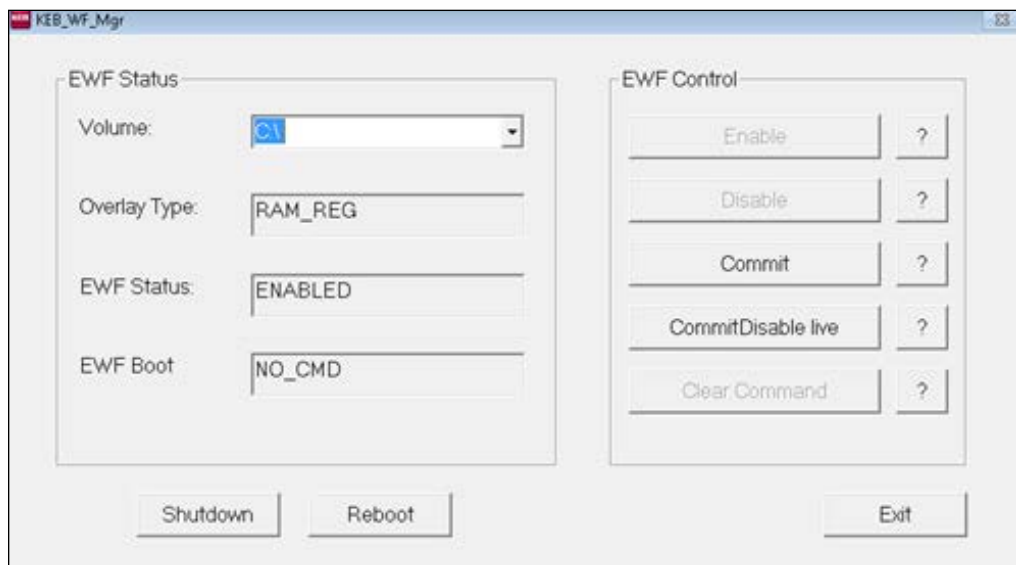

Under the Volume: you see the states of the selected volume as read-only fields:

- Overlay Type: On KEB devices always RAM-REG
- EWF Status: Current status of the EWF
- EWF Boot: Command which will be performed with the next reboot

On the right side you see the EWF control commands, each with a help button aside (the commands which are not available in the current constellation are greyed and disabled):

- **Enable:** Enables a currently disabled overlay on the specified EWF-protected volume. This function requires a reboot.
- **Disable:** Disables a currently enabled overlay on the specified EWF-protected volume. This function requires a reboot.



This function is not available at all for the volume C:\ which holds the registry, because the change in the registry for the new state of EWF cannot become persistent. Use 'CommitDisable live' instead to disable EWF for C:\

- **Commit:** Commits all current level data in the overlay to the EWF-protected volume. This function requires a reboot. After the reboot the EWF status of the volume is still "ENABLED".
- **CommitDisable live:** Immediately commits all current level data to the EWF-protected volume and then disabled EWF. This function does NOT require a reboot.

NOTICE

All changes on the volume since the last reboot become effective. Do not execute this if you are not sure about the extent of the changes.

NOTICE

The changes become effective immediately with reboot. It is not possible to undo this command with "Clear Command".

- **Clear Command:** Clears a pending command for the volume that would have occurred on the next restart.

4.4.7 Dependent Volumes (typically E:\)

As mentioned above, other volumes (in the following, typically E:\ which is the CFast on KEB devices) are dependent from volume C:\ to change their configuration because they are stored in the registry located on C:\ and thus the registry is protected against any changes, if EWF is activated for C:\

If EWF is deactivated for C:\ all commands for the dependent volumes can be used independently.

Otherwise, if EWF for C:\ is enabled, the following rules are effective:

- **Enable and Disable:** if one of these commands is used the following message box asks if the commit command for C:\ should also be set. It is recommended to confirm with "Yes" because otherwise the enable or disable has no effect. The message is not displayed if the boot command for C:\ "Commit" is already present.

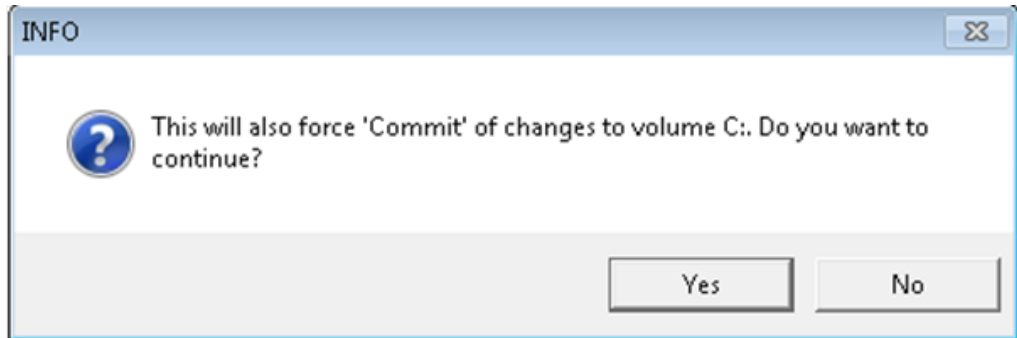

- The **Clear Command** can reset the commit without any dependency, but for Enable/Disable it asks to clear the implicitly set of commit for volume C:\, too:

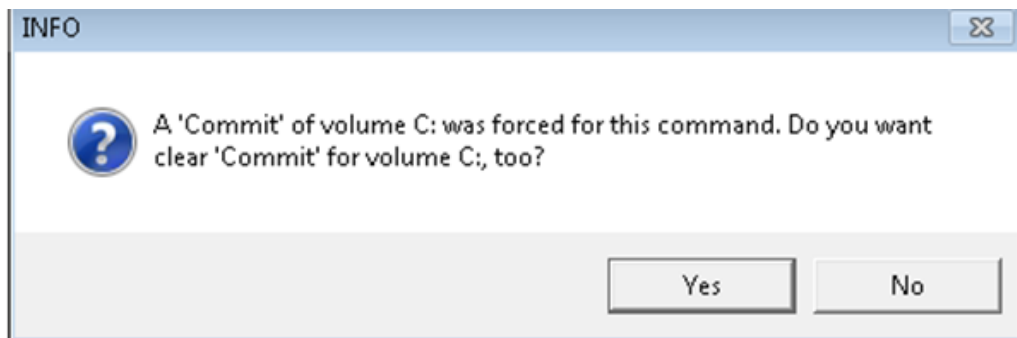

Normally you should confirm with “Yes” because the commit for volume C:\ was only set to take effect for the change of E:\.

4.4.8 Leave the KEB_WF_Mgr

A Shutdown or Reboot of the device can be initiated directly from the KEB_WF_Mgr to take effect for pending boot commands by using the particular buttons.

The program can also be left by the Exit button. In this case the program checks for pending boot commands and shows if appropriate the following message box:

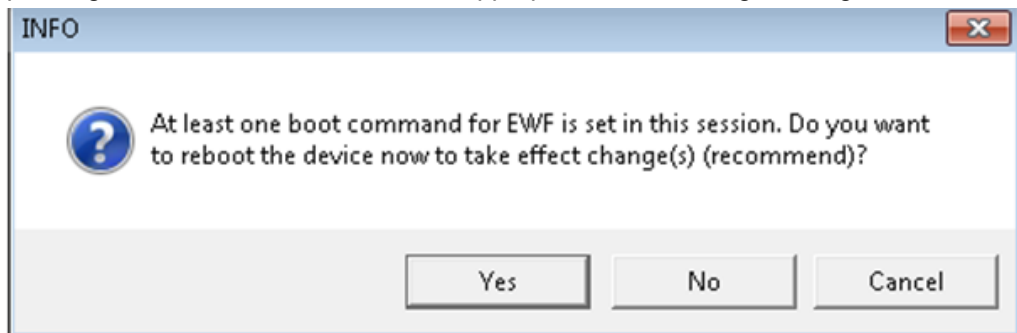

It is recommended to choose “Yes” to ensure that no subsequent changes of the system are committed accidentally; which could be happened if you quit the message box with “No”.

If you choose “Cancel” the exit of the program is discarded and you can continue to work in the KEB_WF_Mgr.

4.5 KEB UWF Manager

4.5.1 Introduction

The KEB UWF Manager offers a simple interface to use Microsoft's Unified Write Filter in Windows 10.

4.5.2 Functioning of the UWF

UWF protects your volume from write access by redirecting all write commands to a virtual overflow. The virtual overflow is a temporary memory, which is either in RAM or directly on the volume and which is cleared when the device is restarted. Any change made to the overflow affects the image, but if the change is undone, the image remains unchanged.

If the UWF is enabled for a volume, no data are permanently stored on this volume. In case of a restart or power failure, the overflow will be reset and all data from the previous session will be lost. The view will be the same after each reboot and is therefore protected against damage that can be caused by a power failure.

4.5.3 KEB UWF configuration and usage

To protect the system on volume C:\ including the registry, the overflow is configured with 4096 MB on the hard disk as standard.

KEB recommends the use of a write filter in order to increase the longevity of the devices and the data integrity. UWF Manager is disabled at the time of delivery, in order that the user can make changes during the start-up process.

Each time the device boots up with disabled UWF, the user is reminded to activate the write filter. As soon as the start-up is completed, the user can activate the write filter directly by clicking "Yes".

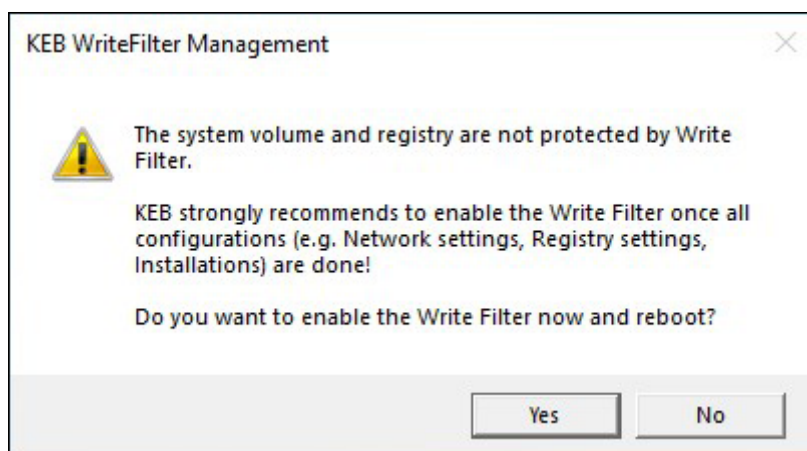

To activate the UWF Manager or to display more information about the current protection status, the KEB UWF Manager should be used, because it provides a more intuitive configuration option compared to the command line tool provided by Microsoft. A

shortcut to the KEB UWF Manager can be found on the desktop and can be executed by double click. Please note that this tool requires elevated rights, the popup window of the user account control must be confirmed with "Yes".

The program interface appears and you can protect (Protect) or not protect (Unprotect) your system. Furthermore, after activating the write filter, the overflow info (Overlay Info - Current) is displayed including type, maximum size and current usage.

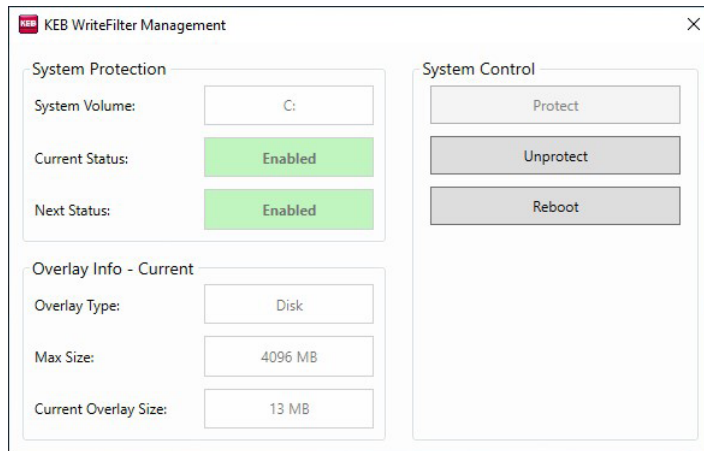
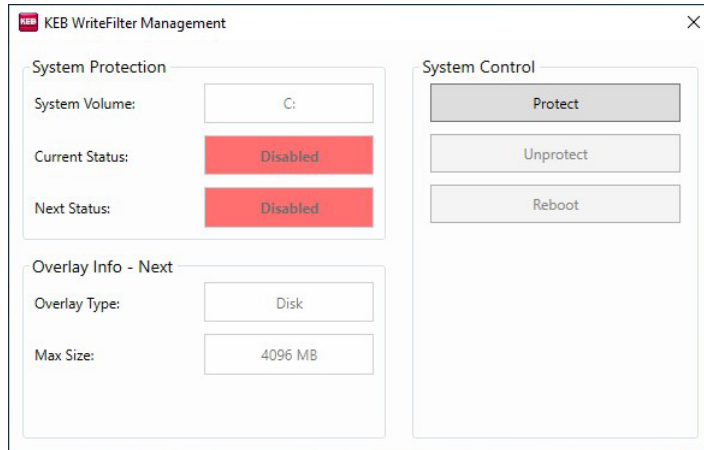

Depending on the current status of the UWF Manager, the user can protect or unprotect the system by using the buttons on the right. Both actions require a restart. If the state has changed, the "Reboot" button can be used to restart the system and to activate the set state.

In case of a state change without restart, the tool reminds the user to restart the system when leaving.

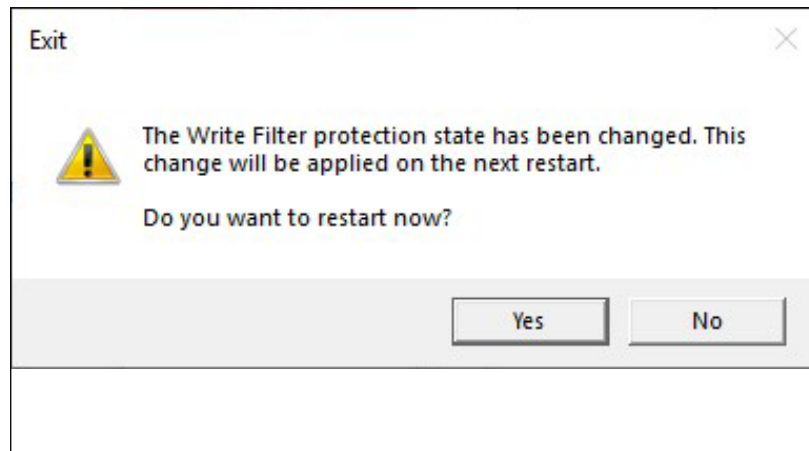

4.6 KEB Linux Image

4.6.1 Introduction

KEB has created a Linux image for C6 E22 / P3x with special features that support you in the work with the device.

4.6.2 Service user accounts

KEB Linux image has got a service account which can be used to change device settings.

Account	service
Password	service

After login to the device with the service user account the following menu is shown:

```
C6E22LX login: service
Password:
Last login: Tue Oct 29 10:13:22 2019
Welcome to service shell of host: C6E22LX

Please, select operation from list below:
 1) Show/change IP address
 2) Change hostname
 7) Show version information
 8) Change password
 9) Reboot PLC
 0) Exit
```

NOTICE

The default password for the service user account should be changed to an individual password for security reasons!

The C6 E22 / C6 P3x Linux is configured to use the IP address 192.168.0.100. This also makes it possible to set up a remote connection to the device with a development PC, e.g. if no display unit is available. To do this, configure the Ethernet adapter of the development PC with another address 192.168.0.xxx and connect to the device with Putty as service user:

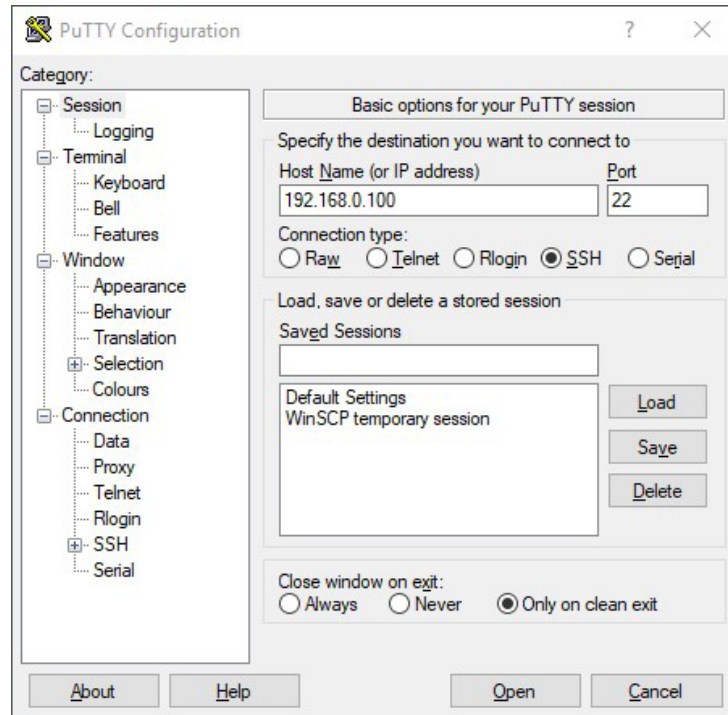

4.6.3 Change password for service user

To change the password, proceed as follows:

- Login as user “service”
- Select menu “8) Change password”
- Follow the instructions:
 - Enter old password
 - Enter new password twice. It must fulfill conditions regarding length and complexity
- Reboot the device

4.6.4 Ethernet IP Address

To switching the Ethernet address the service user menu “1) Show/change IP address”. The current IP address is shown and following sub menu occurs:

```
Current IP address: 192.168.0.100
Changing IP address:
  1) Switch network to DHCP
  2) Switch network to default static IP
  3) Switch network to static IP
  0) Back to main menu
```

Choices:

1.	Switch network to DHCP, to switch to dynamic network configuration (DHCP).
2.	Switch network to default Static IP, to switch to default static IP 192.168.0.100/24.
3.	Switch network to static IP for static network configuration.

The set e.g. the IP address 172.17.131.100 and the mask 255.255.255.0 must be entered as followed:

172.17.131.100/24

The value 24 for mask means 24 set bits in the mask beginning from left. Accordingly, 8 bits on the right are not set.

4.6.5 Usage of storage memories

The C6 E22 / P3x Linux is delivered with two hard disk drives, a SSD and a CFast card. On the SSD the Operating System and the runtimes (Control, CNC Kernel etc.) are located. The applications and data are separated and located on the CFast. Because the CFast is easy to remove the applications can be transferred to an exchange device easily.

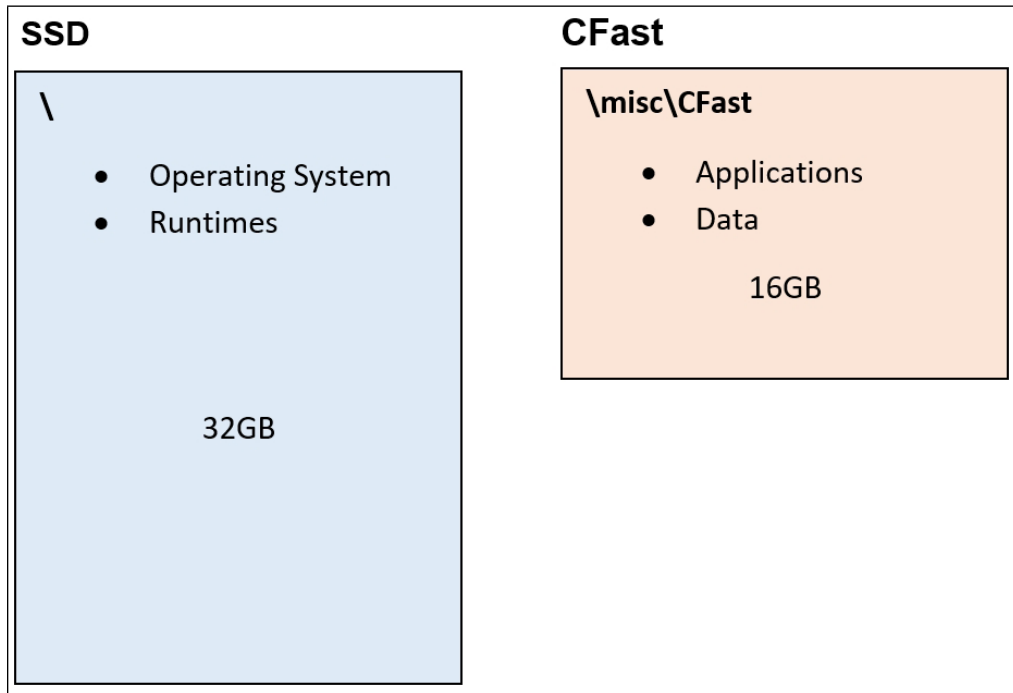

4.7 Common (Windows and Linux)

4.7.1 Micro-UPS Handling

As also mentioned in the hardware related parts of this manual all C6 E22 / P3x devices are equipped with a micro-UPS to ensure storage of Retain and Persistent variables of the Control application in case of power lost.

To avoid inconsistent data sets, the Retain and Persistent variables will be stored only if the μ USV is charged completely. Otherwise the capacity could not be sufficient to store all variables and the consistency of the data set cannot be ensured.

The charging time of the micro UPS is about 15 s for C6 E22 / P3x devices, thus normally the micro UPS is always charged until the Control application is started after a restart of the device. But for security and to keep the Control application easy portable to devices this longer charging time the charging level should be evaluated in the Control application.

For this an “Internal I/O Mapping” named “IoDrvUPS” is automatically available with the C6 E22 / P3x device in KEB COMBIVIS studio 6.

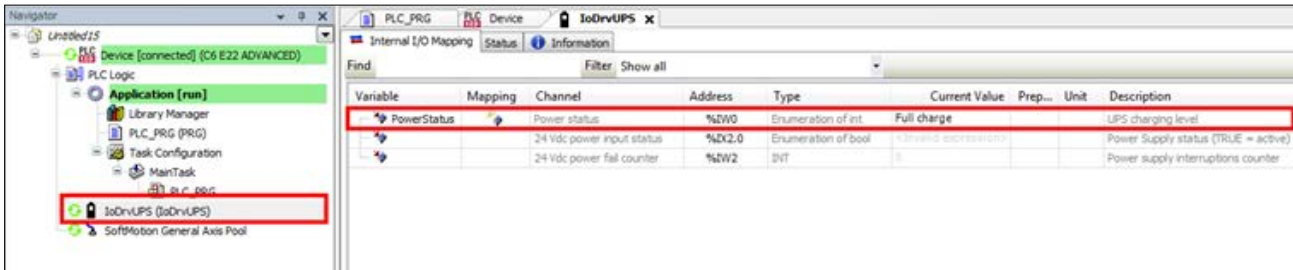

To evaluate the „Power status” inside the Control application a variable has to be defined, e.g. „PowerStatus“.

The values of Power status are:

0	Unit isn't available (must not appear on functional C6 E22 / P3x)
1	Low charge
2	Half charge
3	Full charge

The Machine application should wait until the micro-UPS is fully charged before any operation is performed which changes Retains or Persistents. This can be achieved with an implementation comparable with the following example:

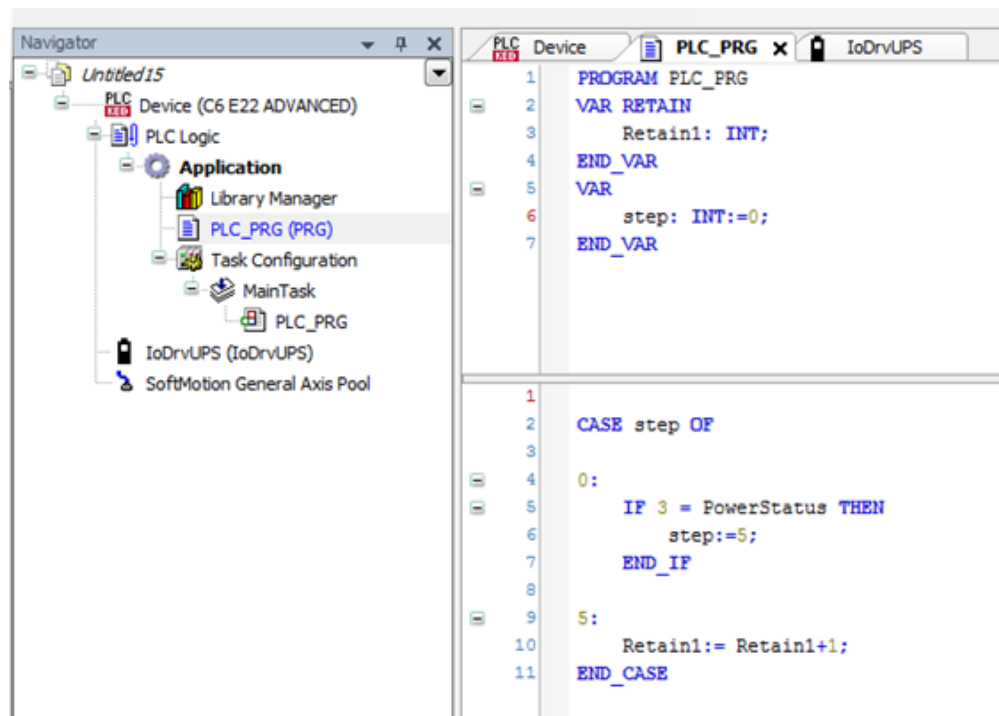

The other "Internal I/O Mapping" variables "24 Vdc power input status" and "24 Vdc power fail counter" cannot be used in a sensible manner, because the PLC is configured to stop after a short voltage drop already.

4.7.2 Ip-Scan

Ip-Scan is an IP address scanner from KEB to find other KEB devices in the network. This requires that Ip-Scan runs also on the device which should be found. The C6 E22 / P3x should be detectable by the Ip-Scan (also integrated in COMBIVIS studio 6). The Ip-Scan starts automatically after booting on the device.

Ip-Scan is not yet available on C6 E22 / P3x Linux!

4.7.3 Serial interface

The C6 E22 / C6 P3x can be equipped with an (optional) serial interface (COM ports). The following table gives an overview:

	C6 E22		C6 P33	C6 P34
	Bookmount	Panel/Box		
COM1	----	RS232	----	RS232
COM3	opt. RS232/ RS422/RS485	opt. RS232/ RS422/RS485	opt. RS232/ RS422/RS485	opt. RS232/ RS422/RS485

By default the COM port is configured to the RS232 protocol. RS422/RS485 is also possible for some devices.

In order to enable activate ports and to switch the protocol setting, it is necessary to enter the BIOS. This is done by pressing the "F2" key during start-up. You can change the settings by navigating to "Advanced/Super IO Configuration" for C6 E22 or "Advanced/F81866 Super IO Configuration" for C6 P3x. There you find the settings for the COM ports.



The names of the COM ports differ within the BIOS. In the C6 E22 BIOS, "COM1" is designated as "COM A" and "COM3" as "COM C". In C6 P3x BIOS, COM ports are called "Serial Port x", but with the same number.

Navigate to the "Mode" setting for the COM port and change it to "RS422" or "4-Wire RS485". Leave the BIOS with "F10" key to save the changes.

In Windows and/or the COMBIVIS studio 6 application no changes are necessary.

5 Maintenance and Service

The C6 E22 BOX/PANEL is equipped with a CFast slot. The CFast slot connector is operated in push-push mode.

The CFast can only be installed/removed when the C6 E22 BOX/PANEL is switched off. Otherwise, operating system, program and data files contained in CFast may be permanently damaged.



Figure 61: Remove CFast slot cover

NOTICE

Only use KEB approved CFast cards for industrial application!

All hard parts that come into contact with the touchscreen can damage it.

- ▶ All the CFast cards intended for other uses (digital cameras and other consumer products) do not have the endurance, the performance and the security features (as data reliability in case of a sudden power-off) required for an industrial application.

NOTICE

Potential data loss!

- ▶ Do not remove the CFast card while data is being accessed. Data on the CFast card may be lost if you remove the card while the C6 E22 BOX/PANEL is accessing the data.

- Remove the cover as indicated in the figure.



Figure 62: CFast slot details

NOTICE

Potential system damage!

- ▶ Do not remove the CFast card while the C6 E22 BOX/PANEL is running. Operating system and program files can be damaged and the C6 E22 BOX/PANEL can stop normal operation.

5.1 Installation

- Insert the CFast card into the slot as indicated in the figure. For correct insertion of the CFast card, the rear label should be visible.

NOTICE

CFast card alignment!

- ▶ The CFast slot does not allow incorrect insertion. Check the alignment of the CFast card if too much force is required for insertion.



Figure 63: CFast installation

5.1.1 Removal

- Push and release the CFast card as indicated in the figure.



Figure 64: Remove CFast

- Extract the memory card from the slot.

5.2 Backup battery replacement (CR2032 3V)

- Remove the battery and replace it with one of the same model (Lithium CR2032 3V Coin).

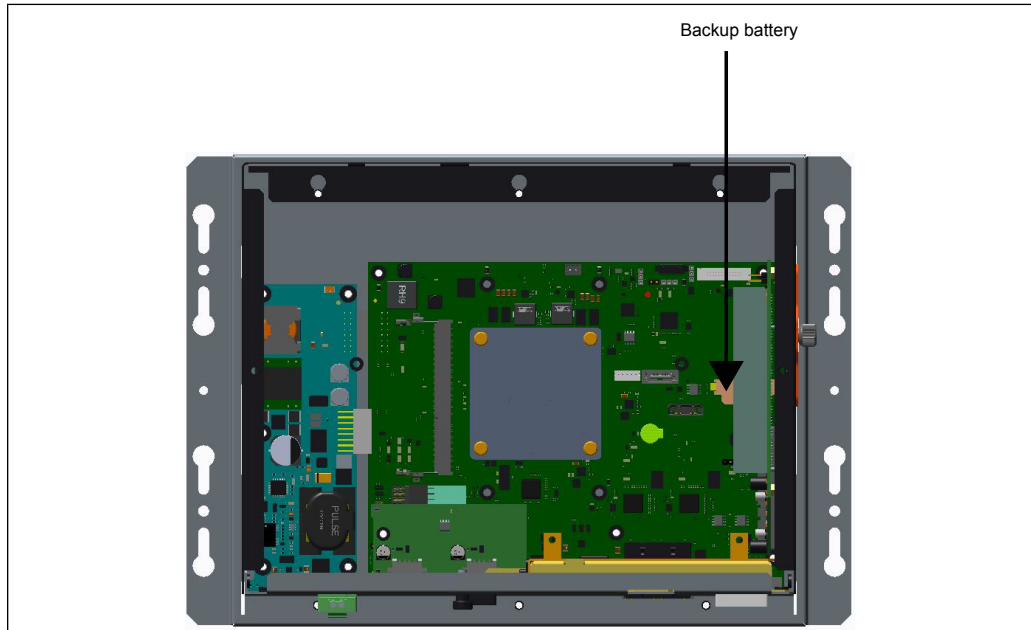

Figure 65: Battery replacement

- Follow the above order:

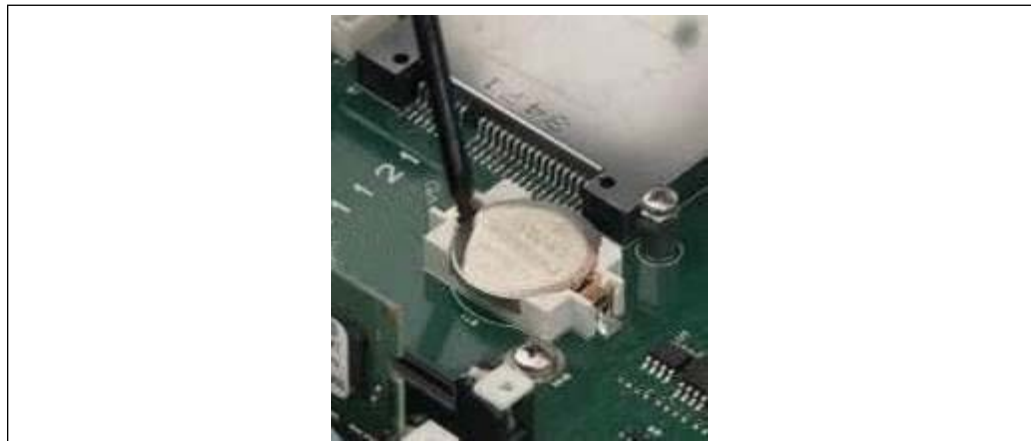

Figure 66: Battery replacement



Figure 67: Battery replacement



Figure 68: Battery replacement

Insert battery:

When inserting a new battery:

- Make sure that one side of the battery is first inserted under the two golden contacts and then press down the other side of the battery until it snaps into the plastic holder.
- Do not tilt the battery so that the two golden contacts are not bent!
- When switching on for the first time after a battery change, do not switch off the device for at least 20 seconds.
- The card needs this time to perform a restart for initial configuration.
- If the power supply was interrupted within this time, remove the battery and repeat the procedure.

5.3 Touchscreen calibration

The C6 E22 PANEL is designed by way that no user touchscreen calibration is required. However, this may be necessary in some special cases, such as when updating the operating system. Please follow these instructions.

- Go to control panel or click the system tray icon and open the eGalax setup application.



Figure 69: Calibration of the touchscreen

- Select the 'Tools' tab

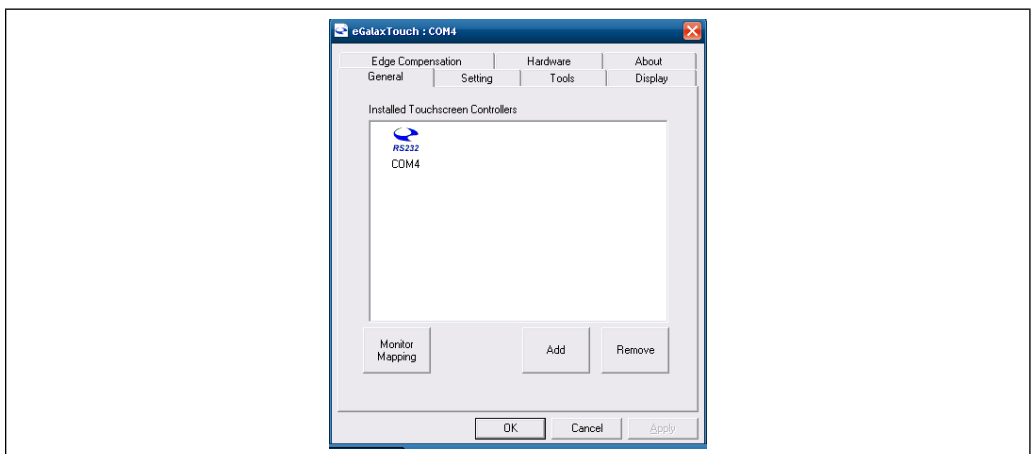

Figure 70: Calibration of the touchscreen

Select '4 point calibration'.

A more accurate option is available: 'Linearization'.

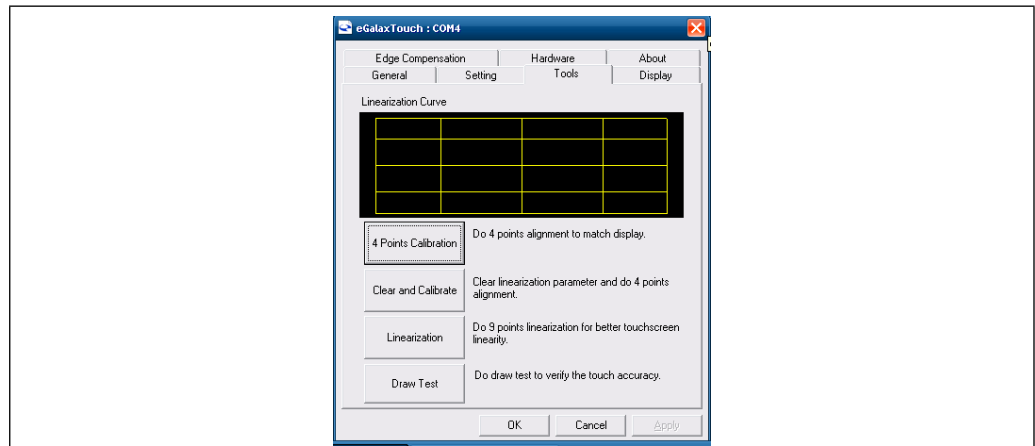

Figure 71: Calibration of the touchscreen

- The user should follow the on-screen instructions and follow the flashing icon in the calibration window until "OK" is displayed to ensure that the utility has enough data for the calculation.



Figure 72: Calibration of the touchscreen

5.3.1 Touchscreen application tips

Touchscreen operation with the finger has several effects on application usage. Here are some useful tips.

Use large keys and a simple operator interface

Avoid complex user operations, such as double-clicks, scroll bars, drop-down menus, using multiple windows or moving the elements. Remember that not all the operations that can be done with a mouse are as convenient with a touchscreen.

The user should receive feedback as soon as he touches the screen.

Immediate feedback on successful touch operation is very important for the user.

The feedback can either be visual (change of the key alignment / 3D effects) or audio ("beep" or "click" when touched).

Switch off the cursor

It will help the user to focus on the entire screen, without being distracted by the cursor pointer.

Run your application full screen

Remove title and menu bars, to use the entire display area.

Avoid a black background

Bright backgrounds that may contain a pattern are a better choice for reducing glare and fingerprints.

5.3.2 Maintaining & cleaning

The C6 E22 BOX/PANEL is designed for maintenance-free operation, except for the replacing of the battery backup (if necessary). It is recommended to clean the touchscreen with a damp cleaning cloth and a display cleaning solution.



Clean the front panel of the system with a soft damp cloth only.

NOTICE

Cleaning procedure!

- ▶ Do not use cleaning agents, solvents, cleaners or objects that could scratch the surface.
 - ▶ Switch off the power supply before each cleaning process to avoid unintended functions.
-

5.3.3 Procedure

Proceed as follows:

- a) Switch off the C6 E22 PANEL device or lock the touchscreen.
- b) Spray the cleaning solution onto a cleaning cloth..
- c) Do not spray directly onto the display.
- d) Clean the display from the screen edge inwards.

5.4 Technical support & repairs

KEB offers wide-ranging, complete after-sales technical support. The staff who deal with this handle questions on the entire range of products skillfully, quickly, and efficiently.

You can phone our staff in the service department, and they will give you complete, prompt advice on how to resolve your problems.

Telefon: +49 5263 401 0

Fax: +49 5263 401 116

E-Mail: combicontrol@keb.de

5.5 Recycling and disposal

The C6 E22 BOX/PANEL can be recycled due to the use of materials with low environmental impact. Contact a certified disposal service company for environmentally sound recycling and disposal of your old devices.

6 Technical Specifications

6.1 LCD characteristics

Size (inch)	10.1" W	10.4" SVGA	12.1" WXGA
Type	Color LCD TFT	Color LCD TFT	Color LCD TFT
Resolution (pxl x pxl)	1280x800	800x600	1280x800
Colors	16.7M	16.2M	16.2M
Pixel pitch (mm)	0.1695x0.1695	0.264x0.264	0.204x0.204
Backlight	LED	LED	LED
Luminosity (cd/m ²)	400	400	400
Contrast	800:1	700:1	1000:1
Viewing angle typ. (°)	85°:85° (L/R)	80°:80° (L/R)	88°:88° (L/R)
	85°:85° (U/L)	70°:70° (U/L)	88°:88° (U/L)
Lifetime (min.)	100,000h	50,000h	50,000h

Table 12: LCD characteristics

Size (inch)	12.1" SVGA	15.0" XGA
Type	Color LCD TFT	Color LCD TFT
Resolution (pxl x pxl)	800x600	1024x768
Colors	16.2M	16.2M
Pixel pitch (mm)	0.3075x0.3075	0.297x0.297
Backlight	LED	LED
Luminosity (cd/m ²)	500	500
Contrast	800:1	1500:1
Viewing angle typ. (°)	80°:80° (L/R)	85°:85° (L/R)
	80°:60° (U/L)	85°:85° (U/L)
Lifetime (min.)	100,000h	50,000h

Size (inch)	15.6" WXGA	17.0" SXGA
Type	Color LCD TFT	Color LCD TFT
Resolution (pxl x pxl)	1366x768	1280x1024
Colors	16.7M	16.7M
Pixel pitch (mm)	0.252x0.252	0.264x0.264
Backlight	LED	LED
Luminosity (cd/m ²)	400	350
Contrast	500:1	1000:1
Viewing angle typ. (°)	85°:85° (L/R)	85°:85° (L/R)
	80°:80° (U/L)	80°:80° (U/L)
Lifetime (min.)	50,000h	50,000h

Size (inch)	18.5" WXGA	19.0" SXGA	21.5" FHD
Type	Color LCD TFT	Color LCD TFT	Color LCD TFT
Resolution (pxl x pxl)	1366x768	1280x1024	1920x1080
Colors	16.7M	16.7M	16.7M
Pixel pitch (mm)	0.300x0.300	0.294x0.294	0.248x0.248
Backlight	LED	LED	LED
Luminosity (cd/m ²)	300	350	300
Contrast	1000:1	1500:1	5000:1
Viewing angle typ. (°)	75°:75° (L/R)	85°:85° (L/R)	89°:89° (L/R)
	70°:70° (U/L)	85°:85° (U/L)	89°:89° (U/L)
Lifetime (min.)	50,000h	70,000h	50,000h

Size (inch)	24.0" WXGA
Type	Color LCD TFT
Resolution (pxl x pxl)	1920x1080
Colors	16.7M
Pixel pitch (mm)	0.276x0.276
Backlight	LED
Luminosity (cd/m ²)	300
Contrast	5000:1
Viewing angle typ. (°)	89°:89° (L/R)
	89°:89° (U/L)
Lifetime (min.)	50,000h



Pixel defects in the TFT display are production-related and do not constitute grounds for complaint (according to ISO 13406-2, Class II).

All displays are color TFT-LCD with LED backlight designed for industrial application.

6.2 C6 E22 PANEL resistive - Technical data

Housing	Panel mounting	
Front panel	Aluminum ▪ KEB Logo Sticker	
Touchscreen	5 wires resistive technology ▪ on board controller	
Frontal Protection	IP66	
Power supply	24V DC Input voltage: 18÷32V DC Isolated	
Micro UPS	Micro UPS was developed for use in combination with CONTROL Soft PLC. The Micro UPS module is installed on an internal power supply unit.	
Motherboard	Type "All-In-One" MB 954	
Watchdog	Time programmable	
Intel platform processor	Intel® Celeron® J1900 ▪ 2,00 GHz (2,42 GHz Burst), 2MB L2 cache ▪ 4 cores, 4 threads ▪ Soldered on-board	
Operating System certified by KEB	Microsoft Windows Embedded Standard 7E/7P 32/64 bit	
	Microsoft Windows 10 IoT Enterprise 2019 - LTSC - Entry	
	Linux	
	Other operating systems, such as VxWorks, QNX, etc., have not been certified by KEB but they are supported by the Intel platform after compatibility checks.	
Operating System not supported by Intel platform	Microsoft Windows XP / 2000 / 98 / NT ▪ Microsoft Windows CE 5 / 6	
Video controller	Intel® HD Graphics integrated into Intel® Celeron™ microprocessor ▪ 688MHz ▪ I/F Digital LVDS a 8bit/color	
Video RAM (shared)	Dynamic Video Memory Technology ▪ Memory quantity is automatically selected by operating system (max 1720 MB)	
System memory	DDR3-1066 type ▪ 1 SODIMM module ▪ min 1GB ▪ max 8GB	
Mass storage interfaces	SL	1 x mSATA 2, 3Gb/s
	S1	1 x mSATA 2, 3Gb/s
CFast slot	1 x CFast slot (bootable) external access	
Bus extension slots on the riser card (S1)	1 x PCI or 1 x PCIe x1 ▪ version "half size" with 3W max consumption ▪ alternatively to each other	
Interfaces (rear of device)	2 x Ethernet 10/100/1000 Mbps (RJ45), Intel® I210 1 x USB 3.0 (TypeA) 2 x USB 2.0 (Type A) 1 x DVI-I Single Link (max resolution: DVI-D/VGA 1920x1080 FullHD)	
Serial port (rear of device)	1 x RS-232 (DB9M)	
Environmental specifications	Operating temperature: 0° ÷ +50°C, 0°C ÷ +45°C with 24x7 HDD, +5°C ÷ +45°C standard equipment HDD Storage temperature: -20° ÷ +60°C Humidity: 80% (noncondensing)	
Approvals	CE (EN 55022, EN 61000-3-2/3, EN 55024, EN 60950-1) cULus LISTED (UL508)	
Standard warranty	12 months ▪ Warranty management by KEB headquarters	
<i>Table 13: C6 E22 BOX/PANEL Technical data</i>		

Options	SL	S1	
SSD mSATA >Note 3*	•	•	SSD mSATA, MLC
CFAST	•	•	CFAST SATA2
Communication ports	/	•	1 x RS232/422/485 optoisolated serial port (DB15M) 1 x USB 2.0 Port > Note 4
	/	•	1 x Ethernet 10/100/1000Mbps, Intel® I210
<i>Table 14: Common options</i>			

Note*:

For the calculation of the power consumption we recommend to read the notes in section 6.5. The performance values do not include the power consumed by USB devices connected to the ports.

Note 1* Glass foil glass (GFG) touchscreen option.

Note 2* UPS functions are only guaranteed with Microsoft Win32/64 bits operating systems.

Note 3* mSATA SSD and 2.5" SSD/HDD devices cannot be installed together.

Note 4* Communication ports marked with note 4 cannot be installed together.

6.3 C6 E22 PANEL capacitive - Technical data

Housing	Panel mounting	
Front panel	Aluminium and tempered glass TrueFlat ▪ KEB Logo Silk screen printing	
Touchscreen	Capacitive 4-finger-Multi-Touch	
Frontal Protection	IP66K	
Power supply	24V DC input voltage: 18÷32V DC isolated	
Micro UPS	Micro UPS was developed for use in combination with CONTROL Soft PLC. The micro UPS module is installed on an internal power supply unit.	
Motherboard	Type "All-In-One" MB 954	
Watchdog	Time programmable	
Intel platform processor	Intel® Celeron® J1900 ▪ 2.00 GHz (2.42 GHz Burst), 2MB L2 cache ▪ 4 cores, 4 threads ▪ Soldered on-board	
Operating System certified by KEB	Microsoft Windows Embedded Standard 7E/7P 32/64 bit	
	Microsoft Windows 10 IoT Enterprise 2019 - LTSC - Entry	
	Linux	
	Other operating systems, such as VxWorks, QNX, etc., have not been certified by KEB but they are supported by the Intel platform after compatibility checks.	
Operating System not supported by Intel platform	Microsoft Windows XP / 2000 / 98 / NT ▪ Microsoft Windows CE 5 / 6	
Video controller	Intel® HD Graphics integrated into Intel® Celeron™ microprocessor ▪ 688MHz ▪ I/F Digital LVDS a 8bit/color	
Video RAM (shared)	Dynamic Video Memory Technology ▪ Memory quantity is automatically selected by operating system (max 1720 MB).	
System memory	DDR3-1066 type ▪ 1 SODIMM module ▪ min 1GB ▪ max 8GB	
Mass storage interfaces	SL	1 x mSATA 2, 3Gb/s
	S1	1 x mSATA 2, 3Gb/s
CFast slot	1 x CFast slot (bootable) external access	
Bus extension slots on the riser card (S1)	1 x PCI or 1 x PCIe x1 ▪ version "half size" with 3W max consumption ▪ alternatively to each other	
Interfaces (rear of device)	2 x Ethernet 10/100/1000 Mbps (RJ45), Intel® I210 1 x USB 3.0 (TypeA) 2 x USB 2.0 (Type A) 1 x DVI-I Single Link (max resolution: DVI-D/VGA 1920x1080 FullHD)	
Serial port (rear of device)	1 x RS-232 (DB9M)	
Environmental specifications	Operating temperature: 0° ÷ +50°C, 0°C ÷ +45°C with 24x7 HDD, +5°C ÷ +45°C standard equipment HDD Storage temperature: -20° ÷ +60°C Humidity: 80% (non-condensing)	
Approvals	CE (EN 55022, EN 61000-3-2/3, EN 55024, EN 60950-1) cULus LISTED (UL508)	
Standard warranty	12 months ▪ Warranty management by KEB headquarters	
<i>Table 15: C6 E22 PANEL Technical data</i>		

Options	SL	S1	
SSD mSATA >Note 2*	•	•	SSD mSATA, MLC
CFAST	•	•	CFAST SATA2
Communication ports	/	•	1 x RS232/422/485 optoisolated serial port (DB15M) 1 x USB 2.0 Port > Note 3
	/	•	1 x Ethernet 10/100/1000Mbps, Intel® I210
<i>Table 16: Common options</i>			

Note*:

For the calculation of the power consumption we recommend to read the notes in section 6.5. The performance values do not include the power consumed by USB devices connected to the ports.

- Note 1* The UPS module is supported by Microsoft Win32/64 operating systems.
- Note 2* mSATA SSD and 2.5" SSD/HDD devices cannot be installed together.
- Note 3* Communication ports marked with note 3 cannot be installed together.

6.4 C6 E22 Box Technical data

Housing	Wall and DIN rail mounting	
Power supply	24V DC input voltage: 18÷32V DC isolated	
Micro UPS	Micro UPS was developed for use in combination with CONTROL Soft PLC. The Micro UPS module is installed on an internal power supply unit.	
Motherboard	Type "All-In-One" MB 954	
Watchdog	Time programmable	
Intel platform processor	Intel® Celeron® J1900 ▪ 2.00 GHz (2.42 GHz Burst), 2MB L2 cache ▪ 4 cores, 4 threads ▪ Soldered on-board	
Operating System certified by KEB	Microsoft Windows Embedded Standard 7E/7P 32/64 bit	
	Microsoft Windows 10 IoT Enterprise 2019 - LTSC - Entry	
	Linux	
	Other operating systems, such as VxWorks, QNX, etc., have not been certified by KEB but they are supported by the Intel platform after compatibility checks.	
Operating System not supported by Intel platform	Microsoft Windows XP / 2000 / 98 / NT ▪ Microsoft Windows CE 5 / 6	
Video controller	Intel® HD Graphics integrated into Intel® Celeron™ microprocessor ▪ 688MHz ▪ I/F Digital LVDS a 8bit/color	
Video RAM (shared)	Dynamic Video Memory Technology ▪ Memory quantity is automatically selected by operating system (max 1720 MB).	
System memory	DDR3-1066 type ▪ 1 SODIMM module ▪ min 1GB ▪ max 8GB	
Mass storage interfaces	SL	1 x mSATA 2, 3Gb/s
	S1	1 x mSATA 2, 3Gb/s
CFast slot	1 x CFast slot (bootable) external access	
Bus extension slots on the riser card (S1)	1 x PCI or 1 x PCIe x1 ▪ version "half size" with 3W max consumption ▪ alternatively to each other	
Interfaces (rear of device)	2 x Ethernet 10/100/1000 Mbps (RJ45), Intel® I210 1 x USB 3.0 (Type A) 2 x USB 2.0 (Type A) 1 x DVI-I Single Link (max resolution: DVI-D/VGA 1920x1080 FullHD)	
Serial port (rear of device)	1 x RS-232 (DB9M)	
Environmental specifications	Operating temperature: 0° ÷ +50°C, 0°C ÷ +45°C with 24x7 HDD, +5°C ÷ +45°C standard equipment HDD Storage temperature: -20° ÷ +60°C Humidity: 80% (non-condensing)	
Approvals	CE (EN 55022, EN 61000-3-2/3, EN 55024, EN 60950-1) cULus LISTED (UL508)	
Standard warranty	12 months ▪ Warranty management by KEB headquarters	
<i>Table 17: C6 E22 Box Technical data</i>		

Options	SL	S1	
SSD mSATA >Note 2*	•	•	SSD mSATA, MLC
CFAST	•	•	CFAST SATA2
Communication ports	/	•	1 x RS232/422/485 optoisolated serial port (DB15M) 1 x USB 2.0 Port > Note 3
	/	•	1 x Ethernet 10/100/1000Mbps, Intel® I210

Table 18: Common options

Note*:

For the calculation of the power consumption we recommend to read the notes in section 6.5. The performance values do not include the power consumed by USB devices connected to the ports.

Note 1* The UPS module is supported by Microsoft Win32/64 operating systems.

Note 2* mSATA SSD and 2.5" SSD/HDD devices cannot be installed together.

Note 3* Communication ports marked with note 3 cannot be installed together.

6.5 Power consumption

This section contains the information needed to calculate the absorbed power of each system configuration.

6.5.1 Calculation of the absorbed power

It is possible to calculate the maximum absorbed power for each system configuration by adding the power input of the single components listed in the table "Basic System" and the absorbed power of any installed and listed options from the "Options" table.

6.5.2 This is how you determine the power consumption

The 24V DC power consumption unit is watt [W] and is displayed in the column power, which is calculated according to the following criteria:

- All power consumption values are calculated considering the maximum absorbed power of each component. The power consumption sum is multiplied with the coefficient that represents the internal power supply efficiency.
- The Intel® CoreT microprocessors with turbo mode increase their typical power consumption for a short time (5-10 seconds).
- The LCD power consumption value refers to the maximum LCD brightness.
- The SSD, CF or CFAST power consumption value depends on the memory size. For a simple calculation, we have indicated the power consumption of the largest available memory size in the price list and configurator.
- The power consumption of USB devices connected to the systems is not included in the basic configuration about the power consumption. The power consumption of the connected USB devices must be considered and added to the total consumption. We emphasize that a USB 2.0 device can consume a maximum of 3.3 W and a USB 3.0 device can consume 5.9 W. These values are calculated by multiplying the maximum power consumption defined in the USB standard (2.5 W and 4.5 W) by the coefficient representing the internal power supply efficiency.
- The power consumption of the basic system configuration with expansion slots includes the maximum permissible power consumption for any installed expansion cards.

6.5.2.1 Basic system

Section	Item	Power (W)
Motherboard	MB954	2.6
Processor	Intel® Celeron® J1900 ▪ 2.00 GHz (2.42 GHz Burst), 2MB L2 Cache ▪ 4 cores, 4 threads ▪ soldered on the board	13.1
Display	10.1" LCD	5.5
	10.4" LCD	6.8
	12.1" LCD (SVGA)	11.9
	12.1" LCD (WXGA)	13.3
	15.0" LCD	19.4
	15.6" LCD	19.0
	17.0" LCD	28.8
	18.5" LCD	24.4
	19.0" LCD	36.3
	21.5" LCD	35.2
RAM memory	24.0" LCD	39.2
	1 GB	2.6
	2 GB	3.3
	4 GB	3.9
Internal voltage supply	8 GB	4.6
	24VDC	0.0
	24VDC with integrated µUPS	0.7
Extension slots	S1	3.9

Table 19: Basic system consumption

6.5.2.2 Options

Section	Item	Power (W)
SSD mSATA	SSD mSATA, MLC	2.0
CFAST	CFAST SATA 2	1.3
I/O interfaces	1 x RS232/422/485 (DB15M) optoisolated	1.3
	1 x USB 2.0	
	1 x Ethernet 10/100/1000Mbps, Intel® I210	1.3

6.5.3 How to select the 24 V DC voltage supply

This section contains tips for selecting the 24 V voltage supply for E22 BOX/PANEL.

- The rated output power should be 25% higher than the power loss of the C6 E22 BOX/PANEL.
- The rise time of the output voltage must be less than 100 ms.
- Consider the operating temperature and the thermal power reduction of the voltage supply.

7 Drawings

7.1 Drawings

The following drawings comply with the "Projection Method 1" of the European Standards (represented by the following symbol).

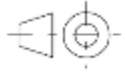

7.1.1 C6 E22 PANEL / SL / 10.1" W

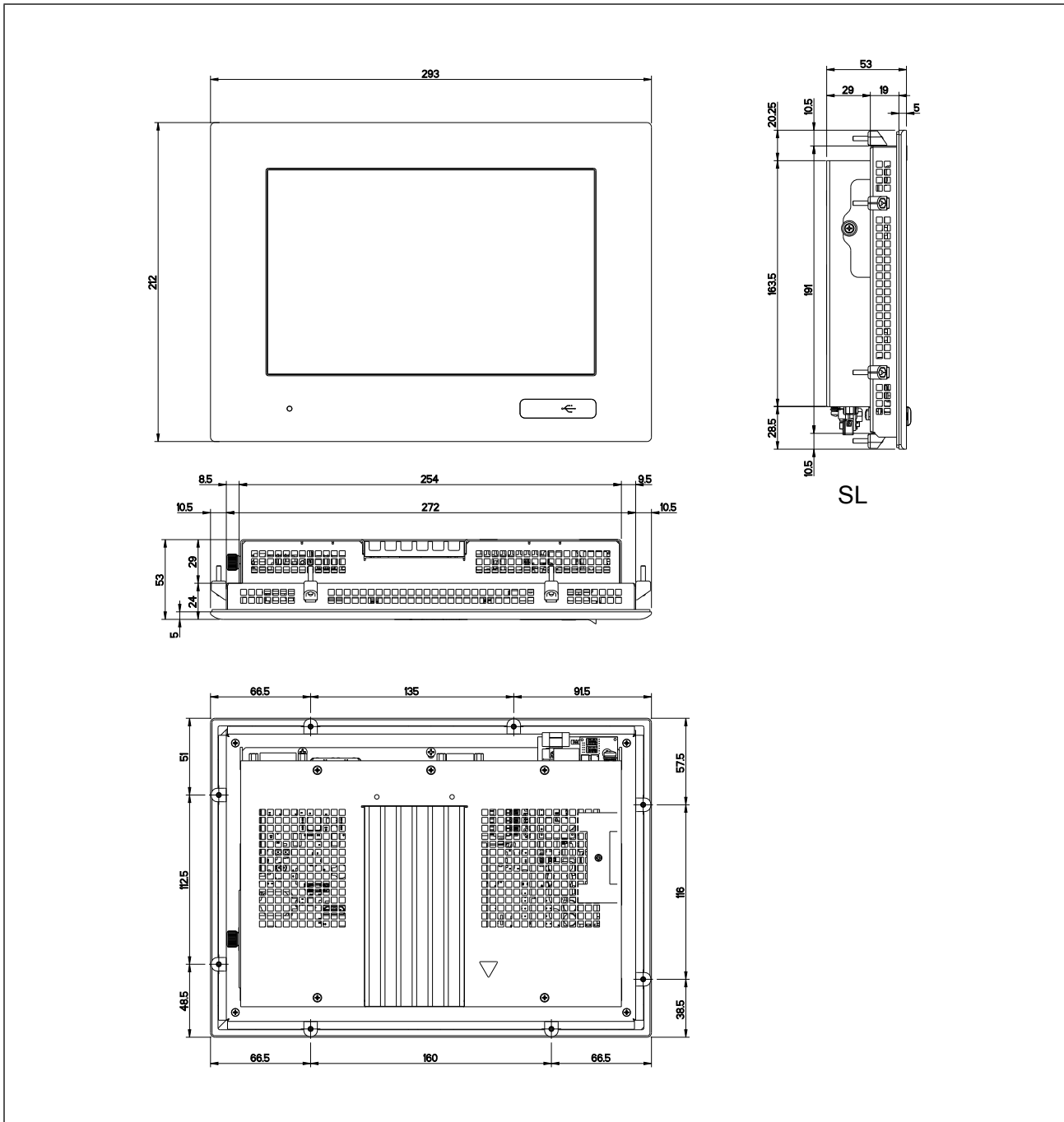

Figure 73: 10.1" W dimensions

7.1.2 C6 E22 PANEL / SL-S1 / 10.4"

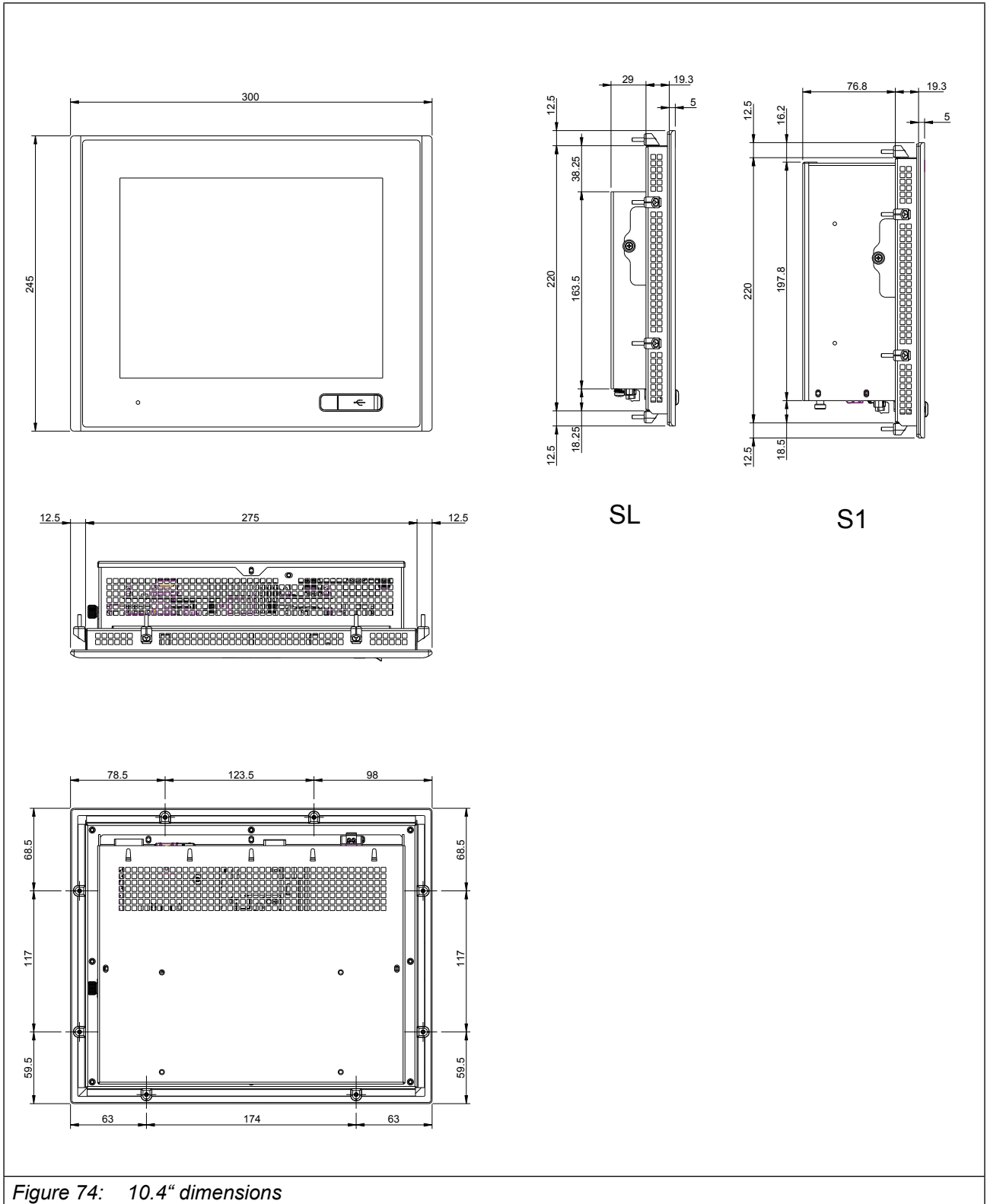

Figure 74: 10.4" dimensions

7.1.3 C6 E22 PANEL / SL-S1 / 12.1"

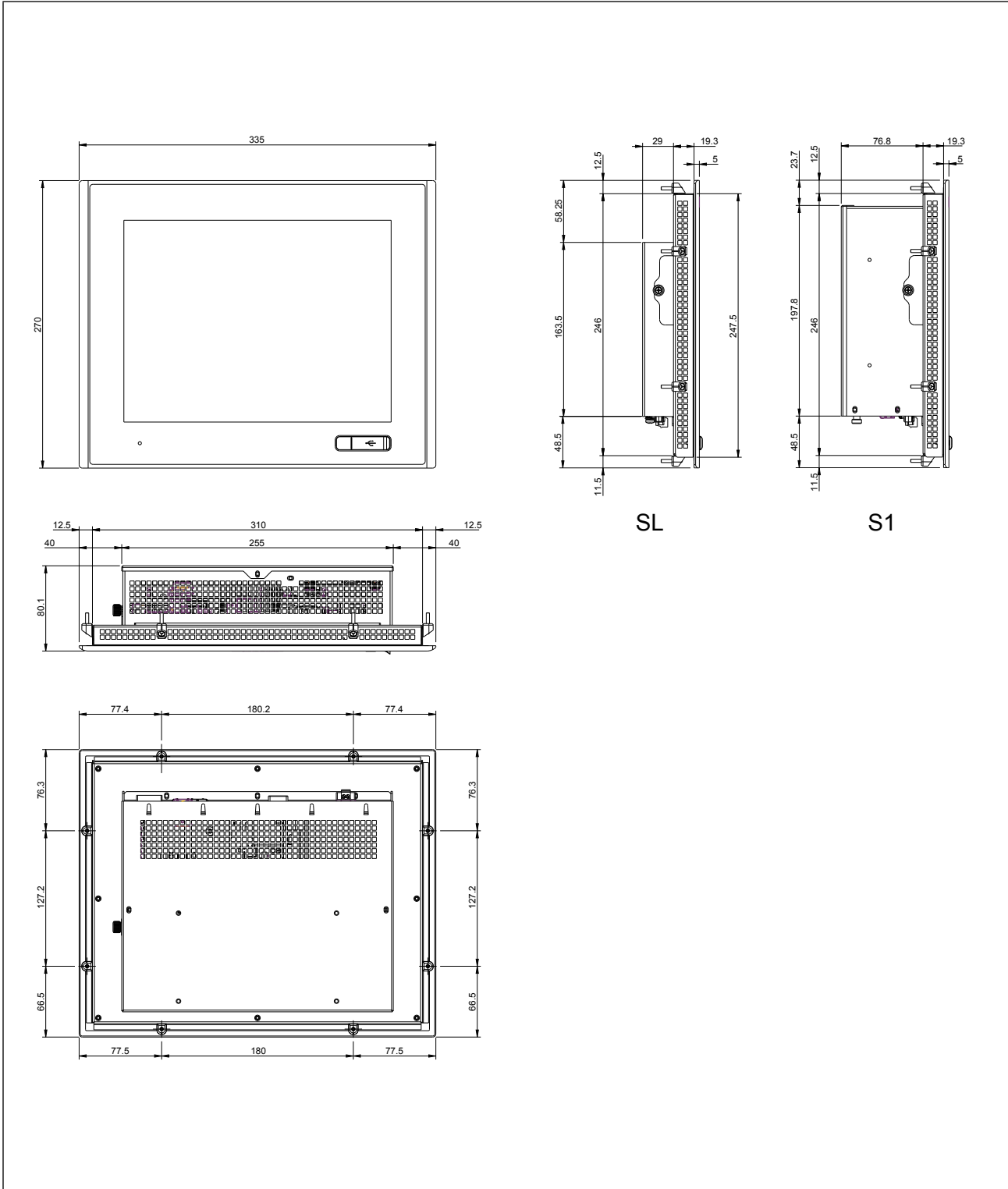

Figure 75: 12.1" dimensions

7.1.4 C6 E22 PANEL / SL-S1 / 12.1" W

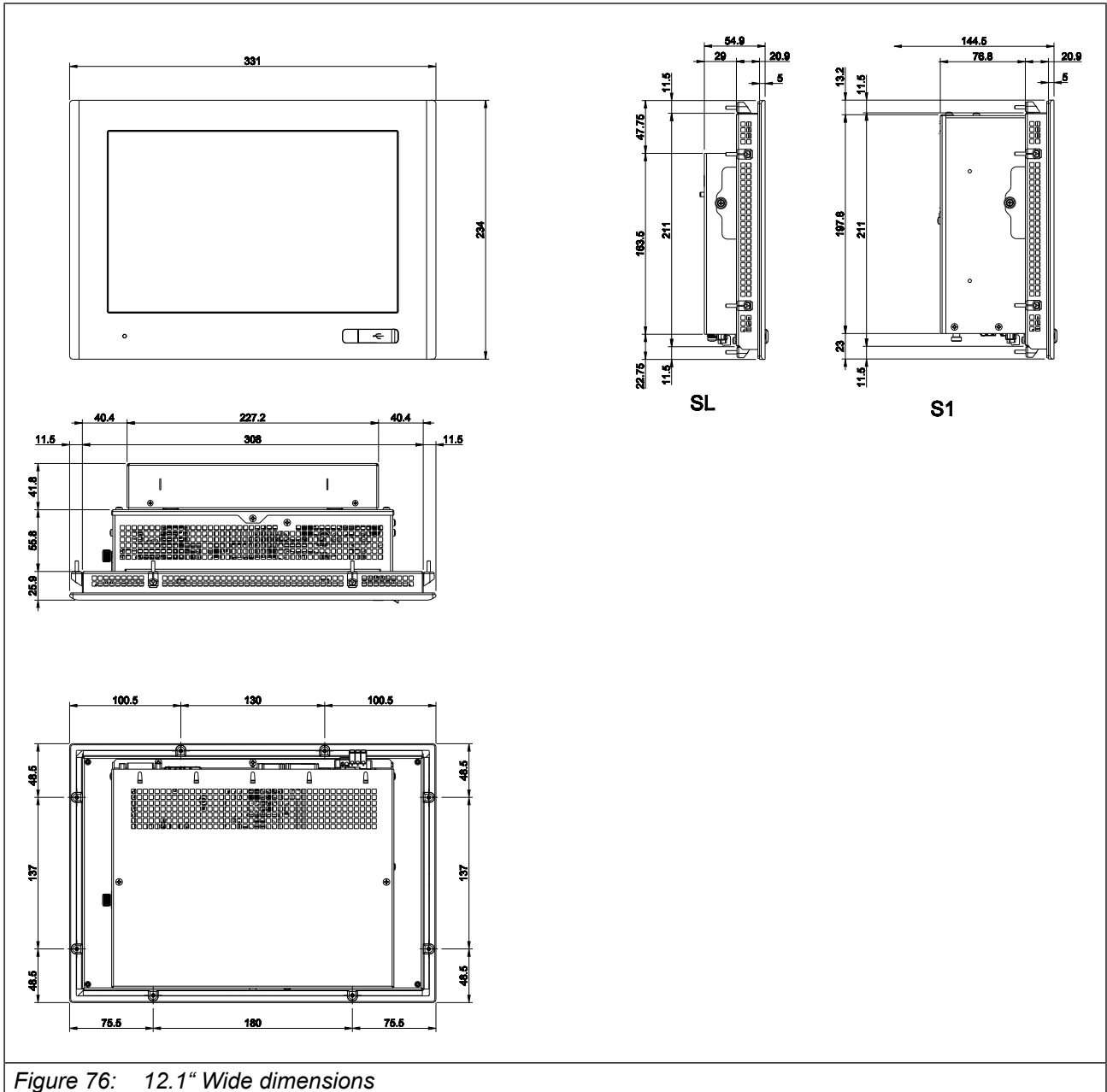

Figure 76: 12.1" Wide dimensions

7.1.5 C6 E22 PANEL SL-S1 / 15.0"

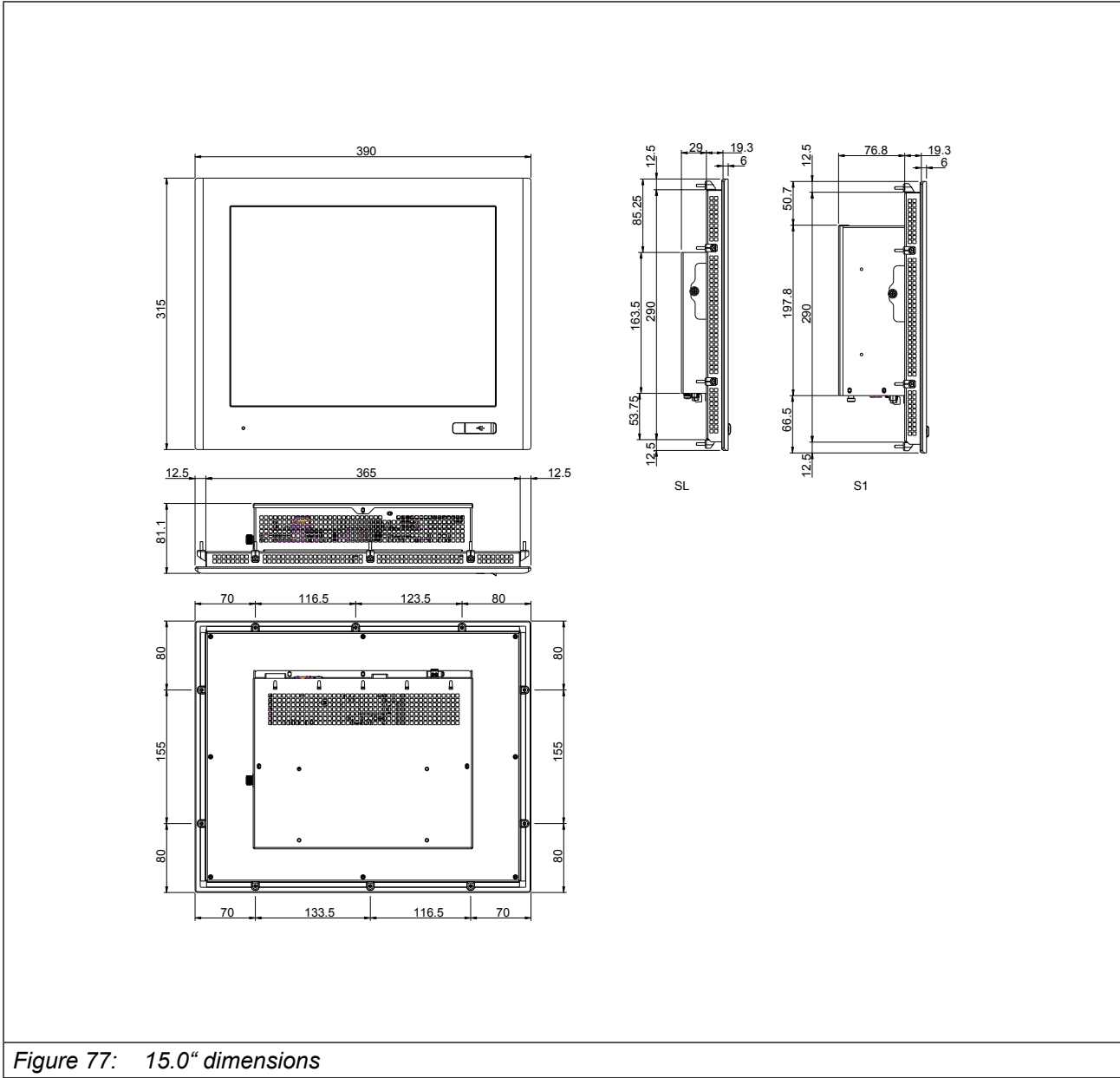

Figure 77: 15.0" dimensions



TFX models do not have an USB port on the front.



TFX PANEL dimensions 398 x 315.

7.1.6 C6 E22 PANEL / SL-S1 / 15.6" W

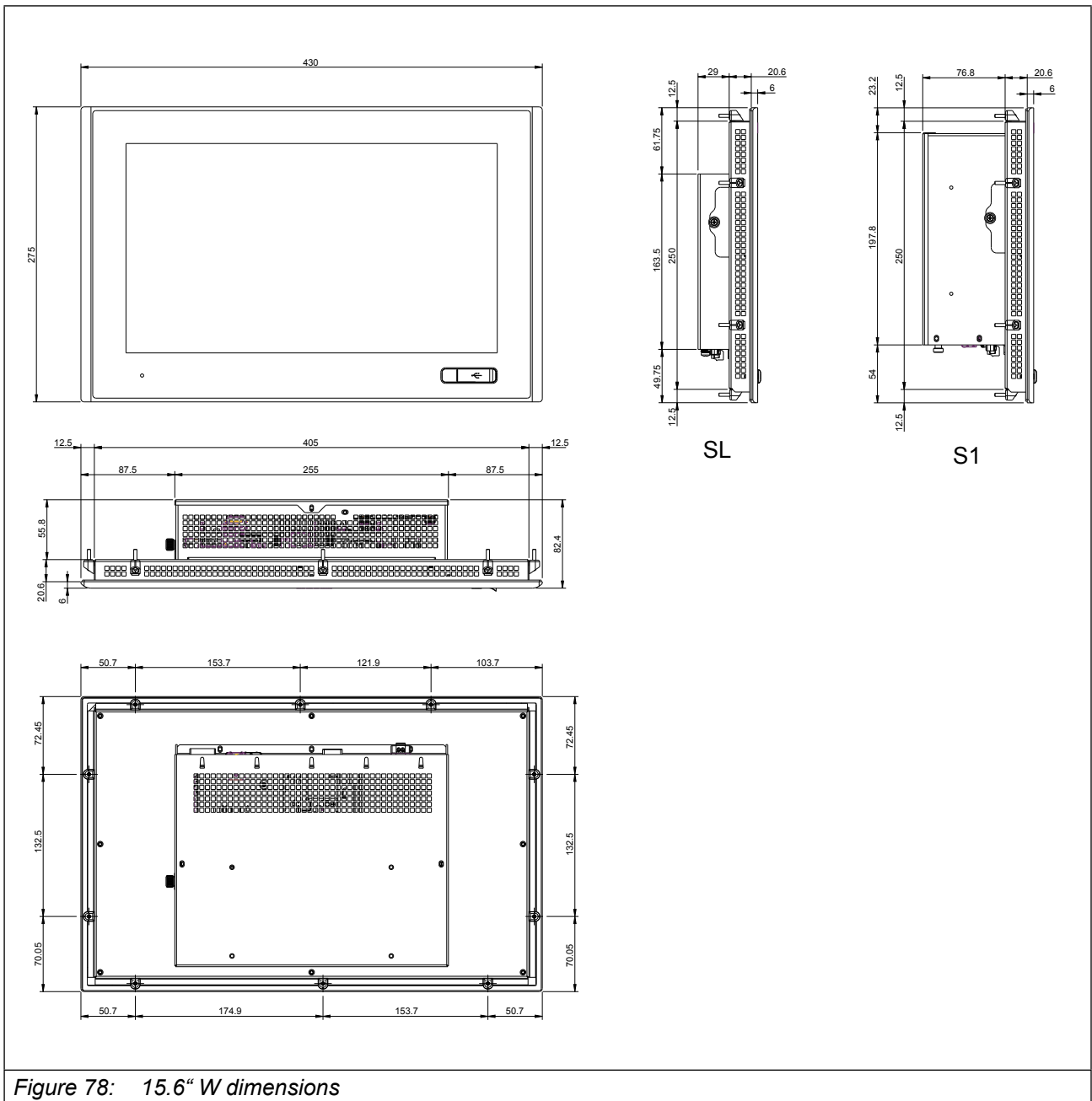

Figure 78: 15.6" W dimensions

7.1.7 C6 E22 PANEL / SL-S1 / 17.0"

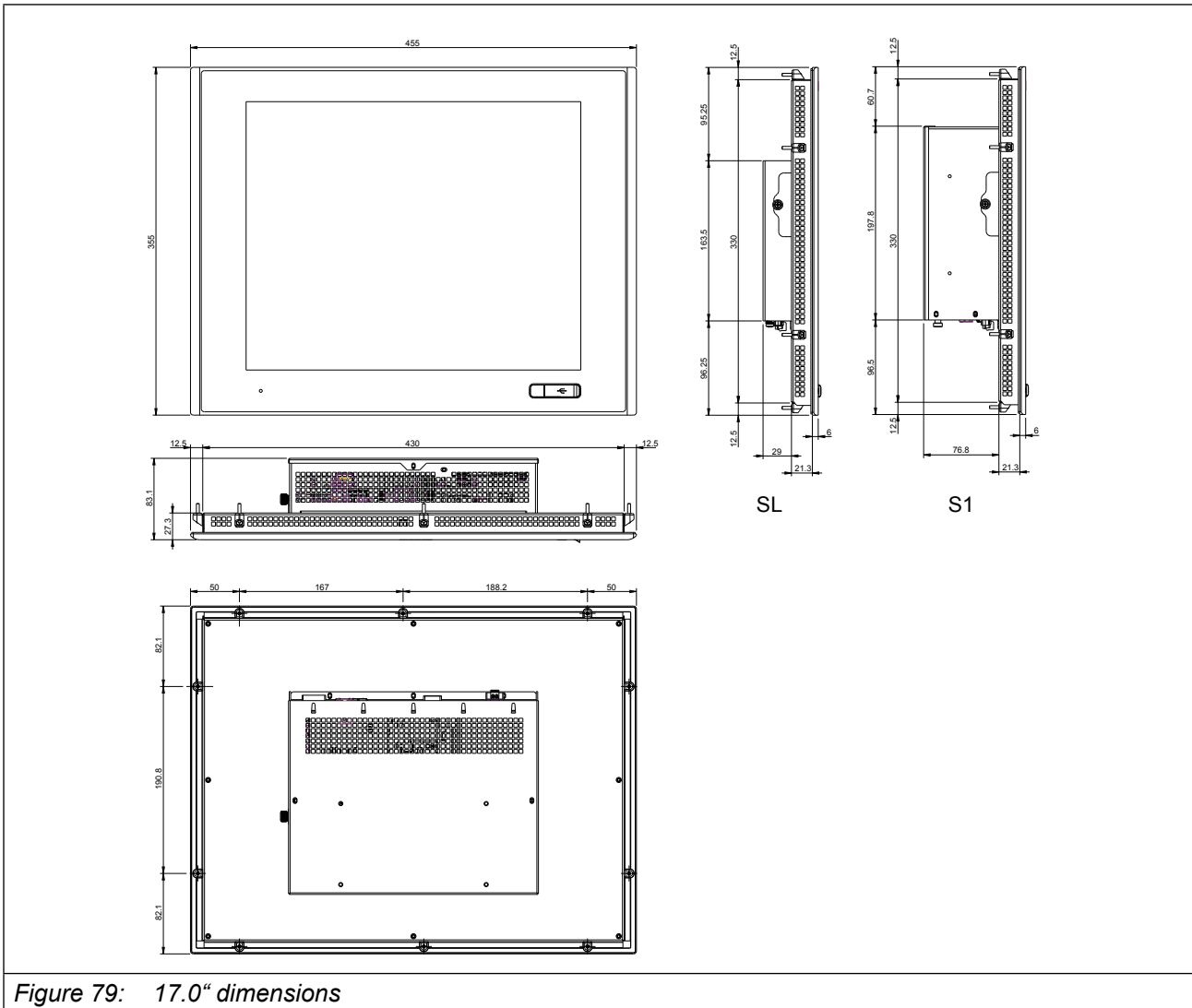
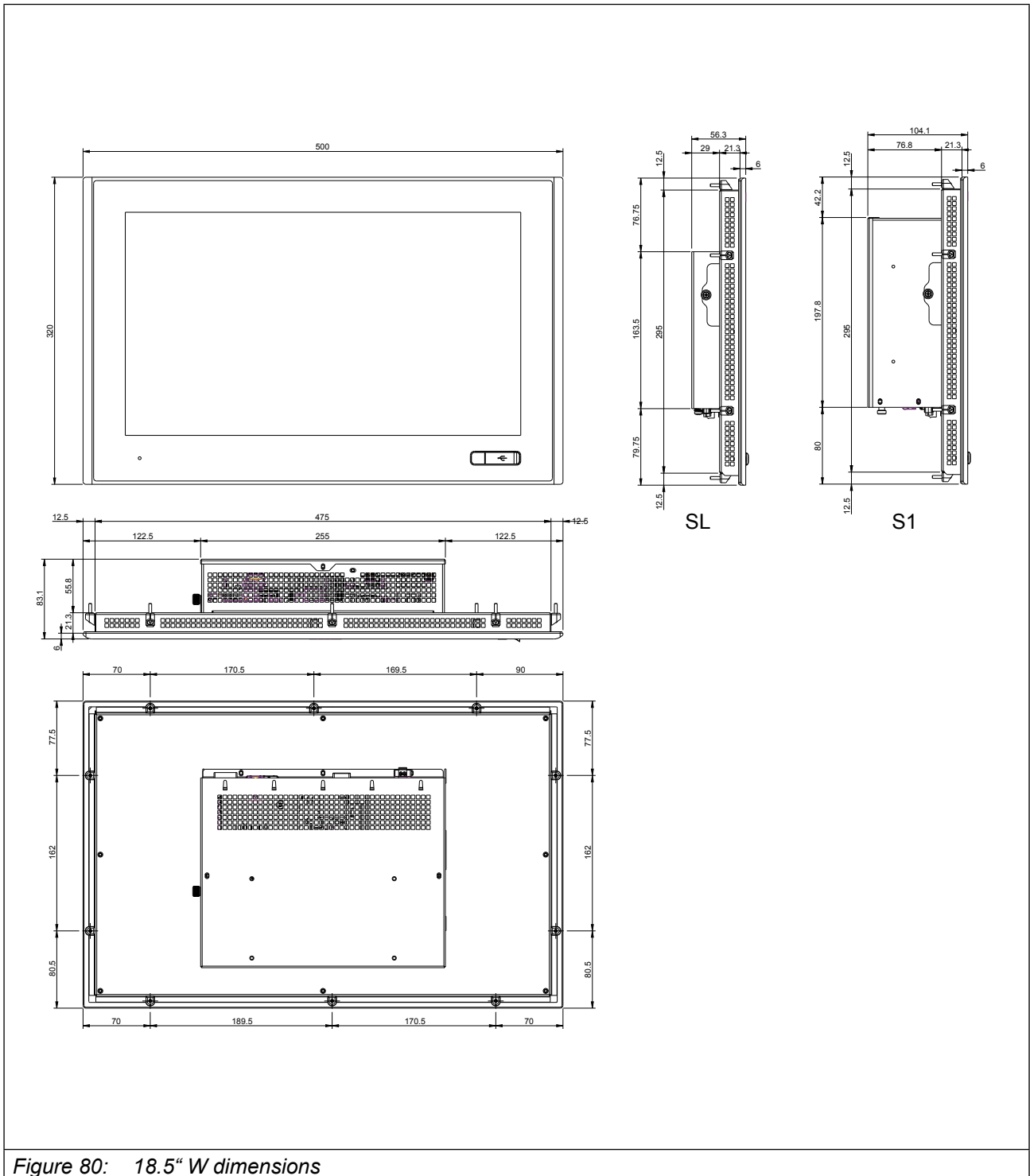

Figure 79: 17.0" dimensions

7.1.8 C6 E22 PANEL / SL-S1 / 18.5" W



7.1.9 C6 E22 PANEL / SL-S1 / 19.0"

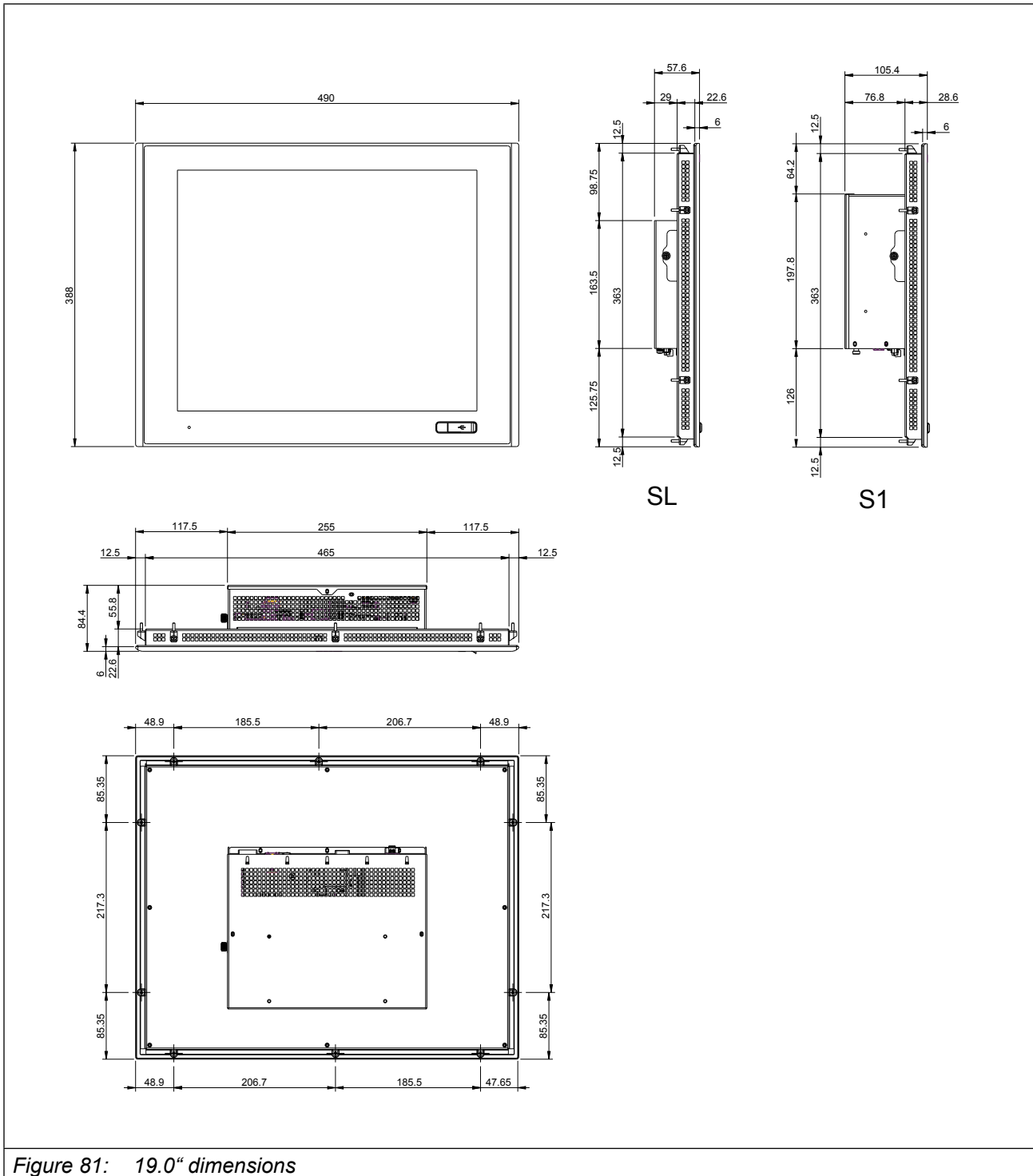

Figure 81: 19.0" dimensions

7.1.10 C6 E22 PANEL / SL-S1 / 21.5" W

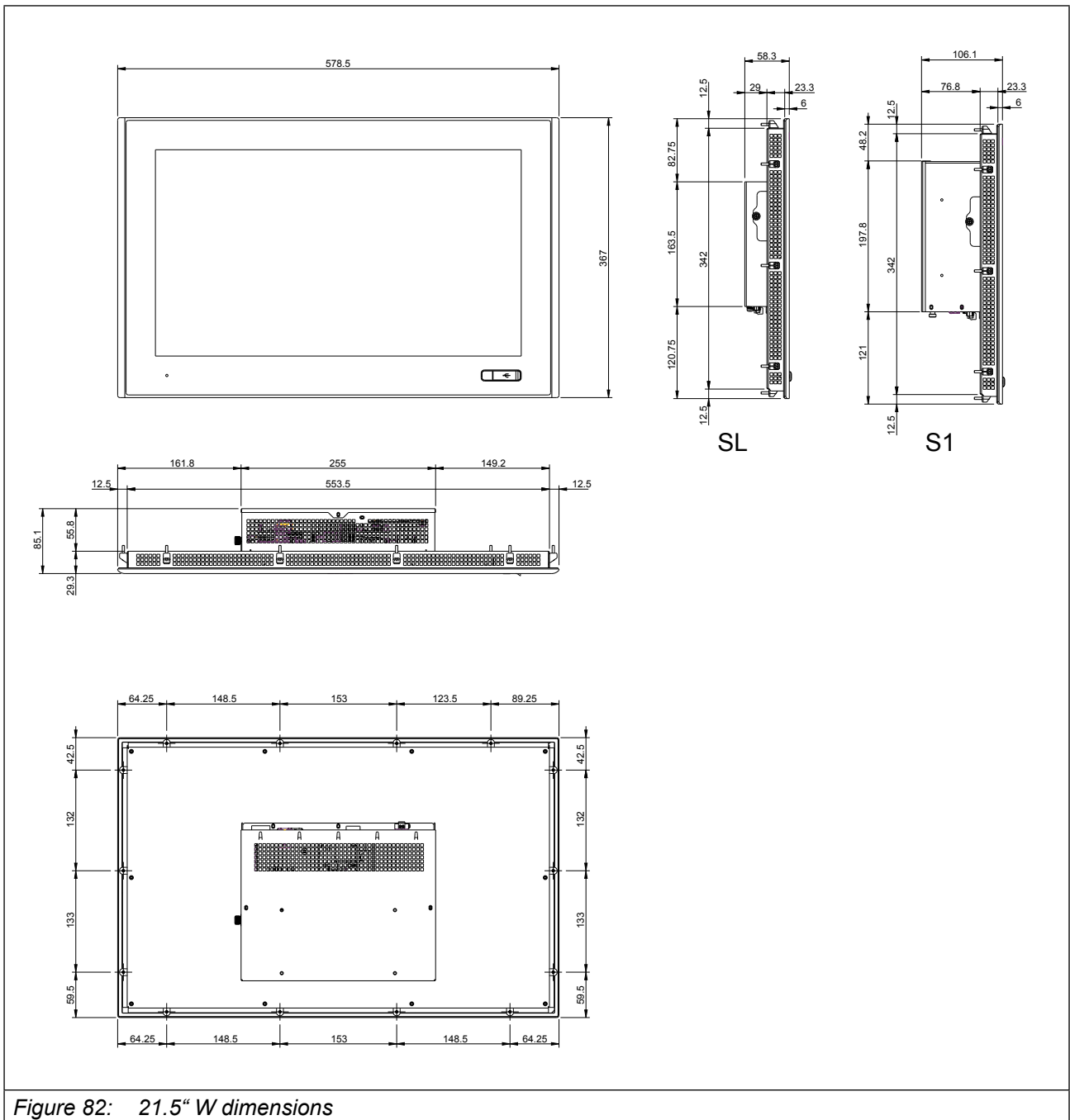

Figure 82: 21.5" W dimensions

7.1.11 C6 E22 PANEL / SL-S1 / 24.0" W

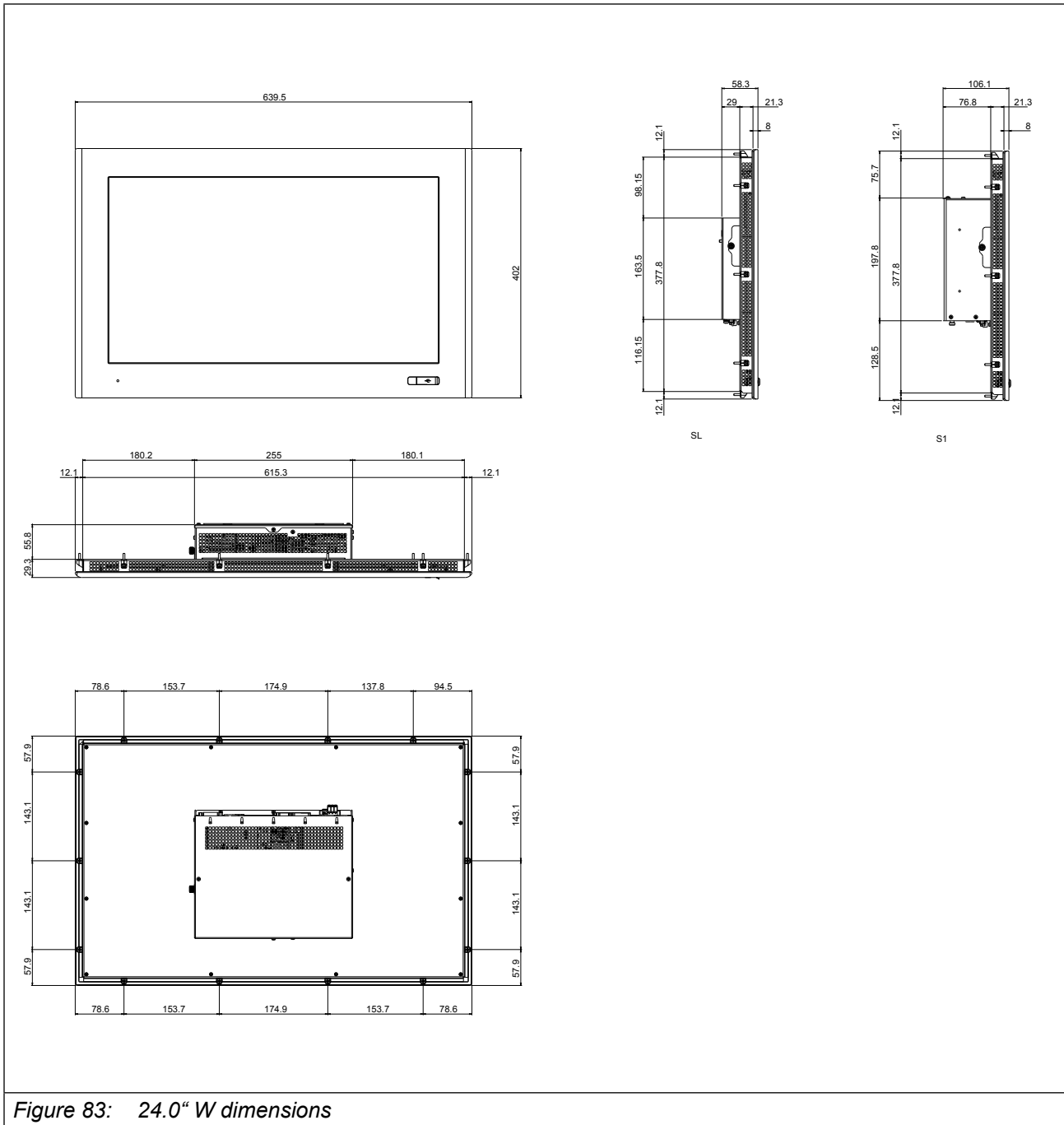

Figure 83: 24.0" W dimensions

7.1.12 C6 E22 Box SL-S1

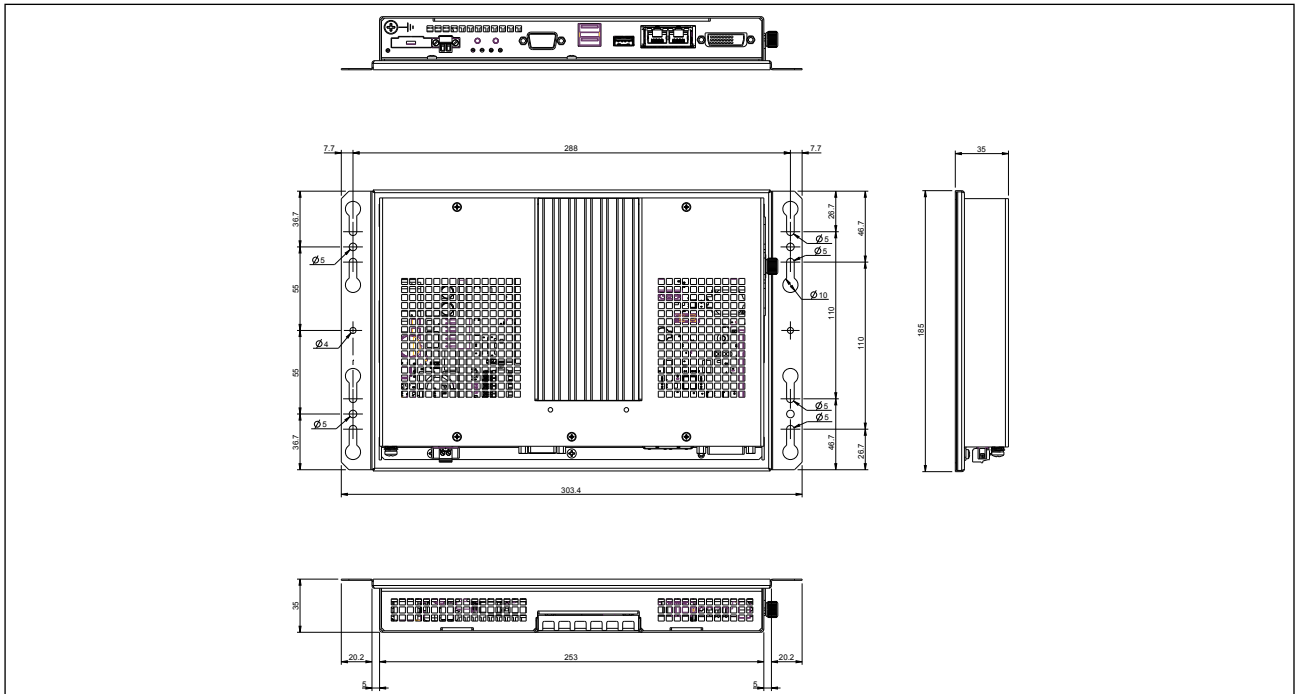

Figure 84: C6 E22 BOX SL

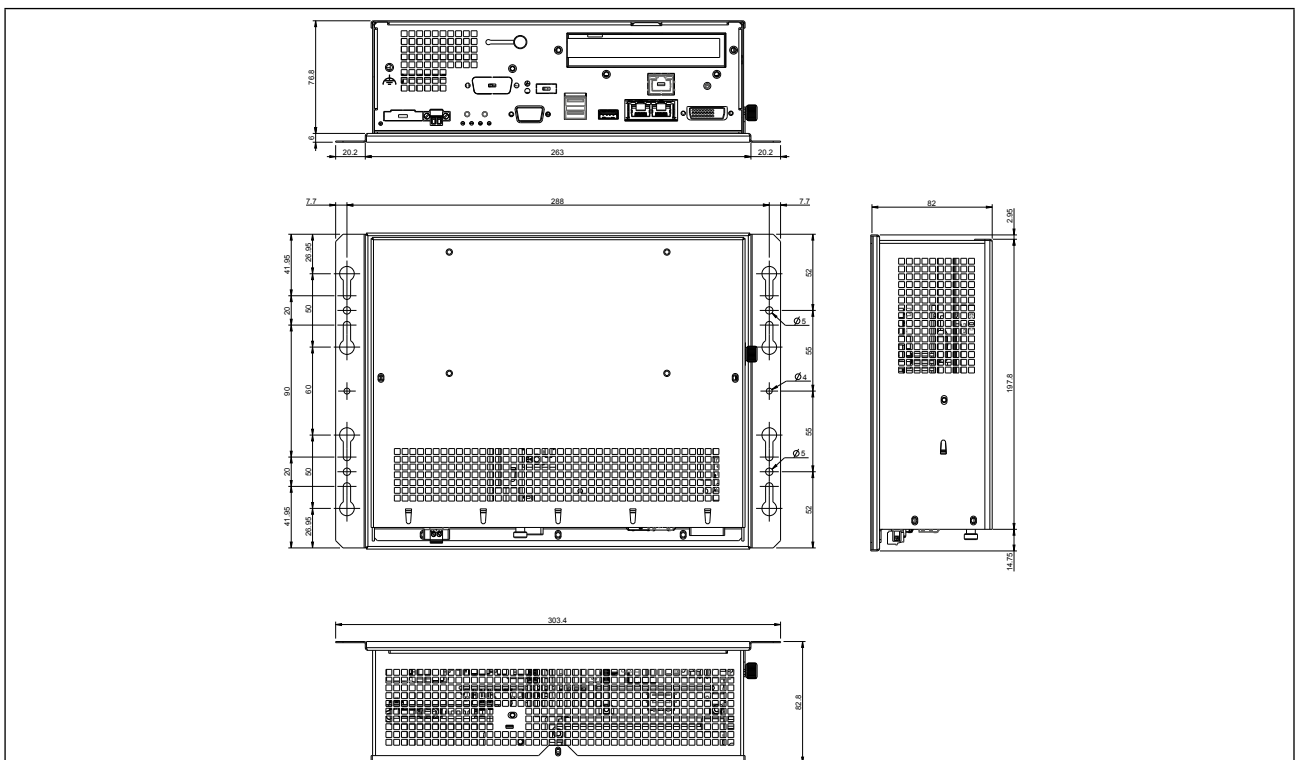
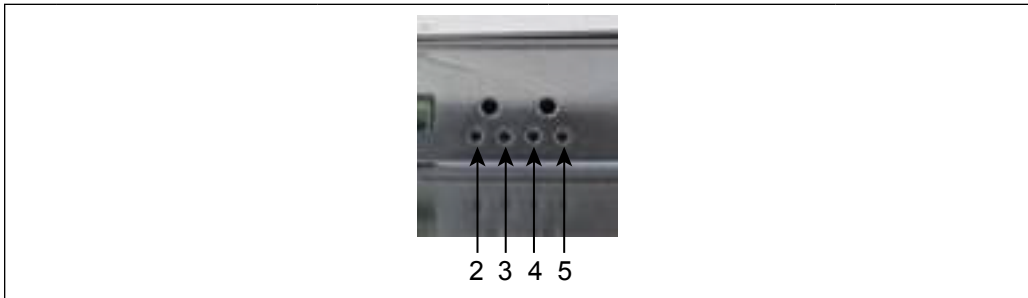

Figure 85: C6 E22 BOX S1

7.2 LED description



Figure 86: Details LED position



	LED reference	Color	Function	Ext. / int.
1	LED on the front side	Yellow/green	On/off Standby/μUSV	external
2	DL4	Red	Thermal warning	external
3	DL2	Red	Watchdog	external
4	DL3	Yellow	Mass storage device	external
5	DL1	Green	Power on / Standby	external
/	DL5	Green	Touchscreen	Internal

Figure 87: Details LED position

7.2.1 DL4 - Thermal LED Alarm

This LED is used to signal a thermal alarm of the C6 E22 BOX/PANEL. Two temperatures are measured with the Super I/O Nuvoto NCT6106D Hardware Monitor IC:

- CPU temperature on the motherboard.
- Motherboard temperature at ventilation input.

Measuring point	Max. permissible operating temperature
CPU	100°C
Motherboard	80°C

If this LED lights up, please switch off the system and check the cooling and power consumption.

7.2.2 Front LED - On/Off/UPS LED

This LED is used to provide information about the power status of the system.

System power status	Green	Yellow	Notes
OFF	OFF	OFF	The system is not powered.
ON	ON	OFF	System core is full.
μUPS	Blinking	OFF	System core is full. The main power supply is missing and μUPS supplies the system with power.

Table 20: Front LED - On/Off/UPS LED

DL1 and the green LED on the front have the same behavior.

7.2.3 DL2 - Watchdog LED

This LED indicates that the watchdog timer has expired. Depending on the JP jumper setting, also a system reset may or may not occur when the watchdog timer expires.

The DL4 LED can be reset to the OFF state by pressing the SW2 switch.

7.2.4 DL1 - Power on / Standby LED

System power status	Green	Yellow	Notes
OFF	OFF	OFF	The system is not powered.
ON	ON	OFF	System core is full.

Table 21: Power on / Standby LED

7.2.5 DL3 - Mass storage device LED

This LED lights up when mass storage devices (HDD, SSD, CF) are accessed via IDE channels (PATA or SATA).

7.2.6 LAN LED

There are two pairs of LEDs on the connector strip near the LAN ports. Each LED refers to a LAN port and provides information as shown in the following table.

LED reference	Color	Function		Ext. / int.
LED reference	Color	LAN	Function	Additional notes
LED SX	Green	LAN1 i210	Link/Activity	On: Connection established Blinking: Data transmission Off : no connection
LED DX	Yellow green	LAN1 i210	Speed	Yellow ON: 1Gbps Green steady light: 100Mbps Off : 10Mbps

Table 22: LAN LED

7.3 Key description

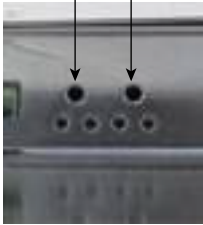

	Key reference	Function
1	SW1	Watchdog reset
2	SW3	System reset

Figure 88: Key position details

7.3.1 SW3 System reset key

This is the system main reset. Pressing this key resets the system status, starts the BIOS and then boots the operating system.
To reset the system, press the SW3 key once.

7.3.2 SW2 Watchdog reset key

This key is used to reset the watchdog LED (DL4) into the OFF state. The watchdog LED indicates that the watchdog timer has expired. Depending on the JP8 jumper setting, a system reset may or may not occur when the watchdog timer expires.
To reset the watchdog LED, please press the SW2 key once.

7.4 Description of the external connections

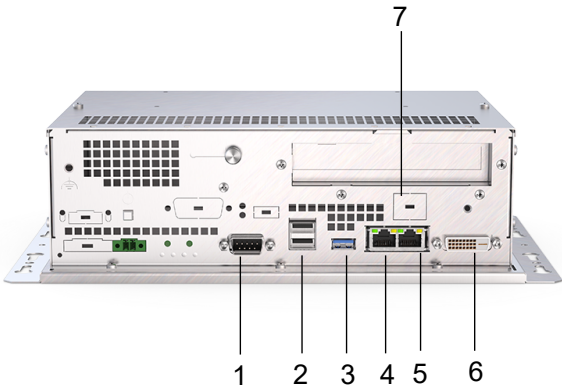
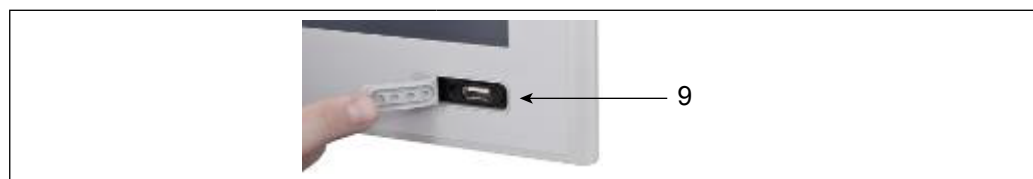

Figure 89: External connections



Figure 90: External connections



	Connection identification	Function
1	J2	COM 1 (RS232)
2	J3	USB (2.0)
3	J4	USB (3.0)
4	J6 SX	LAN 2 (10/100/1000 Mbps)
5	J6 DX	LAN 1 (10/100/1000 Mbps)
6	J7	DVI-I
7	J30	LAN 3 (10/100/1000 Mbps)
8	J22	CFAST
9	J31	USB 2.0 socket type A

Figure 91: Key position details

7.5 Technical support & repairs

KEB offers wide-ranging, complete after-sales technical support.

You can phone our staff in the service department, and they will give you complete, prompt advice on how to resolve your problems.

Phone: +49 05263 401 0

Fax: +49 05263 401 116

E-Mail: combicontrol@keb.de

8 Certificates and Approvals

8.1 EU Declaration of Conformity



EU KONFORMITÄTSERKLÄRUNG

Dokument-Nr. / Monat.Jahr: ce_ca_remv-C6H-b_de / 01.2019

Hersteller: KEB Automation KG
Südstraße 38
32683 BARNTRUP

Produktbezeichnung: Steuerungs-PC - Typenreihe yy**C6H**xx – xxxx
Größe yy = 00 für Stand Alone PC or
yy = 10 bis FF für TouchPanel PC
x = beliebiger Buchstabe oder Zahl
Spannungsklasse 24 Vdc

Das bezeichnete Produkt stimmt mit den Vorschriften folgender Europäischer Richtlinien überein:

Nummer: **EMV : 2014 / 30 / EU**
Text: Richtlinie des Rates zur Angleichung der Rechtsvorschriften der Mitgliedsstaaten über die elektromagnetische Verträglichkeit.

Nummer: **Gefährliche Substanzen: 2011 / 65 / EU (inkl. 2015 / 863 / EU)**
Text: Richtlinie des Rates zur Beschränkung der Verwendung bestimmter gefährlicher Stoffe in Elektro- und Elektronikgeräten.

CE

Weitere Angaben zur Einhaltung dieser Richtlinien enthält der Anhang.

Anbringung der CE-Kennzeichnung: ja

Aussteller: KEB Automation KG
Südstraße 38
32683 BARNTRUP

Ort, Datum Barntrup, 28.12.2018

Rechtsverbindliche Unterschrift:



 i. A. W. Hovestadt / Normenbeauftragter



 W. Wiele / Technischer Leiter

Die Anhänge sind Bestandteil dieser Erklärung.
Diese Erklärung bescheinigt die Übereinstimmung mit den genannten Richtlinien, beinhaltet jedoch keine Zusicherung von Eigenschaften.

Die Sicherheitshinweise der mitgelieferten Produktdokumentation sind zu beachten.

KEB Automation KG, Südstr. 38, D-32683 Barntrup www.keb.de E-Mail: info@keb.de Tel.: +49 5263 401-0 Fax: -116 Seite: 1 von 2

EU KONFORMITÄTSERKLÄRUNG



ANHANG 1

Dokument-Nr. / Monat.Jahr: ce_ca_remv-C6H-b_de / 01.2019

Produktbezeichnung: Steuerungs-PC - Typenreihe yy**C6H**xx – xxxx
 Größe yy = 00 für Stand Alone PC or
 yy = 10 bis FF für TouchPanel PC
 x = beliebiger Buchstabe oder Zahl
 Spannungs-kategorie 24 Vdc

Die Übereinstimmung des bezeichneten Produktes mit den Vorschriften der Richtlinie 2014/30/EU wird nachgewiesen durch die vollständige Einhaltung der folgend angegebenen Normen. Grundlage für die Bewertung ist eine typische Konfiguration mit Zubehör und Antriebssystemen. Für die Einhaltung der Grenzwerte ist die Beachtung der EMV - Installationshinweise notwendig.

Berücksichtigte harmonisierte Europäische Normen:

EN - Norm	Text	Referenz	Ausgabe
EN 55032 Ausgabe 2015	Elektromagnetische Verträglichkeit von Multimediageräten und – einrichtungen an die Störaussendung	VDE 0878 - 32	02 / 2016
EN 61000 – 3 – 2 Ausgabe 2014	EMV: Grenzwerte für Oberschwingungsströme für Eingangsstrom bis 16A je Leiter	VDE 0838 – 2	03 / 2015
EN 61000 – 3 – 3 Ausgabe 2013	EMV: Grenzwerte für Flicker für Eingangsstrom bis 16A je Leiter	VDE 0838 – 3	03 / 2014
EN 61000 – 6 – 2 Ausgabe 2005	Fachgrundnorm Störfestigkeit Teil 2: Industriebereich	VDE 0839 – 6 - 2	03 / 2006
EN 55024 Ausgabe 2010 + A1 aus 2015	Einrichtungen der Informationstechnik: Störfestigkeit Grenzwerte und Prüfverfahren	VDE 0878 - 24	05 / 2016

Die Übereinstimmung des bezeichneten Produktes mit den Vorschriften der Richtlinie 2011/65/EG und der Änderung über 2015/863/EU wird nachgewiesen durch die Qualifikation von Bauteilen und Fertigungsverfahren im Rahmen der durch die ISO 9001 vorgegebene Qualitätssicherung. Die entsprechenden Informationen und Beschreibungen sind dokumentiert und abgelegt.

Das bezeichnete Produkt wurde unter einem umfassenden Qualitätsmanagementsystem entwickelt, hergestellt und geprüft.

Die Konformität des Qualitätsmanagementsystems nach DIN ISO 9001 wurde bescheinigt durch:

Notifizierte Stelle: TÜV - CERT
 Anschrift: Zertifizierungsstelle des RWTÜV
 Steubenstrasse 53
 D - 45138 Essen

Nummer der Bescheinigung 041 004 500
 Aussteldatum: 20.10.14
 Gültig durch Nachprüfung bis: 12.2021

8.2 UL approval

	<p>Acceptance according to UL for KEB products is marked by the adjacent logo and the E-file number on the nameplate. The instructions given in this manual must be observed.</p>
---	---

<p>NRAQ.E479848 - Programmable Controllers UL Product iQ</p>	<p>https://iq.ulprospector.com/en/profile?e=86751</p>
<p>NRAQ.E479848 - Programmable Controllers Programmable Controllers</p>	
<p>See General Information for Programmable Controllers</p>	
<p>KEB AUTOMATION KG SUEDSTRASSE 38 32683 BARNTRUP, GERMANY</p>	<p>E479848</p>
<p>Investigated to ANSI/UL 508</p>	
<p>Front-Panel Mounting Display, for use on a flat surface of a type 1 and 4X INDOOR enclosure, Model(s) aaC6AF1-44xx Where "a" may be any character for different sizes of panel display. Where "xx" can be 02 or 05 representing SW Configuration.</p>	
<p>aaC6AF1-45xx Where "a" may be any character for different sizes of panel display. Where "xx" can be 02 or 05 representing SW Configuration.</p>	
<p>Open type, Programmable controllers Model(s) 00C6CB1-0100, 00C6CB1-0200, 00C6CB1-0300, 00C6CB1-0400, 00C6CB1-0500, 00C6CB1-0600, 00C6CB1-0700, 00C6CB1-0800, 00C6CB1-0900, 00C6CB1-1000, 00C6CB1-1100, 00C6CB1-1200, 00C6CB1-1300, 00C6CB1-1400, 00C6CB1-1600, 00C6CB1-1700, 00C6CB1-1800, 00C6CB1-1900, 00C6CB1-2000, 00C6CC1-0100, 00C6CC1-0200, 00C6CC1-0300, 00C6CC1-0400, 00C6CC1-0500, 00C6CC1-0700, 00C6CC1-0800, 00C6CC1-0900, 00C6CC1-1000, 00C6CC1-1100, 00C6CC1-1200, 00C6CC1-1300, 00C6CC1-1400, 00C6CC1-1500, 00C6CC1-1600, 00C6CC1-1700, 00C6CC1-1800, 00C6CC1-1900, 00C6CE1-0100, 00C6CE1-0200, 00C6CF1-0200, 00C6CH1-0100, 00C6HA1-xxxx, 00C6HB1-xxxx</p>	
<p>Programmable Controllers Model(s) 00C6CA1-0100 where xy may be 00,02,03,04,06,07,08,09 or 10.</p>	
<p>00C6CF1-0100 where xy may be 00,02,03,04,06,07,08,09 or 10.</p>	
<p>Programmable controllers Model(s) aaC6HA1-xxxx Where "a" may be any character for different sizes of panel display.</p>	
<p>aaC6HB1-xxxx Where "a" may be any character for different sizes of panel display.</p>	
<p>Investigated to UL 61010-1 and UL 61010-2-201</p>	
<p>Programmable Automation Controller, PAC Model(s) C6 Smart, xxC6Gxx-xxxx</p>	
<p>Investigated to UL 61010-1, 3rd Edition and UL 61010-2-201, 1st Edition</p>	
<p>Front-Panel Mounting or Open type Industrial PC Model(s) 00C6HM1-xxxx Where "xxxx" is a 4 digit / letter combination for different software configurations.</p>	
<p>00C6HN1-xxxx Where "xxxx" is a 4 digit / letter combination for different software configurations.</p>	
<p>aaC6HM1-xxxx Where "a" may be any character for different sizes of panel display. Where "xxxx" is a 4 digit / letter combination for different software configurations.</p>	
<p>aaC6HN1-xxxx Where "a" may be any character for different sizes of panel display. Where "xxxx" is a 4 digit / letter combination for different software configurations.</p>	
<p>Industrial PC Model(s) 00C6HL1-xxxx Where "xxxx" is a 4 digit / letter combination for different software configurations.</p>	
<p>Industrial PC Model(s) 00C6HP1-xxxx Where "xxxx" is a 4 digit / letter combination for different software configurations.</p>	
<p>00C6HQ1-xxxx Where "xxxx" is a 4 digit / letter combination for different software configurations.</p>	
<p>Programmable controllers Model(s) aaC6JF1-110x Where "a" may be any character for different sizes of panel display. Where "x?" is any digit representing Customer ID.</p>	
<p>aaC6JF1-111x Where "a" may be any character for different sizes of panel display. Where "x?" is any digit representing Customer ID.</p>	
<p>aaC6JF1-112x Where "a" may be any character for different sizes of panel display. Where "x?" is any digit representing Customer ID.</p>	
<p>Investigated to UL 61010-1, 3rd Edition and UL 61010-2-201, 2nd Edition</p>	
<p>Programmable Controllers, "Multi Fieldbus Interface C6 Remote I/OS" Model(s) 00C6CH1-0200, 00C6CH1-0300, 00C6CH1-0400, 00C6CH1-0500</p>	
<p>Investigated to</p>	
<p>Industrial PC Model(s) 00C6HC1-xxxx</p>	
<p>Last Updated on 2020-03-11</p>	
<p>The appearance of a company's name or product in this database does not in itself assure that products so identified have been manufactured under UL's Follow-Up Service. Only those products bearing the UL Mark should be considered to be Certified and covered under UL's Follow-Up Service. Always look for the Mark on the product.</p>	
<p>UL permits the reproduction of the material contained in the Online Certification Directory subject to the following conditions: 1. The Guide Information, Assemblies, Constructions, Designs, Systems, and/or Certifications (files) must be presented in their entirety and in a non-misleading manner, without any manipulation of the data (or drawings). 2. The statement "Reprinted from the Online Certifications Directory with permission from UL" must appear adjacent to the extracted material. In addition, the reprinted material must include a copyright notice in the following format: "© 2020 UL LLC"</p>	
<p>2 von 2</p>	<p>08.07.2020, 14:54</p>

8.3 RoHS Declaration of Conformity

	<p>In accordance with: EN 50581: Technical documentation for the assessment of electrical and electronic equipment with regard to the restriction of dangerous substances RoHS Directive 2011/65/EU</p>
---	---

Austria | KEB Automation GmbH
Ritzstraße 8 4614 Marchtrenk Austria
Tel: +43 7243 53586-0 Fax: +43 7243 53586-21
E-Mail: info@keb.at Internet: www.keb.at

Benelux | KEB Automation KG
Dreef 4 - box 4 1703 Dilbeek Belgium
Tel: +32 2 447 8580
E-Mail: info.benelux@keb.de Internet: www.keb.de

Brazil | KEB South America - Regional Manager
Rua Dr. Omar Pacheco Souza Riberio, 70
CEP 13569-430 Portal do Sol, São Carlos Brazil
Tel: +55 16 31161294 E-Mail: roberto.arias@keb.de

Czech Republic | KEB Automation GmbH
Videnska 188/119d 61900 Brno Czech Republic
Tel: +420 544 212 008
E-Mail: info@keb.cz Internet: www.keb.cz

France | Société Française KEB SASU
Z.I. de la Croix St. Nicolas 14, rue Gustave Eiffel
94510 La Queue en Brie France
Tel: +33 149620101 Fax: +33 145767495
E-Mail: info@keb.fr Internet: www.keb.fr

Germany | Geared Motors
KEB Antriebstechnik GmbH
Wildbacher Straße 5 08289 Schneeberg Germany
Telefon +49 3772 67-0 Telefax +49 3772 67-281
Internet: www.keb-drive.de E-Mail: info@keb-drive.de

Italy | KEB Italia S.r.l. Unipersonale
Via Newton, 2 20019 Settimo Milanese (Milano) Italia
Tel: +39 02 3353531 Fax: +39 02 33500790
E-Mail: info@keb.it Internet: www.keb.it

Japan | KEB Japan Ltd.
15 - 16, 2 - Chome, Takanawa Minato-ku Tokyo 108 - 0074 Japan
Tel: +81 33 445-8515 Fax: +81 33 445-8215
E-Mail: info@keb.jp Internet: www.keb.jp

P. R. China | KEB Power Transmission Technology (Shanghai) Co. Ltd.
No. 435 QianPu Road Chedun Town Songjiang District
201611 Shanghai P.R. China
Tel: +86 21 37746688 Fax: +86 21 37746600
E-Mail: info@keb.cn Internet: www.keb.cn

Poland | KEB Automation KG
Tel: +48 60407727
E-Mail: roman.trinczek@keb.de Internet: www.keb.de

Republic of Korea | KEB Automation KG
Deoksan-Besttel 1132 ho Sangnam-ro 37
Seongsan-gu Changwon-si Gyeongsangnam-do Republic of Korea
Tel: +82 55 601 5505 Fax: +82 55 601 5506
E-Mail: jaeok.kim@keb.de Internet: www.keb.de

Spain | KEB Automation KG
c / Mitjer, Nave 8 - Pol. Ind. LA MASIA
08798 Sant Cugat Sesgarrigues (Barcelona) Spain
Tel: +34 93 8970268 Fax: +34 93 8992035 E-Mail: vb.espana@keb.de

Switzerland | KEB Automation AG
Witzbergstrasse 24 8330 Pfaeffikon/ZH Switzerland
Tel: +41 43 2886060 Fax: +41 43 2886088
E-Mail: info@keb.ch Internet: www.keb.ch

United Kingdom | KEB (UK) Ltd.
5 Morris Close Park Farm Industrial Estate
Wellingborough, Northants, NN8 6 XF United Kingdom
Tel: +44 1933 402220 Fax: +44 1933 400724
E-Mail: info@keb.co.uk Internet: www.keb.co.uk

United States | KEB America, Inc
5100 Valley Industrial Blvd. South
Shakopee, MN 55379 United States
Tel: +1 952 2241400 Fax: +1 952 2241499
E-Mail: info@kebameric.com Internet: www.kebameric.com



MORE KEB PARTNERS WORLDWIDE:

... www.keb.de/contact/contact-worldwide



Automation with Drive

www.keb.de

KEB Automation KG Suedstrasse 38 32683 Barntrup Tel. +49 5263 401-0 E-Mail: info@keb.de