



KEB AUTOMATION SYSTEMS

INSTRUCTIONS FOR USE | C6 S14

Translation of original manual
Document 20196812 EN 03



Content

1	Preliminary Information	1
1.1	General notes	2
1.2	Trademarks.....	2
1.3	Instructions on disposal	2
1.4	Description of the safety symbols.....	3
1.5	Qualified Personnel	4
1.6	Basic knowledge required	4
1.7	Proper use of the product	4
1.8	Purpose of the user's guide	4
1.9	The manual is a part of the system	4
1.10	Figures.....	4
1.11	Scope of the operating instructions	5
1.12	Safety instructions	6
1.12.1	Installation according to the instructions	6
1.12.2	Working on the control cabinet.....	6
1.13	Notes about usage	6
1.14	Applicable standard	6
2	Description	7
2.1	Product description.....	8
2.1.1	C6 S14 (with μ UPS) description.....	8
2.1.2	C6 S14 (with μ USV) performance features	9
2.2	Package	10
2.3	Front panels.....	11
2.3.1	Full aluminium front panel	12
2.3.2	Capacitive front panel	14
2.3.3	LCD aspect ratio	15
2.4	Rear view.....	16
2.5	Side view	16
2.6	Connector view.....	17
2.6.1	Labels.....	18
2.6.2	μ UPS.....	19
2.7	Putting in operation.....	20
2.7.1	Configuration and project creation	20
2.7.2	Process management	20
3	Installation and connection	21
3.1	Preparation for installation	22
3.1.1	Select the mounting location	22
3.1.2	Portrait Mounting	22
3.2	Checking the package contents	22
3.3	Checking the operating conditions	22
3.4	Mounting position	23
3.4.1	Damage due to overheating	23
3.5	Checking installation distances.....	24
3.6	Preparing the mounting cut-out	24
3.6.1	Degrees of protection.....	24
3.6.2	Cut-out measures.....	25
3.7	Mounting the device	26
3.7.1	Position of the mounting clamps	26
3.7.2	Tools to tighten the mounting clamps.....	26
3.7.3	Procedure	27
3.8	Connecting the device.....	30
3.8.1	Notes on connection	30
3.8.2	Power supply connection	30
3.8.3	Switching on and testing the device.....	31
3.9	Connecting the configuration PC	32
4	Commissioning the device	35
4.1	Storage.....	36
4.2	Slot for memory card	37
4.3	Installation/removal of a memory card	37
5	Commissioning a project	39
5.1	COMBIVIS studio HMI project	40
5.1.1	Overview	40
5.1.2	Transfer	40
5.1.3	Configuration of the serial port.....	40
5.1.4	Connecting the serial port	42

5.1.5	Managing the project	43
5.1.6	Stopping the running project	44
5.1.7	Starting the project	45
5.1.8	Debugging the project	46
5.1.9	Transfer the project from C6 S14 to the configuration PC	48
5.1.10	Backup and restore	49
5.1.11	Updating the operating system	49
5.2	COMBIVIS studio 6 BASIC/PRO/ADVANCED	50
5.2.1	Project Implementation	50
5.2.2	Transferring the COMBIVIS studio 6 application to the target system	51
5.2.3	I/O Fieldbus	52
5.2.4	Support for retentive data	52
5.2.5	Use in combination with COMBIVIS HMI Runtime	56
5.2.6	Use in combination with COMBIVIS connect	58
5.2.7	Limitations and Recommendations	59
6	System Manager	60
6.1	System Manager	61
6.1.1	Backup Restore	62
6.1.2	System clone and restore	62
6.1.3	Font Antialiasing	65
6.1.4	EMMC Usage	66
6.1.5	Kiosk Mode	67
6.1.6	Language Settings	68
6.1.7	Scrollbar	69
6.1.8	System Reboot	69
6.1.9	Assign network settings via text file to the USB stick	69
7	Maintenance and care	70
7.1	Calibration of the touchscreen	71
7.2	Maintaining & cleaning	72
7.2.1	Procedure	72
7.2.2	Removing the rear cover for access to the motherboard	73
7.2.3	Backup battery replacement (BR2032 3V)	75
7.2.4	Micro UPS Backup battery replacement	76
8	Technical specifications	78
8.1	Technical specifications	79
8.1.2	C6 S14 resistive	80
8.1.3	C6 S14 capacitive	81
8.1.4	C6 S14 Family Technical specifications	82
8.1.5	CONTROL Runtime WinCE/ARM for C6 S14 main features	83
8.1.6	COMBIVIS HMI runtimes differences	83
8.1.7	COMBIVIS CONNECT PRO main features	83
8.1.8	KEB System Manager Control Panel utilities	83
8.1.9	7.0" W Display characteristics	84
8.1.10	8.4" Display characteristics	84
8.1.11	10.1" Display characteristics	84
8.1.12	10.1" W Display characteristics	85
8.1.13	10.4" Display characteristics	85
8.1.14	12.1" (SVGA) Display characteristics	85
8.1.15	12.1" W (WXGA) Display characteristics	86
8.1.16	15.0" (XGA) Display characteristics	86
8.1.17	15.6" W (WXGA) Display characteristics	87
8.2	Certificates and approvals	88
8.3	Dimension drawings	91
8.3.1	7.0" W (resistive)	91
8.3.2	7.0" W capacitive CUTOOUT B	93
8.3.3	8.4" (resistive)	95
8.3.4	10.1" W (resistive)	97
8.3.5	C6 S14 - 10.1" W (capacitive)	99
8.3.6	10.4" (resistive)	101
8.3.7	12.1" (resistive)	103
8.3.8	12.1" W (resistive)	105
8.3.9	12.1" W (capacitive)	107
8.3.10	15.0" (resistvie)	109
8.3.11	15.6" W (resistive)	111
8.3.12	15.6" W (capacitive)	113
8.4	Ports PINOUT	115
8.4.1	COM1	115
8.4.2	LAN1 – LAN2	115

8.4.3	CAN	115
8.4.4	RS485.....	116
8.4.5	USB1 / USB2.....	116
8.5	Technical support & repairs.....	116
8.6	Recycling and disposal	116

SECTION **1**

**Preliminary
Information**

1.1 General notes

- a) The information in this manual is subject to change and is in no way binding upon KEB Automation KG
- b) KEB Automation KG is not responsible for technical errors or other omissions in the manual, and shall not accept any responsibility deriving from its use.

1.2 Trademarks

- a) All brands and product names mentioned in this manual are trademarks of their respective owners.

1.3 Instructions on disposal

DE



- Das Symbol  auf dem Produkt oder seiner Verpackung weist darauf hin, dass dieses Produkt nicht als normaler Haushaltsabfall zu behandeln ist, sondern an einem Sammelpunkt für das Recycling von elektrischen und elektronischen Geräten abgegeben werden muss. Durch ihren Beitrag zum korrekten Entsorgen dieses Produkts schützen Sie die Umwelt und die Gesundheit Ihrer Mitmenschen. Umwelt und Gesundheit werden durch falsches Entsorgen gefährdet. Weitere Informationen über das Recycling dieses Produkts erhalten Sie von Ihrem Rathaus, Ihrer Müllabfuhr oder den Distributoren, in dem Sie das Produkt gekauft haben.

EN



- The symbol  on the product or in its packaging indicates that this product may not be treated as household waste. Instead it shall be handed over the applicable collection point for the recycling of electrical and electronic equipment. By ensuring this product is disposed of correctly, you will help prevent potential negative consequences for the environment and human health, which could otherwise be caused by inappropriate waste handling of this product. For more detailed information about recycling of this product, please contact your local city office, your household waste disposal service or the supplier where you purchased the product.

IT



- Il simbolo  sul prodotto o sulla confezione indica che il prodotto non deve essere considerato come un normale rifiuto domestico, ma deve essere portato nel punto di raccolta appropriato per il riciclaggio di apparecchiature elettriche ed elettroniche. Provvedendo a smaltire questo prodotto in modo appropriato, si contribuisce a evitare potenziali conseguenze negative per l'ambiente e la salute, che potrebbero derivare da uno smaltimento inadeguato del prodotto. Per informazioni più dettagliate sul riciclaggio di questo prodotto, contattare l'ufficio comunale, il servizio locale di smaltimento rifiuti o il fornitore da cui è stato acquistato il prodotto.

FR



- Le symbole  sur le produit ou son emballage indique que ce produit ne peut être traité comme déchet ménager. Il doit être remis au point de collecte dédié à cet effet (collecte et recyclage du matériel électrique et électronique). En procédant à la mise à la casse réglementaire de l'appareil, nous préservons l'environnement et notre sécurité, s'assurant ainsi que les déchets seront traités dans des conditions appropriées. Pour obtenir plus de détails sur le recyclage de ce produit, veuillez prendre contact avec les services de votre commune ou le distributeur où vous avez effectué l'achat.

ES





- El símbolo  en el producto o en su embalaje indica que este producto no se puede tratar como desperdicios normales del hogar. Este producto se debe entregar al punto de recolección de equipos eléctricos y electrónicos para reciclaje. Al asegurarse de que este producto se desecha correctamente, usted ayudará a evitar posibles consecuencias negativas para el ambiente y la salud pública, lo cual podría ocurrir si este producto no se manipula de forma adecuada. Para obtener informaciones más detalladas sobre el reciclaje de este producto, póngase en contacto con la Administración de su ciudad, con su servicio de desechos del hogar o con el surtidor donde compró el producto.

PT



- Simbolo  no produto ou na embalagem indica que este produto não pode ser tratado como lixo doméstico. Em vez disso, deve ser entregue ao centro de recolha selectiva para a reciclagem de equipamento eléctrico e electrónico. Ao garantir uma eliminação adequada deste produto, irá ajudar a evitar eventuais consequências negativas para o meio ambiente e para a saúde pública, que, de outra forma, poderiam ser provocadas por um tratamento incorrecto do produto. Para obter informações mais detalhadas sobre a reciclagem deste produto, contacte os serviços municipalizados locais, o centro de recolha selectiva da sua área de residência ou no distribuidor onde adquirir o produto.

1.4 Description of the safety symbols

 Danger	This symbol indicates a danger to life or health of personnel.
 Attention	This symbol indicates a danger to the hardware and / or the environment.
 Note	This symbol indicates an additional information meant to provide a better understanding.

1.5 Qualified Personnel

- a) The system may be operated only by personnel qualified for the specific task in accordance with the relevant documentation for the specific task, in particular its warning notices and safety instructions.
- b) Qualified personnel are those who, based on their training and experience, are able to identify risks and avoid potential hazards when working with these systems.

1.6 Basic knowledge required

- a) To understand operating instructions a general knowledge of automation technology is needed.
- b) Knowledge of personal computers and the Microsoft operating system is required to understand this user's guide.

1.7 Proper use of the product

- a) KEB products may only be used for the applications described in the catalogue and in the technical documentation.
- b) If products and components from other manufacturers are used, these must be approved by KEB.
- c) Proper transport, assembly, installation, storage, commissioning, operation and maintenance are required to ensure that the product operates safely.
- d) The indicated environmental conditions must be observed.
- e) The information in this user's manual must be observed.

1.8 Purpose of the user's guide

- a) This user's manual contains information based on the requirements defined by DIN EN 62079 for mechanical engineering documentation.
- b) These operating instructions are intended for:
 - 1. Users.
 - 2. Commissioning engineers.
 - 3. Maintenance personnel.
- c) Pay attention at the information in the chapter "Safety instructions".
- d) More information such as operating instructions, examples and reference information, are available in the online help of COMBIVIS studio HMI software and COMBIVIS connect software.

1.9 The manual is a part of the system

- a) This operating instruction belongs to the system and is also required for commissioning.
- b) Keep all supplied documentation for the entire service life of the system.

1.10 Figures

- a) This manual contains illustrations of the described devices.
- b) Some details of the illustrations may differ from the device provided.

1.11 Scope of the operating instructions

The operating instructions apply to the C6 S14 family devices.

The devices are the following:

C6 S14 resistive	7.0" W	Full aluminium front panel
	8,4"	
	10.1" W	
	10.4"	
	12.1"	
	12.1" W	
	15.0"	
	15.6" W	
C6 S14 capacitive	7.0" W	Aluminium and glass front panel with True-Flat technology with multitouch touchscreen
	10.1" W	
	12.1" W	
	15.6" W	

1.12 Safety instructions

1.12.1 Installation according to the instructions

- Commissioning the device is prohibited until it has been absolutely ensured that the system in which the device is to be installed complies with all the applicable EU and international regulation.

1.12.2 Working on the control cabinet

- **Open equipment**
The device is open equipment. This means that the system may only be integrated in housings or cabinets, where it can be operated from the front panel. The cabinet in which the system is installed may only be accessed with a key or tool and only by trained and authorized personnel.
- **Dangerous voltage**
Opening the cabinet may expose high voltage parts. Before opening the cabinet always disconnect the power.

1.13 Notes about usage

- The system is approved for indoor use only.
- The system may be damaged if operated outdoors.

1.14 Applicable standard

Please refer section system manager for details about the relevant standards.

SECTION **2**

Description

2.1 Product description

2.1.1 C6 S14 (with μ UPS) description

C6 S14 ARM-based Panel PACs - Programmable Automation Controllers - combine visualization, control and remote assistance functions.

They integrate the numerous and advanced functions of COMBIVIS HMI Runtime, in Basic or Advanced versions, Control Runtime, in Basic, Pro and Advanced and COMBIVIS connect and KEB COMBIVIS CONNECT Remote Assistance Software with Windows Embedded Compact 7 Pro. C6 S14 panels are available with a wide range of colours of 16 million colors LED backlight in TFT LCD sizes with aluminum (resistive touchscreen), aluminum true flat (resistive touchscreen) or aluminum true flat multitouch front panel (glass projected capacitive touchscreen).

C6 S14 systems are based on the ARM Cortex A9 1.0 GHz processor (NXP i.MX6 Duallite or QuadPlus) with 1 GB system RAM (DDR3-1600/800), 4 GB eMMC pseudo-SLC memory, a slot for a removable MicroSD memory card and 512kb MRAM memory (Magnetoresistive RAM) for remanent data storage at power down to be used in combination with the MicroUPS (removable).

The motherboard includes the isolated 24 VDC power supply, two 10/100/1000 Mbps Ethernet interfaces, an RS-232/422/485 configurable serial port with MPI protocol support and two USB interfaces.

C6 S14, optionally, can be supplied with an isolated CAN interface or an additional isolated RS-485 serial port.

2.1.2 C6 S14 (with μ USV) performance features

- CONTROL Runtime (WinCE) in the versions Basic, Pro and Advanced.
- COMBIVIS HMI Runtime (WinCE) in the versions Basic and Advanced.
- COMBIVIS connect (WinCE) in the version Pro.
- Windows Embedded Compact 7 Pro operating system with Datalight Reliance Nitro file system.
- NXP® ARM Cortex A9 i.MX6 1.00 GHz DualLite processor.
- Front panel available in two variants: aluminium and aluminium TrueFlat with P-CAP Multi-touch.
- Wide range of TFT LCD 16 mln colors and LED backlight displays:
 - 4:3 aspect ratio: 8.4", 10.4", 12.1", 15".
 - Wide aspect ratio: 7" W (15:9), 10.1" W (16:10), 12.1" W (16:10), 15.6" W (16:9).
- Smart Memory System:
 - 1 GB RAM DDR3.
 - 4 GB eMMC (SSD Pseudo-SLC).
 - 512 kB MRAM (magnetoresistive RAM).
 - 1 MicroSD slot.
- Interfaces:
 - 2 x Ethernet 10/100/1000 Mbps.
 - 2 x USB 2.0.
 - 1 x RS232/422/485 (DM15M) with MPI/PPI protocol support.
 - Optional add-on (only one):
 - 1 x RS485 isolated (DB9M).
 - 1 x CAN RAW isolated (DB9M).
- Isolated 24V DC power supply input with integrated MicroUPS to save remanent variables on 512 kB MRAM memory.

2.2 Package

C6 S14 package consists of:

C6 S14 system		C6 S14
Quick guide		X
Clamps with grub screw (depending of the LCD size)		X
n.1 hex key 1.5mm		X
n.1 Power supply plug		X

2.3 Front panels

The system is available with two different kinds of **frontal panel**:

- Full aluminium (resistive).
- Aluminium with True Flat technology and Multi-touch (capacitive).

Figure 1
Full aluminium resistive front panel details



Figure 2
Capacitive front panel details



2.3.1 Full aluminium front panel

C6 S14 (full aluminium front panel) is available in the following sizes:

- 7.0" W
- 8.4"
- 10.1" W
- 10.4"
- 12.1"
- 12.1" W
- 15.0"
- 15.6" W

Figure 3
Full aluminium front panel detail
(in the figure is shown as an example a
15.0" display)



- ① Full aluminium front panel
- ② Touchscreen display

- The full aluminium front panel has a "step" between the front panel and the touch screen.

Figure 4
Front panel "Step" detail

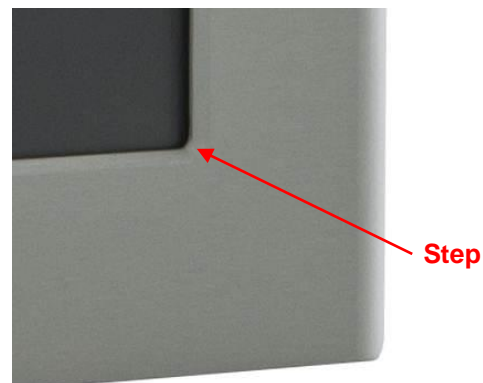
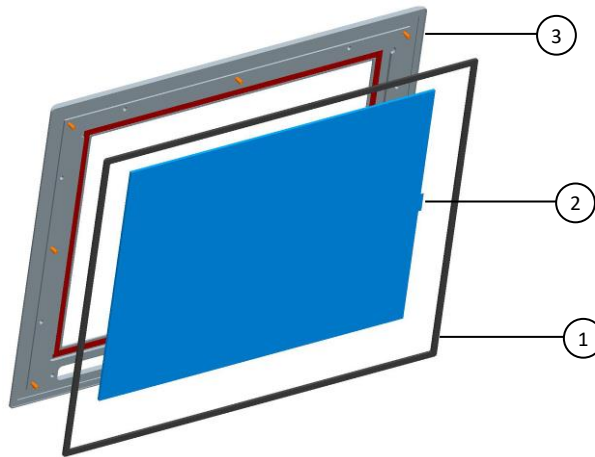

Table 1
Full aluminium features

Features	
Index of protection	IP66
Back Seal type	EPDM
Metal housing	EN AW-5754, H22 EN 485-1

Figure 5
Construction detail



①	Back seal
②	Touchscreen
③	Metal housing

2.3.2 Capacitive front panel

Capacitive C6 S14 (aluminium and glass front panel with True Flat technology with Multi-touch touch screen) is available in the following sizes:

- 7.0" W
- 10.1" W
- 12.1" W
- 15.6" W



Figure 6
Front Panel capacitive (the figure shows a 15.6" display as an example)

①	Aluminium and tempered glass TrueFlat
②	Projective capacitive multitouch

The front panels with True Flat technology contain a projective capacitive multi-touch touchscreen operated by a USB controller in the system.

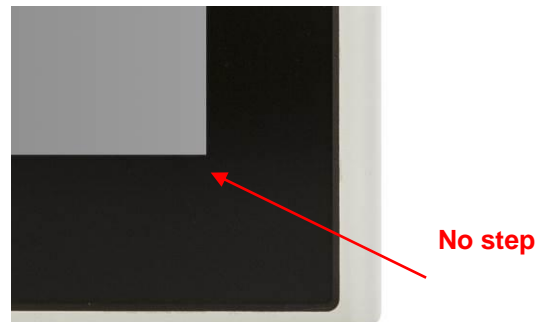
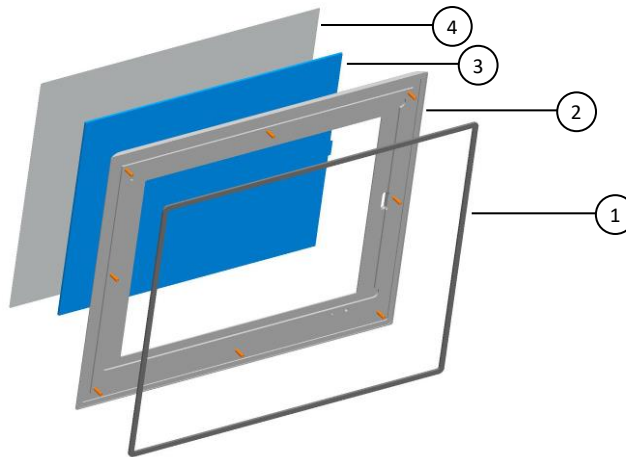

Figure 7
Front Panel capacitive "No Step" details

Table 2
Capacitive features

Features	
Index of protection	IP66K
Seal type	EPDM
Front laminate	Glass
Metal housing	Aluminium alloy 5754

Figure 8
Construction details



①	Back seal
②	Metal housing
③	Touchscreen
④	Cover glass

2.3.3 LCD aspect ratio

There are different LCD aspect ratios depending of the frontal panel sizes:

Table 3
LCD aspect ratio

Panel size	Aspect ratio
7.0" W	15 : 9
8.4"	4 : 3
10.1" W	16 : 10
10.4"	4 : 3
12.1"	4 : 3
12.1" W	16 : 10
15.0"	4 : 3
15.6" W	16 : 9

2.4 Rear view

Figure 9
C6 S14 rear view

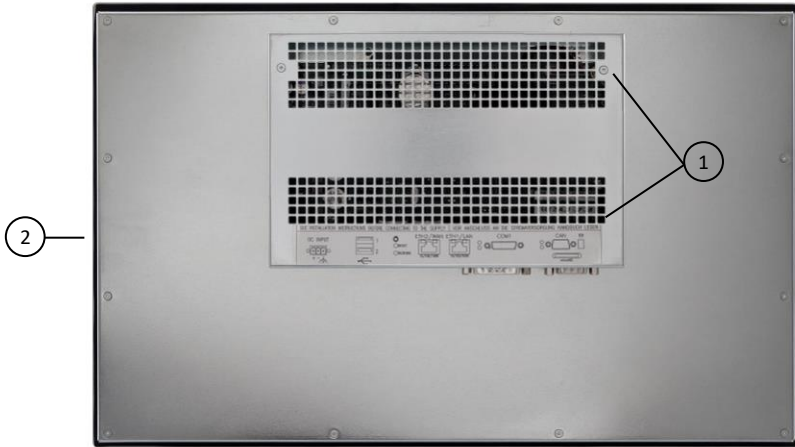

Note: Rear panels may be different depending on display size.

1	Aeration holes		
2	Mounting seal		

2.5 Side view

Figure 10
C6 S14 side view

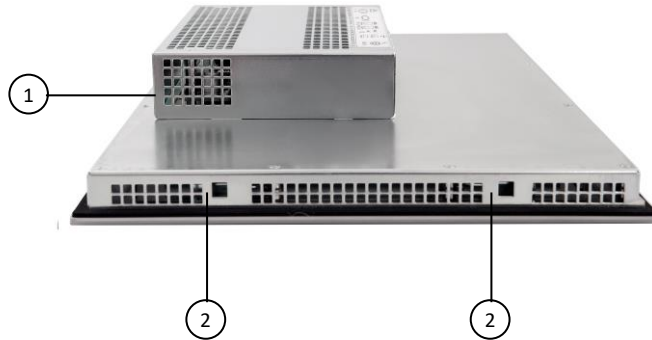
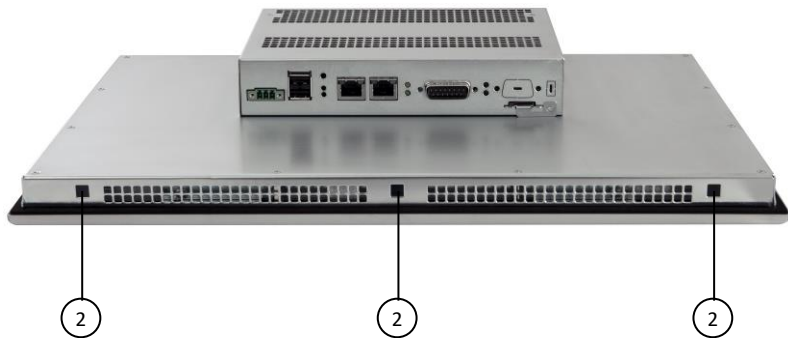

Figure 11
C6 S14 side view



1	Aeration holes		
2	Recess for fixing clamps		

2.6 Connector view

Figure 12
C6 S14 connectors

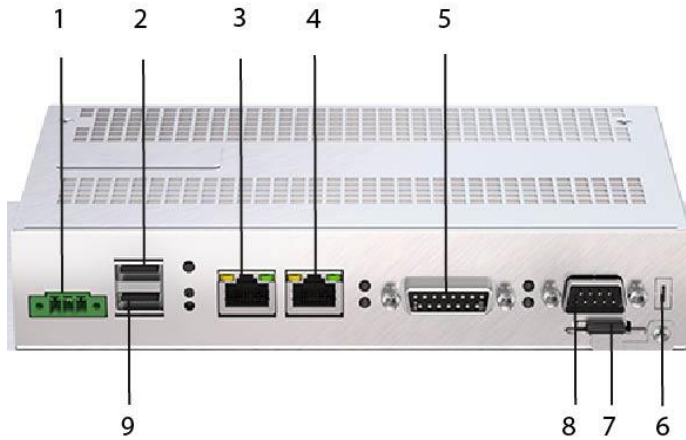

①	DC input
②	USB1 (2.0)
③	LAN1 (10/100/1000)
④	LAN2 (10/100/1000)
⑤	COM1 RS232/422/485 MPI
⑥	Termination
⑦	MicroSD slot
⑧	CAN/RS232/RS485 (optional)
⑨	USB2 (2.0)

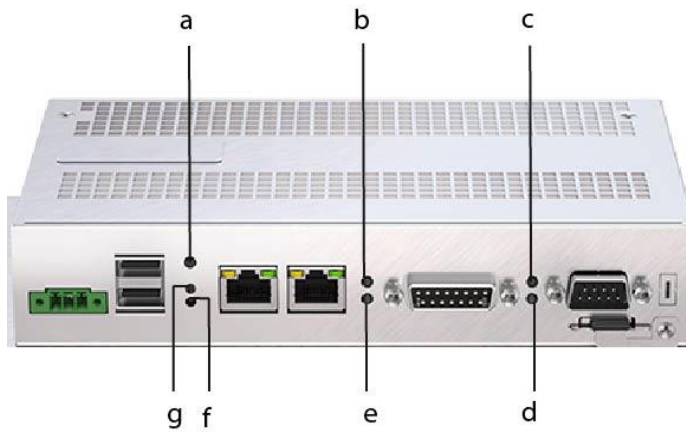

Ⓐ	Power On LED
Ⓑ	COM1 TX LED
Ⓒ	Error (CAN) / TX (RS485) LED
Ⓓ	RUN (CAN) / RX (RS485) LED
Ⓔ	COM1 RX LED
Ⓕ	Restore defaults
Ⓖ	Reset

2.6.1 Labels

The following labels are present on the rear panel:

- Connectors label
- CE label

Figure 13
System connectors label details

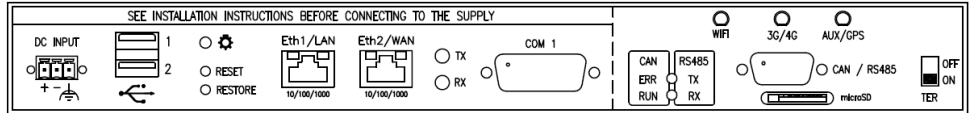
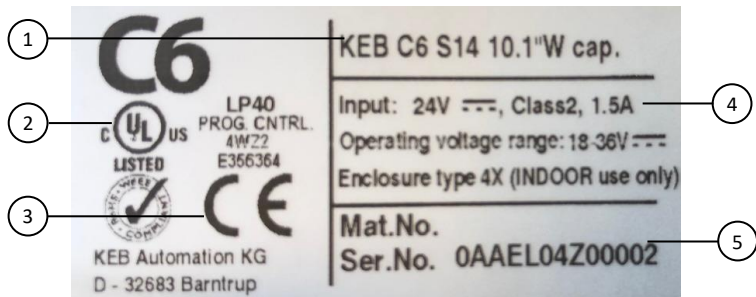

Figure 14
System label details



1	Model
2	UL marking
3	CE marking
4	Electrical information
5	Serial number

2.6.2 μUPS

UPS (uninterruptable Power Supply) devices are normally used to provide the continuity in the power supply circuitry to electronic devices where the electronics itself or the user's application hosted by the devices is critical from the possibility of a sudden loose of power. KEB μUPS is designed to be used in combination with CONTROL Runtime. The μUPS module is installed on the internal power supply unit.

Figure 15
μUPS details



① μUPS module

Notes about KEB μUPS

Energy storage	2 super-capacitors 28F 2.7V connected in series.
Charging time	30s
Typical operating time	Between 500ms and 1s
Maintenance	None
Installation	Built-in electronics and super-capacitors
Local memory directly managed by the power supply	Not volatile 256KB MRAM for Soft PLC retain feature; real available memory 128KB for RETAIN segment + 128KB for PERSISTENT segment
System's actions taken when in UNDER_VOLTAGE	LCD is switched OFF USB power supply is switched OFF
Handling of remanent data in KEB CONTROL runtime implementation	When receiving the UNDER_VOLTAGE signal the CPU starts a 20ms timer. When the timer is elapsed the system checks again the UNDER_VOLTAGE. If the signal is still active the system checks for the MICRO_UPS_VCAP_OK. If this signal is high the super-capacitors are ready and the peripherals are switched off (see previous point). The memory data block (128KB) is copied the MRAM memory. In case the super-capacitors are not ready, no data is saved to avoid possible data corruption. The data saving process can be estimated never exceeding 250ms at maximum. After the data copy has been completed if the UNDER_VOLTAGE signal is still active the system is turned off; if the UNDER_VOLTAGE signal is OFF the system is restarted automatically. In case of a shutdown command the data is saved and the system turned off. Note: Sleep mode is not supported.
User's application compatibility	YES, applications can subscribe μUPS "power-down event" form μUPS APIs. Note: The μUPS does not send any shutdown command to the OS, hence no files nor databases can be automatically closed without proper handling of the event. Note: If the CONTROL Runtime has to manage retain variables the user's "event-application" must work on a priority level greater than 10. Note: Please contact KEB support for further details about APIs availability and use.

2.7 Putting in operation

The followings two phases are required to put the system into operation:

- Configuration and project creation
- Process management

2.7.1 Configuration and project creation

During the configuration phase, you create the user interfaces for operation and monitoring of the technical process by using a PC on which is installed COMBIVIS studio HMI development environment. Configuration also includes:

- Creating the project
- Saving the project
- Testing the project
- Simulating the project

After compiling the configuration, you load the project into the C6 S14 device.

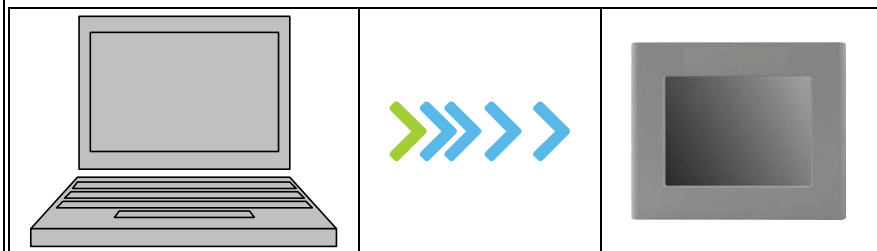

Figure 16
Configuration and project creation

2.7.2 Process management

Process management is a two-way communication between C6 S14 device and PLC.

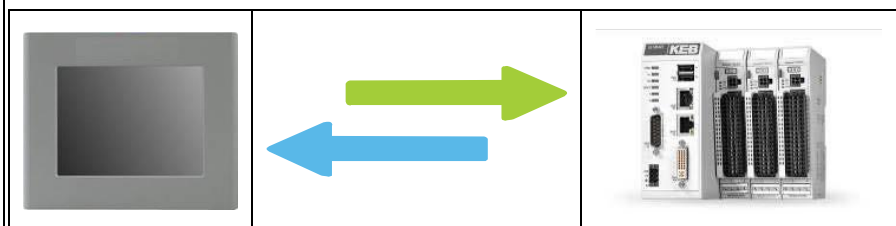

Figure 17
Process management

SECTION **3**

**Installation and
connection**

3.1 Preparation for installation

3.1.1 Select the mounting location

Points to observe when selecting the mounting location:

- a) Position the system to avoid exposure to direct sunlight.
- b) Position the system such that it is ergonomically accessible for the operator.
- c) Choose a suitable mounting height.
- d) Ensure that the Aeration holes are not covered.

3.1.2 Portrait Mounting

- The system can be mounted in portrait mode; the display can be rotate according to the mounting position using the dedicated utility from the panel control panel.
- From the Start menu, select "Settings" and then "Control Panel"; the display rotation utility is available from "Freescale Display Driver".
- Double click on the icon to get the window from where you can select the desired orientation.
- The selection is immediately applied and does not require to be saved in the registry.



Note:

See section 2.2 Package

3.2 Checking the package contents

- Check the package content for visible signs of transport damage and completeness.
- In the case of damaged parts, contact your KEB representative. Do not install parts damaged during shipment.

3.3 Checking the operating conditions

- Read carefully the standards, approvals, EMC parameters and technical specifications for operation of the C6 S14 device. This information is available in the following sections:
 - Certificates and approvals
 - Electromagnetic compatibility
- Check the mechanical and climatic ambient conditions for operation of the C6 S14 device: Ambient conditions.
- Follow the instructions for local use of the C6 S14 device.
- Adhere to the permissible rated voltage and the associated tolerance range:
 - 24V
 - Range: 18÷36 VDC

3.4 Mounting position

The C6 S14 device is suitable for installation in:

- Mounting cabinets
- Control cabinets
- Switchboards
- Consoles

3.4.1 Damage due to overheating

- The operative temperature must be between 0° and 50°C.
- All C6 S14 systems are designed for vertical mounting position.
- An inclined installation reduces the thermal convection by the C6 S14 device and the maximum permissible ambient temperature for operation. Please contact KEB for details.
- The C6 S14 device may otherwise be damaged and its certifications and warranty will be void.



Note:

For installation in control cabinets and, in particular, in closed containers, make sure the recommended ambient temperature is maintained.

*Figure 18
Mounting position*



3.5 Checking installation distances

To ensure adequate ventilation it is necessary to leave the following open spaces around the system:

- X direction: (min.) 15 mm for each side
- Y direction: (min.) 50 mm for each side
- Z direction: (min.) 100 mm

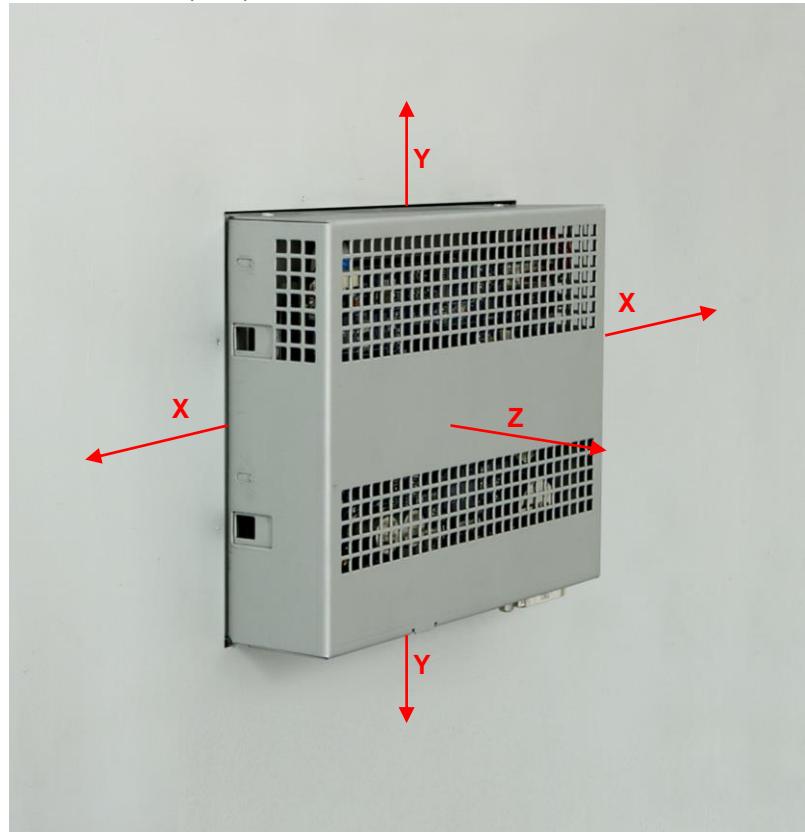

Figure 19
Installation distances

3.6 Preparing the mounting cut-out

In order to ensure a proper mounting of the system, the material of the mounting cut-out must be sufficiently stable.

To obtain the degree of protection described below, the material of the mounting panel must not deform due to the use of clamps on the operator panel.

3.6.1 Degrees of protection

The degrees of protection of the system are guaranteed only if the following conditions are satisfied:

- Material thickness at the mounting cut-out for IP66 protection: 2 mm to 6 mm.
- Deviations of the plane of the mounting cut-out limits: $\leq 0,5$ mm. This condition must be fulfilled even when the C6 S14 is installed.
- Allowed surface roughness in the area of the seal: ≤ 120 microns (Rz 120).



Note:

7"W front panel is available in two versions which are different for size and a cut-out measures.

3.6.2 Cut-out measures

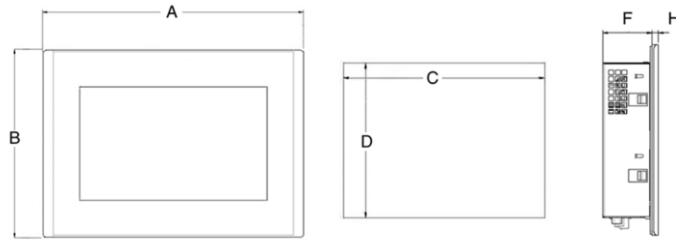

Figure 20
Cutout

C6 S14 resistive	Cutout "A"						
LCD TFT	A	B	C	D	H	F	Weight (Kg)
7"W	215	155	204	144	5	40 / 48*	1.2
8.4"	255	190	243	179	5	49 / 57*	1.4
10.1"W	293	201.5	285	193.5	5	49 / 57*	1.6
10.4"	295	230	283	219	5	49 / 57*	1.8
12.1"	325	260	313	249	5	49 / 57*	2.1
12.1"W	321	222.5	313	215	5	49 / 57*	2.0
15"	390	305	378	294	6	49 / 57*	3.3
15.6"W	420	265	410	255	6	49 / 57*	3.3

C6 S14 capacitive	Cutout "A"				Cutout "B"				H	F*	Weight (Kg)
LCD TFT	A	B	C	D	A	B	C	D	H	F*	Weight (Kg)
7"W	-	-	-	-	204	147.6	197	140.5	4	40 / 48*	1.2
10.1"W	293	201.5	285	193.5	-	-	-	-	5	48 / 56*	1.6
12.1"W	331	222.5	313	215	-	-	-	-	5	51 / 59*	2.0
15.6"W	433	267	410	255	-	-	-	-	6	49 / 57*	3.3

* with μUPS

**Note:**

For use on a flat surface of a Type 1 IN-DOOR Enclosure.

3.7 Mounting the device

3.7.1 Position of the mounting clamps

- To obtain the declared degree of frontal protection for the system, it is necessary to respect the positions of the clamps shown below.
- The table below shows the number and the position of the clamps for each C6 S14 size.





System LCD size	Clamp	Quantity	Clamp position
7.0"		7	
8.4"		8	
10.1" 10.4" 12.1" 15" 15.6"		10	

Table 4
Position of the mounting clamps

3.7.2 Tools to tighten the mounting clamps

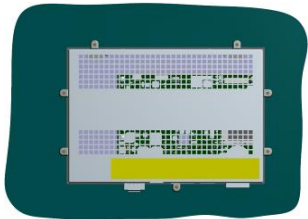
- 1.5 mm hexagonal key

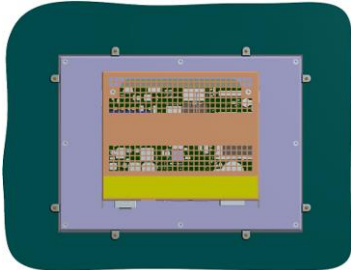
3.7.3 Procedure

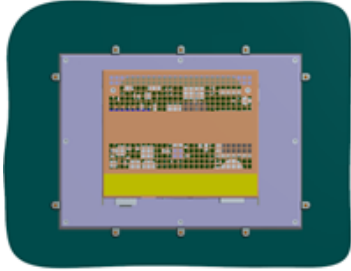
- Insert the system into the mounting cutout from the front.

Figure 21
Installation



Figure 22
Installation



Figure 23
Installation



- Insert the fixing clamps into the housings of the device.

Figure 24
Installation



Figure 25
Installation



**Note:**

Value of tightening torque: **0.2 Nm**.

Figure 26
Installation

- Tighten the fixing clamps with a 1.5 mm hex key.

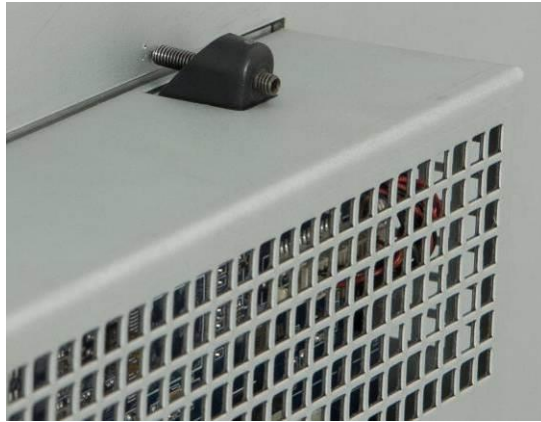

- Repeat steps 2 and 3 for all mounting clamps.
- Check the seal seat.

3.8 Connecting the device

3.8.1 Notes on connection

- The system must be installed in accordance with the indications contained in these operating instructions.
- These devices are intended to be connected to a “Secondary Circuit Over-voltage Category II”

3.8.2 Power supply connection

The device may only be connected to a 24V $\overline{\text{---}}$ (maximum permissible operating voltage range 18V to 36V) power supply which fulfills the requirements of safe extra low voltage (SELV) in accordance with IEC/EN/DIN EN/UL60950-1.

The power supply has to fulfil the requirements NEC Class2 or LPS in accordance with IEC/EN/DIN EN/UL60950-1.

Connect the device with a cable cross-section of 0.75 – 1.5 mm² (AWG18 to AWG16 suitable at least 75C°).

- Remove the three poles connector from the system
- Connect the positive wire to the positive terminal of the three pole connector
- Connect the negative wire to the negative terminal of the three pole connector
- Connect the earth ground wire to the ground terminal of the three pole connector

(also refer to the label on the back of the system)



Attention:
the system must be powered with a voltage of 24V (18V÷36V).

Figure 27
Power supply connection details

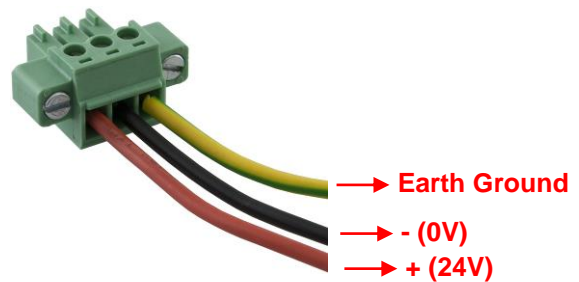

Figure 28
Power supply connection details



3.8.3 Switching on and testing the device

Connect the power supply cable to the system. Switch on the power supply. The green LED lights up.

Figure 29
Power supply connection details



The display will switch on accordingly, and after few seconds the Windows CE desktop will appear.

3.9 Connecting the configuration PC

You can connect the configuration PC to the system in several ways:

- 1) By using an Ethernet cross cable connected by one end to the configuration PC and on the other end to one of two Ethernet ports of the system.
- 2) By connecting the system to a Ethernet switch on which the configuration PC and the system are both connected

Please note that the system comes with the IP address 192.168.0.100.

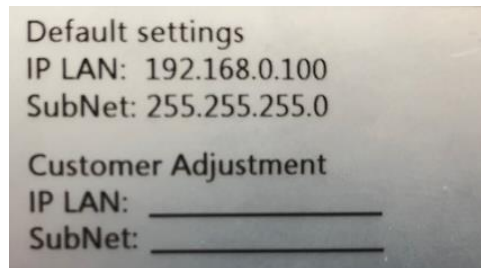

- Click on the start Button, select “Settings” -> “Network and Dial-up Connections”

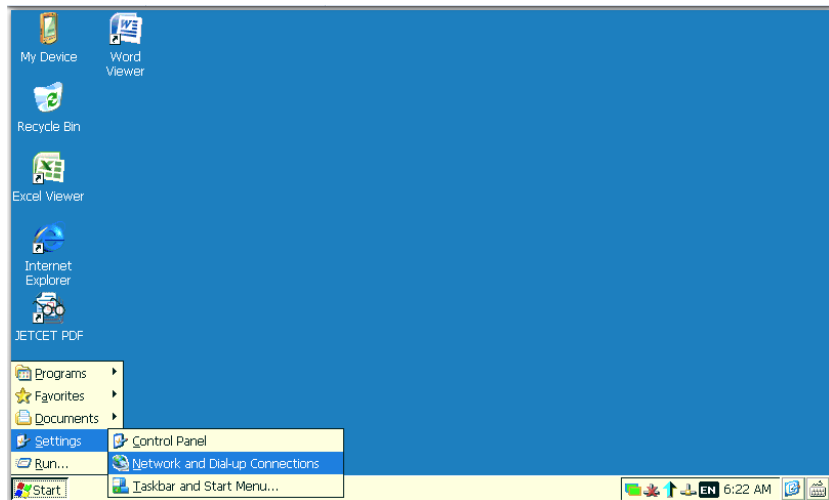

Figure 30
Connecting the configuration PC

- According to the Ethernet port you want to configure choose the port to configure according to the table:

LAN port on C6 S14	LAN Connection in control panel
LAN1	EtherCAT
LAN2	Ethernet

Table 5
Connecting the configuration PC

- For instance if you need to configure LAN2 double click on PCI LAN2, Click on “Specify an IP address” and write the IP address and default Gateway like in the figure below

Figure 31
Connecting the configuration PC

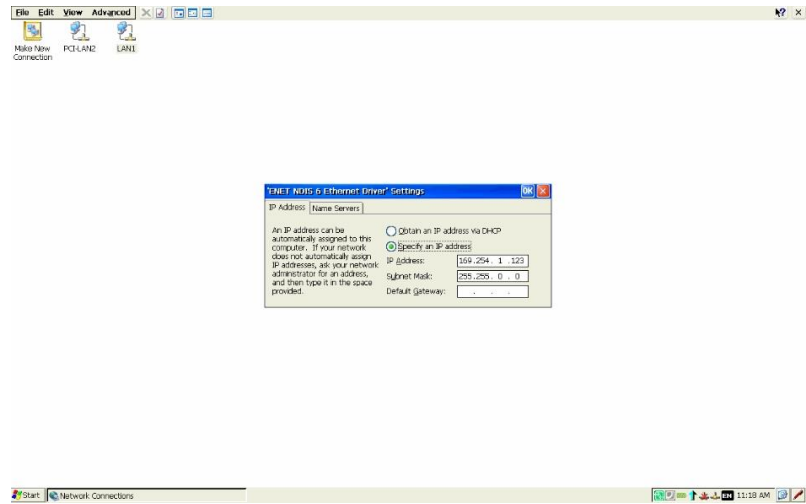

- Click on Ok to save the settings.
- Click on the “Start” button and select “Settings” -> “Control Panel”

Figure 32
Connecting the configuration PC

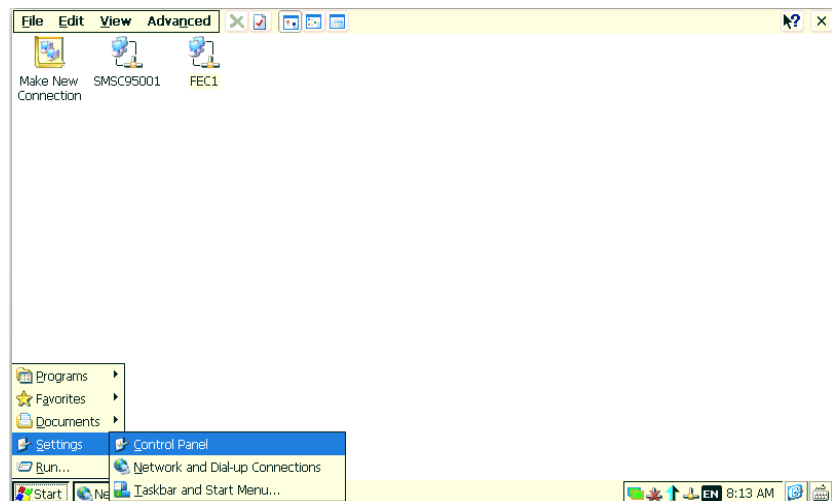

- Then double click on “Registry Saver”



Figure 33
Connecting the configuration PC

- Click on the “Save” button and confirm clicking on “Ok”. This operation will save your setting in a way.

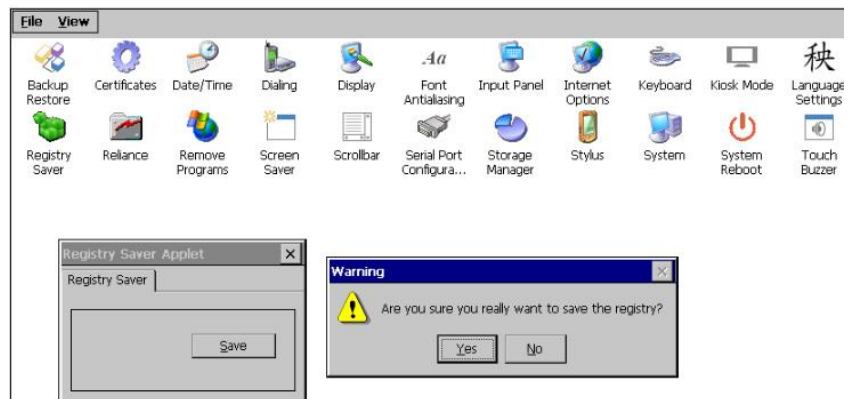

Figure 34
Connecting the configuration PC

SECTION **4**

**Commissioning the
device**

4.1 Storage

The system comes as standard with an eMMC memory. The eMMC memory can be used to store other data, like process data or other executable. It is not possible to disable writing into eMMC. You can always read and write the eMMC memory. The purpose of this memory is to store data produced during the running of the machine or plant supervised by the system.

The eMMC memory is formatted using the "Datalight Reliance Nitro" file system specifically designed to improve the mass memory management ensuring reliability and robustness under the most diverse use conditions including intrinsic security of the write operations even in case of a power failure.

The Windows CE Control Panel includes the utilities to manage the storage devices.

To manage the eMMC use the "Reliance Volume Manager" utility.

Figure 35 Commissioning the device

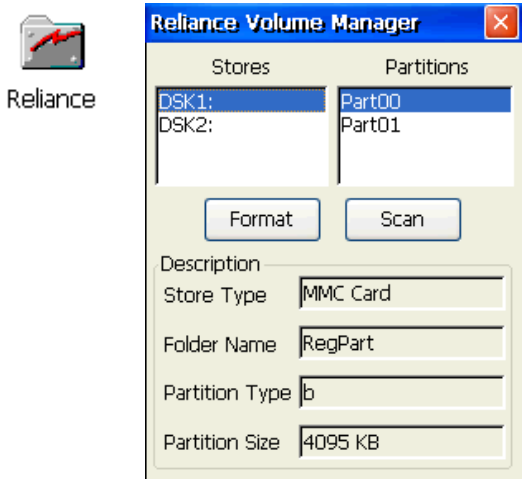

Note: If required, please contact the technical support for any assistance about the use of the volume manager utility.

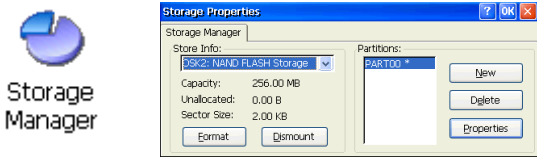

4.2 Slot for memory card

The system can optionally accommodate a microSD card slot V. 2.0 (push-push type).

Figure 36
Slot for memory card

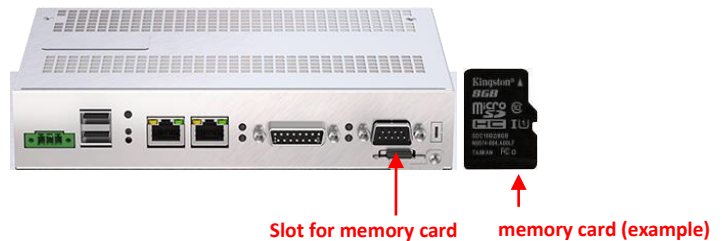

Attention:

potential data loss

Do not remove the memory card while data is being accessed.

Data on the memory card is lost if you try to remove it while the system is accessing the data.

4.3 Installation/removal of a memory card

- Insert the memory card into the slot as indicated in the figure. Pay attention to the beveled edge.

Figure 37
Slot for memory card

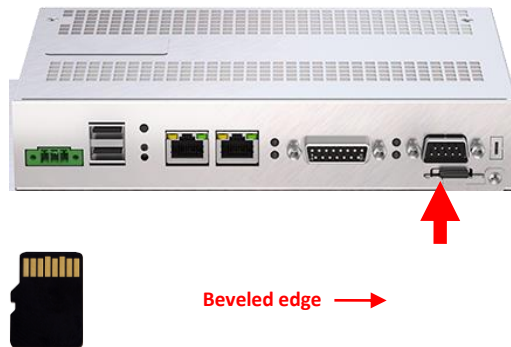

Attention:

removing the system memory card while the project is running. If you remove memory card while a project is running, the project may stop.

- Push the card all the way.

Figure 38
Slot for memory card



Figure 39
Slot for memory card



- Push the card previously inserted.

Figure 40
Slot for memory card



- Extract the memory card from the slot.

Figure 41
Slot for memory card



SECTION **5**
**Commissioning a
project**

5.1 COMBIVIS studio HMI project

5.1.1 Overview

Configuration phase

A project includes screen, alarms, variables used to represent the real plant of machine. The configuration phase is the creation of the project according to the user needs and interaction between the humans and the machine.

Transferring the project to C6 S14

You can transfer a project to C6 S14 as follows:

- Transfer from the configuring PC by using an Ethernet connection.
- Copy the project by using ab USB key.



Note:

If you need to communicate with a device connected to the serial port you must configure the serial port.

Process control phase

After the project is transferred, C6 SMART is ready to communicate to one or more PLCs and to visualize the screens according to the configured project.

Commissioning and re-commissioning

When you switch on the first time C6 S14, there is no project inside. At first you need to transfer a project into C6 S14.

After you have loaded a project, you can transfer back another project or another version of the same project (without setting to a special operating mode); this is also possible while the project is running on C6 S14.

5.1.2 Transfer

C6 S14 is always ready for accepting the download of a project; even when a project is running. In this way, if C6 S14 is connected by means of Ethernet to the configuration PC, you are able to download a new project or a new version of the same project even without stopping the project.

5.1.3 Configuration of the serial port

If your project need to communicate with a device connected to the serial port, you need to configure the serial port according to the type of serial connection you use for your communication. The following types of communications are supported by the serial port of C6 S14:

- RS 232
- RS 422
- RS 485

C6 S14 comes as default with the serial port set as RS 232. If you want to change the type of serial communication you must do the following:

- Go to "Control Panel"

Figure 42
Opening Control Panel

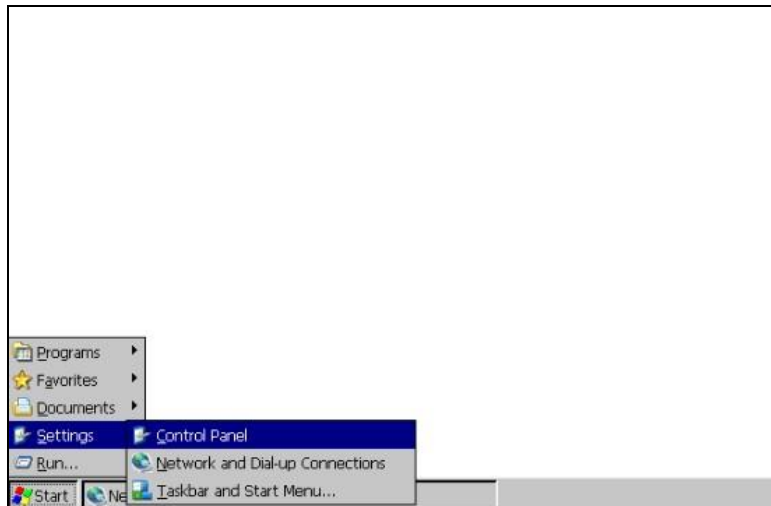

- Double click on "Serial Port Configuration"

Figure 43
Starting the configuration for the serial port

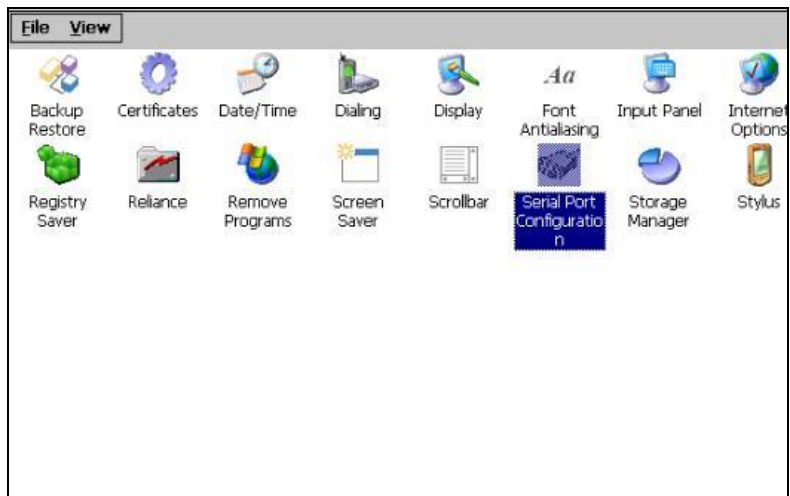

- Selection of the serial port

**Note:**

This applet can be used to check which serial communication mode is active. In this case it is sufficient to click on the red cross in the field on the top right.

Figure 44
Configuration for the serial port



And confirm by pressing the “Apply” button. A warning message will rise, advising to store that new configuration is active and saved a permanent way.

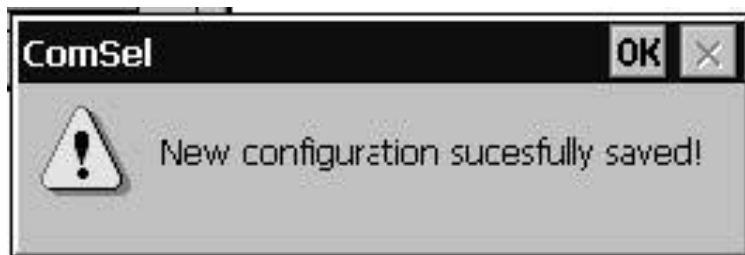

Figure 45
Serial Port configuration saved

Please note that the MPI mode cannot be selected, if this protocol is used by the HMI software, all necessary settings are applied automatically.

5.1.4 Connecting the serial port

A special DB15 connector supports all serial protocols. Therefore it is necessary to adapt the connections to the technical requirements; KEB can supply connector adapters as optional parts but user can adapt DB15 connector by himself.

5.1.5 Managing the project

C6 S14 has powerful tools to manage a running project. With the same mask used to transfer the project (see below) you can also:

- Stop the C6 S14 project from the configuration PC
- Start the C6 S14 project from the configuration PC
- Debug the project from the configuration PC
- Transfer the project from C6 S14 to the configuration PC

5.1.6 Stopping the running project

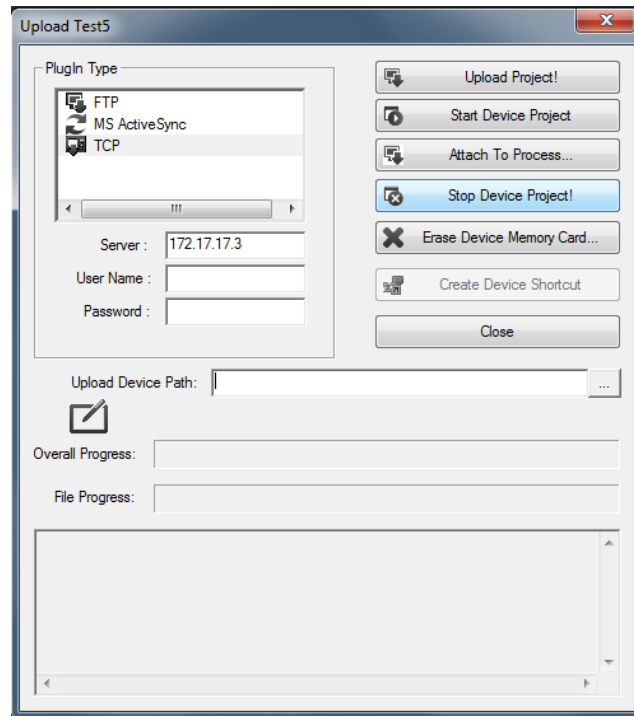

Figure 46
Stopping the running project

To stop a project running in C6 S14, you must:

- Select TCP in the upper left list
- Enter the IP address of C6 S14
- Click on the button “Stop Device Project!”

You will see the project in C6 S14 stops (see below)

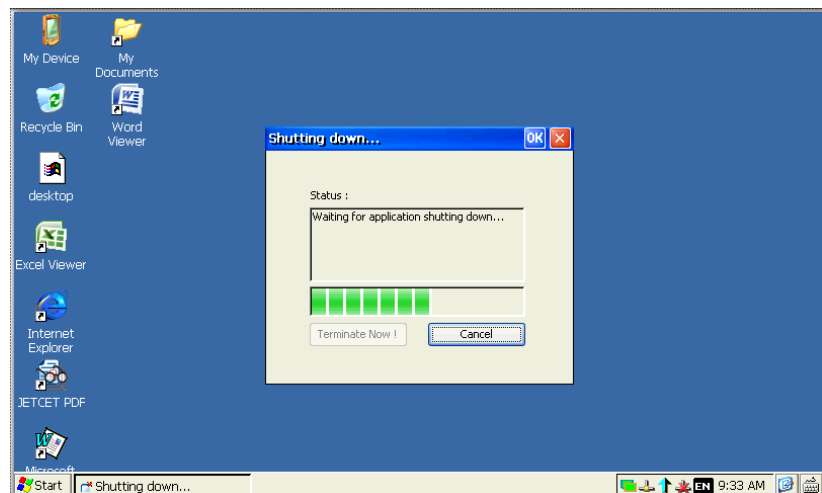
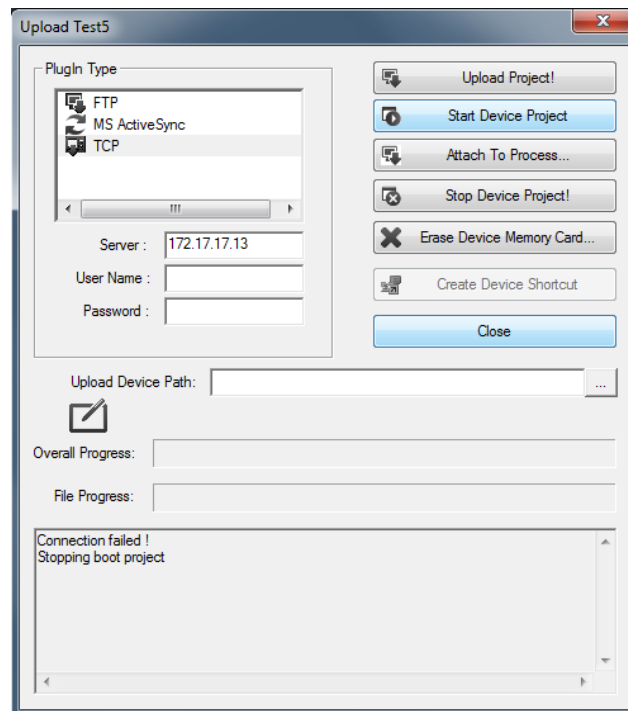

Figure 47
Stopping the running project

5.1.7 Starting the project

Figure 48
Starting the project



To start a project in C6 S14 by using the configuration PC you must:

- Select TCP in the upper left list
- Enter the IP address of C6 S14
- Click on the button “Start Device Project”

You will see the C6 S14 project starting (see below).

Figure 49
Starting the project

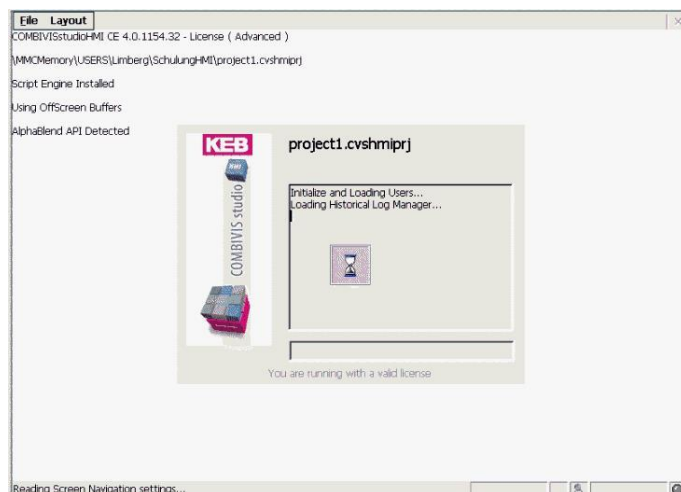

If there isn't a project in C6 S14 you will have an error.

5.1.8 Debugging the project

You can debug the project in C6 S14 by connecting with the configuration PC. In order to be able to use the debugging functionality you must prepare your project as follows:

1. Select “Networking” in the project explorer window of COMBIVIS studio HMI
2. Enable the property “Debugger” in the Properties window of COMBIVIS studio HMI

Figure 50
Debug the project

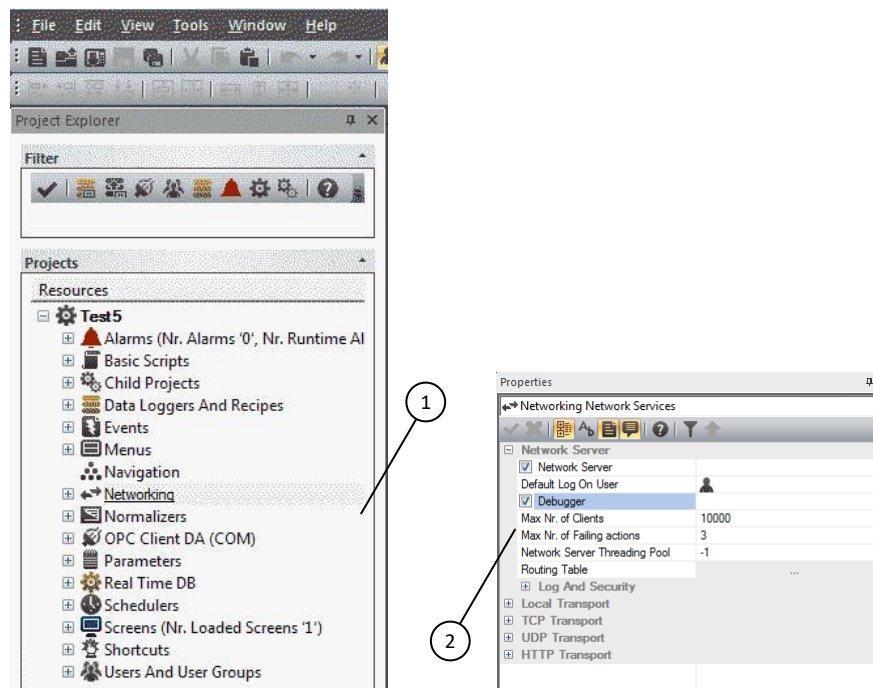

Transfer the project to C6 S14 and start it.

NOTE: Be sure that the project is running; otherwise you cannot debug the project.

To debug the project running in C6 S14 from the configuration PC, follow these steps:

1. Select TCP in the upper left list
2. Enter the IP address of C6 S14

Click on the button “Attach to process...”

Figure 51
Debug the project

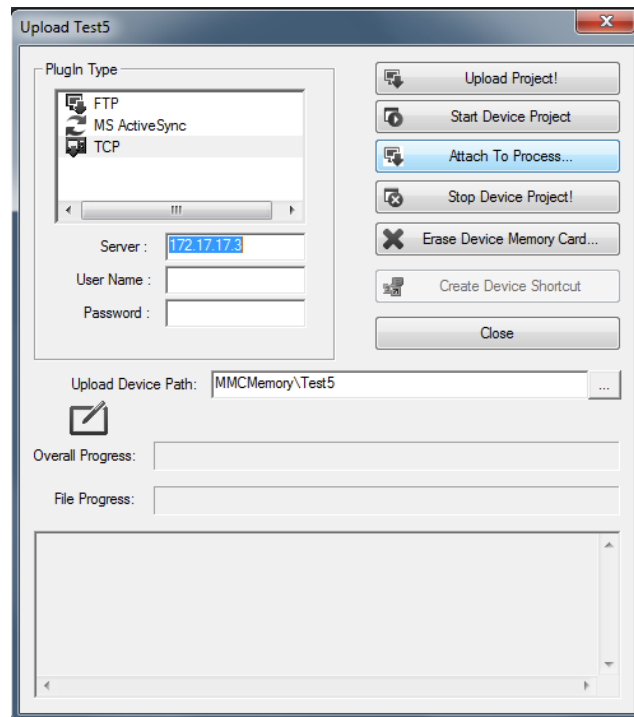

The following window will appear

Figure 52
Debug the project

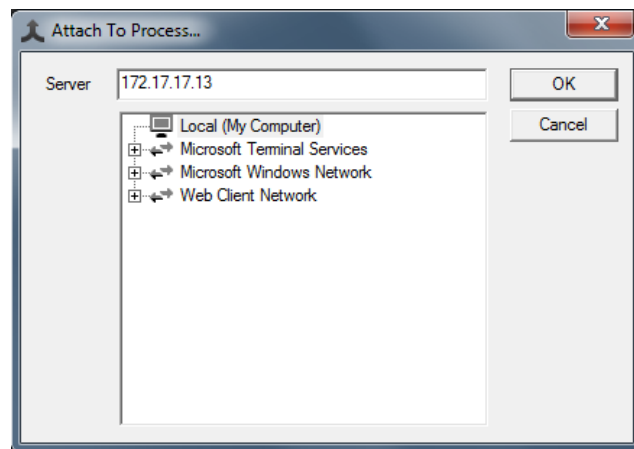

Write the IP address of C6 S14 and click on the "OK" button. A new windows asking for user and password will appear

Figure 53
Debug the project

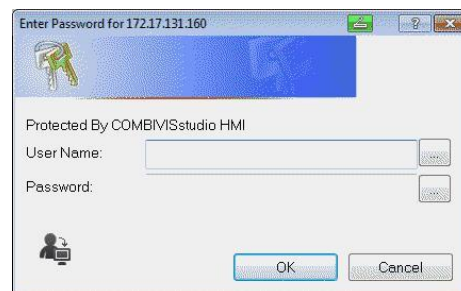

In case the project is not protected, just click “OK”, otherwise insert the name and password of a project user that has the rights to change the project.

You will see that a debug session will start in COMBIVIS studio HMI on the configuration PC. Now you are able to:

- See the project screens and navigate between them. Please note that you can see different screen from those seen on C6 S14 and that your debugging is not affecting the normal running of C6 S14 project
- See and change the value of the variables
- Put breakpoint and debug Visual Basic scripts running in the project

5.1.9 Transfer the project from C6 S14 to the configuration PC

With this option you can transfer the project from C6 S14 to the configuration PC to check or change it and then transfer it again to C6 S14.

Note: It is always suggested to protect the project with a password in order to don't allow changes to the project.

Be sure that the project is not running on C6 S14. When COMBIVIS studio HMI runs on the configuration PC, click on the “File” menu and select “Open Device Project...”.

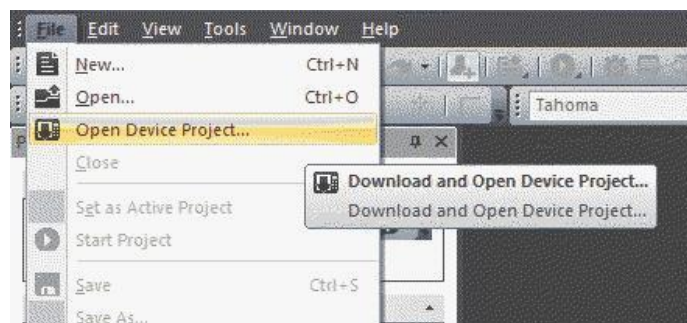
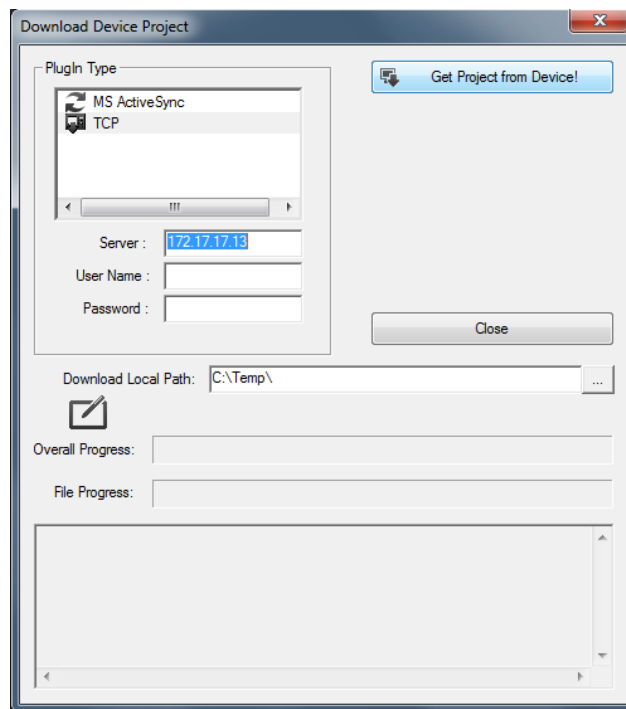

Figure 54
Debug the project

1. Select TCP in the upper left list
2. Enter the IP address of C6 S14
3. Write the path on which you want to store the project on your configuration PC
4. Click on the button “Get Project from Device!”

Figure 55
Debug the project



After the transfer of the project you will see the project explorer containing the project resources in COMBIVIS studio HMI and you will be able to check, test and change the resources of the project.

5.1.10 Backup and restore

C6 S14 provides tools to backup and restore the contents of its internal memory in order to manage the project and the operating system of C6 S14. For more information please contact the support center of KEB.

5.1.11 Updating the operating system

Please contact the support center of KEB.

5.2 COMBIVIS studio 6 BASIC/PRO/ADVANCED

This chapter is valid only for C6 S14 systems which are delivered with CONTROL Runtime pre-installed directly from production.

5.2.1 Project Implementation

The CONTROL Runtime runs as a thread with "real time" priority.

The execution model is based on the "task" concept; the program execution requires the definition of tasks and the assignment of priority and execution cycle according to the following figure (see below in this manual about how to configure COMBIVIS studio 6).

Figure 56
Task configuration

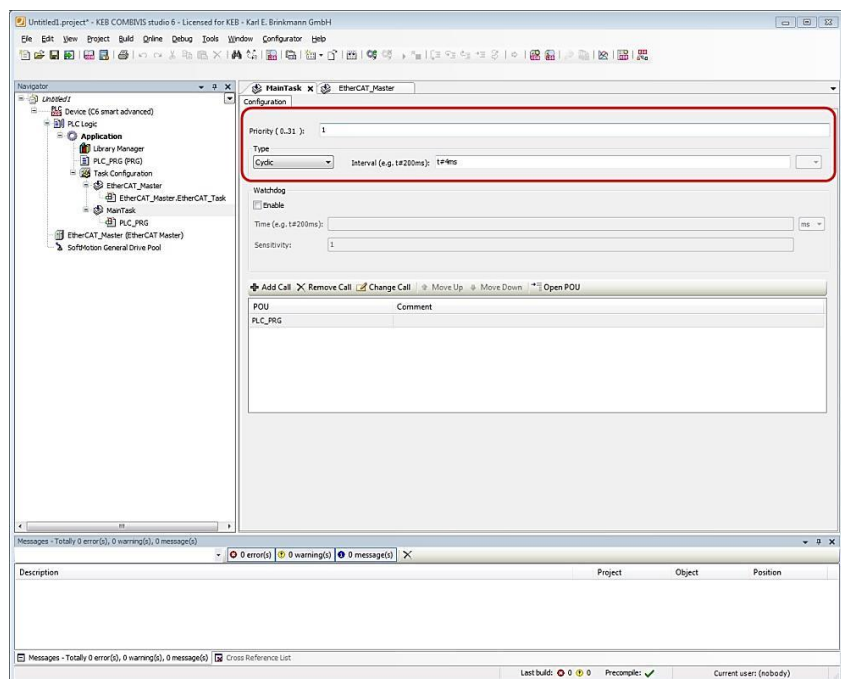

Each task is executed at the specified time interval and according to the assigned priority. Only when all the CONTROL Runtime activities are over, the CPU time goes to the other processes, as they are assigned to an inferior priority.

Note: Each task cycle time must be properly assigned according to the general performances required by the Soft PLC itself, by the COMBIVIS HMI Runtime, by the COMBIVIS connect Runtime and by any other application or process running in the system. A too short task cycle time may introduce an undesired slowdown in the general reaction of the system. If this is the case, the task cycle time should be properly increased until you reach the proper balancing between performances and reactivity of the whole system.

5.2.2 Transferring the COMBIVIS studio 6 application to the target system

To transfer a valid "COMBIVIS studio 6" application of the target system, follow these steps:

- Ensure the C6 S14 device is connected to the same sub network of the PC where you have running the COMBIVIS studio 6 programming tool (same network mask, e.g. "192.168.1.xx").
- Double click on the device icon from the COMBIVIS studio 6 project tree; the right part of the workspace will show the "Communication settings" tab contents
- Select the Gateway and click on the button "Scan network" button
- The box will be populated with the list of available CONTROL Runtime
- Click on the one you want to connect to and click on the "Set active path" button
- Click On-line\Login to start the communication

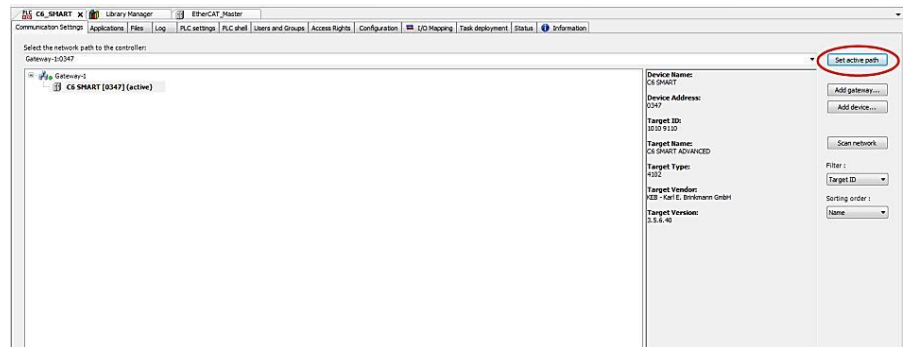

Figure 57
Setting the active path

5.2.3 I/O Fieldbus

The COMBIVIS studio 6 implementation for C6 S14 systems supports the following I/O fieldbuses:

- EtherCAT with DC support (distributed clock) on LAN1
- Modbus TCP on LAN2
- Modbus RTU

To insert the I/O master right click on the C6 S14 device icon on the project tree, select “Add Device” and select from the “Vendor” list box “KEB Automation KG”.

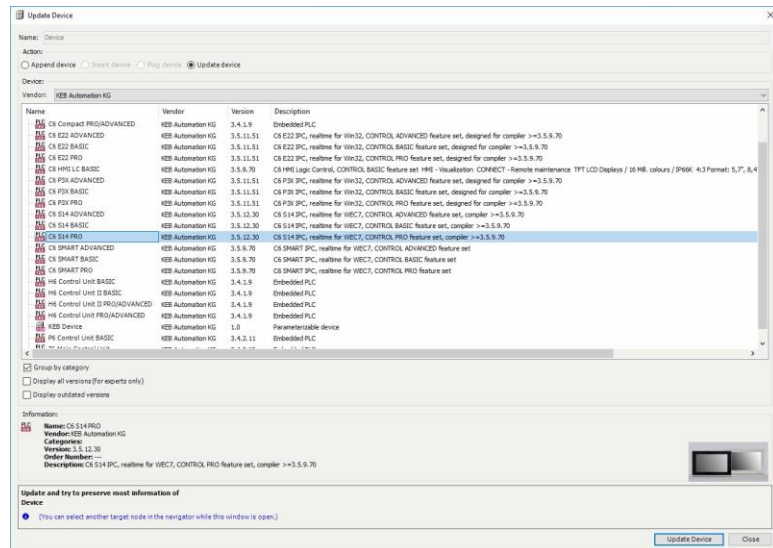

The list will be populated with the available master devices. Select the one required by your application in between:

- EtherCAT Master
- Modbus COM (for Modbus based I/O both serial and TCP)
- CANbus

C6 S14 systems are featuring two Ethernet interfaces.

The interface that must be used for I/O fieldbus is the one denominated “LAN1”.

5.2.4 Support for retentive data

C6 S14 systems are equipped with a Micro UPS specifically designed to support the data memory retention.

In COMBIVIS studio 6 the remanent variables can retain their value throughout the usual program run period. They are declared as “Retain Variables” or even more stringent as “Persistent Variables”. For each case a separate memory area is used.

Please check the COMBIVIS studio 6 manual for any additional detail about remanent data.

The use of the remanent areas does not require any specific configuration except for declaring the variable in the proper area according to the COMBIVIS studio 6 programming manual.

Note: To start the backup procedure the super capacitors must be fully charged.

At the moment of a power failure (when the voltage is below the threshold for more than 20ms) the UPS triggers an event and the system will switch off the display and the USB device connected in order to save energy, and will follow a four step sequence to save data:

1. The panel display and the USB ports are turned off
2. All running IEC tasks are terminated. Thus, the remanent areas are consistent.
3. The system starts flushing the remanent memory areas to a file which is saved on disk
4. The CONTROL Runtime is terminated

The charging status of the UPS can be checked with the object UpsInterface (IoDrvUPS), which is coupled to the target device C6 S14.

Figure 58
Start CDlauch-Mgr.exe

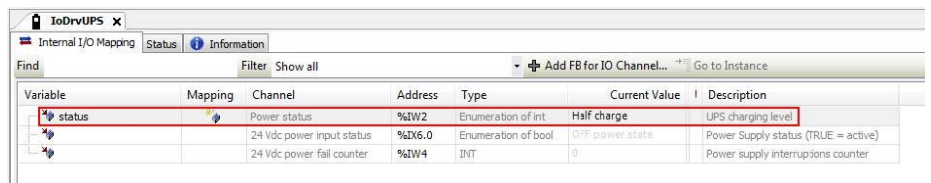

Variable	Mapping	Channel	Address	Type	Current Value	Description
status		Power status	%IW2	Enumeration of int	Half charge	UPS charging level
		24 Vdc power input status	%IW6.0	Enumeration of bool	OFF power state	Power Supply status (TRUE = active)
		24 Vdc power fail counter	%IW4	INT	0	Power supply interruptions counter

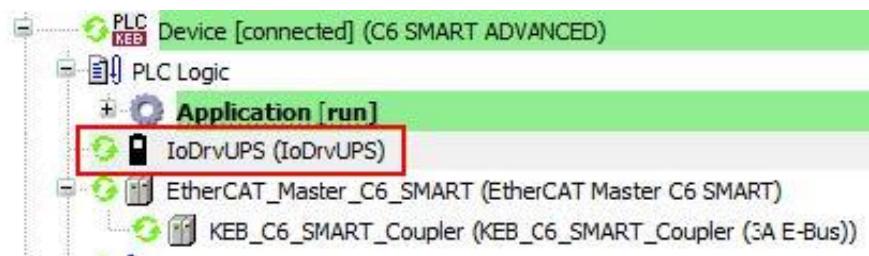

Note: To start the backup operation, the capacitors must be fully charged (after the charging process, the power LED must be switched from yellow to green).

Note: The available remanent memory size is 64kB for the RETAIN memory type and 64kB for the PERSISTENT memory type.

Note: If the power supply returns before the energy inside the Micro UPS is finished, and actually C6 S14 has not been switched off, the following operations are carried on:

- The display is switched on
- The USB ports are powered
- CONTROL Runtime behavior can be selected in between 3 possible models:
 - 1) CONTROL Runtime does not start and no message is returned.
 - 2) CONTROL Runtime does not start and returns a warning message.
 - 3) CONTROL Runtime restarts normally (default option).

The COMBIVIS studio 6 restart behavior can be configured directly by the user by means of the COMBIVIS studio 6 launcher manager program.

The launcher manager of the CONTROL Runtime is an application stored in the "\\MMCMemory\CoDeSys3" folder as shown in the following figure.

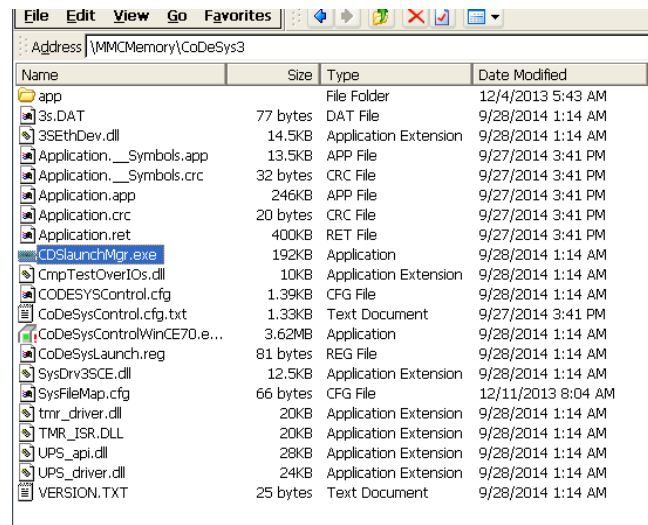

To start it, double click on the file name.

The launcher manager interface is shown in the following figure.

Figure 59
CDS Launch Manager

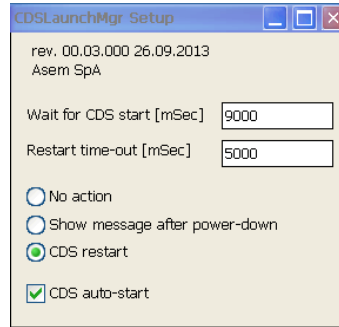

The parameter "Wait for CDS start" is the time the launcher waits before starting the CONTROL Runtime.
 "Restart timeout" is the time the launcher waits before restarting CONTROL Runtime.

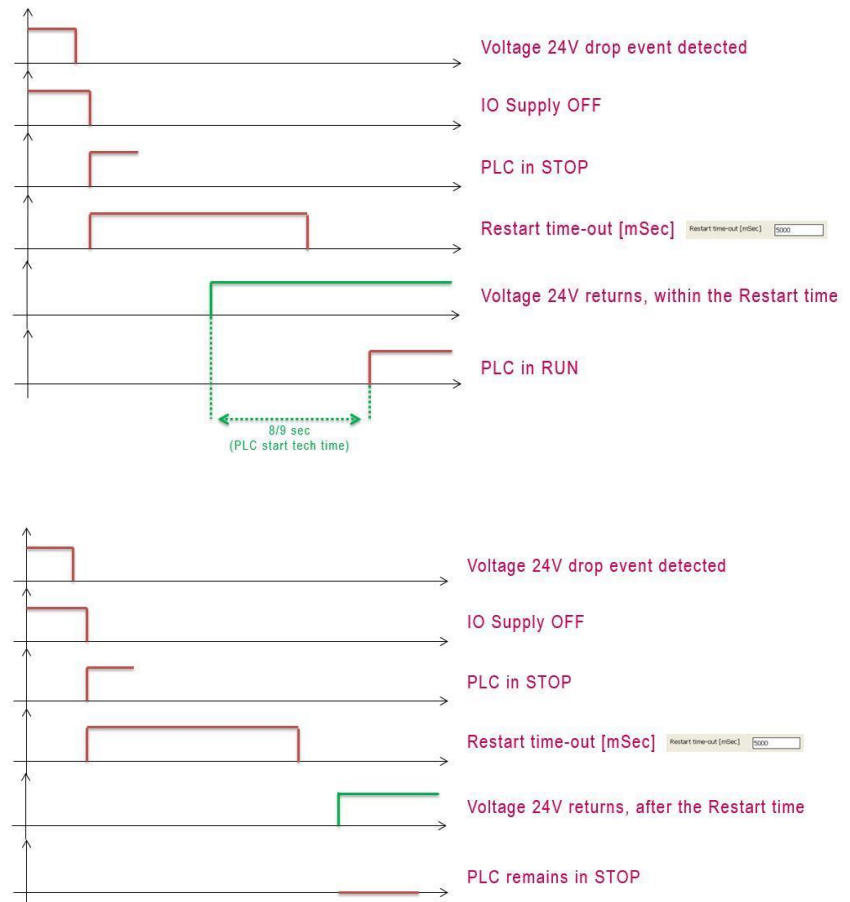

5.2.5 Use in combination with COMBIVIS HMI Runtime

COMBIVIS HMI Runtime can be configured to communicate with the CONTROL Runtime. The C6 S14 CONTROL Runtime implementation includes the CODESYS Gateway which is then used as communication interface. The COMBIVIS studio HMI project must be configured to communicate with a generic CODESYS controller inserting in the “Real Time DB” resource. The driver called “CODESYS” as shown in the following figure:



Figure 60
Configuring COMBIVIS studio 6 project

The protocol uses a socket to communicate with the CONTROL Runtime through the Gateway component.

The Station must be configured to connect to “localhost”. The Device name is the one shown by the COMBIVIS studio 6 programming system when connected on-line with the C6 S14 device from the “Communication settings” window as shown in the following figure.

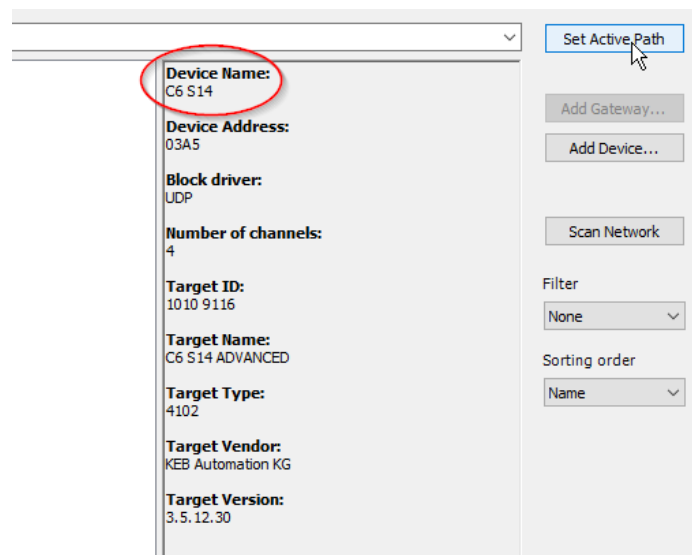
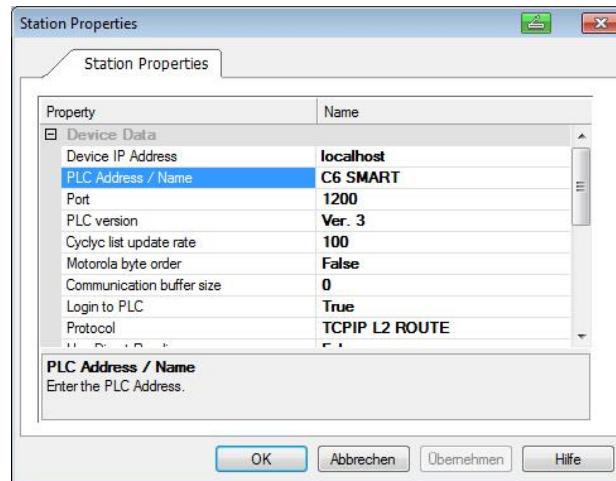

Figure 61
Device name in COMBIVIS studio 6

The HMI Station Properties will result as following.

Figure 62
CONTROL implementation



The CONTROL Runtime running on a C6 S14 device can be reached also from a panel which has been configured to belong to the same sub network. When having on the same sub network more than one C6 S14 system, you need to assign to them different name.

Note: The COMBIVIS studio HMI project can be configured to communicate with more than one controller in these cases the system can act as a gateway and transfer data through the different channels. For further information about this feature consult the COMBIVIS studio HMI online manual searching for “Variable Commands” and then “Move Value”.

5.2.6 Use in combination with COMBIVIS connect

The C6 S14 systems are featuring COMBIVIS connect Runtime preloaded and preconfigured.

It is possible to connect the system from remote using the COMBIVIS connect Control Center tool. The LAN2 (Eth2/WAN) network interface must be used for the Internet connectivity.

Figure 63
COMBIVIS connect implementation

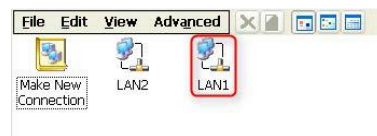
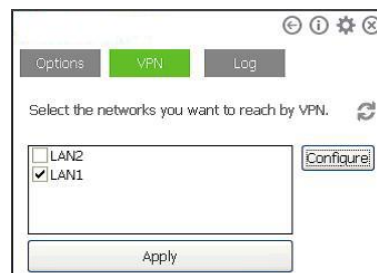

Figure 64
COMBIVIS connect implementation



The LAN1 (Eth1/LAN) interface must be used for the connection to the automation network or fieldbus. The two interfaces cannot be swapped.

The COMBIVIS connect setup for C6 S14 devices provides that the VPN is configured by default with LAN1.

Figure 65
COMBIVIS connect implementation

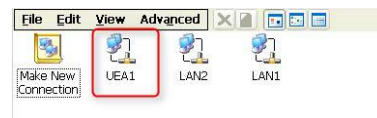
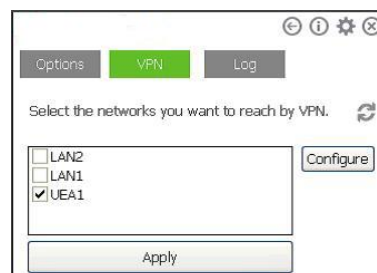

Figure 66
COMBIVIS connect implementation



The COMBIVIS connect setup for C6 S14 devices provides the installation by default of the COMBIVIS connect VPN virtual network adapter. The VPN is by default configured to be done with this adapter without any interference with the physical interface LAN1 which is normally used by CONTROL Runtime for the automation network or the fieldbus.

5.2.7 Limitations and Recommendations

In order to get the best balancing between functionalities and performances we strongly suggest to follow some guidelines when designing the applications for COMBIVIS studio 6 and COMBIVIS studio HMI.

- The PLC cycle time must be greater or equal than 1ms
- In general the CPU time reserved to CONTROL shall not be greater than 25%; this is calculated using the real time required by the PLC Runtime to complete the cycle and the time left free for all the other processes

Note: The maximum CPU time usable for the COMBIVIS studio 6 application is defined by a system parameter; in case the PLC program gets more than 25% of the CPU time, the CONTROL Runtime will be stopped. The user shall then properly change the PLC task timing in order to respect the limitation.

- The COMBIVIS studio 6 application shall use only one at a time of the 3 I/O fieldbus available
- The maximum number of bytes exchanged between COMBIVIS HMI Runtime and CONTROL Runtime shall not be greater than 1024
- The sampling time specified for data acquisition shall not be less than 15sec
- The scripting shall be carefully used in order to leave enough time to the other tasks to run without impacting too much with the general reaction of the overall system
- If the project has been configured to use the Web Client, you should consider that when an external client is connect you may experience a slowdown of the page change performance of the COMBIVIS HMI Runtime
- The "S7-MPI COMx" communication protocol from COMBIVIS studio HMI is not supported.

SECTION **6**
System Manager

6.1 System Manager

The System manager is a utility which is available for all ARM and x86 based KEB systems with WinCE operating system. It is available as integrated component of the operating system.

The System Manager aims to provide a comprehensive support to manage system specific features, such as clone, selective system components backup and related restore operations, system font quality settings and screen saver options.

It is available as a set of Control Panel applications:









Backup Re-store	 Backup Restore
Font Antialiasing	 Font Antialiasing
Screen Saver	 Screen Saver
Touch Buzzer	 Touch Buzzer
EMMC Usage	 EMMC Usage
Kiosk Mode	 Kiosk Mode
Language Settings	 Language Settings
Scrollbar	 Scrollbar
System Reboot	 System Reboot

Figure 67
System Manager Control Panel Applets



Note: Before starting Backup Restore operations the CONTROL runtime should be stopped. Otherwise Backup Restore operation can take very long time!

6.1.1 Backup Restore

The “Backup Restore” utility interface is shown in the following figure.

The utility provides two functionalities:

- System clone and restore
- Selective feature backup and selective restore

6.1.2 System clone and restore

To store Clone snapshots and selective feature backup, the System manager utility uses a single file container with extension “.ASR” which includes all the information and data required later for the restore operation.

Figure 68
Backup Restore

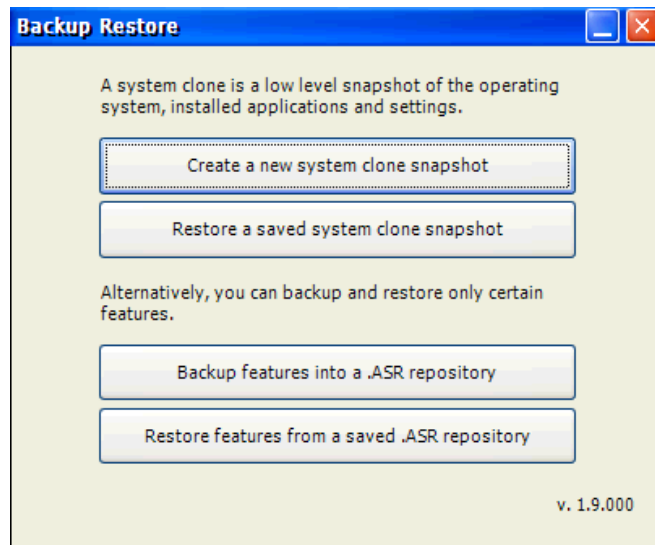

Note: The settings saved by the clone process are those related to the system (IP address, network configuration, system time, etc.) and those related to the application installed (Control project, HMI, Connect). Any specific user setting, except for the autorun keys) are not saved

The system clone creates a low level snapshot of:

- All the files on disk
- The operating system configuration from the registry
- The applications configurations from the registry

To process with the clone process, click on the “Create a new system clone snapshot” button.

The clone operation has two optional settings:

- 1) Operating system image: allows to create a clone of the operating system ROM image.
- 2) Custom registry keys: allow to specify custom keys to be saved in the backup.



Note: Destination path for the clone file can be only an external storage disk such a USB pen drive.



Note: The restore of a clone snapshot cannot be selective.



Attention:

When restoring a clone snapshot of a system associated to a COMBIVIS connect Domain, please consider that the COMBIVIS connect Identity is also restored.

This means that if the target device was already associated to a COMBIVIS connect Domain, it will lose its original identity. In case you need to keep it, it is suggested to save the "auth.bin" file from the COMBIVIS connect runtime installation folder before restoring the clone snapshot. When restoring a feature backup, the COMBIVIS connect identity of the target device is instead maintained.



Note: If the System manager is not able to determine the compatibility condition, it will display a warning message and final decision is left to the user.

Click "Run" to start the process.

You will be asked to provide a path where to store the clone snapshot.

Once the process is started the status bar at the bottom of the system manager application informs on the operation in progress.

To restore a clone snapshot you can simply click on the "Restore a saved system clone snapshot" button and locate the ".ASR" repository file.

The status bar at the bottom of the system manager application informs on the operation in progress.

The restore process provides the automatic shutdown of the running processes (Control project, HMI, connect). The file replacement from the archive and the processes restart at the end.

Compatibility check

A clone snapshot can be restored to the same system from where it comes as well to another device.

When doing the restore operation, the System manager utility will verify if the snapshot provided is compatible with the actual hardware.

Selective backup and restore

The selective backup provides support to backup only specific and selected features, files and application settings.

**Attention:**

The backup of the studio HMI application provides the backup of all the user's applications present on the "MMCMemory" flash disk. In case the Data folder has been moved out of the default path, it will NOT be saved in the backup.



Note: Destination path for the selective backup file can be internal or external storage disk.



Note: If the System manager is not able to determine the compatibility condition, it will display a warning message and final decision will be left to the user.

Once the process is started the status bar at the bottom of the system manager application informs on the operation in progress.

To start the selective backup, click on the button "Backup features into a .ASR repository".

The utility will display a list of available features and settings to be saved.

The window is self-explain, follow the instructions on the screen and mark the check box of the desired features you need to backup.

Once the selection is completed, press Run to select the target path and to start the process.

To restore a selective backup click on the button "Restore features from a saved .ASR repository" and locate the archive.

Once the archive has been loaded, you can press the "Details" button to check the archive contents. A complete list of all the features available in the .ASR archive, including application version, will be displayed.

The restore process provides the automatic shutdown of the running processes (Control project, HMI, connect), the file replacement from the archive and the new processes restart at the end.

The restore process may require several system reboots to complete; the process is fully automated.

Compatibility check

A selective backup can be restored to the same system as before or to another device.

When doing the restore operation of the operating system component the System manager utility verifies if the archive content is compatible or not with the actual hardware.

**Note:**

Font Antialiasing is *ONLY* supported by ARM based devices (C6 HMI, C6 HMI LC, C6 SMART).

6.1.3 Font Antialiasing

The utility allows the setting of the font quality rendering options.

Double click on the Control Panel icon and just select the desired rendering option.

Click OK to confirm.

The settings are automatically saved to the registry and no manual saving is required.

Figure 69
Font Antialiasing

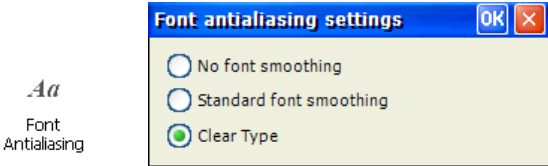

6.1.4 EMMC Usage

The utility provides useful information on the usage of the eMMC memory together with an indication of its health status.

Figure 70
EMMC Usage

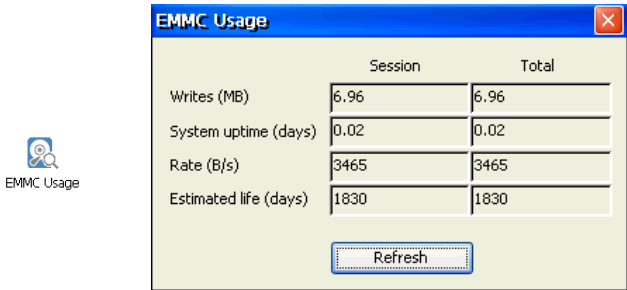

The information provided are divided per current session (since last power cycle) and in total since the installation of the System Manager utilities.

The utility provides the following information.

- Writes (MB)** Written data to the eMMC memory in MB
- System uptime (days)** Days since last power cycle
- Rate (B/s)** Average writing speed in B/s calculated considering the amount of data written and the uptime
- Estimated life (days)** Estimation of the memory life time calculated considering the maximum number of writes supported by the physical device (information from the memory manufacturer) and the rate of writes generated.

6.1.5 Kiosk Mode

The utility allows enabling of the kiosk mode.

When enabled, the panel will start directly the HMI Runtime with related project without showing the Windows CE Explorer.

Figure 71
Kiosk Mode

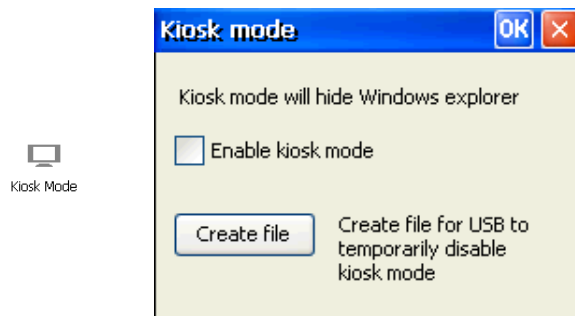

To enable kiosk mode, just open the utility and mark the “Enable kiosk mode” check box

At the moment you enable the kiosk mode, you can also create a file which allows temporarily kiosk mode deactivation. The file is created using the “Create file” button. Plug a USB pen drive into an USB port and store the file directly on the root of the USB disk.

If the USB pen drive is plugged in, the file is automatically recognized and kiosk mode will be disabled immediately until the next power cycle.

If you had forgotten to create the file at the moment the kiosk mode was enabled, you can simply make it manually by yourself.



Note:

If kiosk mode is enabled and the HMI Runtime is terminated, or simply closed with the proper command, Explorer will not be started automatically and you will apparently end up in a situation where the screen is frozen and not reacting. To avoid this annoying condition it is enough to include the launch Explorer command before the Runtime shutdown as shown in the figure below.

Create a text file named “SystemManager.xml”. Open it with any text editor and copy in, the following text.

```
<?xml version="1.0" encoding="utf-8"?>
<SystemManager>
  <Commands>
    <Command Type="RunProcess" FilePath="explorer.exe" Arguments="" WaitCompletion="0"/>
  </Commands>
</SystemManager>
```

Save the file and use it as explained before.

Figure 72
Launch Explorer from COMBIVIS studio HMI

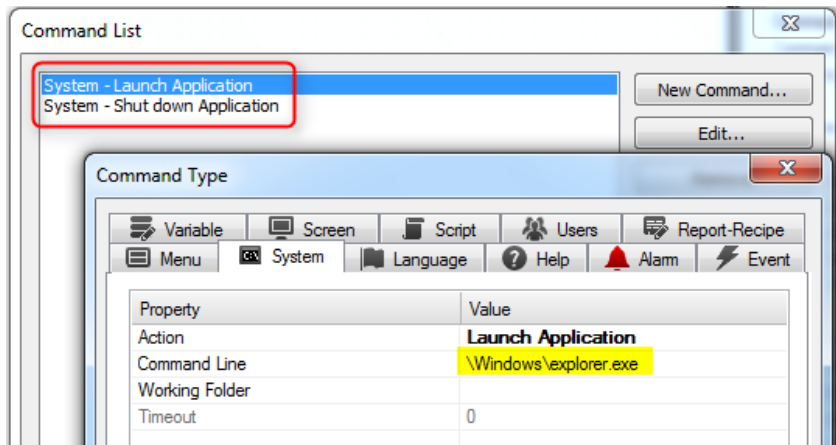

6.1.6 Language Settings

The utility provides fonts installation for the Chinese, Japanese and Korean languages

Figure 73
Language Settings

秧
Language Settings

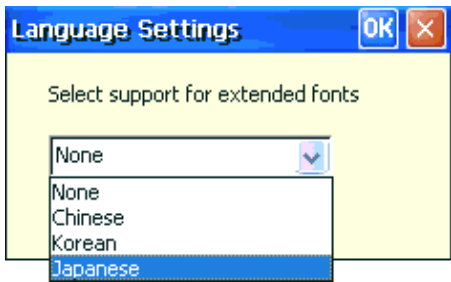

6.1.7 Scrollbar

The utility allows changing the size of the windows scrollbars. This is useful when creating applications with HMI because some of the standard controls get the scrollbar size information from the operating system.

Figure 74
Configuring Scrollbar

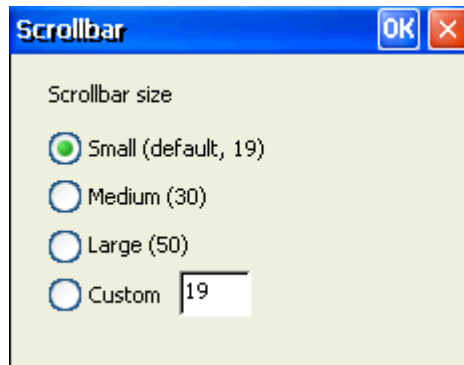

From the window, just select the desired size of the scrollbars and confirm.

6.1.8 System Reboot

The utility allows to reboot the system.

Figure 75
System Reboot

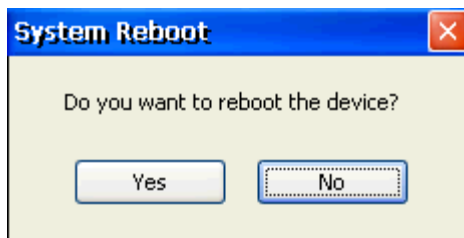

6.1.9 Assign network settings via text file to the USB stick

You have the option of assigning the network settings by using a USB stick that contains a file called IPConfig.csv. The CSV file must be formatted as follows:

DHCP, IP address, subnet, gateway

Here are a few examples:

1	0,172.19.17.27	0,172.19.17.27, 255.255.255.0
	0,172.19.17.27,255.255.255.0,172.19.16.1	1,172.19.17.27

The program looks for a CSV file called Ipconfig.csv, which is located in the same path and starts as soon as the USB stick is inserted.

SECTION **7**

Maintenance and care

7.1 Calibration of the touchscreen

The touchscreen of the system has only to be recalibrated in a few cases, e. g. update of the operating system.

To calibrate the touchscreen:

- Go in control panel.

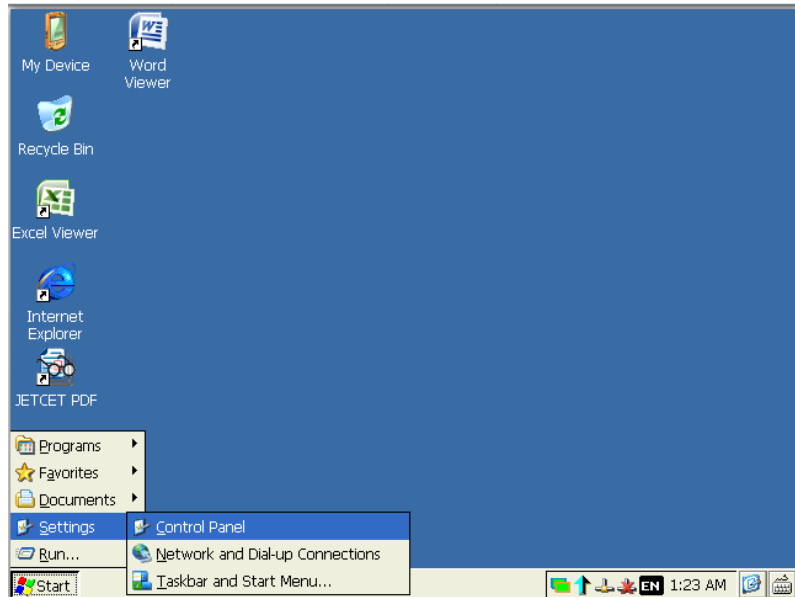

Figure 76
Calibration of the touchscreen

- Open the "Stylus" application.

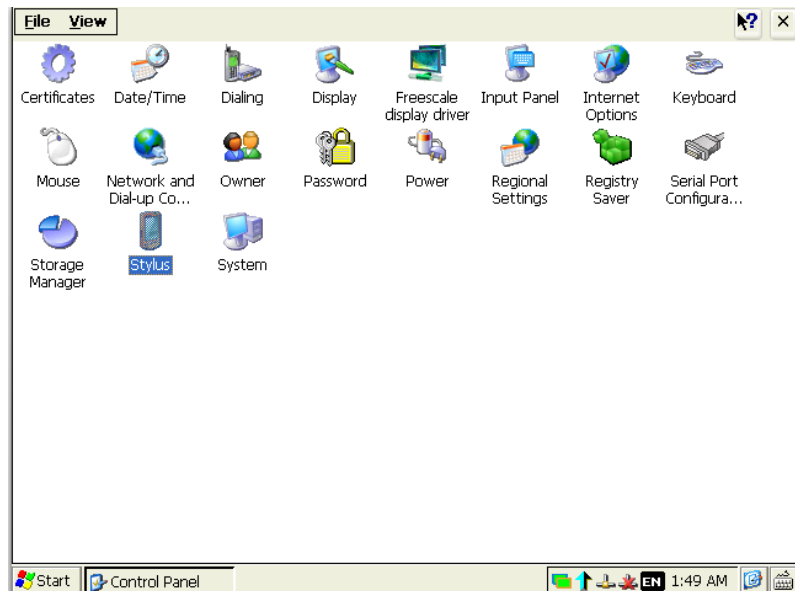
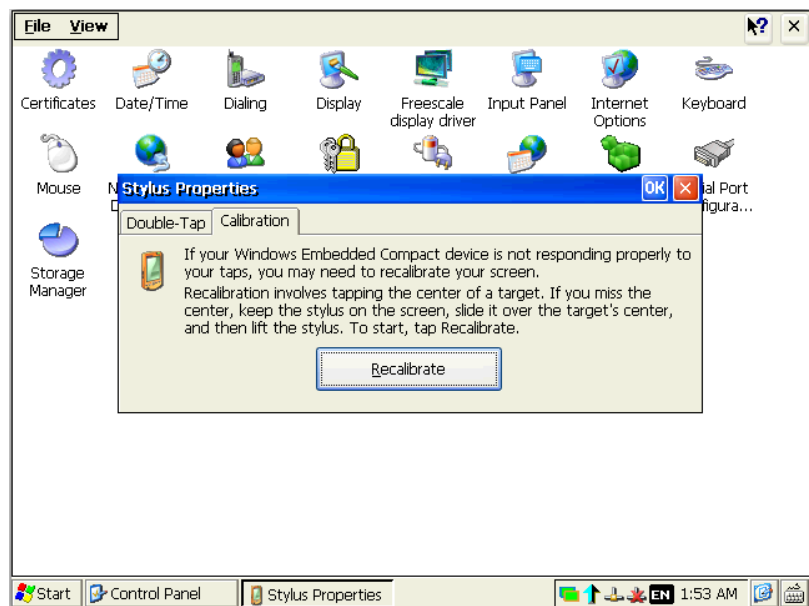

Figure 77
Calibration of the touchscreen

The following window will appear.

Figure 78
Calibration of the touchscreen



- Click on the “Recalibrate” button and follow the instructions.

7.2 Maintaining & cleaning

The system is designed for maintenance-free operation except for the replacing of the battery backup when necessary. It is recommended to clean the touchscreen with a damp cleaning cloth and a display cleaning solution.



Note: Clean the front panel of the system with a soft damp cloth only.



Attention: Do not use detergents, solvents, cleaners or objects that could scratch the surface.



Attention: Switch off the power before any cleaning operation.

7.2.1 Procedure

Proceed as follows:

- a) Switch off the C6 S14 device or lock the touch screen.
- b) Spray the cleaning product onto a cleaning cloth.
- c) Do not spray directly onto the display.
- d) Clean the display from the screen edge inwards.

7.2.2 Removing the rear cover for access to the motherboard

Tool required	Action
Screwdriver 2.5mm 	Screw / unscrew n.2 fixing screws
Box spanner 2.5mm	Screw / unscrew n.4 SUB-D screws

- Turn off the system and disconnect the power supply.
- On the side of the system remove the 2 fixing screws of the cover.

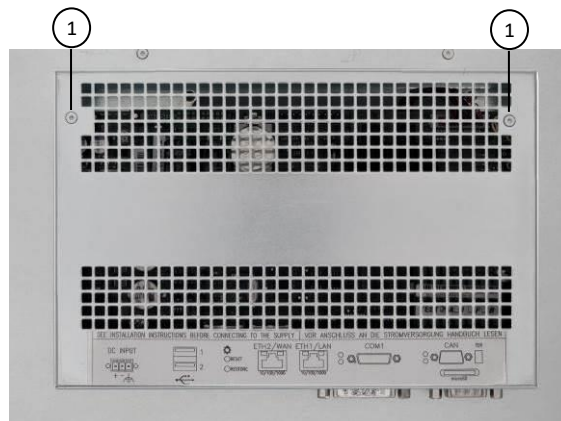

Figure 79
Backup battery replacement

① Screw to be removed

- Remove the 4 screws as indicated in the figure.

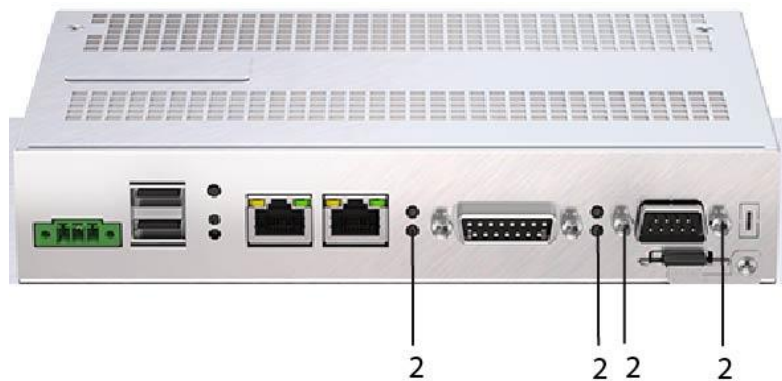

Figure 80
Backup battery replacement

② SUB-D screws to be removed

- Remove the cover.

Figure 81
Backup battery replacement



- Now the motherboard is accessible.

Figure 82
Backup battery replacement

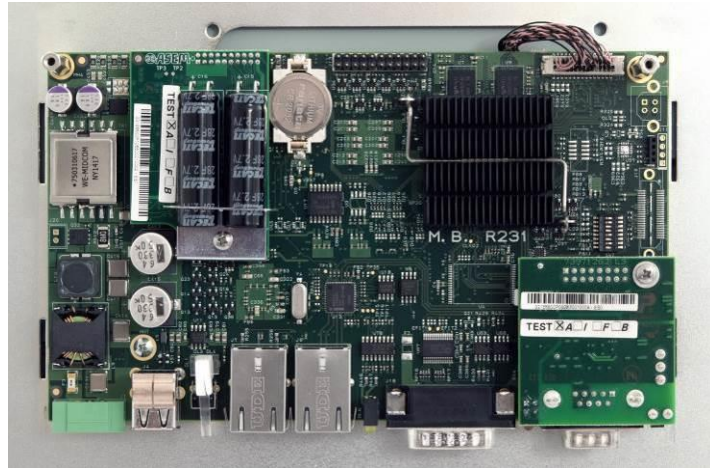

7.2.3 Backup battery replacement (BR2032 3V)

Tool required	Action
Plastic screwdriver 	Pull out the battery holder.

- Follow the procedure described in paragraph 6.2.2. to access the motherboard.
- Locate the Backup battery.

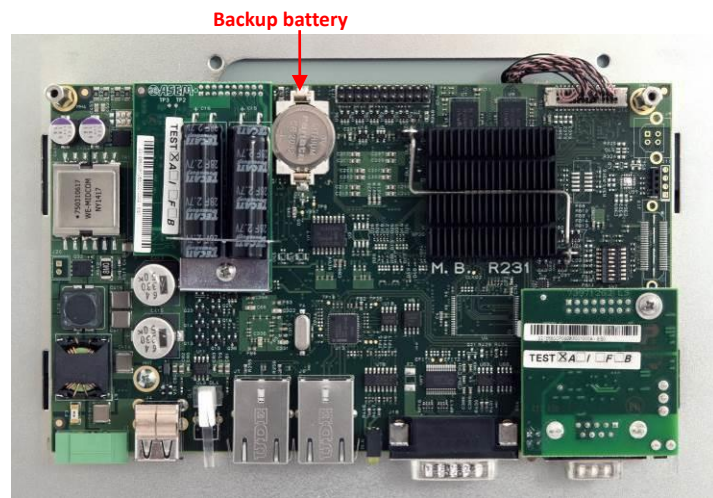

Figure 83
Backup battery replacement

- Using a screwdriver (not provided) carefully pull out the battery holder.

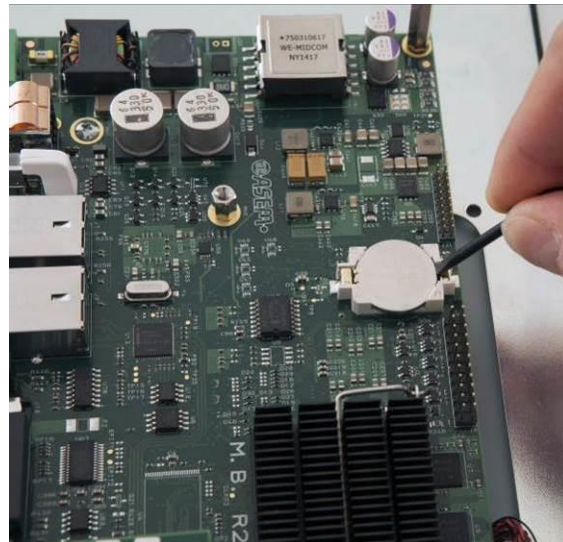



Figure 84
Backup battery detail

- Remove the battery and replace it with one of the same model (BR2032 3V).

7.2.4 Micro UPS Backup battery replacement

Tool required	Action
Screwdriver 2.5mm 	Screw / unscrew n.1 fixing screws

- Follow the procedure described in paragraph 6.2.2. to access the motherboard.
- Locate the Micro UPS module position.

Micro UPS module

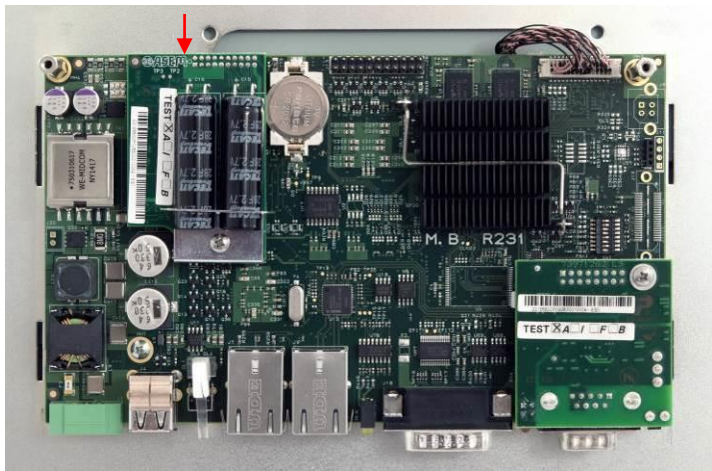

Figure 85
Backup battery replacement

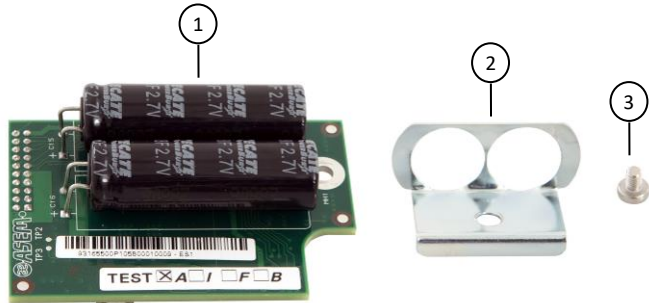
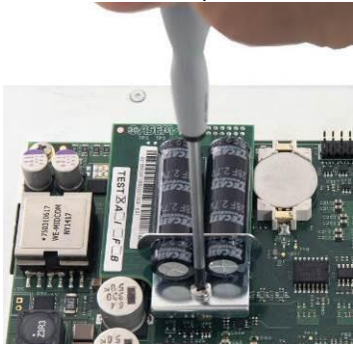

Figure 86
Backup battery replacement

- ① Micro UPS module
- ② Retainer
- ③ Screw

- Remove the screw as indicated in the picture.



- Remove the retainer as indicated in the picture.

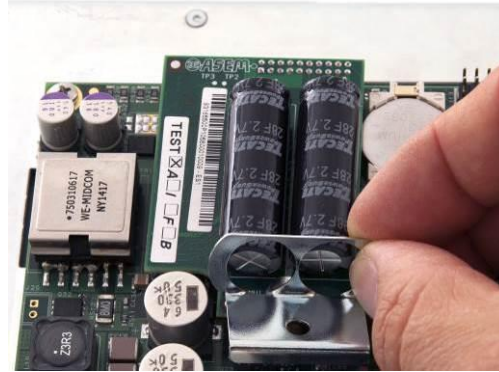

Figure 87
Backup battery replacement

- Remove the module as indicated in the picture.



Figure 88
Backup battery replacement

SECTION **8**
**Technical
specifications**

8.1 Technical specifications

Table 6
System hardware characteristics

	A	B	Power [W]
Basic configuration			10
HMI Software	●	●	-
	●	●	-
Remote Assistance	●	●	-
Front panel	●	●	-
Processor	●	●	-
Display & Touchscreen	●	●	-
	●		-0
	●		+2
	●		+2
	●		+4
	●		+11
	●		+7
	●		+13
	●		+8



Note

The power consumption of the configuration takes into consideration the maximum absorbed power of every component and does not include the consumption of the devices connected to the USB ports.



Note

The efficiency of the antennas and the extension cables is dependent on the quality of the radio frequency signal present at the installation site therefore we suggest not to use more than one extension cable between the antenna and the router.

8.1.1.1 Options

	A	B		
Communication ports	●	●	1 x RS-485 (DB9M) isolated with terminations • Without MPI protocol support	+1

8.1.2 C6 S14 resistive



Note

The power consumption of the configuration takes into consideration the maximum absorbed power of every component and does not include the consumption of the devices connected to the USB ports.



Note

Communication ports cannot be installed together.

		Power [W]
Basic configuration	LCD TFT 7" W • Touchscreen • Aluminium front panel • ARM Cortex A9 i.MX6 DualLite, 1 GHz • 1 GB RAM • 4GB eMMC PseudoSLC • 512kB MRAM • fanless • 24V DC power supply with MicroUPS function • Windows Embedded Compact 7 Pro with Datalight Reliance Nitro file system CONTROL Runtime WinCE/ARM • COMBIVIS HMI WinCE BASIC runtime • KEB COMBIVIS CONNECT PRO WinCE runtime • KEB System Manager • 12 months warranty	19
SoftPLC	● CONTROL Runtime Basic for WinCE/ARM runtime Protocols: EtherCAT Master, MODBUS TCP Master, MODBUS RTU Master, CANopen Master. Retentive variables: Automatic backup of retentive variables on MRAM at every system switch-off and/or power supply interruption	-
	● CONTROL Runtime PRO + SoftMotion v3.5x for WinCE/ARM runtime	-
	● CONTROL Runtime ADVANCED + SoftMotion + CNC v3.5x for WinCE/ARM runtime	-
HMI Software	● COMBIVIS HMI WinCE BASIC runtime	-
	● COMBIVIS HMI ADVANCED WinCE runtime	-
Remote Assistance	● KEB COMBIVIS CONNECT PRO WinCE runtime	-
Front panel	● Aluminium front panel • KEB logo sticker	-
Processor	● ARM Cortex A9 dual core processor • i.MX6 DualLite • 1 GHz • 400Mhz memory bus • Soldered on board	-
Display & Touchscreen	● 7" LCD TFT 15:9 • WVGA, 800x480, 16M colors • backlight LED 500 cd/m2 • viewing angle L:R/U:L (type): 70°:70°/60°:60° - 7" W Touchscreen • 4 wires resistive technology • controller integrated on board	-
	● 8,4" LCD TFT 4:3 • SVGA, 800x600, 256K colors • LED backlight, 400 cd/m2 • viewing angle L:R/U:L (type): 80°:80°/80°:80° - 8.4" Touchscreen • 5 wires resistive technology • controller integrated on board	-0
	● 10.1" W LCD TFT 16:10 • WXGA, 1280x800, 16M colors • LED backlight, 400cd/m2 • viewing angle L:R/U:L (type): 88°:88°/88°:88° 10.1" W Touchscreen 16:10 • 5 wires resistive technology • controller integrated on board	+2
	● 10.4" LCD TFT 4:3 • SVGA, 800x600, 16M colors • LED backlight , 400 cd/m2 • viewing angle L:R/U:L (type): 80°:80°/70°:70° 10.4" Touchscreen 4:3 • 5 wires resistive technology • controller integrated on board	+2
	● 12.1" LCD TFT 4:3 • SVGA, 800x600, 16M colors • LED backlight, 450 cd/m2 • viewing angle L:R/U:L (type): 80°:80°/65°:75° - 12.1" Touchscreen • 5 wires resistive technology • controller integrated on board	+4
	● 12.1" LCD TFT 4:3 • XGA, 1024x768, 16M colors • LED backlight, 600 cd/m2 • viewing angle L:R/U:L (type): 80°:80°/70°:70° - 12.1" Touchscreen • 5 wires resistive technology • controller integrated on board	+11
	● 12.1" W LCD TFT 16:10 • WXGA, 1280x800, 16M colors • LED backlight, 400 cd/m2 • viewing angle L:R/U:L (type): 88°:88°/88°:88° 12.1" W Touchscreen 16:10 • 5 wires resistive technology • controller integrated on board	+7
	● 15" LCD TFT 4:3 • XGA, 1024x768, 16M colors • LED backlight, 500 cd/m2 • viewing angle L:R/U:L (type): 85°:85°/85°:85° 15" Touchscreen 4:3 • 5 wires resistive technology • controller integrated on board	+13
	● 15.6" W LCD TFT 16:9 • 1366x768 (HD), 16M colors • LED backlight, 400 cd/m2 • viewing angle L:R/U:L (type): 85°:85°/80°:80° 15.6" W Touchscreen 16:9 • 5 wires resistive technology • controller integrated on board	+8
Microups & MRAM	● MicroUPS, with backup function for micro interruptions max 500ms and 512kB MRAM (Magneticretentions) for retentive variables	

8.1.2.1 Options

Communication ports	●	1 x RS-485 (DB9M) isolated with terminations • without MPI protocol support	1
	●	1 x CAN isolated channel (DB9M) with terminations	1

8.1.3 C6 S14 capacitive



Note

The power consumption of the configuration takes into consideration the maximum absorbed power of every component and does not include the consumption of the devices connected to the USB ports.



Note

Communication ports cannot be installed together.

			Power [W]	
Basic configuration	LCD TFT 7" W • P-CAP projected capacitive Touchscreen • Aluminium and tempered glass TrueFlat front panel • ARM Cortex A9 i.MX6 DualLite, 1 GHz • 1GMB RAM • 4GB eMMC PseudoSLC • 512kB MRAM • fanless • 24V DC power supply with MicroUPS function • Windows Embedded Compact 7 Pro with Datalight Reliance Nitro file system • CONTROL Runtime x WinCE/ARM • COMBIVIS HMI WinCE BASIC runtime • KEB COMBIVIS CONNECT PRO WinCE runtime • KEB System Manager • 12 months warranty		19	
	A	B		
SoftPLC	●	●	CONTROL Runtime Basic x for WinCE/ARM runtime Protocols: EtherCAT Master, MODBUS TCP Master, MODBUS RTU Master, CANopen Master. Retentive variables: Automatic backup of retentive variables on MRAM at every system switch-off and/or power supply interruption	-
	●	●	CONTROL Runtime PRO + SoftMotion v3.5x for WinCE/ARM runtime	-
	●	●	CONTROL Runtime ADVANCED +SoftMotion + CNC v3.5x for WinCE/ARM runtime	-
HMI Software	●	●	COMBIVIS HMI WinCE BASIC runtime	-
	●	●	COMBIVIS HMI ADVANCED WinCE runtime	-
Remote Assistance	●	●	KEB COMBIVIS CONNECT PRO WinCE runtime	-
Front panel	●	●	Aluminium front panel • KEB logo sticker	-
Processor	●	●	ARM Cortex A9 dual core processor • i.MX6 DualLite • 1 GHz • 400Mhz memory bus • Soldered on board	-
Display & Touchscreen		●	7" LCD TFT 15:9 • WVGA, 800x480, 16M colors • backlight LED 500 cd/m2 • viewing angle L:R/U:L (type): 70°:70°/60°:60° 7" W Touchscreen 15:9 • P-CAP projected capacitive multi-touch touchscreen	-
	●		10.1" W LCD TFT 16:10 • WXGA, 1280x800, 16M colors • LED backlight, 400cd/m2 • viewing angle L:R/U:L (type): 88°:88°/88°:88° 10.1" W Touchscreen 16:10 • P-CAP projected capacitive multi-touch touchscreen	+2
	●		12.1" W LCD TFT 16:10 • WXGA, 1280x800, 16M colors • LED backlight, 400 cd/m2 • viewing angle L:R/U:L (type): 88°:88°/88°:88° 12.1" W Touchscreen 16:10 • P-CAP projected capacitive multi-touch touchscreen	+7
	●		15.6" W LCD TFT 16:9 • 1366x768 (HD), 16M colors • LED backlight, 400 cd/m2 • viewing angle L:R/U:L (type): 85°:85°/80°:80° 15.6" W Touchscreen 16:9 • P-CAP projected capacitive multi-touch touchscreen	+8
Microups & MRAM	●	●	MicroUPS, with backup function for microinterruptions max 500ms and 512kB MRAM (Magnetic RAM) for retentive variables	

8.1.3.1 Options

		A	B	
Communication ports	●	●	1 x RS-485 (DB9M) isolated with terminations • without MPI protocol support	+1
	●	●	1 x CAN isolated channel (DB9M) with terminations	1

8.1.4 C6 S14 Family Technical specifications

Front panel	C6 S14 resistive	Aluminium ▪ KEB logo sticker
	C6 S14 capacitive	Aluminium and tempered glass TrueFlat
Touchscreen	C6 S14 resistive	4/5 wires resistive technology
	C6 S14 capacitive	projective capacitive touch-screen
Frontal protection		IP66, Enclosure type 4X (Indoor use only)
Operating System		Microsoft Windows Embedded Compact 7 Pro license with Datalight Reliance Nitro file system ▪ Microsoft olographic sticker
Software	HMI	COMBIVISHMI WinCE BASIC / ADVANCED runtime license with KEB sticker
	Control	CONTROL Runtime x for WinCE/ARM runtime ▪ license with 3S sticker
	Remote assistance	KEB COMBIVIS CONNECT WinCE PRO runtime license with KEB sticker
	Utility	KEB System Manager
Power supply		Input voltage 18÷36V DC Isolated power supply section integrated on board
Motherboard		"All-In-One" type ▪ KEB R231
Processor		ARM Cortex A9 dual core ▪ i.MX6 DualLite ▪ 1 GHz, 400 MHz system memory bus ▪ GPU (Graphic Processor Unit) integrated
RAM memory		1 GB DDR3-800 ▪ Soldered on board
Mass storage		eMMC (Solid State Disk) 4GB Pseudo-SLC, 8bit, file system organization ▪ for projects and applications
Retentive memory		512kB MRAM (Magneticresistive RAM) for backup of retentive and persistent variables
SD slot		1 x Slot MicroSD integrated on board ▪ external access
Rear access interfaces		2 x Ethernet 10/100/1000 Mbps (RJ45) 2 x USB 2.0 (Type-A / host)
Rear access serial interfaces		1 x RS-232/422/485 (DB15M) with MPI protocol support up to 187,5Kbit/s Optional 1 x RS-485 isolated (DB9M) without MPI protocol support
Environmental specifications		Operating temperature: 0° ÷ +50°C Storage temperature: -20° ÷ +60°C Humidity: 80% (non-condensing)

8.1.5 CONTROL Runtime WinCE/ARM for C6 S14 main features

Table 7
CONTROL Runtime WinCE/ARM for C6 S14 key features

PLC programming	IEC61131-3, CONTROL Runtime
Supported protocols	EtherCAT Master, MODBUS TCP Master, MODBUS RTU Master
Variables backup	Retentive: 64kByte Persistent: 64kByte Management: Automatic backup of retentive variables on MRAM at every system switch-off and/or power supply interruption
Main performances	Cycle time: ≥ 2 ms Jitter: $\pm 600\mu$ s Fieldbus: Only one, no gateway admitted

8.1.6 COMBIVIS HMI runtimes differences

Table 8
COMBIVIS HMI runtimes differences

	BASIC	ADVANCED
RealTime DB (max, byte)	1.024	8.192
Alarms (max)	1.024	4.096
Recipes / Data Logger (ODBC)	Max 2	Unlimited
Communication drivers	Max 2	Max 4
Alarm notification (SMS, E-Mail)		•
SMS notification via SMPP protocol		SMS using Internet gateway
Web Clients		Max 4 clients connected
COMBIVIS studio HMI Mobile		•

8.1.7 COMBIVIS CONNECT PRO main features

Table 9
KEB COMBIVIS CONNECT PRO key features

Control Center application to access the service with intuitive and ergonomic user interface for a comprehensive machine park management
Optimized VPN with access limited to the remote device with COMBIVIS connect Runtime
Optimized VPN with entire access to the complete remote device sub-network and serial pass-through

8.1.8 KEB System Manager Control Panel utilities

Table 10
ASM Control Panel utilities

Backup&Restore	Complete system cloning or selective backup and restore of the installed software
Antialiasing	Softens the characters matrix
Screensaver	Display brightness control or display switch off after an inactivity period
Touch Buzzer	Enable touch sound-feedback
eMMC Usage	Check the eMMC memory usage and evaluate the expected endurance
Kiosk Mode	Hide the O.S. explorer interface and run COMBIVIS HMI runtime in 'kiosk' mode
Language Set-tings	Easy installation of not european languages characters in HMI applica-tions
Scrollbar	Allows to change the size of the scroll bars
System Reboot	Reboot the system without switching off the power supply

Table 11
7.0" W Display characteristics

8.1.9 7.0"W Display characteristics

7" Display characteristics	
Dimensions	7.0"W (15:9)
Technology	TFT active matrix
Active area	152.4 x 91.44 mm
Resolution	800 x 480 pixels
Display color	262K / 16.2 M colors
Pixel Pitch	0.1905 (W) x 0.1905 (H) mm
Luminance	500 cd/m ² (Note 1)
Horizontal viewing angle (left + right)	70°+70°
Vertical viewing angle (up + down)	60°+60°
Contrast ratio	600:1 (Typ.)
Response time (Rise / Fail)	16 ms (Typ.)
Backlight	LED
LED lifetime (Note 2)	50.000h @ default (Note 3) and max Tamb

Table 12
8.4" Display characteristics

8.1.10 8.4" Display characteristics

8.4" Display characteristics	
Dimensions	8,4" (4:3)
Technology	TFT active matrix
Display area	170.4 (W) x 127.8 (H) mm
Resolution	800 x 600 pixels
Display color	16.2 M colors
Pixel Pitch	0.213 (W) x 0.213 (H) mm
Luminance	400 cd/m ² (Note 1)
Horizontal viewing angle (left + right)	80°+80°
Vertical viewing angle (up + down)	80°+80°
Contrast ratio	800:1 (Typ.)
Response time (Rise + Fail)	18 ms (Typ.)
Backlight	LED
LED lifetime (Note 2)	50.000h @ default (Note 3) and max Tamb

Table 13
10.1" Display characteristics

8.1.11 10.1" Display characteristics

10.4" Display characteristics	
Dimensions	10.1" (16:10)
Technology	TFT active matrix
Display area	216.96 (W) x 135.6 (H) mm
Resolution	1280 x 800 pixels
Display color	16.7M colors
Pixel Pitch	0.1695 (W) x 0.1695 (H) mm
Luminance	400 cd/m ² (Note 1)
Horizontal viewing angle (left + right)	88°+88°
Vertical viewing angle (up + down)	88°+88°
Contrast ratio	800:1 (Typ.)
Response time (Rise + Fail)	25 ms (Typ.)
Backlight	LED
LED lifetime (Note 2)	100.000h @ default (Note 3) and max Tamb

8.1.12 10.1" W Display characteristics

Table 14
10.1" W Display characteristics

10.4" Display characteristics	
Dimensions	10.1" (16:10)
Technology	TFT active matrix
Display area	216.96 (W) x 135.6 (H) mm
Resolution	1280 x 800 pixels
Display color	16.7M colors
Pixel Pitch	0.1695 (W) x 0.1695 (H) mm
Luminance	400 cd/m ² (Note 1)
Horizontal viewing angle (left + right)	88°+88°
Vertical viewing angle (up + down)	88°+88°
Contrast ratio	800:1 (Typ.)
Response time (Rise + Fail)	25 ms (Typ.)
Backlight	LED
LED lifetime (Note 2)	70,000h @ default (Note 3) and max Tamb

8.1.13 10.4" Display characteristics

Table 15
10.4" Display characteristics

10.4" Display characteristics	
Dimensions	10.4" (4:3)
Technology	TFT active matrix
Display area	211.2 (W) x 158.4 (H) mm
Resolution	800 x 600 pixels
Display color	262K / 16.2M colors
Pixel Pitch	0.264 (W) x 0.264 (H) mm
Luminance	400 cd/m ² (Note 1)
Horizontal viewing angle (left + right)	80°+80°
Vertical viewing angle (up + down)	70°+70°
Contrast ratio	700:1 (Typ.)
Response time (Rise / Fail)	16 ms (Typ.)
Backlight	LED
LED lifetime (Note 2)	50,000h @ default (Note 3) and max Tamb

8.1.14 12.1" (SVGA) Display characteristics

Table 16
12.1" (SVGA) Display characteristics

12.1" Display characteristics	
Dimensions	12.1" (4:3)
Technology	TFT active matrix
Display area	246.0 (W) x 184.5 (H) mm
Resolution	800 x 600 pixels
Display color	262K / 16.7M colors
Pixel Pitch	0.3075 (W) x 0.03075 (H) mm
Luminance	500 cd/m ² (Note 1)
Horizontal viewing angle (left + right)	80°+80°
Vertical viewing angle (up + down)	60°+80°
Contrast ratio	800:1 (Typ.)
Response time (Rise + Fail)	16 ms (Typ.)
Backlight	LED
LED lifetime (Note 2)	50,000h @ default (Note 3) and max Tamb

8.1.15 12.1"W (WXGA) Display characteristics

Table 17
12.1"W (WXGA) Display characteristics

12.1" Display characteristics	
Dimensions	12.1"W (16:10)
Technology	TFT active matrix
Active area	261,12 x 163,2 mm
Resolution	1280 x 800 pixels
Display color	262K/16.2M colors
Pixel Pitch	0.204 (W) x 0.204 (H) mm
Luminance	400 cd/m ² (Note 1)
Horizontal viewing angle (left + right)	88°+88°
Vertical viewing angle (up + down)	88°+88°
Contrast ratio	1000:1 (Typ.)
Response time (Rise / Fail)	25 ms
Backlight	LED
LED lifetime (Note 2)	50,000h @ default (Note 3) and max Tamb

8.1.16 15.0" (XGA) Display characteristics

Table 18
15.0" (XGA) Display characteristics

15.0" Display characteristics	
Dimensions	15.0" (4:3)
Technology	TFT active matrix
Display area	304.1 (W) x 228.1 (H) mm
Resolution	1024 x 768 pixels
Display color	16.2M colors
Pixel Pitch	0.297 (W) x 0.297 (H) mm
Luminance	500 cd/m ² (Note 1) (Typ.)
Horizontal viewing angle (left + right)	85°+85°
Vertical viewing angle (up + down)	85°+85°
Contrast ratio	1500:1 (Typ.)
Response time (Rise / Fail)	35 ms (Typ.)
Backlight	LED
LED lifetime (Note 2)	50,000h @ default (Note 3) and max Tamb

8.1.17 15.6"W (WXGA) Display characteristics

Table 19
15.6" W Display characteristics

15.6" Display characteristics	
Dimensions	15.6" (16:9)
Technology	TFT active matrix
Active area	344.2 (W) x 193.5 (H) mm
Resolution	1366 x 768 pixels
Display color	16.7M colors
Pixel Pitch	0.252 (W) x 0.252 (H) mm
Luminance	400 cd/m ² (Note 1)
Horizontal viewing angle (left + right)	85°+85°
Vertical viewing angle (up + down)	80°+80°
Contrast ratio	500:1 (Typ.)
Response time (Rise / Fall)	8 ms (Typ.)
Backlight	LED
LED lifetime (Note 2)	50,000h @ default (Note 3) and max Tamb

Note 1:

At maximum (100%) brightness setting.

Note 2:

After the LED life time, the backlight luminance may be reduced up to the 50% of the initial value.

Note 3:

The default backlight value is set at 80% of the maximum brightness by the operating system.

Note, that the user can modify the backlight brightness, using the related operating system mask.

At 25°C, the above-indicated LED life is also guaranteed at 100% backlight brightness; instead, at higher ambient temperature and 100% backlight brightness, LED life time will decrease.

8.2 Certificates and approvals

Table 20
Certificates & approvals



EU DECLARATION OF CONFORMITY

Document No. / month.year: ce_ca_remv-C6J-a_en.docx / 01.2019

Manufacturer:	KEB Automation KG Südstraße 38 32683 BARNTRUP Germany	
Product type	Control type Control size Voltage category	yyC6Jxx – xxxx yy = 00 for Stand Alone PC or yy = 01 to FF for TouchPanel PC x = any letter or number 24 Vdc

The above given product is in accordance with the following directives of the European Union

Number:	EMC : 2014 / 30 / EU
Text:	Directive on the approximation of the laws of the Member States relating to electromagnetic compatibility.
Number:	Hazardous Substances: 2011 / 65 / EEC (Incl, 2015 / 863 / EU)
Text:	Directive on the approximation of the laws of the Member States relating on the restriction of the use of certain hazardous substances in electrical and electronic equipment.

Responsible: KEB Automation KG
Südstraße 38
32683 BARNTRUP

Place, date Barntrup, 26, December 2018

Issued by:

	
L. A. W. Hovestadt / Conformance Officer	W. Wiele / Technical Manager

This declaration certifies the conformity with the named directives, but does not contain any assurance of quality.

The safety instructions, described in the instruction manual are to be followed.

KEB Automation KG, Südstr. 38, D-32683 Barntrup www.keb.de E-Mail info@keb.de Tel. +49 5203 401-0 Fax +49 5203 401-110

EU DECLARATION OF CONFORMITY



Annex 1

Document No. / month, year: ca_ca_remwC6J_e_en.docx / 01.2019

Product type	Control type	yyC6Jxx – xxxx
	Control size	yy = 00 for Stand Alone PC or yy = 01 to FF for TouchPanel PC
	Voltage category	x = any letter or number 24 Vdc

The conformity of the above given product to the European Directive 2014/30/EU (for electromagnetic compatibility) is given by complete approval / testing to the following European harmonized standards. For not exceeding the required limits or minimum levels of immunity it is necessary to use observe the given wiring specifications from available instruction manual.

EN 61326-1 Version 2013	Text Electrical equipment for measurement, control and laboratory use – EMC requirements – Part 1: General requirements
EN 61000 – 3 – 2 Version 2014	Electromagnetic compatibility – Part 3-2 Limits – Limits for harmonic current emissions (equipment input current ≤ 16A per phase)
EN 61000 – 3 – 3 Version 2013	Electromagnetic compatibility – Part 3-3 Limits – Limits of voltage changes, voltage fluctuations and flicker in public low voltage systems, for equipment with rated current ≤ 16A per phase
EN 61000 – 6 – 2 Version 2005	Electromagnetic compatibility (EMC) – Part 6-2: Generic Standard – Immunity standard for industrial environment
EN 55011 Version 2009 + A1 – 2010	Industrial, scientific and medical equipment, radio-frequency disturbance characteristics: Limits and methods of measurement

The conformity of the above given product to the European Directive 2011/65/EU with changes of 2015/863/EU (for restrictions of the use for certain hazardous substances in electrical and electronic equipment) is given by qualification of components and manufacturing process within the ISO 9001 QM system. The necessary information and declarations are documented and memorized.

The above given product was developed, manufactured and tested within an internal quality management system. This ISO 9001 QM system was approved by:

Notified body:	TÜV – CERT
Adress:	Zertifizierungsstelle des RWTÜV Steubenstrasse 53 D – 45138 Essen
No. of approval:	041 004 500
Dated:	20,10,1994
Valid until:	December 2021

UL Product iQ™



NRAQ.E479848 - Programmable Controllers Programmable Controllers

[See General Information for Programmable Controllers](#)

KEB AUTOMATION KG
SUEDSTRASSE 38
32683 BARNTRUP, GERMANY

E479848

Investigated to ANSI/UL 508

Front-Panel Mounting Display, for use on a flat surface of a type 1 and 4X INDOOR enclosure, Model(s) aaCGAF1-44xx Where "a" may be any character for different sizes of panel display. Where "xx" can be 02 or 05 representing SW Configuration.

aaCGAF1-45xx Where "a" may be any character for different sizes of panel display. Where "xx" can be 02 or 05 representing SW Configuration.

Open type, Programmable controllers Model(s) 00C6CB1-0100, 00C6CB1-0200, 00C6CB1-0300, 00C6CB1-0400, 00C6CB1-0500, 00C6CB1-0600, 00C6CB1-0700, 00C6CB1-0800, 00C6CB1-0900, 00C6CB1-1000, 00C6CB1-1100, 00C6CB1-1200, 00C6CB1-1300, 00C6CB1-1400, 00C6CB1-1600, 00C6CB1-1700, 00C6CB1-1800, 00C6CB1-1900, 00C6CB1-2000, 00C6CB1-2100, 00C6CC1-0100, 00C6CC1-0200, 00C6CC1-0300, 00C6CC1-0400, 00C6CC1-0500, 00C6CC1-0700, 00C6CC1-0800, 00C6CC1-0900, 00C6CC1-1000, 00C6CC1-1100, 00C6CC1-1200, 00C6CC1-1300, 00C6CC1-1400, 00C6CC1-1500, 00C6CC1-1600, 00C6CC1-1700, 00C6CC1-1800, 00C6CC1-1900, 00C6CE1-0100, 00C6CE1-0200, 00C6CF1-0200, 00C6CH1-0100, 00C6CH1-0100, 00C6HA1-xxxx, 00C6HB1-xxxx

Programmable Controllers Model(s) 00C6CA1-0100 where xy may be 00,02,03,04,06,07,08,09 or 10.

00C6CF1-0100 where xy may be 00,02,03,04,06,07,08,09 or 10.

Programmable controllers Model(s) aaCGHA1-xxxx Where "a" may be any character for different sizes of panel display.

aaCGHB1-xxxx Where "a" may be any character for different sizes of panel display.

Investigated to UL 61010-1 and UL 61010-2-201

Programmable Automation Controller, PAC Model(s) C6 Smart, xxCGGx-xxxx

Investigated to UL 61010-1, 3rd Edition and UL 61010-2-201, 1st Edition

Front-Panel Mounting or Open type Industrial PC Model(s) 00CGHM1-xxxx Where "xxxx" is a 4 digit / letter combination for different software configurations.

00CGHN1-xxxx Where "xxxx" is a 4 digit / letter combination for different software configurations.

aaCGHM1-xxxx Where "a" may be any character for different sizes of panel display. Where "xxxx" is a 4 digit / letter combination for different software configurations.

aaCGHN1-xxxx Where "a" may be any character for different sizes of panel display. Where "xxxx" is a 4 digit / letter combination for different software configurations.

Industrial PC Model(s) 00C6HL1-xxxx Where "xxxx" is a 4 digit / letter combination for different software configurations.

Industrial PC Model(s) 00C6HP1-xxxx Where "xxxx" is a 4 digit / letter combination for different software configurations.

00C6HQ1-xxxx Where "xxxx" is a 4 digit / letter combination for different software configurations.

Programmable controllers Model(s) aaCGIF1-110x Where "a" may be any character for different sizes of panel display. Where "x" is any digit representing Customer ID.

aaCGIF1-111x Where "a" may be any character for different sizes of panel display. Where "x" is any digit representing Customer ID.

aaCGIF1-112x Where "a" may be any character for different sizes of panel display. Where "x" is any digit representing Customer ID.

Investigated to UL 61010-1, 3rd Edition and UL 61010-2-201, 2nd Edition

Programmable Controllers, "Multi Fieldbus Interface C6 Remote I/O" Model(s) 00C6CH1-0200, 00C6CH1-0300, 00C6CH1-0400, 00C6CH1-0500

Investigated to

Industrial PC Model(s) 00C6HC1-xxxx

[Last Updated](#) on 2020-03-11

Der Umstand, dass der Name oder das Produkt eines Unternehmens in dieser Datenbank aufgeführt ist, garantiert nicht, dass die Herstellung der jeweiligen Produkte dem Follow-Up-Service von UL unterliegt. Nur Produkte mit UL-Zeichen gelten als zertifiziert und sind vom Follow-Up-Service von UL abgedeckt. Prüfen Sie daher stets, ob ein Produkt das UL-Zeichen trägt.

UL gestattet die Weiterverwendung der im Online-Zertifizierungsverzeichnis enthaltenen Materialien unter den folgenden Bedingungen: 1. Alle Anleitungen, Baugruppen, Konstruktionen, Designs, Systeme und/oder Zertifizierungen (Dateien) müssen vollständig und auf nicht irreführende Weise ohne Manipulation der Daten (oder Zeichnungen) dargestellt werden. 2. Bei Weiterverwendung von Materialien muss der Vermerk „Aus dem Online-Zertifizierungsverzeichnis mit Genehmigung von UL nachgedruckt“ stets mit angegeben werden. Darüber hinaus muss das nachgedruckte Material einen Urheberrechtsvermerk in folgendem Format enthalten: "© 2021 UL

8.3 Dimension drawings

8.3.1 7.0" W (resistive)

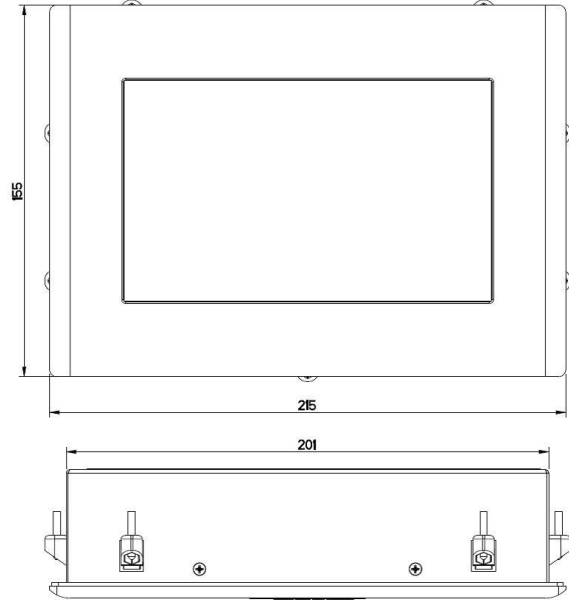

Figure 89
7.0" W (resistive)

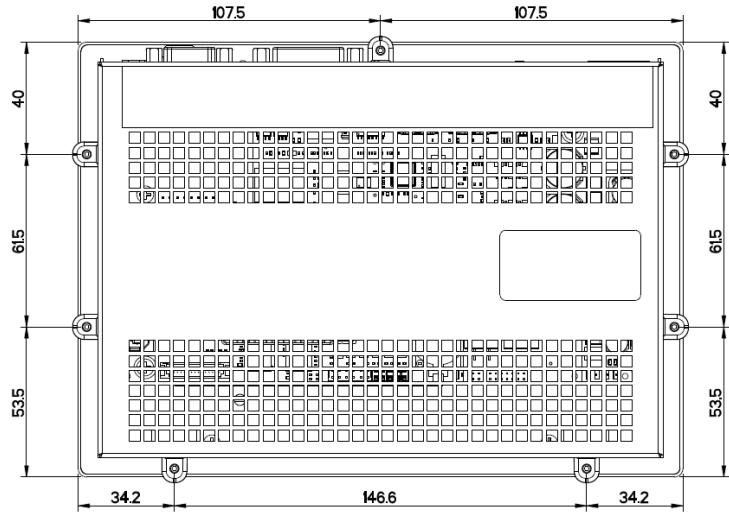
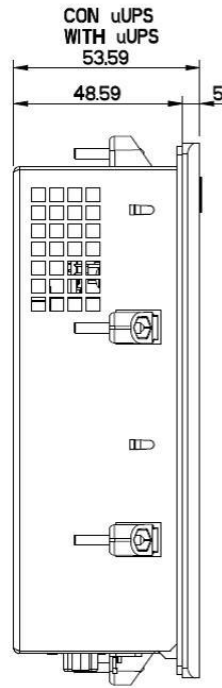

Figure 90
7.0" W (resistive)



8.3.2 7.0"W capacitive CUTOUT B

Figure 91
7.0" W (capacitive) CUTOUT B

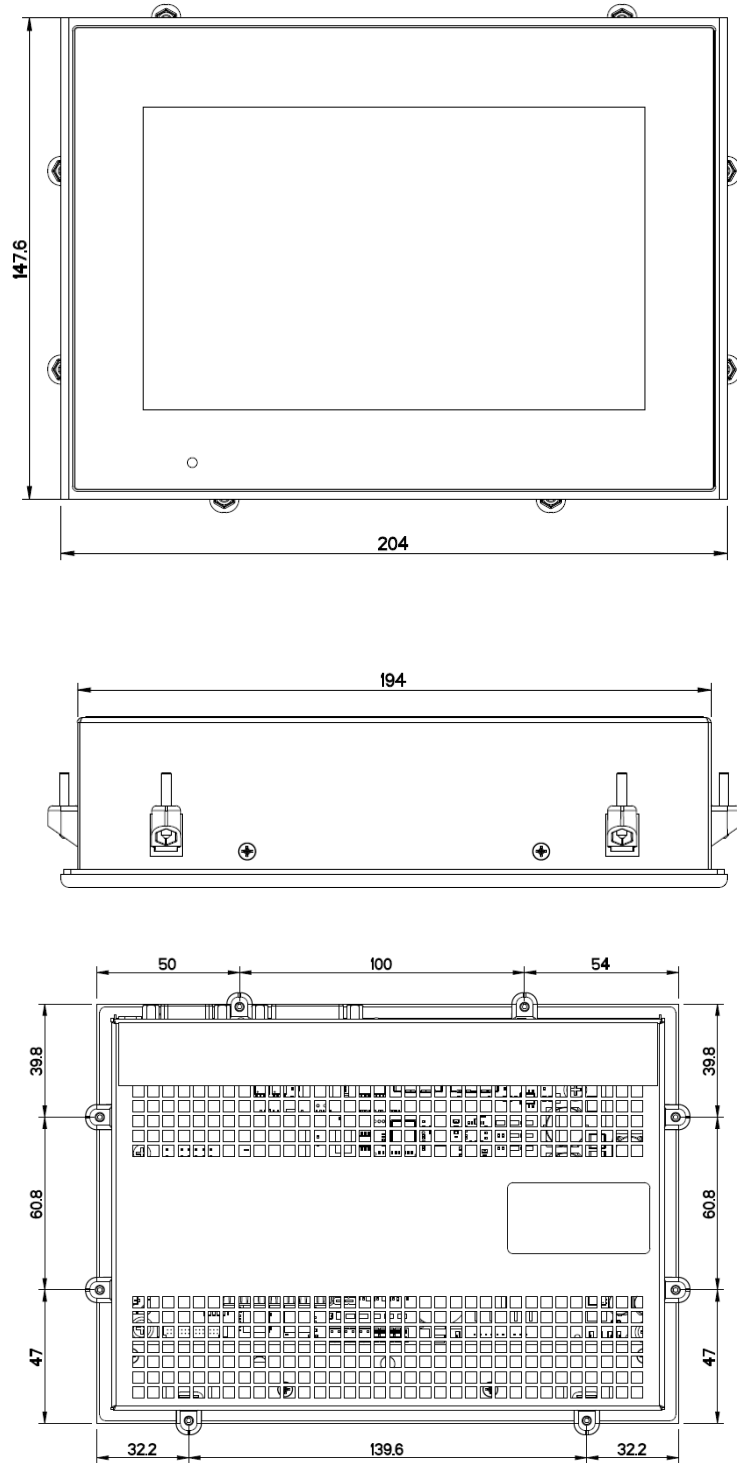
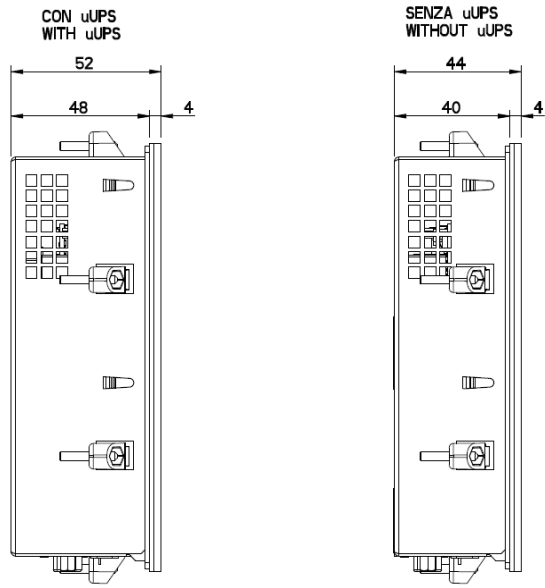

Figure 92
7.0" W capacitive CUT OUT B



8.3.3 8.4" (resistive)

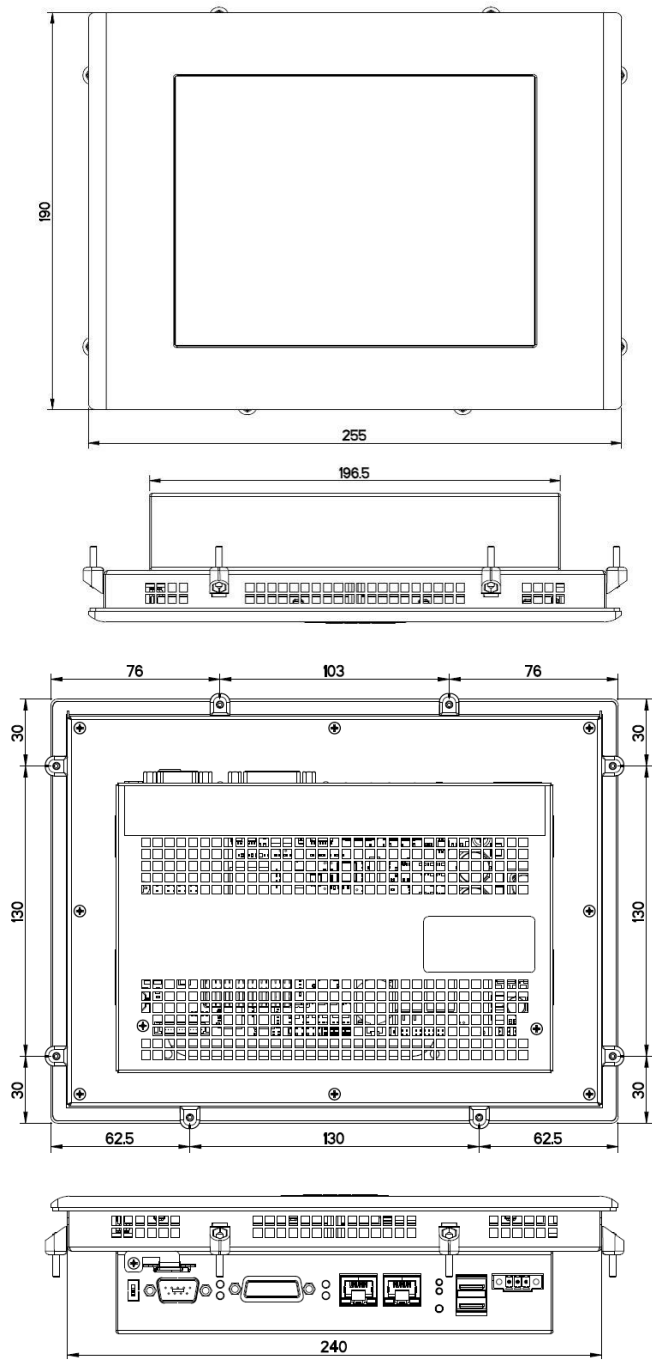
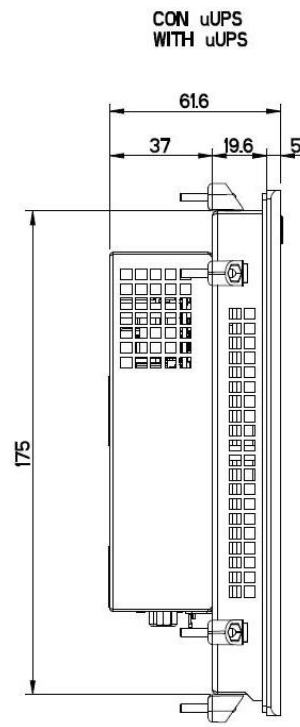

Figure 93
8.4" (resistive)

Figure 94
8.4" (resistive)



8.3.4 10.1" W (resistive)

Figure 95
10.1" W (resistive)

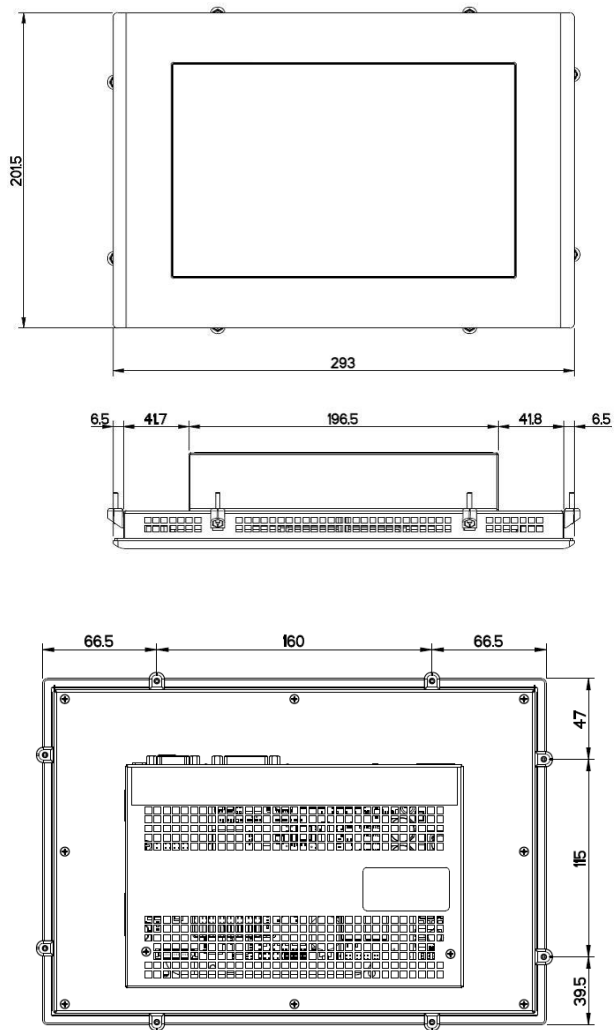
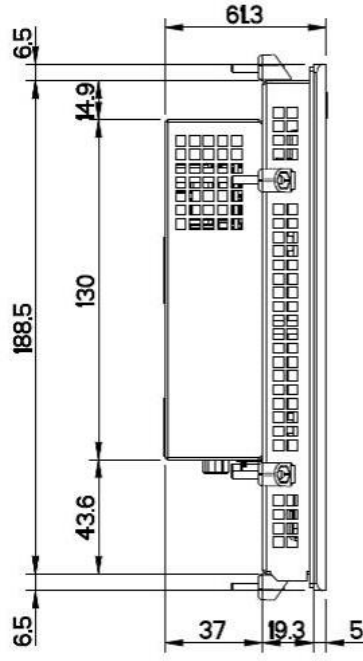

Figure 96
10.1" W (resistive)



WITH uUPS

8.3.5 C6 S14 - 10.1"W (capacitive)

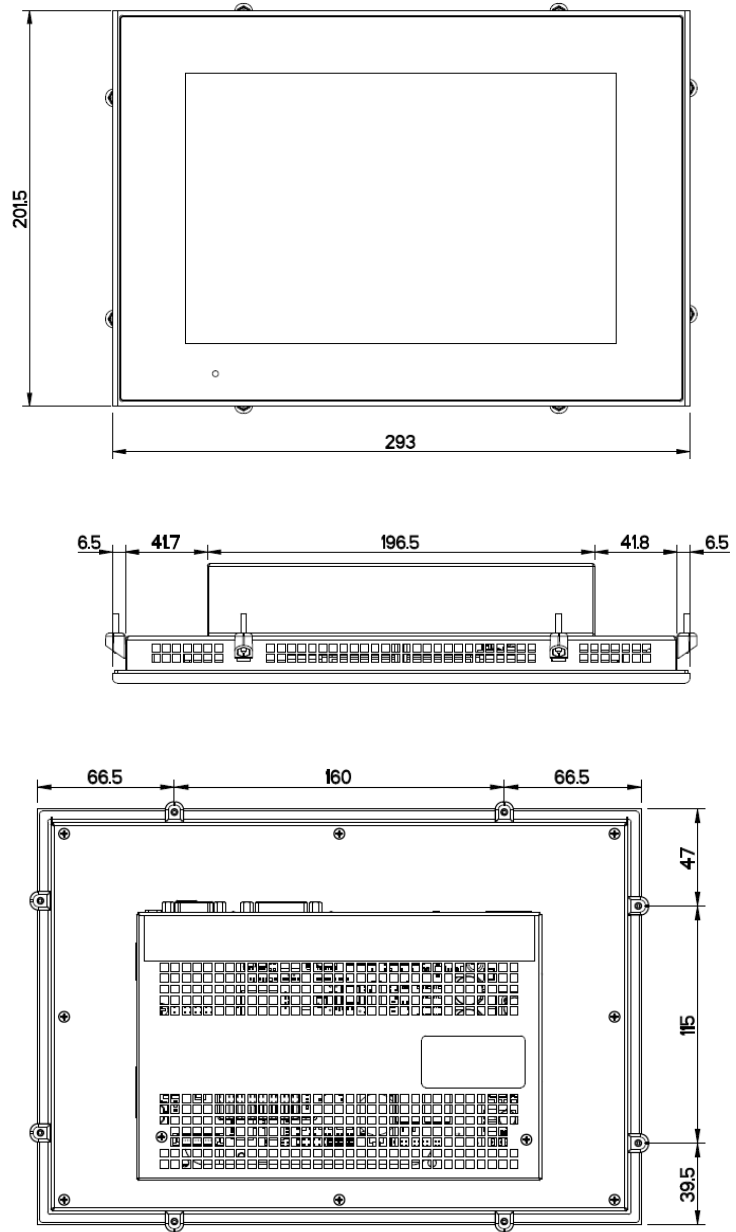
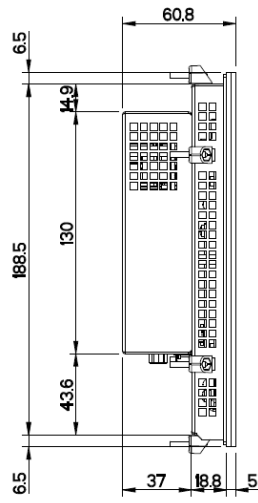
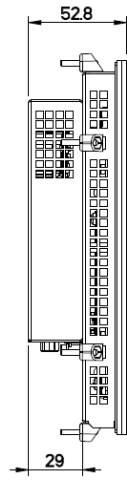

Figure 97
10.1" W (capacitive)

Figure 98
10.1" W (capacitive)



WITH uUPS



WITHOUT uUPS

8.3.6 10.4" (resistive)

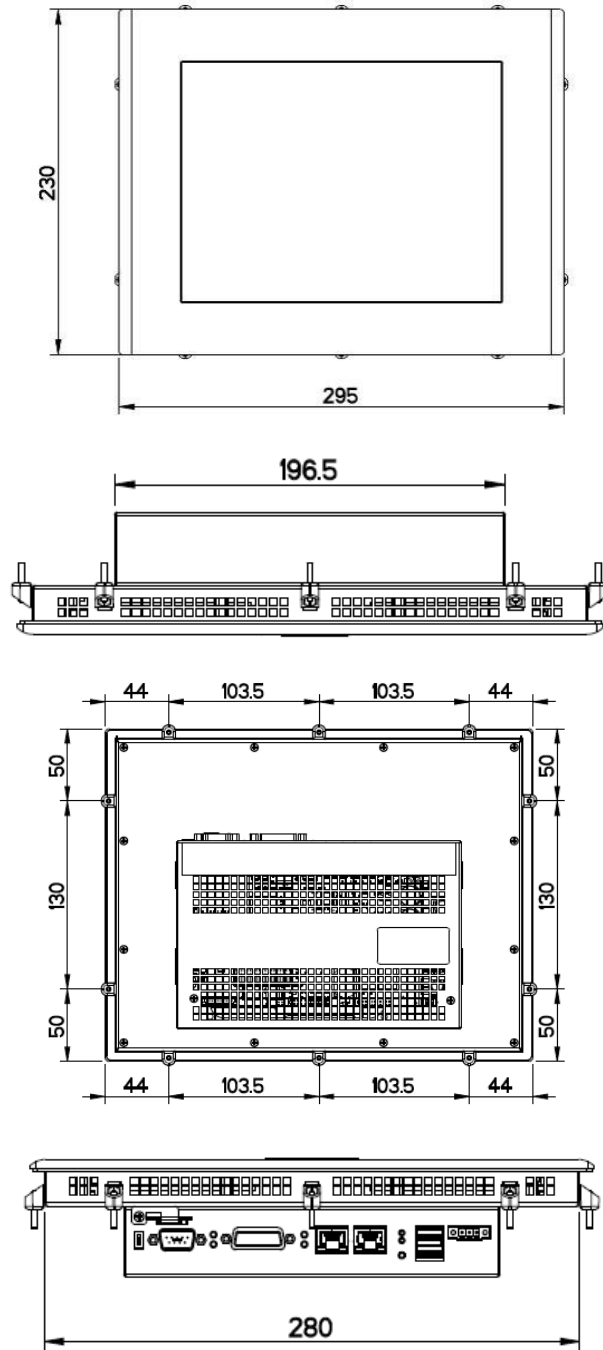
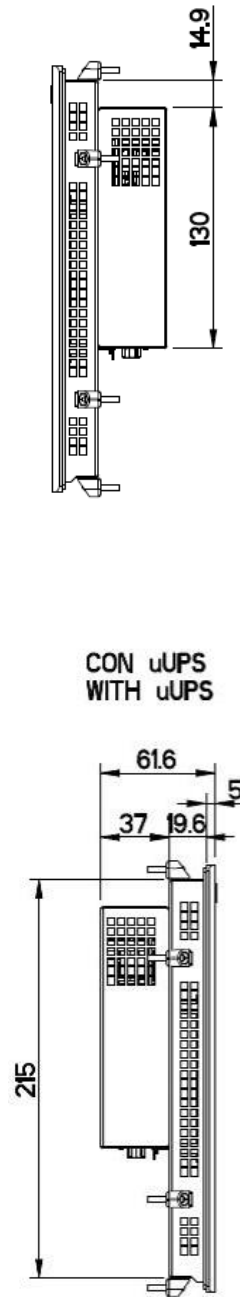

Figure 99
10.4"(resistive)

Figure 100
10.4" (resistive)



8.3.7 12.1" (resistive)

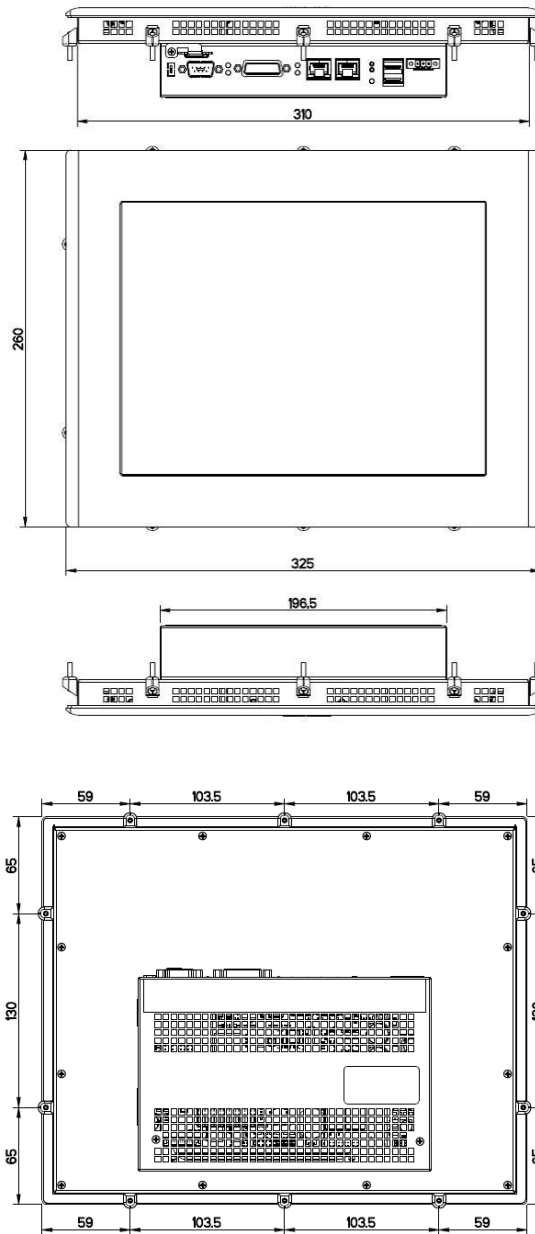
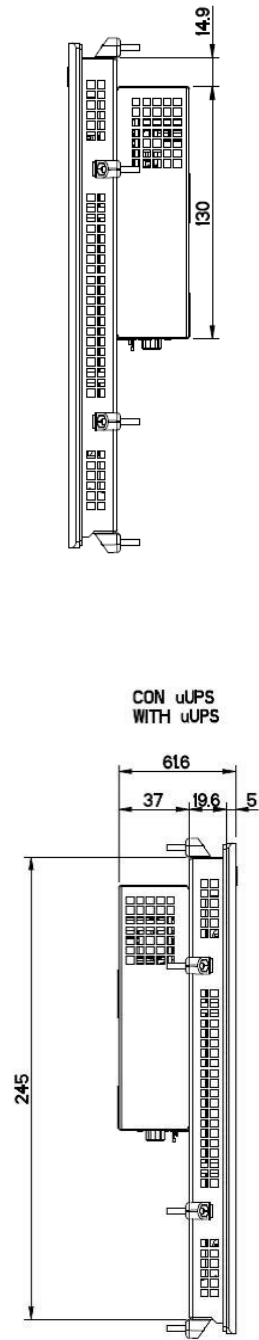

Figure 101
12.1" (resistive)

Figure 102
12.1" (resistive)



8.3.8 12.1" W (resistive)

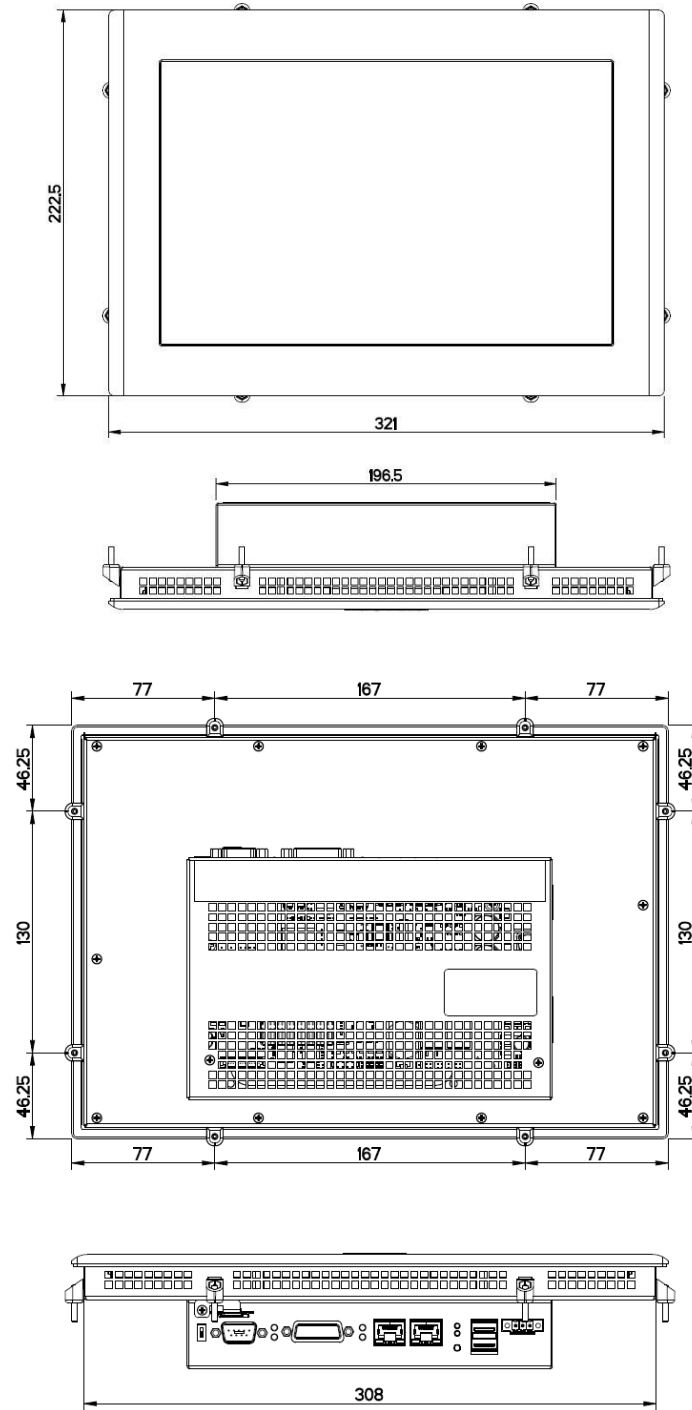
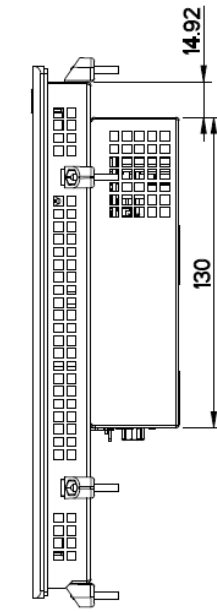
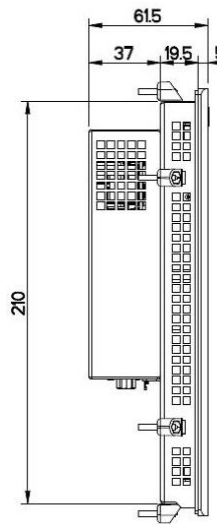

Figure 103
12.1" W (resistive)

Figure 104
12.1" W (resistive)



CON uUPS
WITH uUPS



8.3.9 12.1"W (capacitive)

Figure 105
12.1" W (capacitive)

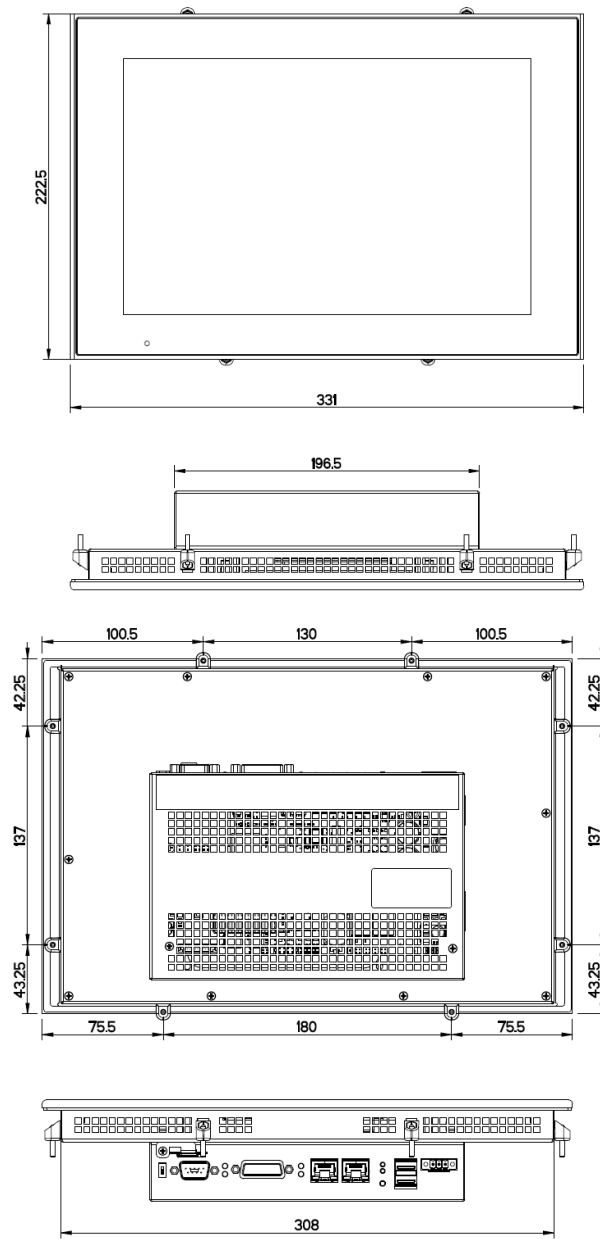
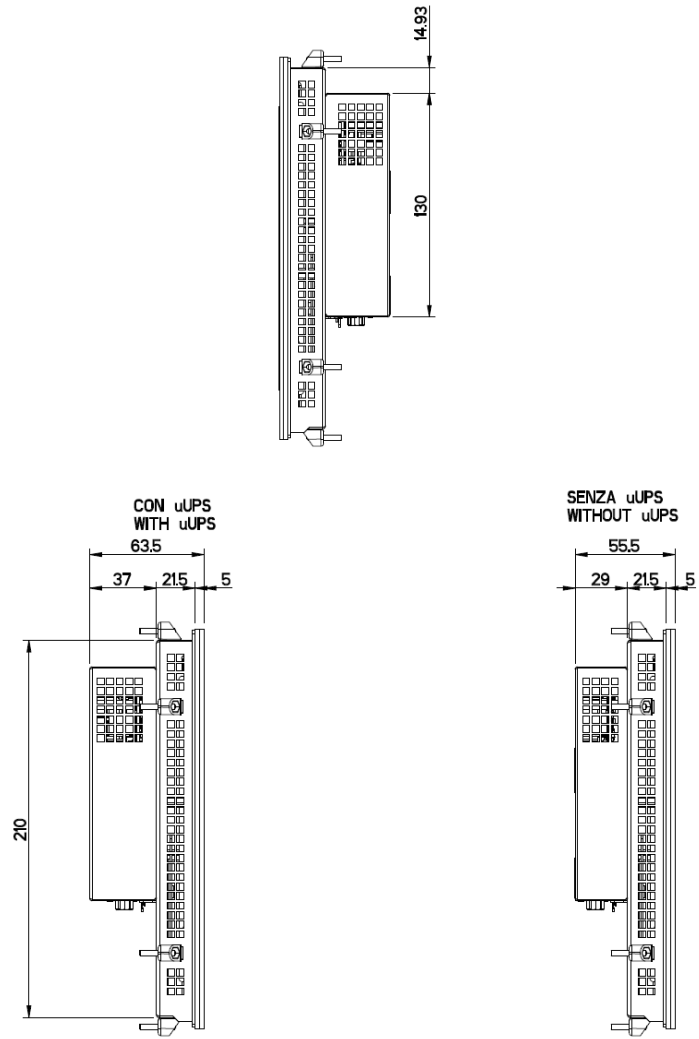

Figure 106
12.1" W (capacitive)



8.3.10 15.0" (resistive)

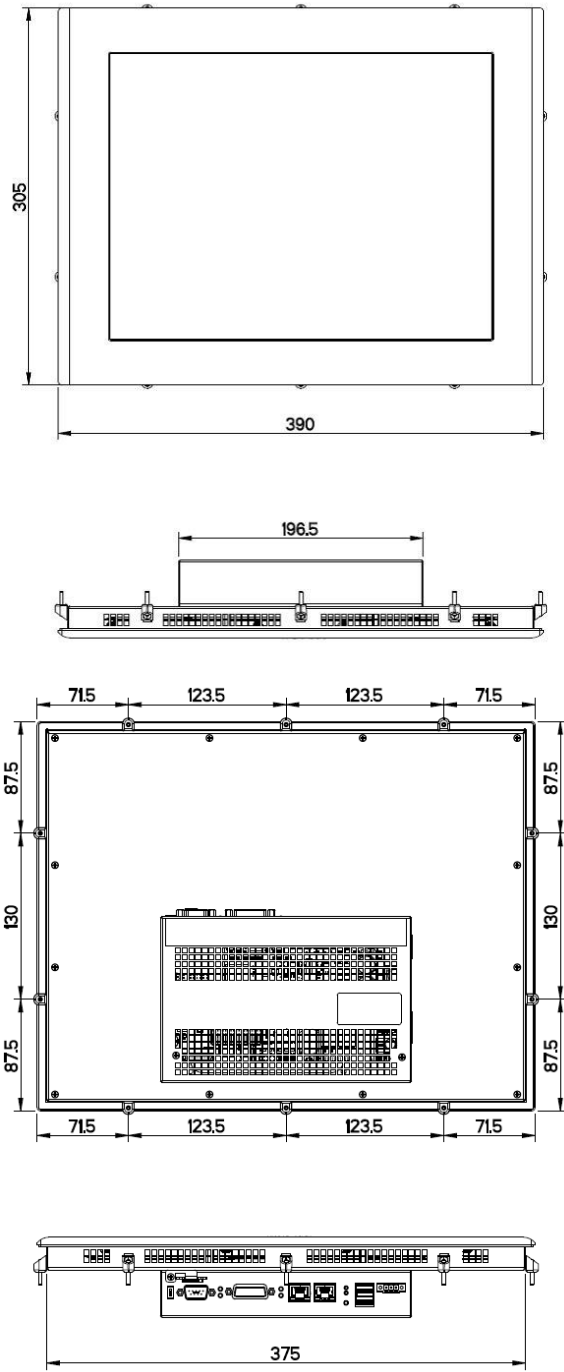
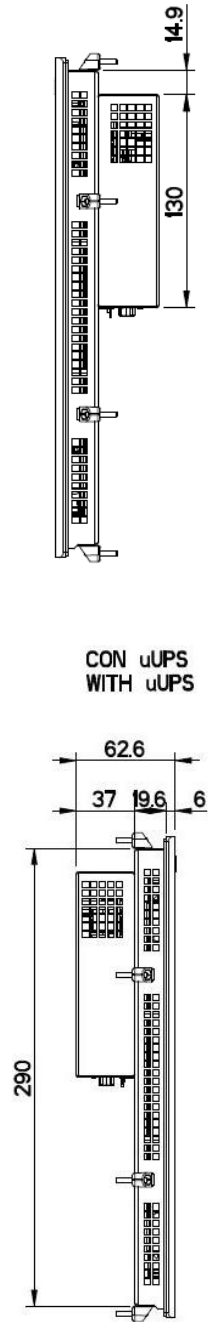

Figure 107
15.0" (resistive)

Figure 108
15.0" (resistive)



8.3.11 15.6" W (resistive)

Figure 109
15.6" W (resistive)

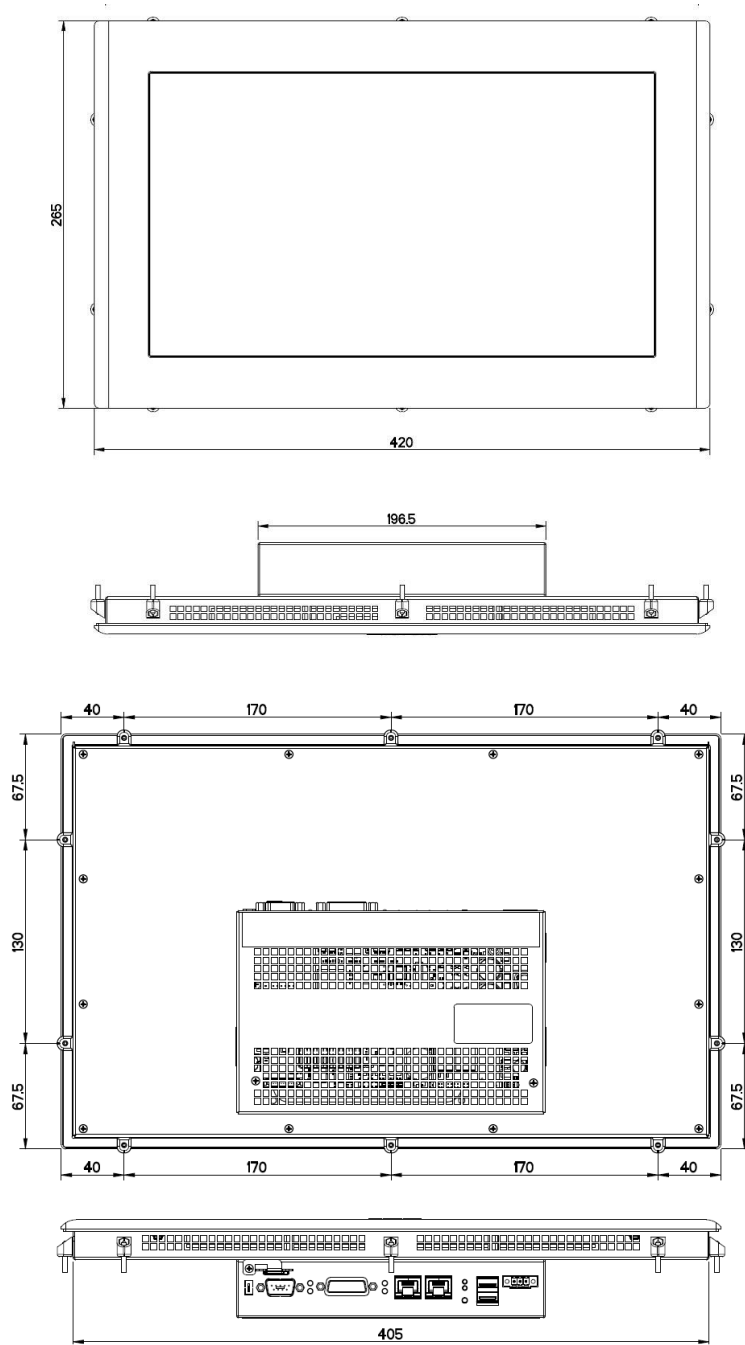
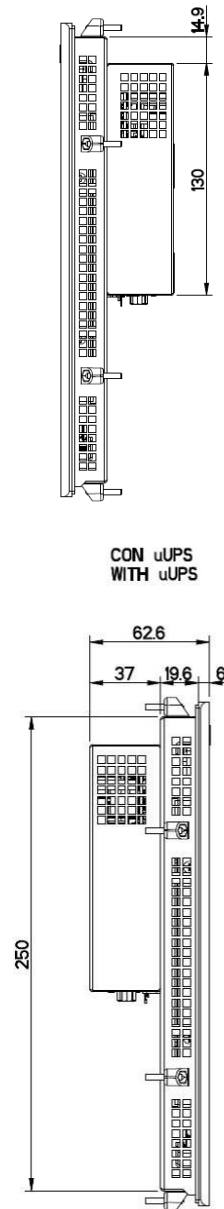

Figure 110
15.6" W (resistive)



8.3.12 15.6" W (capacitive)

Figure 111
15.6" W (capacitive)

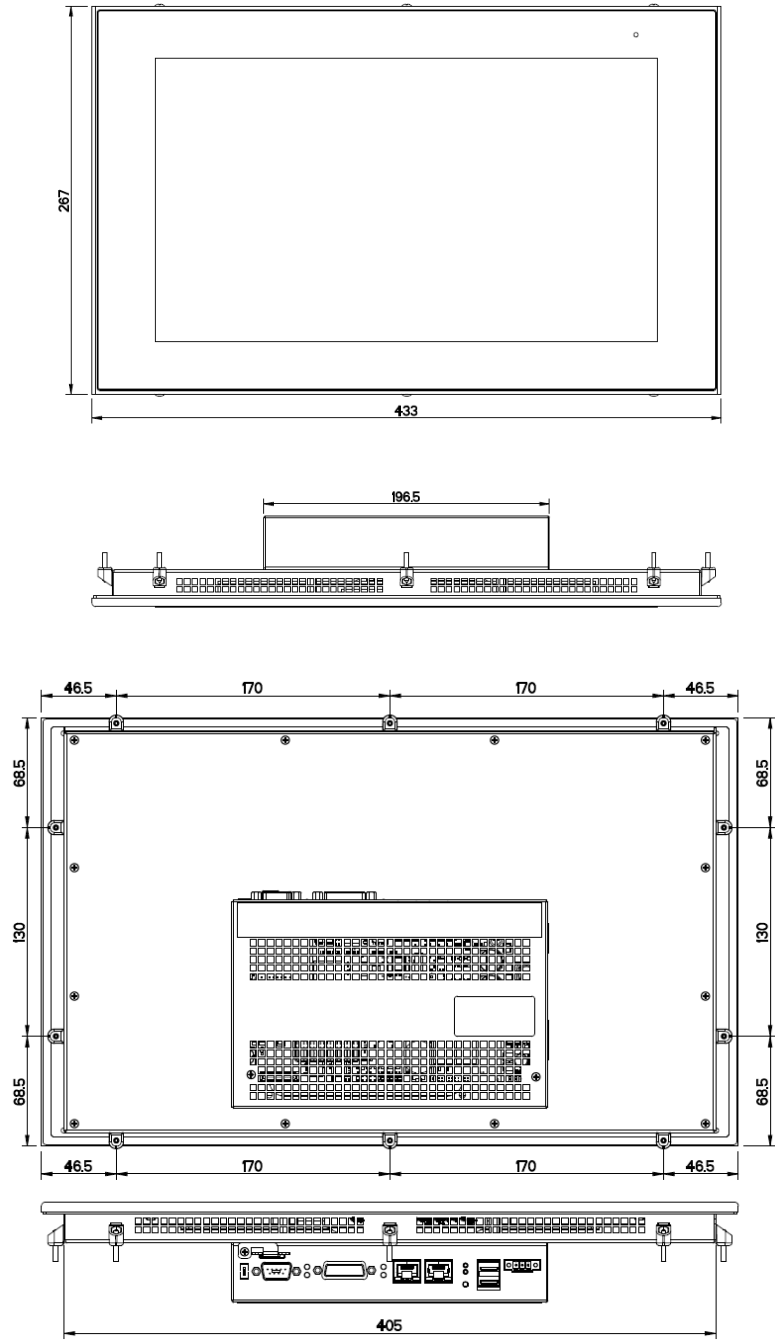
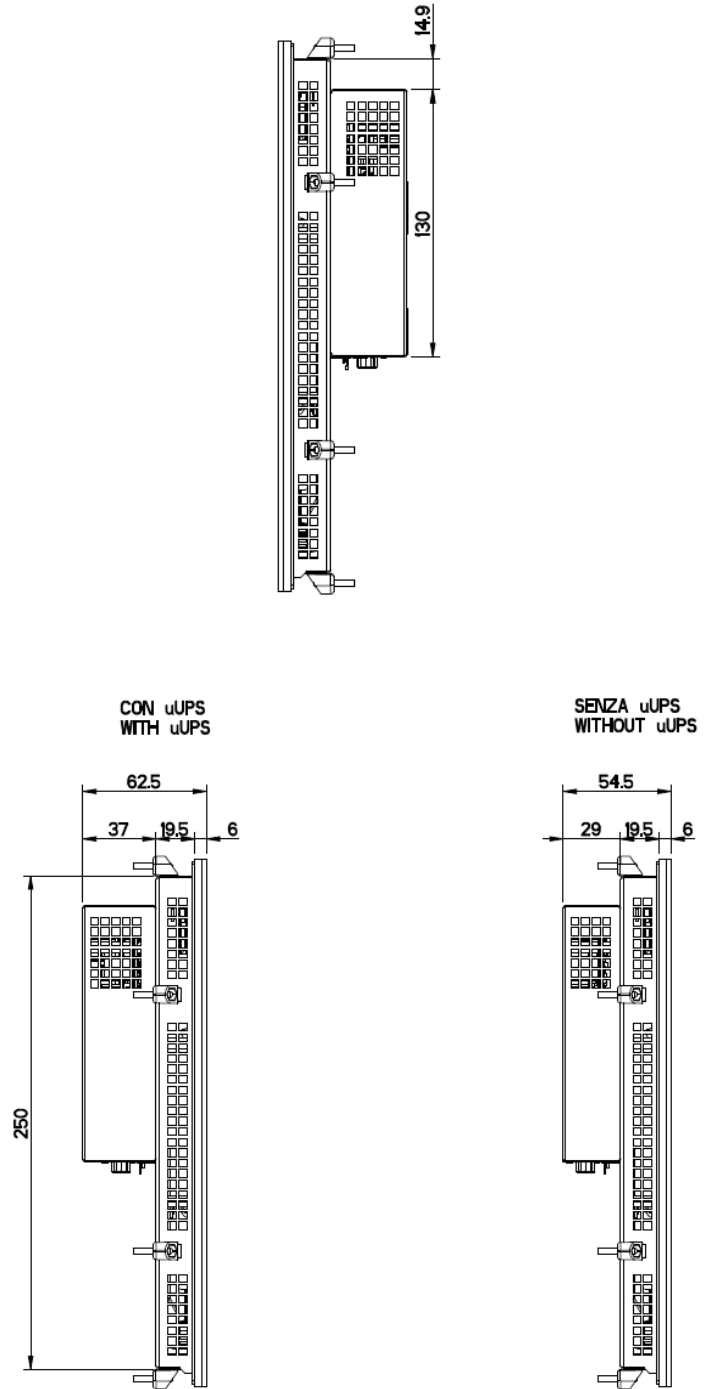

Figure 112
15.6" W (capacitive)



8.4 Ports PINOUT

8.4.1 COM1

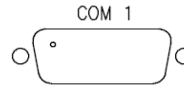

Table 21
COM1 – DB15M

PIN	Signal	I/O
1	+5 VDC	OUT
2	Transmit data (RS-232)	OUT
3	Receive data (RS-232)	IN
4	Request to send	OUT
5	Clear to send	IN
6	Data set ready	IN
7	Ground	—
8	Data terminal ready	OUT
9	Carrier detect	IN
10	Transmit data +/receive data + (RS-485/RS-422)	I/O
11	Transmit data -/receive data - (RS-485/RS-422)	I/O
12	Ring indication (RS-232)	IN
13	Receive data + (RS-422)	IN
14	Receive data - (RS-422)	IN
15	N.C.	N.C.

If necessary, a polarization or termination resistor of the RS422/485 channel must be wired in the connector by the user.

8.4.2 LAN1 – LAN2

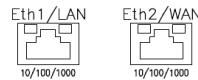

Table 22
LAN1 – LAN2

PIN	Signal
1	TX+
2	TX-
3	RX+
4	Shield
5	Shield
6	RX-
7	Shield
8	Shield

8.4.3 CAN



Table 23
CAN

PIN	Signal	I/O
1	N.C.	N.C.
2	CANL	IN/OUT
3	GND	—
4	N.C.	N.C.
5	Shield	—
6	GND	—
7	CANH	IN/OUT
8	N.C.	N.C.
9	+5 VDC	OUT

8.4.4 RS485

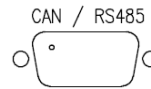

Table 24
RS485

<i>PIN</i>	<i>Signal</i>	<i>I/O</i>
1	N.C.	N.C.
2	N.C.	N.C.
3	TX+/RX+	I/O
4	N.C.	N.C.
5	GND	—
6	+5 VDC	OUT
7	N.C.	N.C.
8	TX-/RX-	I/O
9	N.C.	N.C.

8.4.5 USB1 / USB2

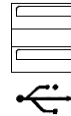

Table 25
USB1 – USB2

<i>PIN</i>	<i>Signal</i>
1	+5 Vcc
2	USB Data -
3	USB Data +
4	GND

8.5 Technical support & repairs

KEB offers wide-ranging, complete after-sales technical support.

You can phone our staff in the service department and they will give you skillfully advice on how to resolve your problems.

Email: combicontrol@KEB.de

8.6 Recycling and disposal

The system can be recycled due to the use of materials with low environmental impact. Contact a certified disposal service company for environmentally sound recycling and disposal of your old devices.

Figure 1 Full aluminium resistive front panel details	11
Figure 2 Capacitive front panel details	11
Figure 3 Full aluminium front panel detail (in the figure is shown as an example a 15.0" display).....	12
Figure 4 Front panel "Step" detail	12
Figure 5 Construction detail.....	13
Figure 6 Front Panel capacitive (the figure shows a 15.6" display as an example)	14
Figure 7 Front Panel capacitive "No Step" details	14
Figure 8 Construction details	15
Figure 9 C6 S14 rear view.....	16
Figure 10 C6 S14 side view.....	16
Figure 11 C6 S14 side view.....	16
Figure 12 C6 S14 connectors.....	17
Figure 13 System connectors label details.....	18
Figure 14 System label details	18
Figure 15 μ UPS details.....	19
Figure 16 Configuration and project creation.....	20
Figure 17 Process management.....	20
Figure 18 Mounting position.....	23
Figure 19 Installation distances	24
Figure 20 Cutout	25
Figure 21 Installation	27
Figure 22 Installation	27
Figure 23 Installation	28
Figure 24 Installation	28
Figure 25 Installation	28
Figure 26 Installation	29
Figure 27 Power supply connection details.....	30
Figure 28 Power supply connection details.....	31
Figure 29 Power supply connection details.....	31
Figure 30 Connecting the configuration PC	32
Figure 31 Connecting the configuration PC	33
Figure 32 Connecting the configuration PC	33
Figure 33 Connecting the configuration PC	34
Figure 34 Connecting the configuration PC	34
Figure 35 Commissioning the device.....	36
Figure 36 Slot for memory card	37
Figure 37 Slot for memory card	37
Figure 38 Slot for memory card	37
Figure 39 Slot for memory card	38
Figure 40 Slot for memory card	38
Figure 41 Slot for memory card	38
Figure 42 Opening Control Panel	41
Figure 43 Starting the configuration for the serial port.....	41
Figure 44 Configuration for the serial port	42
Figure 45 Serial Port configuration saved.....	42
Figure 46 Stopping the running project	44
Figure 47 Stopping the running project	44
Figure 48 Starting the project	45
Figure 49 Starting the project	45
Figure 50 Debug the project	46
Figure 51 Debug the project	47
Figure 52 Debug the project	47
Figure 53 Debug the project	47
Figure 54 Debug the project	48
Figure 55 Debug the project	49
Figure 56 Task configuration	50
Figure 57 Setting the active path.....	51
Figure 58 Start CDlauch-Mgr.exe.....	53

Figure 59 CDS Launch Manager.....	55
Figure 60 Configuring COMBIVIS studio 6 project	56
Figure 61 Device name in COMBIVIS studio 6.....	56
Figure 62 CONTROL implementation	57
Figure 63 COMBIVIS connect implementation.....	58
Figure 64 COMBIVIS connect implementation.....	58
Figure 65 COMBIVIS connect implementation.....	58
Figure 66 COMBIVIS connect implementation.....	58
Figure 67 System Manager Control Panel Applets	61
Figure 68 Backup Restore	62
Figure 69 Font Antialiasing	66
Figure 70 EMMC Usage	66
Figure 71 Kiosk Mode.....	67
Figure 72 Launch Explorer from COMBIVIS studio HMI	68
Figure 73 Language Settings.....	68
Figure 74 Configuring Scrollbar	69
Figure 75 System Reboot	69
Figure 76 Calibration of the touchscreen.....	71
Figure 77 Calibration of the touchscreen.....	71
Figure 78 Calibration of the touchscreen.....	72
Figure 79 Backup battery replacement.....	73
Figure 80 Backup battery replacement.....	73
Figure 81 Backup battery replacement.....	74
Figure 82 Backup battery replacement.....	74
Figure 83 Backup battery replacement.....	75
Figure 84 Backup battery detail.....	75
Figure 85 Backup battery replacement.....	76
Figure 86 Backup battery replacement.....	76
Figure 87 Backup battery replacement.....	77
Figure 88 Backup battery replacement.....	77
Figure 89 7.0" W (resistive).....	91
Figure 90 7.0" W (resistive).....	92
Figure 91 7.0" W (capacitive) CUTOUT B	93
Figure 92 7.0" W capacitive CUT OUT B	94
Figure 93 8.4" (resistive).....	95
Figure 94 8.4" (resistive).....	96
Figure 95 10.1" W (resistive).....	97
Figure 96 10.1" W (resistive).....	98
Figure 97 10.1" W (capacitive)	99
Figure 98 10.1" W (capacitive)	100
Figure 99 10.4"(resistive).....	101
Figure 100 10.4" (resistive).....	102
Figure 101 12.1" (resistive).....	103
Figure 102 12.1" (resistive).....	104
Figure 103 12.1" W (resistive).....	105
Figure 104 12.1" W (resistive).....	106
Figure 105 12.1" W (capacitive)	107
Figure 106 12.1" W (capacitive)	108
Figure 107 15.0" (resistive).....	109
Figure 108 15.0" (resistive).....	110
Figure 109 15.6" W (resistive).....	111
Figure 110 15.6" W (resistive).....	112
Figure 111 15.6" W (capacitive)	113
Figure 112 15.6" W (capacitive)	114

Austria | KEB Automation GmbH
Ritzstraße 8 4614 Marchtrenk Austria
Tel: +43 7243 53586-0 Fax: +43 7243 53586-21
E-Mail: info@keb.at Internet: www.keb.at

Benelux | KEB Automation KG
Dreef 4 - box 4 1703 Dilbeek Belgium
Tel: +32 2 447 8580
E-Mail: info.benelux@keb.de Internet: www.keb.de

Brazil | KEB South America - Regional Manager
Rua Dr. Omar Pacheco Souza Riberio, 70
CEP 13569-430 Portal do Sol, São Carlos Brazil
Tel: +55 16 31161294 E-Mail: roberto.arias@keb.de

Czech Republic | KEB Automation GmbH
Videnska 188/119d 61900 Brno Czech Republic
Tel: +420 544 212 008
E-Mail: info@keb.cz Internet: www.keb.cz

France | Société Française KEB SASU
Z.I. de la Croix St. Nicolas 14, rue Gustave Eiffel
94510 La Queue en Brie France
Tel: +33 149620101 Fax: +33 145767495
E-Mail: info@keb.fr Internet: www.keb.fr

Germany | Geared Motors
KEB Antriebstechnik GmbH
Wildbacher Straße 5 08289 Schneeberg Germany
Telefon +49 3772 67-0 Telefax +49 3772 67-281
Internet: www.keb-drive.de E-Mail: info@keb-drive.de

Italy | KEB Italia S.r.l. Unipersonale
Via Newton, 2 20019 Settimo Milanese (Milano) Italia
Tel: +39 02 3353531 Fax: +39 02 33500790
E-Mail: info@keb.it Internet: www.keb.it

Japan | KEB Japan Ltd.
15 - 16, 2 - Chome, Takanawa Minato-ku Tokyo 108 - 0074 Japan
Tel: +81 33 445-8515 Fax: +81 33 445-8215
E-Mail: info@keb.jp Internet: www.keb.jp

P. R. China | KEB Power Transmission Technology (Shanghai) Co. Ltd.
No. 435 QianPu Road Chedun Town Songjiang District
201611 Shanghai P.R. China
Tel: +86 21 37746688 Fax: +86 21 37746600
E-Mail: info@keb.cn Internet: www.keb.cn

Poland | KEB Automation KG
Tel: +48 60407727
E-Mail: roman.trinczek@keb.de Internet: www.keb.de

Republic of Korea | KEB Automation KG
Deoksan-Besttel 1132 ho Sangnam-ro 37
Seongsan-gu Changwon-si Gyeongsangnam-do Republic of Korea
Tel: +82 55 601 5505 Fax: +82 55 601 5506
E-Mail: jaeok.kim@keb.de Internet: www.keb.de

Russian Federation | KEB RUS Ltd.
Lesnaya str, house 30 Dzerzhinsky MO
140091 Moscow region Russian Federation
Tel: +7 495 6320217 Fax: +7 495 6320217
E-Mail: info@keb.ru Internet: www.keb.ru

Spain | KEB Automation KG
c / Mitjer, Nave 8 - Pol. Ind. LA MASIA
08798 Sant Cugat Sesgarrigues (Barcelona) Spain
Tel: +34 93 8970268 Fax: +34 93 8992035 E-Mail: vb.espana@keb.de

Switzerland | KEB Automation AG
Witzbergstrasse 24 8330 Pfaeffikon/ZH Switzerland
Tel: +41 43 2886060 Fax: +41 43 2886088
E-Mail: info@keb.ch Internet: www.keb.ch

United Kingdom | KEB (UK) Ltd.
5 Morris Close Park Farm Industrial Estate
Wellingborough, Northants, NN8 6 XF United Kingdom
Tel: +44 1933 402220 Fax: +44 1933 400724
E-Mail: info@keb.co.uk Internet: www.keb.co.uk

United States | KEB America, Inc
5100 Valley Industrial Blvd. South
Shakopee, MN 55379 United States
Tel: +1 952 2241400 Fax: +1 952 2241499
E-Mail: info@kebameric.com Internet: www.kebameric.com



MORE KEB PARTNERS WORLDWIDE:

... www.keb.co.uk/contact/contact-worldwide



Automation with Drive

www.keb.de

KEB Automation KG Suedstrasse 38 32683 Barntrup Tel. +49 5263 401-0 E-Mail: info@keb.de