



# COMBIVERT G6

INSTRUCTIONS FOR USE | INSTALLATION G6 HOUSING A

Translation of the original manual  
Document 20086425 EN 07






# Preface

The hardware and software described in this document are products of KEB. The information contained in this document is valid at the time of publishing. KEB reserves the right to update this document in response to misprints, mistakes or technical changes.

## Signal words and symbols

Certain procedures within this document can cause safety hazards during the installation or operation of the device. Refer to the safety warnings in this document when performing these procedures. Safety signs are also located on the device where applicable. A safety warning is marked by one of the following warning signs:

 <b>DANGER</b>	Dangerous situation, which will cause death or serious injury if this safety warning is ignored.
 <b>WARNING</b>	Dangerous situation, which may cause death or serious injury if this safety warning is ignored.
 <b>CAUTION</b>	Dangerous situation, which may cause minor injury if this safety warning is ignored.
<b>NOTICE</b>	Situation, which can cause damage to property if this safety warning is ignored.

### RESTRICTION

Used when the following statements depend on certain conditions or are only valid for certain ranges of values.



Used for informational messages or recommended procedures.

## More symbols

- ▶ This arrow starts an action step.
- / - Enumerations are marked with dots or indents.
- => Cross reference to another chapter or another page.



Note to further documentation.  
[www.keb.de/service/downloads](http://www.keb.de/service/downloads)



## Laws and guidelines

KEB Automation KG confirms with the EC declaration of conformity and the CE mark on the device nameplate that it complies with the essential safety requirements.

The EC declaration of conformity can be downloaded on demand via our website.

## Warranty and liability

The warranty and liability on design, material or workmanship for the acquired device is given in the general sales conditions.



Here you will find our general sales conditions.  
[www.keb.de/terms-and-conditions](http://www.keb.de/terms-and-conditions)



Further agreements or specifications require a written confirmation.

## Support

Although multiple applications are referenced, not every case has been taking into account. If you require further information or if problems occur which are not referenced in the documentation, you can request the necessary information via the local KEB agency.

**The use of our units in the target products is outside of our control and therefore lies exclusively in the area of responsibility of the customer.**

The information contained in the technical documentation, as well as any user-specific advice in spoken and written and through tests, are made to best of our knowledge and information about the intended use. However, they are regarded as being only informal and changes are expressly reserved, in particular due to technical changes. This also applies to any violation of industrial property rights of a third-party. Selection of our units in view of their suitability for the intended use must be done generally by the user.

**Tests can only be done within the intended end use of the product (application) by the customer. They must be repeated, even if only parts of hardware, software or the unit adjustment are modified.**

## Copyright

The customer may use the instructions for use as well as further documents or parts from it for internal purposes. Copyrights are with KEB and remain valid in its entirety.

This KEB product or parts thereof may contain third-party software, including free and/or open source software. If applicable, the license terms of this software are contained in the instructions for use. The instructions for use are already available to you, can be downloaded free of charge from the KEB website or can be requested from the respective KEB contact person.

Other wordmarks or/and logos are trademarks (™) or registered trademarks (®) of their respective owners.

# Table of Contents

<b>Preface</b> .....	<b>3</b>
Signal words and symbols .....	3
More symbols.....	3
Laws and guidelines.....	4
Warranty and liability.....	4
Support .....	4
Copyright.....	4
<b>Table of Contents</b> .....	<b>5</b>
<b>List of Figures</b> .....	<b>8</b>
<b>List of Tables</b> .....	<b>9</b>
<b>Glossary</b> .....	<b>10</b>
<b>Standards for drive converters/control cabinets</b> .....	<b>12</b>
Product standards that apply directly to the drive converter .....	12
Basic standards to which drive converter standards refer directly .....	12
Standards that are used in the environment of the drive converter .....	13
<b>1 Basic Safety Instructions</b> .....	<b>14</b>
<b>1.1 Target group</b> .....	<b>14</b>
<b>1.2 Transport, storage and proper use</b> .....	<b>14</b>
<b>1.3 Installation</b> .....	<b>15</b>
<b>1.4 Electrical connection</b> .....	<b>16</b>
1.4.1 EMC-compatible installation.....	17
1.4.2 Voltage test.....	17
1.4.3 Insulation measurement.....	17
<b>1.5 Start-up and operation</b> .....	<b>18</b>
<b>1.6 Maintenance</b> .....	<b>19</b>
<b>1.7 Repair</b> .....	<b>20</b>
<b>1.8 Disposal</b> .....	<b>20</b>
<b>2 Product Description</b> .....	<b>21</b>
<b>2.1 Specified application</b> .....	<b>21</b>
2.1.1 Residual risks .....	21
<b>2.2 Unintended use</b> .....	<b>21</b>
<b>2.3 Product features</b> .....	<b>22</b>
<b>2.4 Part code</b> .....	<b>23</b>
<b>3 Technical Data</b> .....	<b>25</b>
<b>3.1 Operating conditions</b> .....	<b>25</b>
3.1.1 Climatic ambient conditions.....	25
3.1.2 Mechanical ambient conditions .....	26
3.1.3 Chemical / mechanical active substances.....	26
3.1.4 Electrical operating conditions.....	27

3.1.4.1 Device classification .....	27
3.1.4.2 Electromagnetic compatibility .....	27
<b>3.2 Technical data G6 230V devices .....</b>	<b>28</b>
<b>3.3 Technical data G6 400V devices .....</b>	<b>29</b>
3.3.1 Overload and derating .....	30
<b>3.4 Dimensions and weights .....</b>	<b>32</b>
3.4.1 Control cabinet installation .....	33
3.4.1.1 Ventilation in the control cabinet.....	33

## **4 Installation and Connection..... 34**

<b>4.1 Overview of the COMBIVERT G6 .....</b>	<b>34</b>
<b>4.2 Connection of the power unit.....</b>	<b>35</b>
4.2.1 Connection of the voltage supply .....	35
4.2.1.1 Wiring instructions .....	35
4.2.1.2 Line terminal strip X1A .....	36
4.2.2 Leakage currents.....	36
4.2.3 AC connection .....	37
4.2.3.1 AC supply 230V / 1-phase.....	37
4.2.3.2 AC supply 400V / 3-phase.....	37
4.2.3.3 Cross-section of the supply cable .....	38
4.2.4 Connection at DC voltage supply .....	38
4.2.4.1 Terminal block X1B DC connection .....	38
4.2.5 Connection of the motor .....	38
4.2.5.1 Selection of the motor cable.....	38
4.2.5.2 Cable-fed disturbances depending on the motor cable length at AC supply.....	39
4.2.5.3 Motor cable length at operation with DC voltage.....	39
4.2.5.4 Motor cable length for parallel operation of motors .....	39
4.2.5.5 Motor cable cross-section .....	39
4.2.5.6 Interconnection of the motor.....	40
4.2.5.7 Terminal block X1B motor connection .....	40
4.2.5.8 Wiring of the motor .....	40
4.2.6 Connection of a braking resistor.....	41
4.2.6.1 Terminal block X1B connection braking resistor.....	41
4.2.6.2 Wiring of an intrinsically safe braking resistor .....	42
4.2.6.3 Use of non-intrinsically safe braking resistors .....	42
4.2.7 Connection of a temperature detection .....	43
4.2.7.1 Temperature detection terminals T1, T2.....	43
4.2.7.2 Terminal block X1C temperature detection .....	43
4.2.7.3 Use of the temperature detection .....	44
4.2.8 Final test information .....	44
<b>4.3 Calculation of the motor voltage.....</b>	<b>44</b>

<b>5 UL certification.....</b>	<b>45</b>
5.1 CE-Marking.....	45
5.2 Functional safety .....	45
5.3 UL Marking .....	45
5.4 Further informations and documentation .....	48
<b>6 Accessories.....</b>	<b>49</b>
6.1 Mounting kit shield connection braket.....	49
<b>7 Revision History .....</b>	<b>50</b>

## List of Figures

Figure 1:	Maximum load and derating depending on the switching frequency .....	30
Figure 2:	Overload characteristic .....	31
Figure 3:	Dimensions and weights for G6 housing A .....	32
Figure 4:	Mounting distances .....	33
Figure 5:	Control cabinet ventilation.....	33
Figure 6:	Overview of the COMBIVERT G6.....	34
Figure 7:	Input circuit/ drive controllertype .....	35
Figure 8:	Line terminal strip X1A.....	36
Figure 9:	Connection of the mains supply 230 V / 1-phase .....	37
Figure 10:	Connection of the mains supply 400 V / 3-phase .....	37
Figure 11:	Connection at DC voltage supply.....	38
Figure 12:	Terminal block X1B DC connection.....	38
Figure 13:	Terminal block X1B motor connection.....	40
Figure 14:	Wiring of the motor.....	40
Figure 15:	Terminal block X1B connection of a braking resistor .....	41
Figure 16:	Wiring of an intrinsically safe braking resistor .....	42
Figure 17:	Temperature detection terminals T1, T2 .....	43
Figure 18:	Terminal block X1C temperature detection.....	43
Figure 19:	Wiring examples of the temperature input .....	44
Figure 20:	G6 housing A with optional mounting kit .....	49



## List of Tables

Table 1:	Part code.....	23
Table 2:	Climatic ambient conditions .....	25
Table 3:	Mechanical ambient conditions.....	26
Table 4:	Chemical / mechanical active substances .....	26
Table 5:	Device classification.....	27
Table 6:	Electromagnetic compatibility .....	27
Table 7:	Technical data 230V devices .....	28
Table 8:	Technical data 400V devices .....	29
Table 9:	Leakage current 1-phase .....	36
Table 10:	Leakage currents 3-phase .....	36
Table 11:	Cable-fed disturbances depending on the motor cable length at AC supply .....	39
Table 12:	Motor cable length at operation with DC voltage .....	39
Table 13:	Calculation of the motor voltage .....	44
Table 14:	Mounting kit shield connection bracket for G6 housing A.....	49

## Glossary

0V	Earth-potential-free common point	Endat	Bidirectional encoder interface of the company Heidenhain
1ph	1-phase mains	EtherCAT	Real-time Ethernet bus system of the company Beckhoff
3ph	3-phase mains	Ethernet	Real-time bus system - defines protocols, plugs, types of cables
AC	AC current or voltage	FE	Functional earth
AFE	From 07/2019 AIC replaces the previous name AFE	FSoE	Functional Safety over Ethernet
AFE filter	From 07/2019 AIC filter replaces the previous name AFE filter	FU	Drive controller
AIC	Active Infeed Converter	GND	Reference potential, ground
AIC filter	Filter for Active Infeed Converter	GTR7	Braking transistor
Application	The application is the intended use of the KEB product	HF filter	High frequency filter to the mains
ASCL	Asynchronous sensorless closed loop	Hiperface	Bidirectional encoder interface of the company Sick-Stegmann
Auto motor ident.	Automatically motor identification; calibration of resistance and inductance	HMI	Human machine interface (touch screen)
AWG	American wire gauge	HSP5	Fast, serial protocol
B2B	Business-to-business	HTL	Incremental signal with an output voltage (up to 30V) -> TTL
BiSS	Open source real-time interface for sensors and actuators (DIN 5008)	IEC	International standard
CAN	Fieldbus system	IP xx	Degree of protection (xx for level)
CDF	Cyclic duration factor	KEB product	The KEB product is subject of this manual
CDM	Complete drive module including auxiliary equipment (control cabinet)	KTY	Silicium temperature sensor (polarized)
COMBIVERT	KEB drive controller	Manufacturer	The manufacturer is KEB, unless otherwise specified (e.g. as manufacturer of machines, engines, vehicles or adhesives)
COMBIVIS	KEB start-up and parameterizing software	MCM	American unit for large wire cross sections
Customer	The customer has purchased a KEB product from KEB and integrates the KEB product into his product (customer product) or resells the KEB product (dealer)	Modulation	Means in drive technology that the power semiconductors are controlled
DC	DC current or voltage	MTTF	Mean service life to failure
DI	Demineralized water, also referred to as deionized (DI) water	NN	Sea level
DIN	German Institut for standardization	OC	Overcurrent
DS 402	CiA DS 402 - CAN device profile for drives	OH	Overheat
EMC	Electromagnetic compatibility	OL	Overload
Emergency stop	Shutdown of a drive in emergency case (not de-energized)	OSSD	Output signal swithching device; - an output signal that is checked in regular intervals on its shutdown. (safety technology)
Emergency switching off	Switching off the voltage supply in emergency case	PDS	Power drive system incl. motor and measuring probe
EMS	Energy Management System	PE	Protective earth
EN	European standard	PELV	Protective Extra Low Voltage
Encoder emulation	Software-generated encoder output	PFD	Term used in the safety technology (EN 61508-1...7) for the size of error probability
End customer	The end customer is the user of the customer product		

PFH	Term used in the safety technology (EN 61508-1...7) for the size of error probability per hour
PLC	Programmable logic controller
Pt100	Temperature sensor with $R_0=100\Omega$
Pt1000	Temperature sensor with $R_0=1000\Omega$
PTC	PTC-resistor for temperature detection
PWM	Pulse width modulation
RJ45	Modular connector with 8 lines
SCL	Synchronous sensorless closed loop
SELV	Safety Extra Low Voltage (<60 V)
SIL	The safety integrity level is a measure for quantifying the risk reduction. Term used in the safety technology (EN 61508 -1...7)
SS1	Safety function „Safe stop 1“ in accordance with IEC 61800-5-2
SSI	Synchronous serial interface for encoder
STO	Safety function „Safe Torque Off“ in accordance with IEC 61800-5-2
TTL	Incremental signal with an output voltage up to 5V
USB	Universal serial bus
VARAN	Real-time Ethernet bus system

## Standards for drive controllers

### Product standards that apply directly to the drive controller

EN61800-2	Adjustable speed electrical power drive systems - Part 2: General requirements - Rating specifications for low voltage adjustable frequency a.c. power drive systems (VDE 0160-102, IEC 61800-2)
EN61800-3	Speed-adjustable electrical drives. Part 3: EMC requirements and specific test methods (VDE 0160-103, IEC 61800-3)
EN61800-5-1	Adjustable speed electrical power drive systems - Part 5-1: Safety requirements - Electrical, thermal and energy (IEC 61800-5-1); German version EN 61800-5-1
EN61800-5-2	Adjustable speed electrical power drive systems - Part 5-2: Safety Requirements - Functional (IEC 22G/264/CD)
UL61800-5-1	American version of the EN61800-5-1 with „National Deviations“

### Basic standards to which drive controller standards refer directly

EN 55011	Industrial, scientific and medical equipment - Radio frequency disturbance characteristics - Limits and methods of measurement (CISPR 11); German version EN 55011
EN 55021	Interference to mobile radiocommunications in the presence of impulse noise - Methods of judging degradation and measures to improve performance (IEC/ CISPR/D/230/FDIS); German version prEN 55021
EN 60529	Degrees of protection provided by enclosures (IP Code) (IEC 60529)
EN 60664-1	Insulation coordination for equipment within low-voltage systems Part 1: Principles, requirements and tests (IEC 60664-1)
EN 60721-3-1	Classification of environmental conditions - Part 3-1: Classification of groups of environmental parameters and their severities - Section 1: Storage (IEC 60721-3-1); German version EN 60721-3-1
EN 60721-3-2	Classification of environmental conditions - Part 3: Classification of groups of environmental parameters and their severities - Section 2: Transportation and handling (IEC 104/670/CD)
EN 60721-3-3	Classification of environmental conditions - Part 3: Classification of groups of environmental parameters and their severities; section 3: Stationary use at weatherprotected locations; Amendment A2 (IEC 60721-3-3); German version EN 60721-3-3
EN 61000-2-1	Electromagnetic compatibility (EMC) - Part 2: Environment - Section 1: Description of the environment - Electromagnetic environment for low-frequency conducted disturbances and signalling in public power supply systems
EN 61000-2-4	Electromagnetic compatibility (EMC) - Part 2-4: Environment; Compatibility levels in industrial plants for low-frequency conducted disturbances (IEC 61000-2-4); German version EN 61000-2-4
EN 61000-4-2	Electromagnetic compatibility (EMC) - Part 4-2: Testing and measurement techniques - Electrostatic discharge immunity test (IEC 61000-4-2); German version EN 61000-4-2
EN 61000-4-3	Electromagnetic compatibility (EMC) - Part 4-3: Testing and measurement techniques - Radiated, radio-frequency, electromagnetic field immunity test (IEC 61000-4-3); German version EN 61000-4-3
EN 61000-4-4	Electromagnetic compatibility (EMC) - Part 4-4: Testing and measurement techniques - Electrical fast transient/burst immunity test (IEC 61000-4-4); German version EN 61000-4-4

EN61000-4-5	Electromagnetic compatibility (EMC) - Part 4-5: Testing and measurement techniques - Surge immunity test (IEC 61000-4-5); German version EN 61000-4-5
EN61000-4-6	Electromagnetic compatibility (EMC) - Part 4-6: Testing and measurement techniques - Immunity to conducted disturbances, induced by radio-frequency fields (IEC 61000-4-6); German version EN 61000-4-6
EN61000-4-34	Electromagnetic compatibility (EMC) - Part 4-34: Testing and measurement techniques - Voltage dips, short interruptions and voltage variations immunity tests for equipment with mains current more than 16 A per phase (IEC 61000-4-34); German version EN 61000-4-34
EN61508-1...7	Functional safety of electrical/electronic/programmable electronic safety-related systems – Part 1...7 (VDE 0803-1...7, IEC 61508-1...7)
EN62061	Safety of machinery - functional safety of electrical, electronic and programmable electronic safety-related systems (VDE 0113-50, IEC 62061)
EN ISO 13849-1	Safety of machinery - safety-related parts of control systems - Part 1: General principles for design (ISO 13849-1); German version EN ISO 13849-1

### Standards that are used in the environment of the drive controller

DGUV regulation 3	Electrical installations and equipment
DIN IEC 60364-5-54	Low-voltage electrical installations - Part 5-54: Selection and erection of electrical equipment - Earthing arrangements, protective conductors and protective bonding conductors (IEC 64/1610/CD)
DIN VDE 0100-729	Low-voltage electrical installations - Part 7-729: Requirements for special installations or locations - Operating or maintenance gangways (IEC 60364-7-729:2007, modified); German implementation HD 60364-7-729:2009
DNVGL-CG-0339	Environmental test specification for electrical, electronic and programmable equipment and systems
EN 1037	Safety of machinery - Prevention of unexpected start-up; German version EN 1037
EN 12502-1...5	Protection of metallic materials against corrosion - Part 1...5
EN 60204-1	Safety of machinery - electrical equipment of machines Part 1: General requirements (VDE 0113-1, IEC 44/709/CDV)
EN 60439-1	Low-voltage switchgear and controlgear assemblies - Part 1: Type-tested and partially type-tested assemblies (IEC 60439-1); German version EN 60439-1
EN 60947-7-1	Low-voltage switchgear and controlgear - Part 7-1: Ancillary equipment - Terminal blocks for copper conductors (IEC 60947-7-1:2009); German version EN 60947-7-1:2009
EN 60947-8	Low-voltage switchgear and controlgear - Part 8: Control units for built-in thermal protection (PTC) for rotating electrical machines (IEC 60947-8:2003 + A1:2006 + A2:2011)
EN 61373	Railway applications - Rolling stock equipment - Shock and vibration tests (IEC 61373); German version EN 61373
EN 61439-1	Low-voltage switchgear and controlgear assemblies - Part 1: General rules (IEC 121B/40/CDV); German version FprEN 61439-1
VGB R 455 P	Water treatment and use of materials in cooling systems
DIN EN 60939-1	Passive filter units for electromagnetic interference suppression - Part 1: Generic specification (IEC 60939-1:2010); German version EN 60939-1:2010

# 1 Basic Safety Instructions

The COMBIVERT is designed and constructed in accordance with state-of-the-art technology and the recognized safety rules and regulations. However, the use of such devices may cause functional hazards for life and limb of the user or third parties, or damages to the system and other material property.

The following safety instructions have been created by the manufacturer for the area of electric drive technology. They can be supplemented by local, country- or application-specific safety instructions. This list is not exhaustive. Violation of the safety instructions by the customer, user or other third party leads to the loss of all resulting claims against the manufacturer.

## NOTICE



### Hazards and risks through ignorance.

- ▶ Read the instructions for use !
- ▶ Observe the safety and warning instructions !
- ▶ If anything is unclear, please contact KEB Automation KG !

## 1.1 Target group

This instruction manual is determined exclusively for electrical personnel. Electrical personnel for the purpose of this instruction manual must have the following qualifications:

- Knowledge and understanding of the safety instructions.
- Skills for installation and assembly.
- Start-up and operation of the product.
- Understanding of the function in the used machine.
- Detection of hazards and risks of the electrical drive technology.
- Knowledge of *DIN IEC 60364-5-54*.
- Knowledge of national safety regulations.

## 1.2 Transport, storage and proper use

The transport is carried out by qualified persons in accordance with the environmental conditions specified in this manual. Drive controller shall be protected against excessive strains.



### Transport of drive controllers with an edge length >75 cm

The transport by forklift without suitable tools can cause a deflection of the heat sink. This leads to premature aging or destruction of internal components.

- ▶ Transport of drive controllers on suitable pallets.
- ▶ Do not stack drive controllers or burden them with other heavy objects.

## NOTICE

### Damage to the coolant connections

#### Bending of the tubes!

- ▶ Never place the device on the coolant connections




---

**Drive controllers contain electrostatic sensitive components.**

- ▶ Avoid contact.
  - ▶ Wear ESD-protective clothing.
- 

Do not store drive controllers

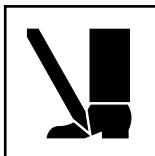
- in the environment of aggressive and/or conductive liquids or gases.
- with direct sunlight.
- outside the specified environmental conditions.

### 1.3 Installation

**⚠ DANGER**

**Do not operate in an explosive environment!**

- ▶ The COMBIVERT is not intended for the use in potentially explosive environment.
- 

**⚠ CAUTION**

**Design-related edges and high weight!**
**Contusions and bruises!**

- ▶ Never stand under suspended loads.
  - ▶ Wear safety shoes.
  - ▶ Secure drive controller accordingly when using lifting gear.
- 

To prevent damages to the device:

- Make sure that no components are bent and/or isolation distances are changed.
- The device must not be put into operation in case of mechanical defects.
- Do not allow moisture or mist to penetrate the unit.
- Avoid dust permeating the device. Allow for sufficient heat dissipation if installed in a dust-proof housing.
- Note installation position and minimum distances to surrounding elements. Do not cover the ventilation openings.
- Mount the drive controller according to the specified degree of protection.
- Make sure that no small parts fall into the COMBIVERT during assembly and wiring (drilling chips, screws etc.). This also applies to mechanical components, which can lose small parts during operation.
- Check the reliable fit of the device connections in order to avoid contact resistances and sparking.
- Do not walk-on drive controller.
- Follow all safety instructions!

## 1.4 Electrical connection

**⚠ DANGER****Voltage at the terminals and in the device !****Danger to life due to electric shock !**

- ▶ Never work on the open device or never touch exposed parts.
- ▶ For any work on the unit switch off the supply voltage, secure it against switching on and check absence of voltage by measurement.
- ▶ Wait until all drives has been stopped in order that no regenerative energy can be generated.
- ▶ Await capacitor discharge time (5 minutes) if necessary, measure DC voltage at the terminals.
- ▶ If personal protection is required, install suitable protective devices for drive converters.
- ▶ Never bridge upstream protective devices (also not for test purposes).
- ▶ Connect the protective earth conductor always to drive converter and motor.
- ▶ Install all required covers and protective devices for operation.
- ▶ The control cabinet shall be kept closed during operation.
- ▶ Residual current: This product may cause a dc current in the protective earth conductor. When a residual current protective device (RCD) or a residual current monitoring device (RCM) is used for the protection against direct or indirect contact, only a RCD or RCM type B is permitted on the power supply side of this product.
- ▶ Drive converters with a leakage current  $> 3.5\text{mA AC}$  current (10mA DC current) are intended for a stationary connection. Protective earth conductors must be designed in accordance with the local regulations for equipment with high leakage currents according to *EN 61800-5-1*, *EN 60204-1* or *DIN IEC 60364-5-54*.



If personnel protection is required during installation of the system, suitable protective devices must be used for drive controllers.

[www.keb.de/fileadmin/media/Techinfo/dr/tn/ti\\_dr\\_tn-rcd-00008\\_en.pdf](http://www.keb.de/fileadmin/media/Techinfo/dr/tn/ti_dr_tn-rcd-00008_en.pdf)



Installations which include drive controller shall be equipped with additional control and protective devices in accordance with the relevant applicable safety requirements, e.g. act respecting technical equipment, accident prevention rules etc. They must always be complied with, also for drive controller bearing a CE marking.



For a trouble-free and safe operation, please pay attention to the following instructions:

- The electrical installation shall be carried out in accordance with the relevant requirements.
- Cable cross-sections and fuses must be dimensioned by the user according to the specified minimum/maximum values for the application.
- The wiring must be made with flexible copper cable for a temperature  $> 75^{\circ}\text{C}$ .
- Connection of the drive converter is only permissible on symmetrical networks with a maximum line voltage (L1, L2, L3) with respect to earth (N/PE) of max. 300 V. An isolating transformer must be used for supply networks which exceed this value! In case of non-compliance the control is not longer considered to be a PELV circuit.
- With existing or newly wired circuits the person installing the units or machines must ensure that the PELV requirements are met.
- For drive converters that are not isolated from the supply circuit (in accordance with [EN 60721-3-1](#) all control lines must be included in other protective measures (e.g. double insulation or shielded, earthed and insulated).
- When using components without isolated inputs/outputs, it is necessary that equipotential bonding exists between the components to be connected (e.g. by the equipotential line). Disregard can cause destruction of the components by equalizing currents.

#### 1.4.1 EMC-compatible installation

Observance of the limit values required by EMC law is the responsibility of the customer.



Notes on EMC-compatible installation can be found here.  
[www.keb.de/fileadmin/media/Manuals/dr/emv/0000neb0000.pdf](http://www.keb.de/fileadmin/media/Manuals/dr/emv/0000neb0000.pdf)



#### 1.4.2 Voltage test

Testing with AC voltage (in accordance with [EN 60204-1](#) chapter 18.4) may not be executed, since there is danger for the power semiconductors in the drive controller.



Due to the radio interference suppression capacitors, the test generator will switch off immediately with a current fault.



According to [EN 60204-1](#) it is permissible to disconnect already tested components. Drive controllers of the KEB Automation KG are delivered ex works voltage tested to 100% according to product standard.

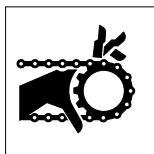
#### 1.4.3 Insulation measurement

An insulation measurement (in accordance with [EN 60204-1](#) chapter 18.3) with DC 500 V is permissible, if all power unit connections (grid-connected potential) and all control connections are bridged with PE. The insulation resistance of the respective device can be found in the technical data.

## 1.5 Start-up and operation

The drive controller must not be started until it is determined that the installation complies with the machine directive; Account is to be taken of [EN 60204-1](#).

### ⚠ WARNING



#### Software protection and programming!

##### Hazards caused by unintentional behavior of the drive!

- ▶ Check especially during initial start-up or replacement of the drive controller if parameterization is compatible to application.
- ▶ Securing a unit solely with software-supported functions is not sufficient. It is imperative to install external protective measures (e.g. limit switch) that are independent of the drive controller.
- ▶ Secure motors against automatic restart.

### ⚠ CAUTION



#### High temperatures at heat sink and coolant!

##### Burning of the skin!

- ▶ Cover hot surfaces safe-to-touch.
- ▶ If necessary, attach warning signs on the system.
- ▶ Before touching, check the surface and coolant lines.
- ▶ Before working let the unit cool down.

- During operation, all covers and doors shall be kept closed.
- Use only approved accessories for this device.
- Never touch terminals, busbars or cable ends.



If a drive controller with electrolytic capacitors in a DC link has not been in operation for more than one year, observe the following instructions.

[https://www.keb.de/fileadmin/media/Techinfo/dr/tn/ti\\_dr\\_tn-format-capacitors-00009\\_en.pdf](https://www.keb.de/fileadmin/media/Techinfo/dr/tn/ti_dr_tn-format-capacitors-00009_en.pdf)



### NOTICE

#### Continuous operation (S1) with load > 60 %!

##### Premature ageing of the electrolytic capacitors!

- ▶ Insert mains choke with  $U_k = 4\%$ .
- ▶ From a rated motor power of 55 kW, a mains choke with  $U_k = 4\%$  must be used!

**Switching at the output**

Switching between motor and drive controller is prohibited for single drives during operation as this may trigger the protection gear of the device. Function ‚speed search‘ must be activated if switching can not be avoided. Speed search may only be triggered after closing the motor contactor (e.g. by switching the control release).

Connecting and disconnecting is permissible with multiple motor drives if at least 1 motor is running during the switch-over process. The drive controller must be dimensioned to the occurring starting currents.

The ‚speed search‘ function must be activated if the motor is still running during a restart of the drive controller (mains on) (e.g. due to large rotating masses).

**Switching at the input**

For applications that require cyclic switching off and on of the drive controller, maintain an off-time of at least 5 min after the last switch on. If you require shorter cycle times please contact KEB Automation KG.

**Short-circuit resistance**

The drive converters are conditional short-circuit proof. After resetting the internal protection devices, the function as directed is guaranteed.

Exceptions:

- If an earth-leakage fault or short-circuit often occurs at the output, this can lead to a defect in the unit.
- If a short-circuit occurs during regenerative operation (2nd or 4th quadrant, regeneration into the DC link), this can lead to a defect in the unit.

**1.6 Maintenance**

The following maintenance work has to be carried out when required, but at least once per year by authorized and trained personnel. Check unit for loose screws and plugs and tighten if necessary.

- ▶ Check system for loose screws and plugs and tighten if necessary.
- ▶ Clean drive controller from dirt and dust deposits. Pay attention especially to cooling fins and protective grid of the fans.
- ▶ Examine and clean extracted air filter and cooling air filter of the control cabinet.
- ▶ Check the function of the fans of the drive controller. The fan must be replaced in case of audible vibrations or squeak.
- ▶ In the case of liquid-cooled drive controllers a visual test of the cooling circuit for leaks and corrosion must be carried out. The cooling circuit must be completely empty if a unit shall be switched off for a longer period. The cooling circuit must be blown out additionally with compressed air at temperatures below 0°C.

## 1.7 Repair

In case of malfunction, unusual noises or smells inform a person in charge!

### DANGER



#### Unauthorized exchange, repair and modifications!

##### Unpredictable malfunctions!

- ▶ The function of the drive controller is dependent on its parameterization. Never replace without knowledge of the application.
- ▶ Modification or repair is permitted only by KEB Automation KG authorized personnel.
- ▶ Only use original manufacturer parts.
- ▶ Infringement will annul the liability for resulting consequences.

In case of failure, please contact the machine manufacturer. Only the machine manufacturer knows the parameterisation of the used drive controller and can provide an appropriate replacement or induce the maintenance.

## 1.8 Disposal

Electronic devices of the KEB Automation KG are exclusively professional devices for further industrial processing (so-called B2B devices).

Manufacturers of B2B devices are obliged to take back and recycle devices manufactured after 14.08.2018. These devices may not be disposed at the collection centres of public sector disposal organisations.



If no deviating agreement has been made between the customer and KEB or no deviating mandatory legal regulation exists, KEB products marked in this way can be returned. Company and keyword to the return point can be taken from the list below. Shipping costs are paid by the customer. Thereupon the devices will be professionally recycled and disposed.

The entry numbers are listed country-specific in the following table. The corresponding KEB return addresses can be found on our website.

Withdrawal by	WEEE-Reg.-No.	Keyword
<b>Austria</b>		
KEB Automation GmbH	ERA: 51976	Stichwort „Rücknahme WEEE“
<b>France</b>		
RÉCYLUM - Recycle point	ADEME: FR021806	Mots clés „KEB DEEE“
<b>Germany</b>		
KEB Automation KG	EAR: DE12653519	Stichwort „Rücknahme WEEE“
<b>Italy</b>		
COBAT	AEE: (IT) 19030000011216	Parola chiave „Ritiro RAEE“
<b>Spain</b>		
KEB Automation KG	RII-AEE 7427	Palabra clave „Retirada RAEE“
<b>Česko</b>		
KEB Automation KG	RETELA 09281/20 ECZ	Klíčové slovo: Zpětný odběr OEEZ

The packaging must be feed to paper and cardboard recycling.

## 2 Product Description

The device series COMBIVERT G6 concerns to drive controllers, which have been developed for the universal use at open-loop three-phase drives. The COMBIVERT is optimized for the operation at synchronous and asynchronous motors and equipped with an integrated EMC filter.

The COMBIVERT meets the requirements of the Low-Voltage Directive. The harmonized standards of the series *EN 61800-5-1* for drive controllers were used.

The COMBIVERT is a product of limited availability in accordance with *EN 61800-3*. This product may cause radio interference in residential areas. In this case the operator may need to take corresponding measures.

The machine directive, EMC directive, Low Voltage Directive and other guidelines and regulations must be observed depending on the version.

### 2.1 Specified application

The COMBIVERT serves exclusively for the control and regulation of three-phase motors. It is intended for the installation into electrical systems or machines.

Technical data and information for connection conditions shall be taken from the type plate and from the instruction manual and must be strictly observed.

The used semiconductors and components of the KEB Automation KG are developed and dimensioned for the use in industrial products.

#### **Restriction**

If the product is used in machines, which work under exceptional conditions or if essential functions, life-supporting measures or an extraordinary safety step must be fulfilled, the necessary reliability and security must be ensured by the machine builder.

#### 2.1.1 Residual risks

Despite intended use, the drive controller can reach unexpected operating conditions in case of error, with wrong parameterization, by faulty connection or unprofessional interventions and repairs. This can be:

- Wrong direction of rotation
- Motor speed too high
- Motor is running into limitation
- Motor can be under voltage even in standstill
- Automatic start

### 2.2 Unintended use

The operation of other electric consumers is prohibited and can lead to the destruction of the unit. The operation of our products outside the indicated limit values of the technical data leads to the loss of any liability claims.

## 2.3 Product features

This instruction manual describes the power circuits of the following devices:

Device type:	Drive controller
Series:	COMBIVERT G6
Power range:	0.75...1.5 kW / 230 V 0.75...2.2 kW / 400 V
Housing:	A

The COMBIVERT G6 is characterized by the following features:




- Operation of three-phase asynchronous motors and three-phase synchronous motors, in operating modes open-loop or closed-loop without speed feedback
- Following fieldbus systems are supported: EtherCAT, VARAN, IO-Link or CAN-Open
- Comprehensive operating concept
- Wide operating temperature range
- Low switching losses by IGBT power unit
- Low noise development due to high switching frequencies
- Different heat sink concepts:
  - Air cooler as built-in version
  - Flat rear version
- Temperature-controlled fans, replaceable
- Depending on the operating mode, the torque limits and s-curves are adjustable (to protect the gearbox)
- General protection functions of the COMBIVERT series against overcurrent, overvoltage, ground fault and overtemperature
- Analog inputs and outputs, digital inputs and outputs, brake control and supply, motor protection by I<sup>2</sup>t, KTY or PTC input, diagnostic interface, fieldbus interface (depending on the control board)
- Potential-free relay output

### 2.4 Part code

<b>x x</b>	<b>G6</b>	<b>x</b>	<b>x</b>	<b>x</b>	<b>-x</b>	<b>x</b>	<b>x</b>	<b>x</b>	
Heat sink version <sup>4)</sup>									0: Air-cooling 1: Flat rear
Control, Keyboard, Display <sup>4)</sup>									A: G6L-G controlled without keyboard / display B: G6L-G controlled with keyboard / display 0: G6-G controlled without keyboard / display 1: G6-G controlled with keyboard / display 2: G6P-S SCL <sup>5)</sup> regulated without keyboard / display 3: G6P-S SCL <sup>5)</sup> regulated with keyboard / display 4: G6L-M ASCL <sup>6)</sup> regulated without keyboard / display 5: G6L-M ASCL <sup>6)</sup> regulated with keyboard / display
Switching frequency; Short time current limit; Overcurrent cut-off <sup>4)</sup>									5: 4 kHz / 150% / 180% 9: 4 kHz / 180% / 216% A: 8 kHz / 180% / 216%
Voltage / Connection type <sup>4)</sup>									0: 1ph 230 V AC/DC 3: 3ph 400 V AC/DC 5: 3ph 400 V DC A-Z: Customer- / special version (firmware, hardware, download)
Housing									A, B, C, E
Equipment									Without filter, without braking transistor, without safety function STO 0: safety function STO 1: Without filter, with braking transistor, without safety function STO 3: Internal filter, with braking transistor, without safety function STO A: Like 0 with STO B: Like 1 with STO D: Like 3 with STO H: Like A with f=0 Hz I: Like B with f=0 Hz L: Like D with f=0 Hz
Control type									C: Analog / digital (standard) D: CAN <sup>® 2)</sup> E: IO-Link <sup>® 3)</sup> F: EtherCAT <sup>® 1)</sup> I: VARAN
Series									COMBIVERT G6
Inverter size									07...19

Table 1: Part code

*continued on the next page*

- 1)  *EtherCAT® is registered trademark and patented technology, licensed by Beckhoff Automation GmbH, Germany*
- 2)  *CANopen® is registered trademark of CAN in AUTOMATION - International Users and Manufacturers Group e.V.*
- 3)  *IO-LINK® is registered trademark of PROFIBUS user organisation e.V.*
- 4) *Not valid for customer/special versions*
- 5) *SCL = Sensorless Closed Loop*
- 6) *ASCL = Asynchronous Sensorless Closed Loop*



The part code may not be used as order code, but only for identification!

---



### 3 Technical Data

Unless otherwise indicated, all electrical data in the following chapter refer to a 3-phase AC voltage supply.

#### 3.1 Operating conditions

##### 3.1.1 Climatic ambient conditions

Storage		Standard	Class	Notes
Surrounding temperature		EN 60721-3-1	1K4	-25...55 °C
Relative humidity		EN 60721-3-1	1K3	5...95 % (without condensation)
Storage height		–	–	Max. 3000 m above sea level
Transport		Standard	Class	Notes
Surrounding temperature		EN 60721-3-2	2K3	-25...70 °C
Relative humidity		EN 60721-3-2	2K3	95 % at 40 °C (without condensation)
Operation		Standard	Class	Notes
Surrounding temperature		EN 60721-3-3	3K3	5...40 °C (extended to -10...45 °C)
Coolant inlet temperature	Air	–	–	5...40 °C (-10...45 °C)
	Liquid	–	–	5...40 °C
Relative humidity		EN 60721-3-3	3K3	5...85 % (without condensation)
Version and degree of protection		EN 60529	IP20	Protection against foreign material > ø12.5 mm No protection against water Non-conductive pollution, occasional condensation when PDS is out of service.
Site altitude		–	–	Max. 2000 m above sea level <ul style="list-style-type: none"> <li>With site altitudes over 1000 m a derating of 1 % per 100 m must be taken into consideration.</li> <li>With site altitudes over 2000 m, the control board to the mains has only basic isolation. Additional measures must be carried out when wiring the control system.</li> </ul>

Table 2: Climatic ambient conditions

**3.1.2 Mechanical ambient conditions**

Storage		Standard	Class	Notes
Vibration limits		<a href="#">EN 60721-3-1</a>	1M2	Vibration amplitude 1.5mm (2...9Hz) Acceleration amplitude 5 m/s <sup>2</sup> (9...200Hz)
Shock limit values		<a href="#">EN 60721-3-1</a>	1M2	40 m/s <sup>2</sup> ; 22 ms
Transport		Standard	Class	Notes
Vibration limits		<a href="#">EN 60721-3-2</a>	2M1	Vibration amplitude 3.5mm (2...9Hz) Acceleration amplitude 10 m/s <sup>2</sup> (9...200 Hz) (Acceleration amplitude 15 m/s <sup>2</sup> (200...500 Hz)) <sup>1)</sup>
Shock limit values		<a href="#">EN 60721-3-2</a>	2M1	100 m/s <sup>2</sup> ; 11 ms
Operation		Standard	Class	Notes
Vibration limits		<a href="#">EN 60721-3-3</a>	3M4	Vibration amplitude 3.5mm (2...9Hz) Acceleration amplitude 10 m/s <sup>2</sup> (9...200Hz)
		<a href="#">EN 61800-5-1</a>	–	Vibration amplitude 0.075mm (10...57 Hz) Acceleration amplitude 10 m/s <sup>2</sup> (57...150Hz)
Shock limit values		<a href="#">EN 60721-3-3</a>	3M4	100 m/s <sup>2</sup> ; 11 ms

*Table 3: Mechanical ambient conditions*

<sup>1)</sup> Not tested.

**3.1.3 Chemical / mechanical active substances**

Storage		Standard	Class	Notes
Contamination	Gases	<a href="#">EN 60721-3-1</a>	1C2	–
	Solids		1S2	–
Transport		Standard	Class	Notes
Contamination	Gases	<a href="#">EN 60721-3-2</a>	2C2	–
	Solids		2S2	–
Operation		Standard	Class	Notes
Contamination	Gases	<a href="#">EN 60721-3-3</a>	3C2	–
	Solids		3S2	–

*Table 4: Chemical / mechanical active substances*

### 3.1.4 Electrical operating conditions

#### 3.1.4.1 Device classification

Requirement	Standard	Class	Notes
Overvoltage category	EN 61800-5-1	III	–
	EN 60664-1		–
Pollution degree	EN 60664-1	2	Non-conductive pollution, occasional condensation when PDS is out of service

Table 5: Device classification

#### 3.1.4.2 Electromagnetic compatibility

For devices without an internal filter, an external filter is required to comply with the following limit values.

EMC emitted interference	Standard	Class	Notes
Cable-based interferences	EN 61800-3	C2	–
Radiated interferences	EN 61800-3	C2	–
Interference immunity	Standard	Level	Notes
Static discharges	EN 61000-4-2	8 kV 4 kV	AD (air discharge) CD (contact discharge)
Burst - Ports for process measurement control lines and signal interfaces	EN 61000-4-4	2 kV	–
Burst - Power ports	EN 61000-4-4	4 kV	–
Surge - Power ports	EN 61000-4-5	1 kV 2 kV	Phase-phase Phase-ground
Immunity to conducted disturbances, induced by radio-frequency fields	EN 61000-4-6	10 V	0.15...80 MHz
Electromagnetic fields	EN 61000-4-3	10 V/m 3 V/m 1 V/m	80 MHz...1 GHz 1.4...2 GHz 2...2.7 GHz
Voltage variation/ voltage drops	EN 61000-2-1 EN 61000-4-3	–	-15 %...+10 % 90 %
Frequency changes	EN 61000-2-4	–	≤ 2 %
Voltage deviations	EN 61000-2-4	–	±10 %
Voltage unbalance	EN 61000-2-4	–	≤ 3 %

Table 6: Electromagnetic compatibility

## 3.2 Technical data G6 230V devices

Device size		07	09
Housing		A	
Phases		1	
Rated apparent output power	$S_{out}$ / kVA	1.6	2.8
Max. rated motor power	$P_{mot}$ / kW	0.75	1.5
Rated output current	$I_N$ / A	4.0	7.0
Rated output current UL	$I_{N\_UL}$ / A	4.1	6.8
Short time current limit	<sup>1)</sup> $I_{HSR}$ / %	180	
Overcurrent	<sup>1)</sup> $I_{OC}$ / %	216	
Maximum current at 0Hz / corner frequency $f_d$ at $f_s=4$ kHz	<sup>1)</sup> $I_{f0/fd}$ / %	100/180	100/180
Maximum current at 0Hz / corner frequency $f_d$ at $f_s=8$ kHz	<sup>1)</sup> $I_{f0/fd}$ / %	100/180	100/150
Corner frequency	$f_d$ / Hz	6	
Rated input current	$I_{in}$ / A	8	14
Rated input current UL	$I_{in\_UL}$ / A	8	14
Max. permissible main fuse type gG	$I_{max}$ / A	20	20
Rated switching frequency	<sup>2)</sup> $f_{SN}$ / kHz	8	4
Max. switching frequency	<sup>2)</sup> $f_{S\_max}$ / kHz	8	8
Power dissipation at nominal operating	<sup>3)</sup> $P_D$ / W	45	63
Power dissipation standby (no control release)	<sup>3)</sup> $P_{D\_nop}$ / W	8	
Max. heat sink temperature	$T_{HS}$ / °C	90	
Temperature for derating the switching frequency	<sup>4)</sup> $T_{dr}$ / °C	85	
Temperature for uprating the switching frequency	<sup>4)</sup> $T_{ur}$ / °C	80	
Min. braking resistor	$R_{B\_min}$ / $\Omega$	56	
Max. braking current	$I_{B\_max}$ / A	7,5	
Rated input voltage	$U_N$ / V	230 (UL: 240)	
Input voltage range	$U_{in}$ / V	195...264 $\pm$ 0	
Mains frequency	$f_N$ / Hz	50 / 60 $\pm$ 2	
Rated input voltage DC	$U_{N\_dc}$ / V	325 (UL: 340)	
Input voltage range at DC supply	$U_{in\_dc}$ / V	275...373 $\pm$ 0	
DC switch-off level "Error! Underpotential"	$U_{UP\_dc}$ / V	216	
Switching level DC braking resistor	$U_{B\_dc}$ / V	380	
DC switch-off level "Error! Overpotential"	$U_{OP\_dc}$ / V	400	
Output voltage	<sup>5)</sup> $U_{out}$ / V	3 x 0... $U_{in}$	
Output voltage at DC devices	<sup>5)</sup> $U_{out\_dc}$ / V	3 x 0... $U_{in\_dc} / \sqrt{2}$	
Output frequency (depending on the operating mode)	<sup>2)</sup> $f_{out}$ / Hz	0...400 ( $f_s = 4$ kHz) 0...599 ( $f_s = 8$ kHz)	
Insulation resistance @ $U_{dc} = 500$ V	$R_{iso}$ / M $\Omega$	10	
Minimum waiting period between two switch-on procedures	$t$ / min	5	

Table 7: Technical data 230V devices

- <sup>1)</sup> The values refer percentage to the rated output current  $I_N$ .
- <sup>2)</sup> The output frequency is to be limited in such a way that it does not exceed 1/10 of the switching frequency.
- <sup>3)</sup> Rated operation corresponds to  $U_N = 230$  V;  $f_{SN}$ ;  $f_{out} = 50$  Hz (typically value).
- <sup>4)</sup> On reaching the temperature  $T_{dr}$  the switching frequency is step down. The switching frequency is increased again on cooling down to temperature  $T_{ur}$ .
- <sup>5)</sup> The voltage at the motor is dependent on the series-connected units and on the control method, => „4.2 Connection of the power unit“.



The technical data are for 2/4-pole standard motors. With other pole numbers the drive controller must be dimensioned onto the rated motor current. Contact KEB for special or medium frequency motors.

### 3.3 Technical data G6 400V devices

Device size		07	09	10
Housing		A		
Phases		3		
Rated apparent output power	$S_{out}$ / kVA	1.8	2.8	4.0
Max. rated motor power	$P_{mot}$ / kW	0.75	1.5	2.2
Rated output current	$I_N$ / A	2.6	4.1	5.8
Rated output current UL	$I_{N\_UL}$ / A	1.8	3.4	4.8
Short time current limit	<sup>1)</sup> $I_{HSR}$ / %	180		
Overcurrent	<sup>1)</sup> $I_{OC}$ / %	216		
Maximum current at 0Hz / corner frequency $f_d$ at $f_s = 4$ kHz	<sup>1)</sup> $I_{f0/fd}$ / %	100 / 180	100 / 180	100 / 180
Maximum current at 0Hz / corner frequency $f_d$ at $f_s = 8$ kHz	<sup>1)</sup> $I_{f0/fd}$ / %	100 / 180	100 / 150	85 / 150
Corner frequency	$f_d$ / Hz	6		
Rated input current	$I_{in}$ / A	3.6	6.0	8.0
Rated input current UL	$I_{in\_UL}$ / A	2.5	4.8	7.0
Rated input current DC	<sup>2)</sup> $I_{in\_dc}$ / A	1.9	3.7	5.2
Rated input current UL DC	<sup>2)</sup> $I_{in\_UL\_dc}$ / A	1.6	3.0	4.2
Max. permissible main fuse type gG	$I_{max}$ / A	16	16	16
Rated switching frequency	<sup>3)</sup> $f_{SN}$ / kHz	8	4	4
Max. switching frequency	<sup>3)</sup> $f_{S\_max}$ / kHz	8	8	8
Power dissipation at nominal operating	<sup>4)</sup> $P_D$ / W	45	49	70
Power dissipation standby (no control release)	<sup>4)</sup> $P_{D\_nop}$ / W	10		
Max. heat sink temperature	$T_{HS}$ / °C	90		
Temperature for derating the switching frequency	<sup>5)</sup> $T_{dr}$ / °C	85		
Temperature for uprating the switching frequency	<sup>5)</sup> $T_{ur}$ / °C	80		
Min. braking resistor	$R_{B\_min}$ / Ω	120		
Max. braking current	$I_{B\_max}$ / A	7		
Rated input voltage	$U_N$ / V	400 (UL: 480)		
Input voltage range	$U_{in}$ / V	340...528 ±0		
Mains frequency	$f_N$ / Hz	50 / 60 ±2		
Rated input voltage DC	$U_{N\_dc}$ / V	565 (UL: 680)		
Input voltage range at DC supply	$U_{in\_dc}$ / V	480...746 ±0		
DC switch-off level "Error! Underpotential"	$U_{UP\_dc}$ / V	240		
Switching level DC braking resistor	$U_{B\_dc}$ / V	780		
DC switch-off level "Error! Overpotential"	$U_{OP\_dc}$ / V	840		
Output voltage	<sup>6)</sup> $U_{out}$ / V	3 x 0... $U_{in}$		
Output voltage at DC devices	<sup>6)</sup> $U_{out\_dc}$ / V	3 x 0... $U_{in\_dc} / \sqrt{2}$		
Output frequency (depending on the operating mode)	<sup>3)</sup> $f_{out}$ / Hz	0...400 ( $f_s = 4$ kHz) 0...599 ( $f_s = 8$ kHz)		
Insulation resistance @ $U_{dc} = 500$ V	$R_{iso}$ / MΩ	10		
Minimum waiting period between two switch-on procedures	$t$ / min	5		

Table 8: Technical data 400V devices

- <sup>1)</sup> The values refer percentage to the rated output current  $I_N$ .
- <sup>2)</sup> The values resulting from rated operation with B6 rectifier circuit and mains choke 4%  $U_k$ .
- <sup>3)</sup> The output frequency is to be limited in such a way that it does not exceed 1/10 of the switching frequency.
- <sup>4)</sup> Rated operation corresponds to  $U_N = 400$  V;  $f_{SN}$ ;  $f_{out} = 50$  Hz (typically value).
- <sup>5)</sup> On reaching the temperature  $T_{dr}$  the switching frequency is step down. The switching frequency is increased again on cooling down to temperature  $T_{ur}$ .
- <sup>6)</sup> The voltage at the motor is dependent on the series-connected devices and on the control method, => „4.2 Connection of the power unit“.



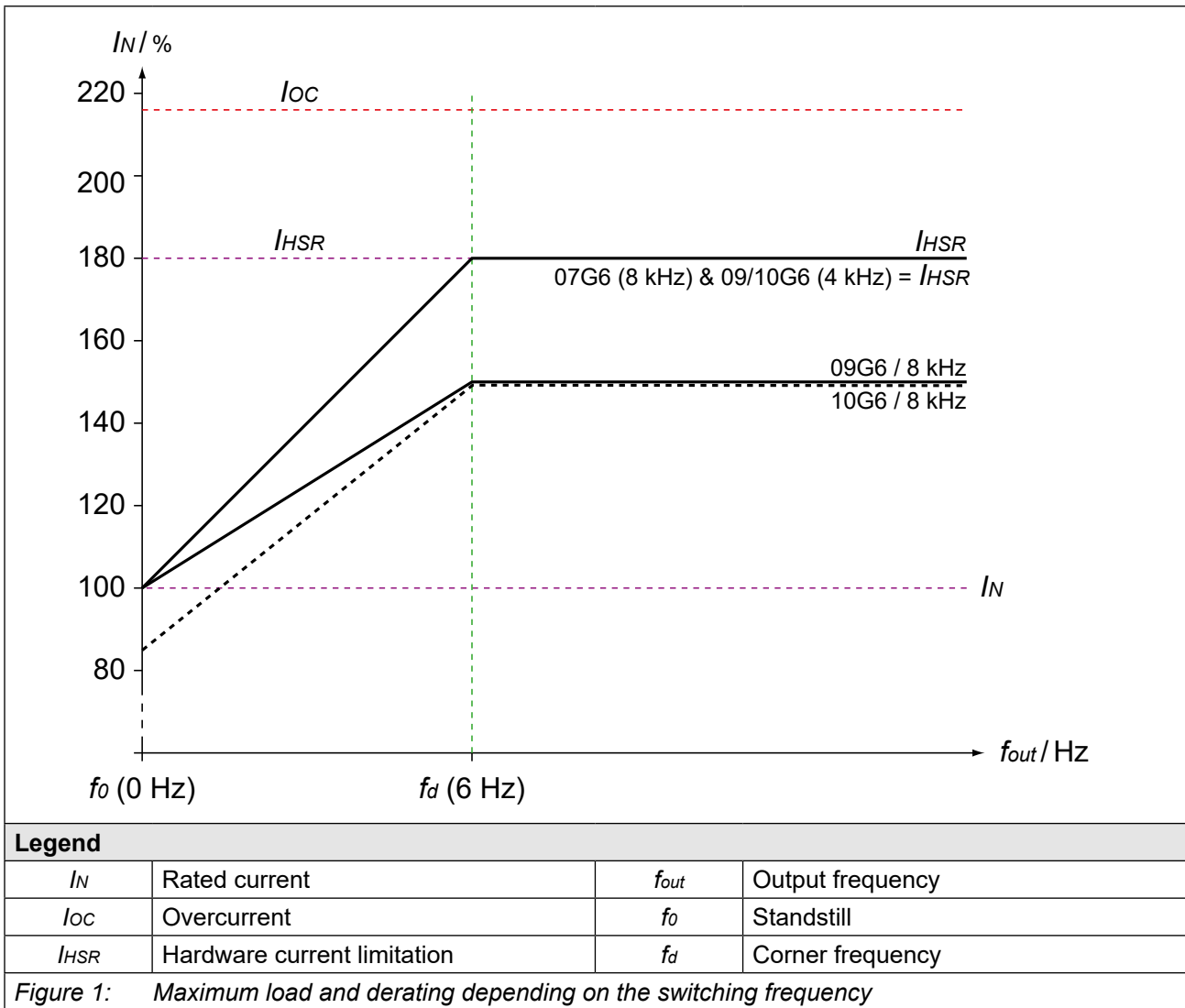
The technical data are for 2/4-pole standard motors. With other pole numbers the drive controller must be dimensioned onto the rated motor current. Contact KEB for special or medium frequency motors.

The service life of drive controllers with voltage DC link depends on the current load of the electrolytic capacitors in the DC link. The use of mains chokes can increase the service life of the condensators to a considerable extent, especially when connecting to „hard“ power systems or when under permanent drive load (continuous duty).

The term "hard" power system means that the nodal point power ( $S_{net}$ ) of the mains is very high ( $\gg 200$ ) compared to the output rated power of the drive controller ( $S_{out}$ ).

$k = \frac{S_{net}}{S_{out}} \gg 200$	e.g.	$k = \frac{2\text{MVA (supply transformer)}}{6.6\text{kVA (12G6)}} = 303 \rightarrow \text{Choke required}$
---------------------------------------	------	---

**3.3.1 Overload and derating**



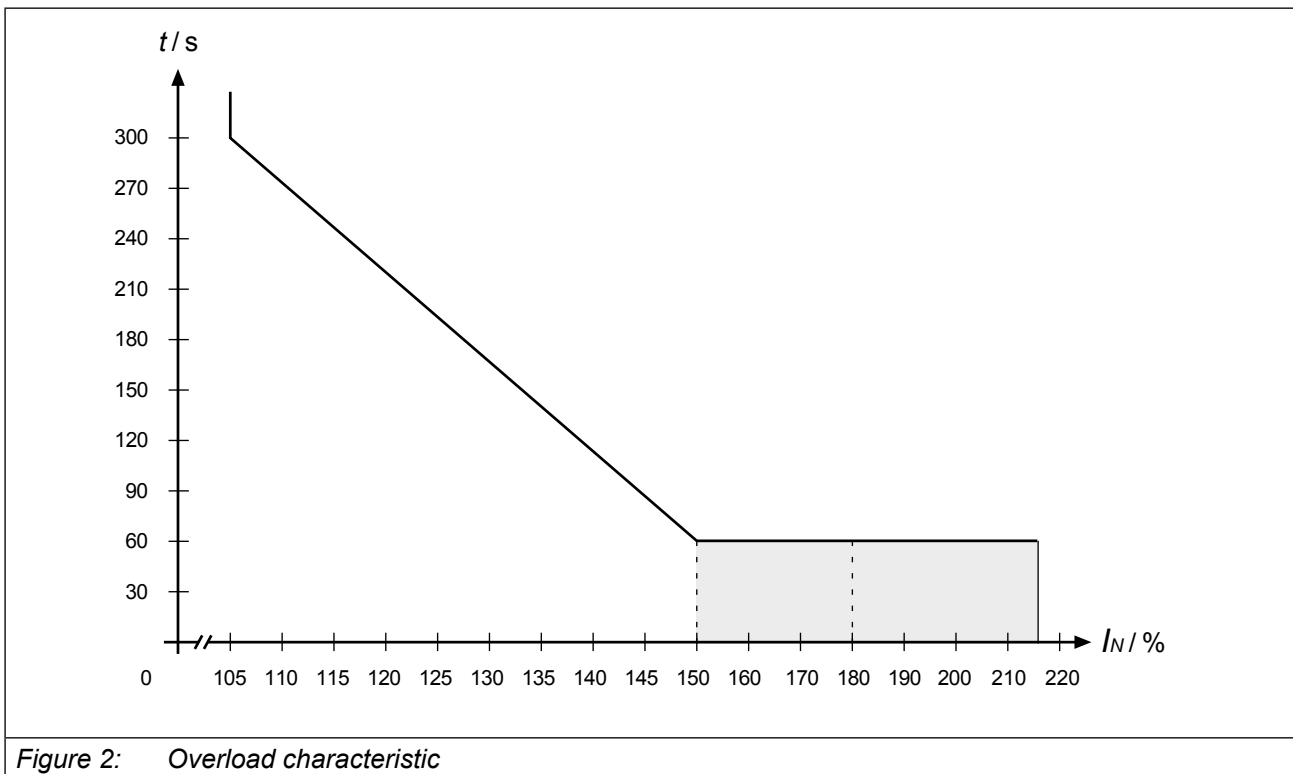
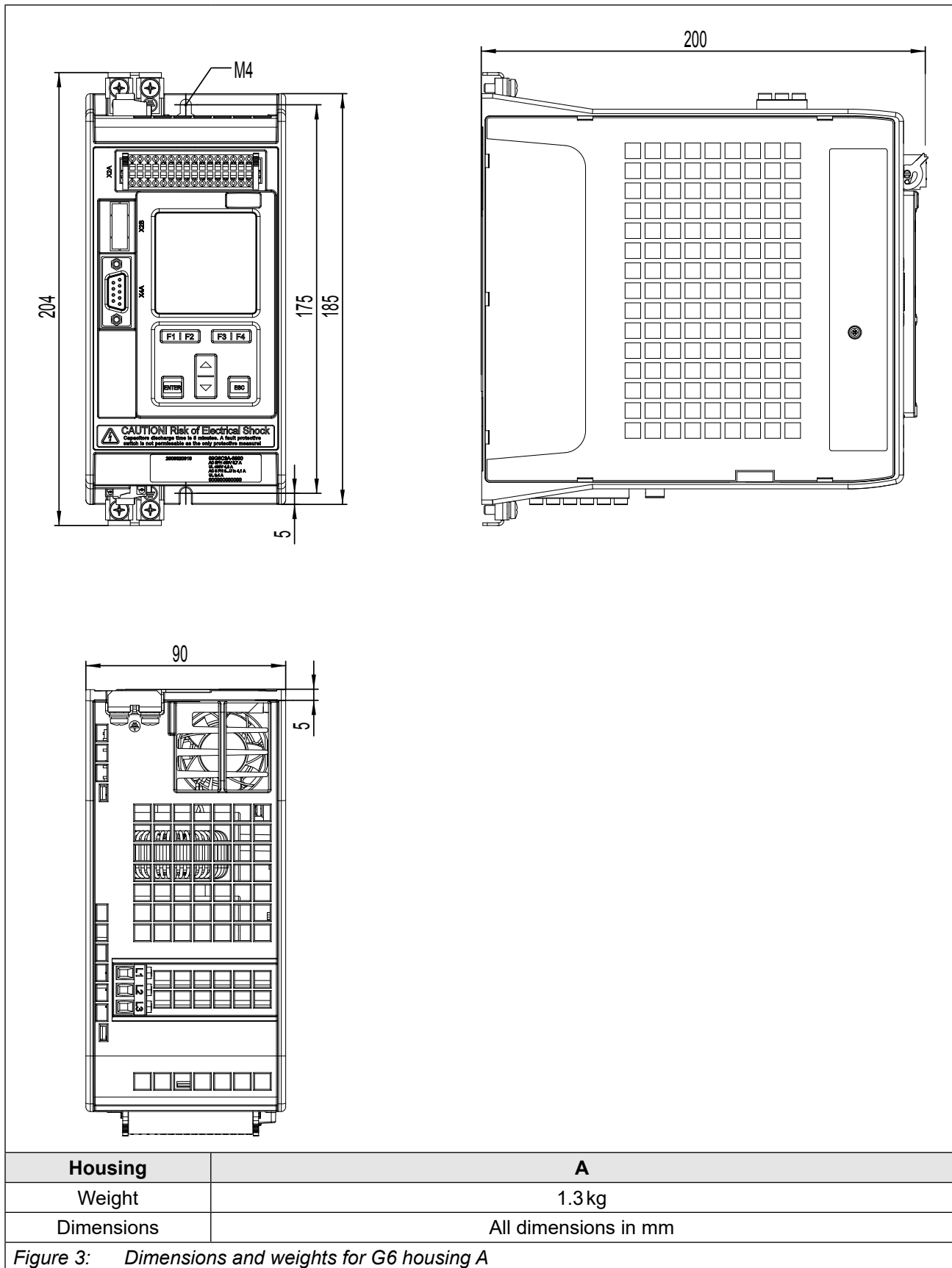


Figure 2: Overload characteristic

On exceeding a load of 105% the overload integrator starts. When falling below the integrator counts backwards. If the integrator achieves the overload characteristic that corresponds to the drive converter, „ERROR overload“ is triggered

After a cooling period the message „no ERROR overload“ is displayed. The error can be reset now. The drive converter must remain switched on during the cooling period.

**3.4 Dimensions and weights**





### 3.4.1 Control cabinet installation

The power dissipation for the control cabinet dimension is to be taken from the technical data. => „Hier Text oder Variable eingeben“.

Mounting distances	Dimension	Distance in mm	Distance in inch
	A	150	6
	B	100	4
	C	30	1.2
	D	0	0
	E	0	0
	F <sup>1)</sup>	50	2
	<sup>1)</sup> Distance to preceding elements in the control cabinet door.		

Figure 4: Mounting distances

#### 3.4.1.1 Ventilation in the control cabinet

If construction-conditioned the control cabinet cannot be without indoor ventilation, appropriate filters must avoid suction of foreign objects.



#### Installation of the drive converter

For reliable operation, the drive converter must be mounted without clearance on a smooth, closed, bare metal mounting plate.

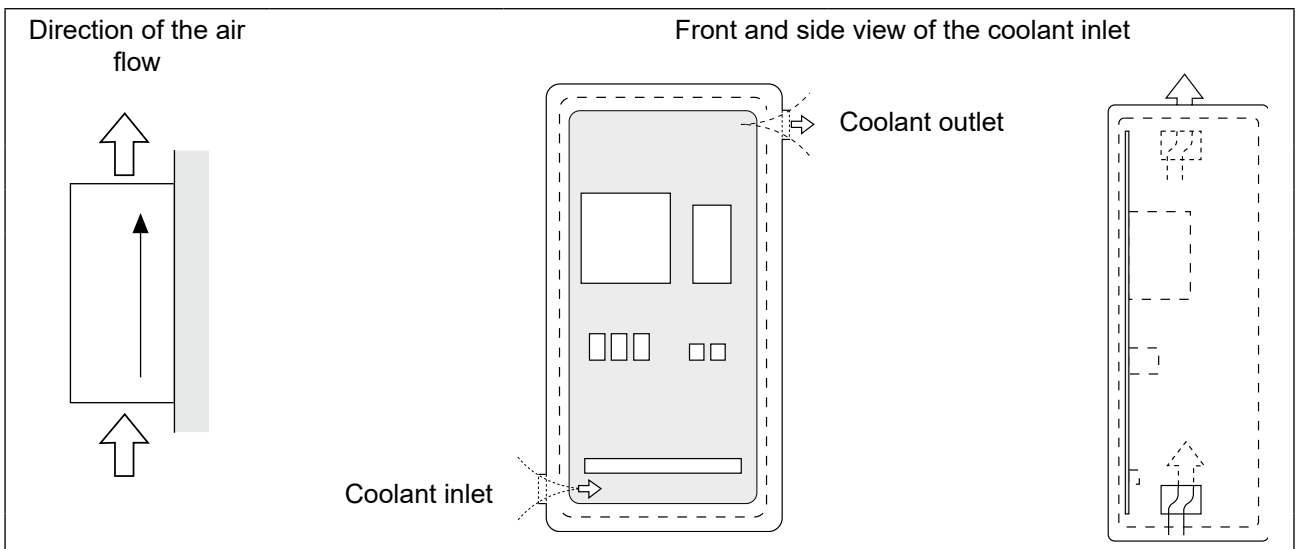


Figure 5: Control cabinet ventilation

## 4 Installation and Connection

### 4.1 Overview of the COMBIVERT G6

Housing A		No.	Name	Description
	1	X1B	Terminal strip for three-phase motor , braking resistor and DC supply	
	2	X1C	Temperature monitoring; Connection for external PTC or temperature switch	
	3	X4A	Diagnostic interface; RS232/485 interface with DIN66019-II	
	4	X2B	Safety function STO (optional)	
	5	X2A	Control terminal strip 32pole	
	6	X1A	Mains input	
	7	LED1	Drive controller state (there is no operator)	
	8	–	Operator with display and keyboard	
	9	–	Nameplate	
	10	PE, 	Protective earth; at connection to protective earth each terminal may be assigned only once. The shielding e.g. from the motor cable is laid on the mounting plate in the control cabinet or on the mounting kit (optionally available). => „6.1 Mounting kit shield connection braket“	

Figure 6: Overview of the COMBIVERT G6

## 4.2 Connection of the power unit

### 4.2.1 Connection of the voltage supply

The COMBIVERT G6-A corresponds to the drive controller type A1. This type can be supplied both by mains and via DC terminals. The starting current limiting is arranged before the DC link. When using as DC output parallel-connected drive controllers must have their own starting current limiting at the DC voltage input.

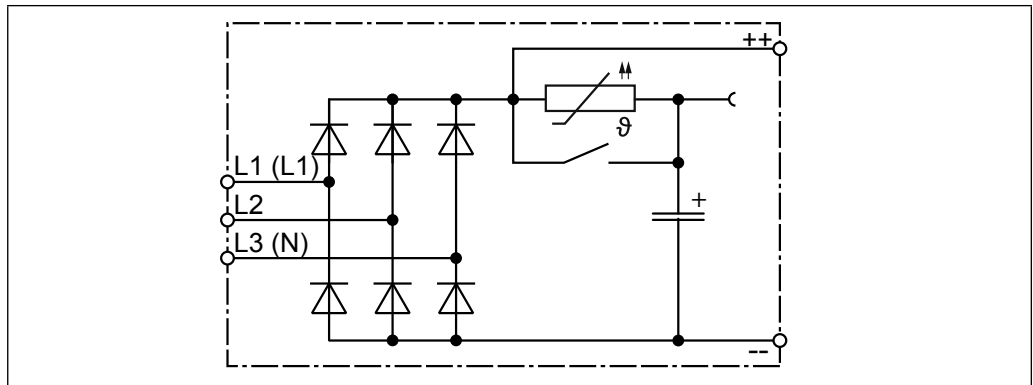


Figure 7: Input circuit/drive controller type

#### NOTICE

##### Unit switches off!

Cyclic switching on and off of the unit leads to temporary high resistance of the resistor (PTC) in the input. The device displays „Error! load shunt fault“ in this state. When switching the control release during this fault, the unit will switch off. A restart without limitation is possible after cooling. Waiting time => „3.3 Technical data G6 400V devices“.

#### 4.2.1.1 Wiring instructions

#### NOTICE

##### Note input voltage!

230 V and 400 V class possible.

#### NOTICE

##### Ensure the correct connection!

Never exchange the mains and motor cables.



Some countries demand that the PE-terminal is directly connected to the terminal box (not over the mounting plate).

## CONNECTION OF THE POWER UNIT

### 4.2.1.2 Line terminal strip X1A

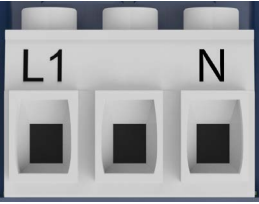
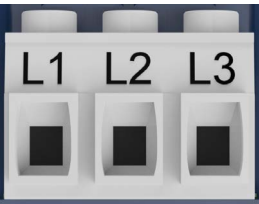


X1A	Name	Function	Cross-section		Tightening torque
	L1, N	Mains connection 1-phase	AWG without wire-end ferrule	mm <sup>2</sup> with wire-end ferrule	0.5...0.6A 5...6lb-inch
24...14			0.2...2.5		
	multi-wire				
	L1, L2, L3	Mains connection 3-phase	AWG without wire-end ferrule	mm <sup>2</sup> with wire-end ferrule	0.5...0.6A 5...6lb-inch
24...14			0.2...2.5		
	multi-wire				
	PE, 	Connection for protective earth	Screw M4 for ring crimp connector		1.3 Nm 11lb inch

Figure 8: Line terminal strip X1A

### 4.2.2 Leakage currents

Calculated maximum leakage currents depending on voltage and frequency.

Mains phases	Rated input voltage / V	Frequency / Hz	Leakage current / mA
1-phase	230	50	4.3
		60	5.2
	265	50	6.3
		60	7.2

Table 9: Leakage current 1-phase

Mains phases	Rated input voltage / V	Frequency / Hz	Leakage current / mA
3-phase	400	50 / 60	< 5

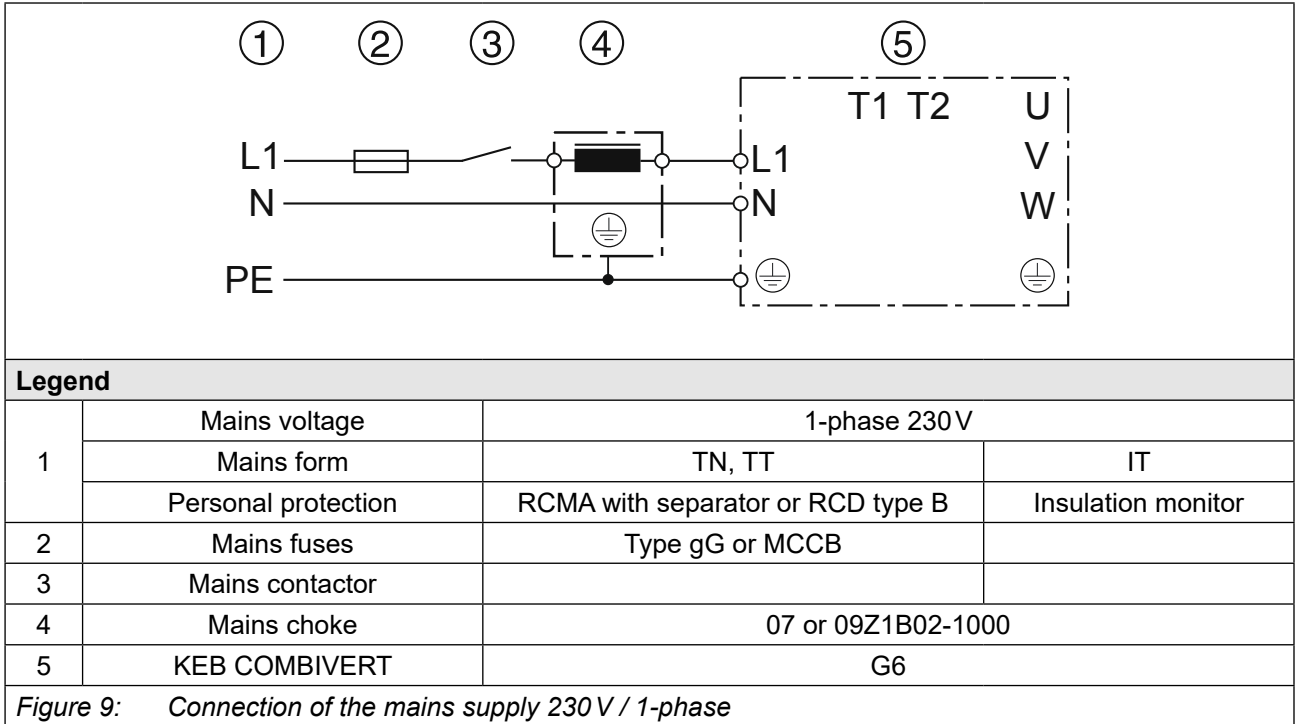
Table 10: Leakage currents 3-phase



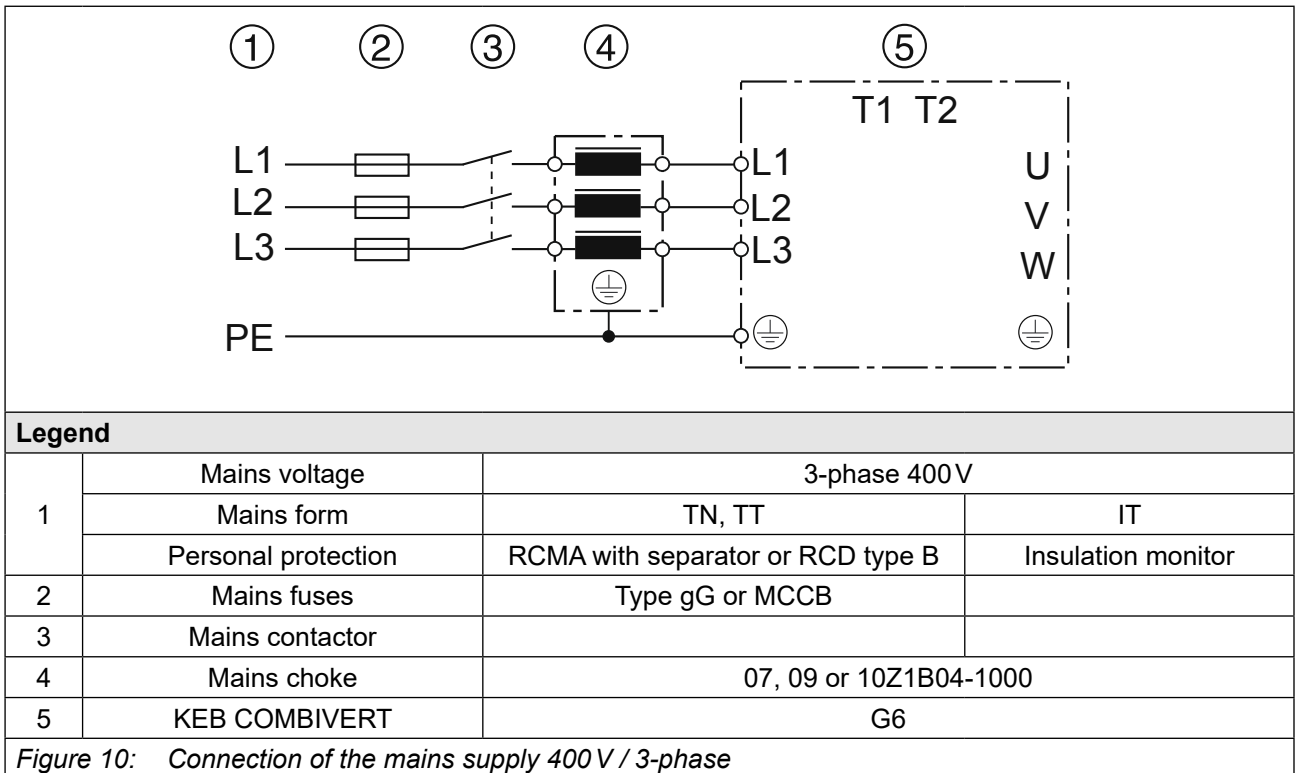
The specified leakage currents are calculated values according to *DIN EN 60939-1*. The real leakage currents may deviate from the calculated values depending on the network conditions.

4.2.3 AC connection

4.2.3.1 AC supply 230V / 1-phase



4.2.3.2 AC supply 400V / 3-phase

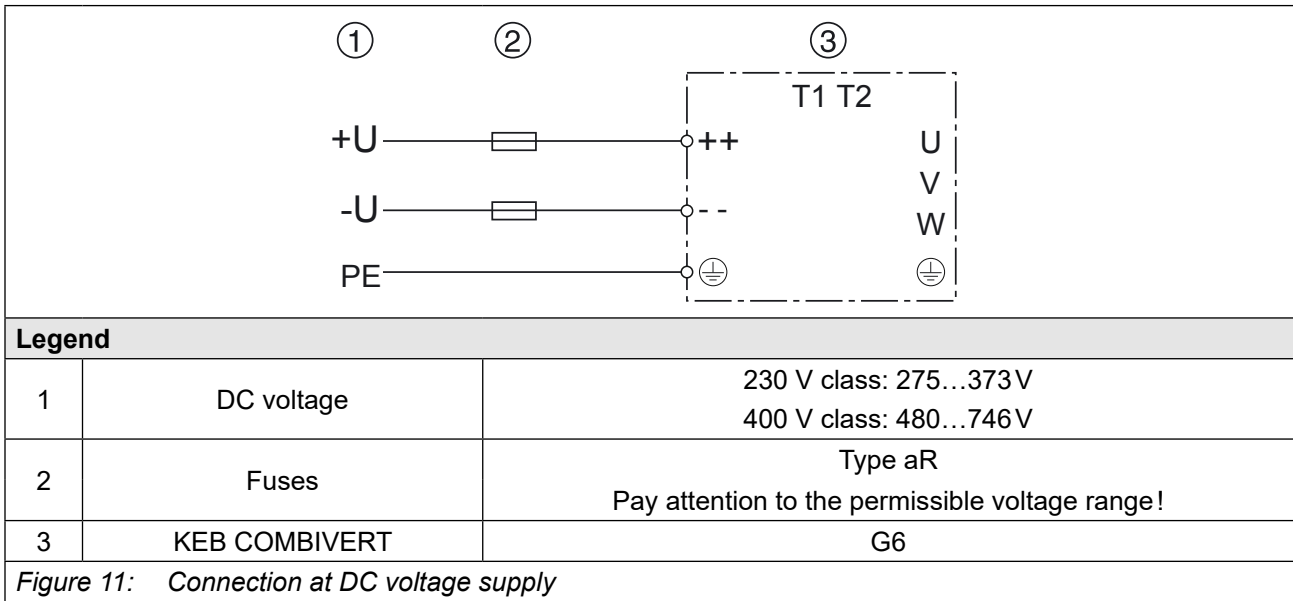


## CONNECTION OF THE POWER UNIT

### 4.2.3.3 Cross-section of the supply cable

The conductor cross-section of the supply cable is dependent on the input current, the cable according to manufacturer's data, as well as the VDE regulations.

### 4.2.4 Connection at DC voltage supply



#### 4.2.4.1 Terminal block X1B DC connection

X1B	Name	Function	Cross-section		Tightening torque
			AWG without wire-end ferrule	mm <sup>2</sup> with wire-end ferrule	
	++ , --	DC connection	24...14	0.25...2.5	0.5...0.6A 5...6 lb-inch
			multi-wire		
	PE, 	Connection for protective earth	Screw M4 for ring crimp connector		1.3 Nm 11 lb inch

Figure 12: Terminal block X1B DC connection

### 4.2.5 Connection of the motor

#### 4.2.5.1 Selection of the motor cable

The correct cabling as well as the motor cable play an important part in case of low power in connection with long motor line lengths. Ferrite cores and low-capacitance cables (phase/phase < 65 pF / m, phase/screen < 120 pF / m) at the output have the following effects:

- Longer motor cable lengths
- Less abrasion of the motor gearbox by leakage currents
- Better EMC properties

4.2.5.2 Cable-fed disturbances depending on the motor cable length at AC supply

The maximum motor cable length is depending on the capacity of the cable as well as on the EMC emitted interference. The following data apply for operation under rated conditions.

Size	Voltage / V	Max. motor cable length shielded in accordance with <i>EN 61800-3</i>			
		Category C1		Category C2	
		Motor cable / m (standard)	Motor cable / m (low-capacitance)	Motor cable / m (standard)	Motor cable / m (low-capacitance)
07	230	10	20	25	50
	400	25	50	50	100
09	230	15	30	25	50
	400	25	50	50	100
10	400	25	50	50	100

Table 11: Cable-fed disturbances depending on the motor cable length at AC supply



The cable length can be significantly extended by using motor chokes or filters. KEB recommends the use of motor chokes or filters for a line length upto 50 m. Motor chokes or filters are absolutely necessary upto 100 m.

4.2.5.3 Motor cable length at operation with DC voltage

The maximum motor cable length at DC operation is basically dependent on the capacity of the motor cable. The internal filter is not active at DC operation. External measures must be taken here, if necessary. The following data apply for operation under rated conditions.

Size	Motor cable / m (standard)	Motor cable / m (low-capacitance)
07	25	50
09		
10		

Table 12: Motor cable length at operation with DC voltage

4.2.5.4 Motor cable length for parallel operation of motors

The resulting motor cable length for parallel operation of motors, or parallel installation with multiple cables arises from the following formula:

$$\text{resulting motor cable length} = \sum \text{single cable lengths} \times \sqrt{\text{Number of motor cables}}$$

4.2.5.5 Motor cable cross-section

The motor cable cross-section is dependent

- on the kind of the output current (e.g. not sinusoidal).
- on the real effective value of the motor current.
- on the cable length.
- on the type of the used cable.
- on environmental conditions such as bundling and temperature.

4.2.5.6 Interconnection of the motor

**NOTICE**

**Faulty behaviour of the motor!**

The connecting-up instructions of the motor manufacturer are always generally valid!

**NOTICE**

**Protect motor against voltage peaks!**

Drive controllers switch at the output with  $dV/dt \leq 5kV/\mu s$ . Voltage peaks that endanger the insulation system at the motor can occur especially in case of long motor cables (>15 m).

A motor choke, a  $dv/dt$ -filter or sine-wave filter can be used for protection of the motor.

4.2.5.7 Terminal block X1B motor connection

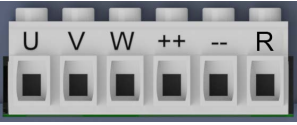
X1B	Name	Function	Cross-section		Tightening torque
	U, V, W	Motor connection	AWG without wire-end ferrule	mm <sup>2</sup> with wire-end ferrule	0.5...0.6A 5...6lb-inch
			24...14	0.25...2.5	
			stranded wire		

Figure 13: Terminal block X1B motor connection

4.2.5.8 Wiring of the motor

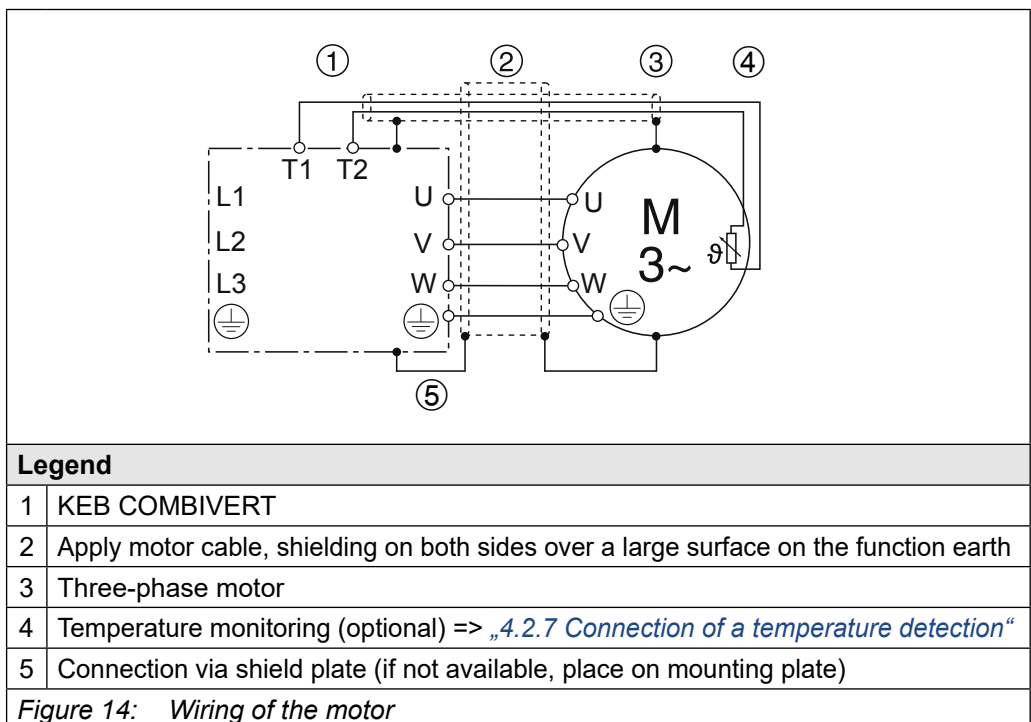


Figure 14: Wiring of the motor



**NOTICE**

**Ensure correct laying of the PTC cables !**

- Do not lay PTC cable of the motor (also shielded) together with control cable!
- PTC cable inside the motor cable only permissible with an additional shielding (double shielding)!

**4.2.6 Connection of a braking resistor**

4.2.6.1 Terminal block X1B connection braking resistor

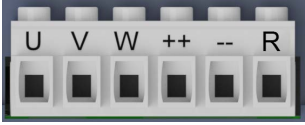
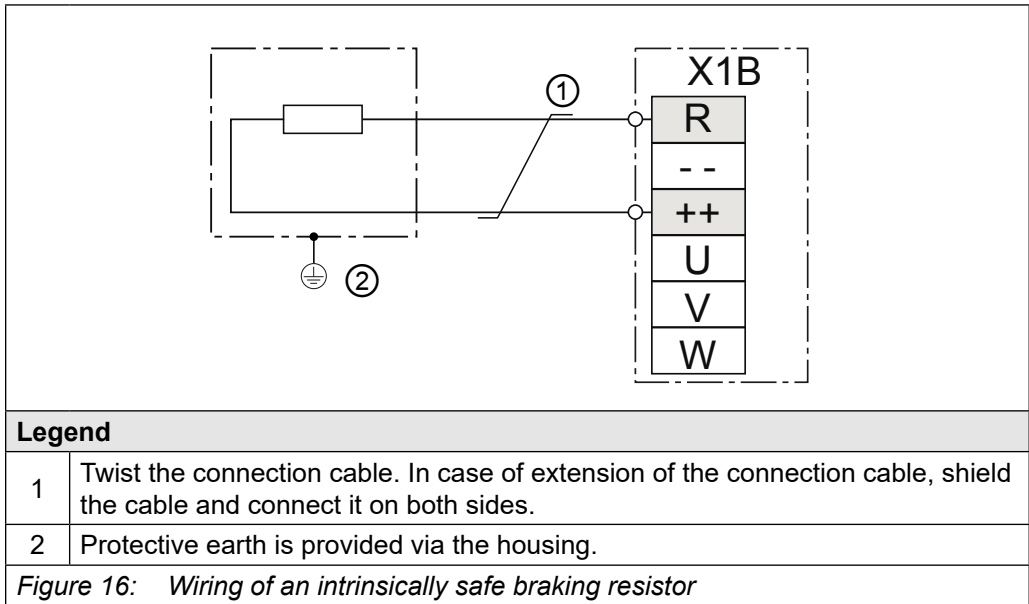
X1B	Name	Function	Cross-section		Tightening torque
			AWG without wire-end ferrule	mm <sup>2</sup> with wire-end ferrule	
	++, R	Connection for braking resistor	24...14	0.25...2.5	0.5...0.6A 5...6lb-inch
			stranded wire		

Figure 15: Terminal block X1B connection of a braking resistor



Terminal R can alternatively be labeled with PB.

4.2.6.2 Wiring of an intrinsically safe braking resistor



**NOTICE**

**Only intrinsically safe braking resistors permitted!**

Only "intrinsically safe" braking resistors are permissible for this operation, since these resistors interrupt themselves at fault such as safety fuse without fire risk.



Technical data and design for intrinsically safe braking resistors.  
[www.keb.de/fileadmin/media/Manuals/dr/ma\\_dr\\_safe-braking-resistors-20106652\\_en.pdf](http://www.keb.de/fileadmin/media/Manuals/dr/ma_dr_safe-braking-resistors-20106652_en.pdf)



4.2.6.3 Use of non-intrinsically safe braking resistors

**WARNING**



**Use of non-intrinsically safe braking resistors**

**Fire or smoke development in case of overload or fault!**

- ▶ Only use braking resistors with temperature sensor.
- ▶ Evaluate temperature sensor.
- ▶ Trigger fault on the drive controller (e.g. external input).
- ▶ Switch off input voltage (e.g. input contactor).
- ▶ Connection examples for non-intrinsically safe braking resistors => *Instructions for use „Installation Braking Resistors“*.



Instructions for use „Installation Braking Resistors“  
[www.keb.de/fileadmin/media/Manuals/dr/ma\\_dr\\_braking-resistors-20116737\\_en.pdf](http://www.keb.de/fileadmin/media/Manuals/dr/ma_dr_braking-resistors-20116737_en.pdf)



### 4.2.7 Connection of a temperature detection

#### 4.2.7.1 Temperature detection terminals T1, T2

The COMBIVERT G6 is delivered with a PTC evaluation. The function corresponds to [EN 60947-8](#) and works in accordance with the following table:

Function of T1, T2	Resistance	Display ru46	Error/warning
PTC or temperature switch	< 750 Ω	T1-T2 closed	–
	0.75...1.65 kΩ (reset resistance)	undefined	
	1.65...4 kΩ (tripping resistance)		
	> 4 kΩ	T1-T2 open	✓

Figure 17: Temperature detection terminals T1, T2



The behaviour of the drive controller in case of error/warning is defined with parameter CP37 (Pn12). At factory setting the switching condition "9: dOH warning" is set when terminals T1, T2 are open.

#### 4.2.7.2 Terminal block X1C temperature detection

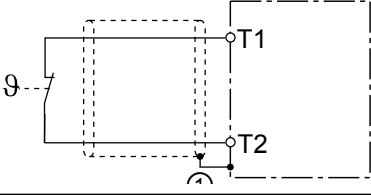
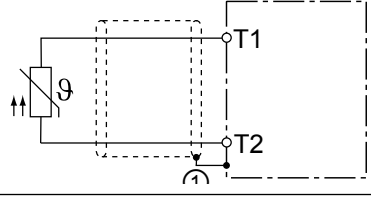
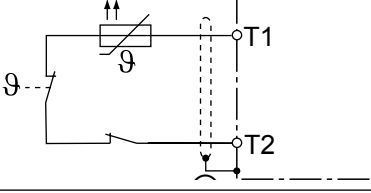
X1C	Name	Function	Cross-section		Tightening torque
			AWG without wire-end ferrule	mm <sup>2</sup> with wire-end ferrule	
	T1, T2	Connection for temperature sensor	30...14	0.25...1.5	0.22...0.25 Nm 2 lb inch
			stranded wire		

Figure 18: Terminal block X1C temperature detection

## CALCULATION OF THE MOTOR VOLTAGE

### 4.2.7.3 Use of the temperature detection

The temperature detection provides the user all possibilities within the resistance range specified in „4.2.7 Connection of a temperature detection“. This can be:

<p>Thermal contact (NC contact) e.g. at the brake resistor</p>	
<p>Temperature sensor (PTC) e.g. at motor temperature detection</p>	
<p>Mixed sensor chain</p>	
<p>Figure 19: Wiring examples of the temperature input</p>	

### 4.2.8 Final test information

Final test information of the machines/systems which are provided with drive converters according to [EN 60204-1](#) of 2007.

## 4.3 Calculation of the motor voltage

The motor voltage for dimensioning of the drive is depending on the used components. The mains voltage reduces according to the following table:

Components	%	Example
Mains choke Uk	4	Closed loop drive converter with mains and motor choke at non-rigid supply system: 400 V mains voltage - 15% = 340 V motor voltage
Drive converter open-loop	4	
Drive converter closed-loop	8	
Motor choke Uk	1	
Non-rigid supply system	2	
<p>Table 13: Calculation of the motor voltage</p>		

## 5 UL certification

### 5.1 CE-Marking

CE marked drive controllers are developed and manufactured to comply with the regulations of the Low-Voltage Directive 2006/95/EC and EMC directive (2004/108/EC). The harmonized standards of the series *EN 61800-5-1* and *EN 61800-3* were used.

### 5.2 Functional safety

Drive controllers with functional safety are marked with the FS logo on the nameplate. These units are designed and manufactured in accordance with the Machine Directive (2006/42/EC). The harmonized standard of the series *EN 61800-5-1* is used.

### 5.3 UL Marking

	Acceptance according to UL is marked at KEB drive controllers with the adjacent logo on the nameplate.
--	--

To be conform according to UL for use on the North American and Canadian Market the following additionally instructions must be observed (original text of the UL-File):

<ul style="list-style-type: none"> <li>• "Only for use in WYE 480V/277V supply sources"</li> </ul>
<ul style="list-style-type: none"> <li>• Operator and Control Board Rating of relays (30Vdc.:1A)</li> </ul>
<ul style="list-style-type: none"> <li>• "Maximum Surrounding Air Temperature 45°C"</li> </ul>
<ul style="list-style-type: none"> <li>• "Internal Overload Protection Operates prior to reaching the 200% of the Motor Full Load Current".</li> </ul>
<ul style="list-style-type: none"> <li>• For 480V rated models:                      "Suitable For Use On A Circuit Capable Of Delivering Not More Than 5000 rms Symmetrical Amperes, 480 Volts Maximum, see instruction manual for Branch Circuit Protection details"                      and                      "Suitable For Use On A Circuit Capable Of Delivering Not More Than 18000 rms Symmetrical Amperes, 480 Volts Maximum when protected by CC, J or RK5 Class Fuses", see instruction manual for maximum fuse sizes".                 </li> </ul>
<ul style="list-style-type: none"> <li>• For 240V rated models:                      „Suitable For Use On A Circuit Capable Of Delivering Not More Than 5000 rms Symmetrical Amperes, 240 Volts Maximum, see instruction manual for Branch Circuit Protection details“                      and                      „Suitable For Use On A Circuit Capable Of Delivering Not More Than 18000 rms Symmetrical Amperes, 240 Volts Maximum when protected by CC, J or RK5 Class Fuses“, see instruction manual for maximum fuse sizes“.                 </li> </ul>
<ul style="list-style-type: none"> <li>• "Integral solid state short circuit protection does not provide branch circuit protection. Branch circuit protection must be provided in accordance with the Manufacturer Instructions, National Electrical Code and any additional local codes".</li> </ul>
<p><i>continued on the next page</i></p>

•	Wiring terminals are marked to show a range of values or a nominal value of tightening torque in pound-inches to be applied to the clamping screws as shown below: Input/Output terminals: 5...7 lb-in (0.56...0.79Nm)
•	Use in a Pollution Degree 2 environment.
•	"Use 60/75°C Copper Conductors Only"
•	"During the UL evaluation, only Risk of Electrical Shock and Risk of Fire aspects were investigated. Functional Safety aspects were not evaluated"
•	In order to comply with CSA C22.2 No. 14-2010 (cUL) following external Input Chokes need to be installed: See table 1 below!

**Table 1: Mains input chokes for CSA applications:**

Cat. No.	Housing	Input Voltage [V]	Reactor Cat. No.	FLA	Inductance [mH]
07G6	A	240 / 1ph	07DRF08-2951	10A	2.93
09G6	A	240 / 1ph	09DRF08-1851	16A	1.83
07G6	A	480 / 3ph	07DRB08-4951	3 x 6A	4.88
09G6	A	480 / 3ph	10DRB08-3751	3 x 8A	3.66
10G6	A	480 / 3ph	10DRB08-3751	3 x 8A	3.66

Branch Circuit Protection for G6 - A Drive series

I) Fuses:

Cat. No.	Housing	Input Voltage [V]	Class CC, J or RK5 UL248 Fuse rating 600V [A]
07G6	A	240 / 1ph	15
09G6	A	240 / 1ph	20
07G6	A	480 / 3ph	6
09G6	A	480 / 3ph	10
10G6	A	480 / 3ph	10

The voltage rating of the external fuses shall be at least equal to the input voltage of the drives.

II) Listed (DIVQ, DIVQ7/CSA Certified ) Circuit Breakers, Type, manufacturer and electrical ratings as specified below:

Cat. No.	Housing	Type	Manufacturer	Ratings
07G6	A	5SJ4 318-8HG42 S203UP-K 15 FAZ D15/3-NA 1489 A3D 150	SIEMENS ABB Eaton Allen Bradley	480Y/277V, 15A
09G6	A	5SJ4 318-8HG42 S203UP-K 15 FAZ D15/3-NA 1489 A3D 150	SIEMENS ABB Eaton Allen Bradley	480Y/277V, 15A
10G6	A	5SJ4 318-8HG42 S203UP-K 15 FAZ D15/3-NA 1489 A3D 150	SIEMENS ABB Eaton Allen Bradley	480Y/277V, 15A

*continued on the next page*

III) Listed (NKJH, NKJH7/CSA Certified) Type E Self Protected Manual Motor Controllers, Type and manufacturer and electrical ratings as specified below:

Cat. No.	Housing	Self Protected Manual Motor Controller, Type	Manufacturer	Self Protected Manual Motor Controller, ratings	Dial setting [A]
07G6	A	PKZM0(1) 6.3-E	Eaton	480Y/277V, 3.0 Hp	6
09G6	A	PKZM0(1) 10-E	Eaton	480Y/277V, 7.5 Hp	10
10G6	A	PKZM0(1) 10-E	Eaton	480Y/277V, 7.5 Hp	10

## DC - Bus Circuit Protection for G6-A Drive Series:

Cat. No.	Housing	Input Voltage [VDC]	Class CC, J or RK5 UL248 Fuse rating 600V [A]
07G6	A		in preparation
09G6	A		in preparation
07G6	A	680	10
09G6	A	680	15
10G6	A	680	20

WARNING – The opening of the branch circuit protective device may be an indication that a fault current has been interrupted. To reduce the risk of fire or electrical shock, current-carrying parts and other components of the controller should be examined and replaced if damaged. If burnout of the current element of an overload relay occurs, the complete overload relay must be replaced.

CSA: For Canada:

“ATTENTION - LE DÉCLENCHEMENT DU DISPOSITIF DE PROTECTION DU CIRCUIT DE DÉRIVATION PEUT ÊTRE DÙ À UNE COUPURE QUI RÉSULTE D'UN COURANT DE DÉFAUT. POUR LIMITER LE RISQUE D'INCENDIE OU DE CHOC ÉLECTRIQUE, EXAMINER LES PIÈCES PORTEUSES DE COURANT ET LES AUTRES ÉLÉMENTS DU CONTRÔLEUR ET LES REMPLACER S'ILS SONT ENDOMMAGÉS. EN CAS DE GRILLAGE DE L'ÉLÉMENT TRAVERSÉ PAR LE COURANT DANS UN RELAIS DE SURCHARGE, LE RELAIS TOUT ENTIER DOIT ÊTRE REMPLACÉ.”

## 5.4 Further informations and documentation

You find supplementary manuals and instructions for the download under [www.keb.de/de/service/downloads](http://www.keb.de/de/service/downloads)

### General instructions

- EMC and safety instructions
- Manuals for additional control boards, safety modules, fieldbus modules, etc.

### Instruction and information for construction and development

- Input fuses in accordance with UL
- Programming manual for control and power unit
- Motor configurator to select the appropriate drive converter and to create downloads for parameterizing the drive converter

### Approvals and approbations

- Declaration of conformity CE
- TÜV certificate
- FS certification

### Others

- COMBIVIS, the software for comfortable parameterization of drive converters via PC (available per download)
- EPLAN drawings



## 6 Accessories

### 6.1 Mounting kit shield connection braket

A mounting kit is available for large surface of the shieldings of the connecting cables:

Material number	Name
B0G6T88-0001	Mounting kit shield connection braket

Table 14: Mounting kit shield connection braket for G6 housing A

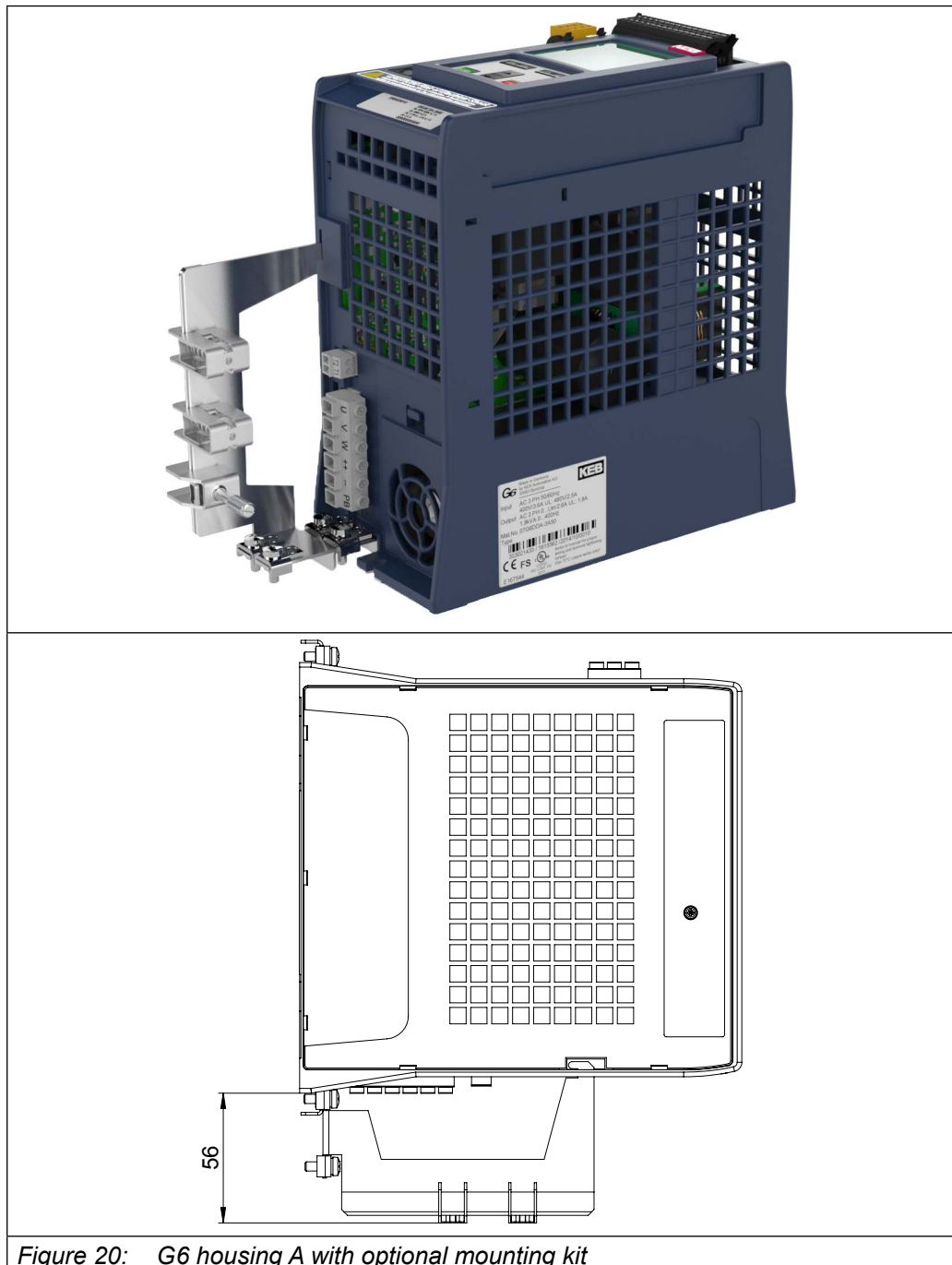


Figure 20: G6 housing A with optional mounting kit

## 7 Revision History

Revision	Date	Description
1B	2011-03	First published version
1C	2011-09	"Original manual" inserted; Type code extended; technical data changed; Connection braking resistor changed
1D	2012-02	recommended supply and motor cable cross-section removed; Drawings mains and motor connection changed; UL certification; Addresses on the rear side
1E	2012-07	Terminal description supplement
1F	2013-09	Completely revised; 230 V class included
1G	2014-04	Type code extended to VARAN: Technical data have been adapted; Voltages for DC operation; UL certification adapted
Version	Date	Description
00	2014-04	Changed to document number, revision 1G is identical to version 00
01	2018-03	Insertion of dimensions, conversion to new KEB corporate identity optics
02	2018-10	Editorial changes, warning symbol inserted
03	2019-05	Dimensions for mounting kit inserted
04	2020-03	Adjustments type code, editorial changes
05	2020-09	Editorial changes
06	2021-04	Insertion of the chapter "Leakage currents", editorial changes
07	2022-11	Correction part code

**Austria** | KEB Automation GmbH

Ritzstraße 8 4614 Marchtrenk Austria  
Tel: +43 7243 53586-0 Fax: +43 7243 53586-21  
E-Mail: info@keb.at Internet: www.keb.at

**Benelux** | KEB Automation KG

Dreef 4 - box 4 1703 Dilbeek Belgium  
Tel: +32 2 447 8580  
E-Mail: info.benelux@keb.de Internet: www.keb.de

**Brazil** | KEB South America - Regional Manager

Rua Dr. Omar Pacheco Souza Riberio, 70  
CEP 13569-430 Portal do Sol, São Carlos Brazil  
Tel: +55 16 31161294 E-Mail: roberto.arias@keb.de

**Czech Republic** | KEB Automation GmbH

Videnska 188/119d 61900 Brno Czech Republic  
Tel: +420 544 212 008  
E-Mail: info@keb.cz Internet: www.keb.cz

**France** | Société Française KEB SASU

Z.I. de la Croix St. Nicolas 14, rue Gustave Eiffel  
94510 La Queue en Brie France  
Tel: +33 149620101 Fax: +33 145767495  
E-Mail: info@keb.fr Internet: www.keb.fr

**Germany | Geared Motors**

KEB Antriebstechnik GmbH  
Wildbacher Straße 5 08289 Schneeberg Germany  
Telefon +49 3772 67-0 Telefax +49 3772 67-281  
Internet: www.keb-drive.de E-Mail: info@keb-drive.de

**Italy** | KEB Italia S.r.l. Unipersonale

Via Newton, 2 20019 Settimo Milanese (Milano) Italia  
Tel: +39 02 3353531 Fax: +39 02 33500790  
E-Mail: info@keb.it Internet: www.keb.it

**Japan** | KEB Japan Ltd.

15 - 16, 2 - Chome, Takanawa Minato-ku Tokyo 108 - 0074 Japan  
Tel: +81 33 445-8515 Fax: +81 33 445-8215  
E-Mail: info@keb.jp Internet: www.keb.jp

**P. R. China** | KEB Power Transmission Technology (Shanghai) Co. Ltd.

No. 435 QianPu Road Chedun Town Songjiang District  
201611 Shanghai P.R. China  
Tel: +86 21 37746688 Fax: +86 21 37746600  
E-Mail: info@keb.cn Internet: www.keb.cn

**Poland** | KEB Automation KG

Tel: +48 60407727  
E-Mail: roman.trinczek@keb.de Internet: www.keb.de

**Republic of Korea** | KEB Automation KG

Deoksan-Besttel 1132 ho Sangnam-ro 37  
Seongsan-gu Changwon-si Gyeongsangnam-do Republic of Korea  
Tel: +82 55 601 5505 Fax: +82 55 601 5506  
E-Mail: jaeok.kim@keb.de Internet: www.keb.de

**Spain** | KEB Automation KG

c / Mitjer, Nave 8 - Pol. Ind. LA MASIA  
08798 Sant Cugat Sesgarrigues (Barcelona) Spain  
Tel: +34 93 8970268 Fax: +34 93 8992035 E-Mail: vb.espana@keb.de

**Switzerland** | KEB Automation AG

Witzbergstrasse 24 8330 Pfaeffikon/ZH Switzerland  
Tel: +41 43 2886060 Fax: +41 43 2886088  
E-Mail: info@keb.ch Internet: www.keb.ch

**United Kingdom** | KEB (UK) Ltd.

5 Morris Close Park Farm Industrial Estate  
Wellingborough, Northants, NN8 6 XF United Kingdom  
Tel: +44 1933 402220 Fax: +44 1933 400724  
E-Mail: info@keb.co.uk Internet: www.keb.co.uk

**United States** | KEB America, Inc

5100 Valley Industrial Blvd. South  
Shakopee, MN 55379 United States  
Tel: +1 952 2241400 Fax: +1 952 2241499  
E-Mail: info@kebameric.com Internet: www.kebameric.com

**MORE KEB PARTNERS WORLDWIDE:**

... [www.keb.de/contact/contact-worldwide](http://www.keb.de/contact/contact-worldwide)



**Automation with Drive**

**[www.keb.de](http://www.keb.de)**

KEB Automation KG Suedstrasse 38 32683 Barntrup Tel. +49 5263 401-0 E-Mail: [info@keb.de](mailto:info@keb.de)