

DATENBLATT / DATA SHEET	Seite: 1/5
Typ: KEB-Filter 22E6T60-3100	REV: A



Allgemeine Beschreibung / General description

Filtertyp	Type of filter	Filter für / filter for f = 0,15 – 30 MHz
Leiteranzahl	Number of phases	3Ph + PE / Ground
Anschluss: Klemme (Anzugsmoment)	Connection: terminal (tightening torque)	35-95mm ² / AWG 4-AWG 4/0 (15Nm / 132,76 lb inch)
PE Verbindungen (Anzugsmoment)	Ground connections (tightening torque)	Bolzen M10 / stud M10 (max. 35Nm / 310 lb inch)

Elektrische Daten / Electrical data

Eingangsspannung <i>input voltage</i>	[V]	3 x 400/480 (U _{max} =550V)	
Nennfrequenz <i>rated frequency</i>	[Hz]	50 / 60 +/- 2	
maximale Umgebungstemperatur (T _{max}) <i>maximum ambient temperature(T_{max})</i>	[°C]	45	
Nennstrom (I _N bei T _{max}) <i>rated current (I_N at T_{max})</i>	[A]	150	
Verlustleistung (bei I _N) <i>power dissipation (at I_N)</i>	[W]	160	
Ableitstrom (im Betrieb / 50Hz) <i>Leakage current (normal condition / 50 Hz)</i>	[mA]	2,02	
max. Ableitstrom (eine Phase => PE) <i>max leakage current (one phase => PE)</i>	[mA]	Siehe Ableitstrom - Grafik <i>See grafic of leakage current</i>	
Gewicht <i>Weight</i>	[kg]	15	
DC- Widerstand <i>DC - resistance</i>	[Ohm]	0,001 (per phase)	
Prüfspannungen / HV – Test Voltage Phase -> Phase Phase -> PE	[V dc]	2100 2700	Zeit / Time 2 s 2 s
Klimakategorie (gem EN50178) <i>Categorie for Climate</i>		3K3	
Approbation <i>Approbation</i>		CE	
UL-Strom (I _{UL} bei T _{max} und U _{UL}) UL-curren (I _{UL} at T _{max} and U _{UL})	[A]	-	

EMV - Daten nach EN 61800-3 / datas for EMC based on EN 61800-3

Angaben beziehen sich auf die leitungs-
geführten Störungen am Netzeingang

Values are given for conducted disturbance
on AC - power input wiring

Schaltfrequenz / switchingfrequency	EN 61800-3	Motorleitung/motor cable
2-16kHz	C1 [B]	bis/up to 500 m

Berechnung Gesamtlänge:

$$\text{Gesamtlänge} = \sum_{l=1}^n \text{Motorleitungslängen} * \sqrt{n[\text{Anzahl der Motorleitungen}]}$$

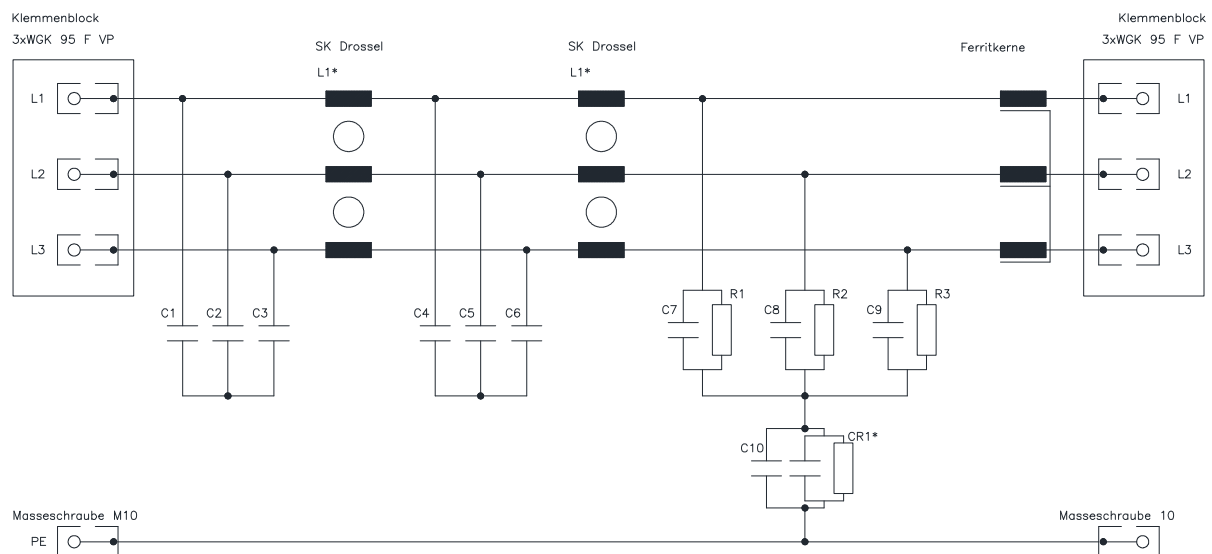
Prinzipschaltbild Filter / Schematics of filter



Mechanischer Aufbau (Prinzip) / Mechanical outline

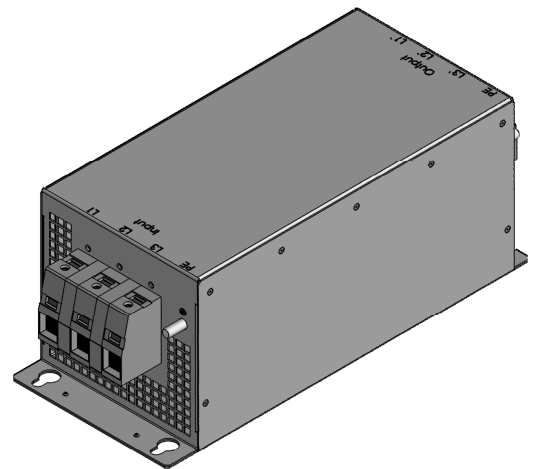
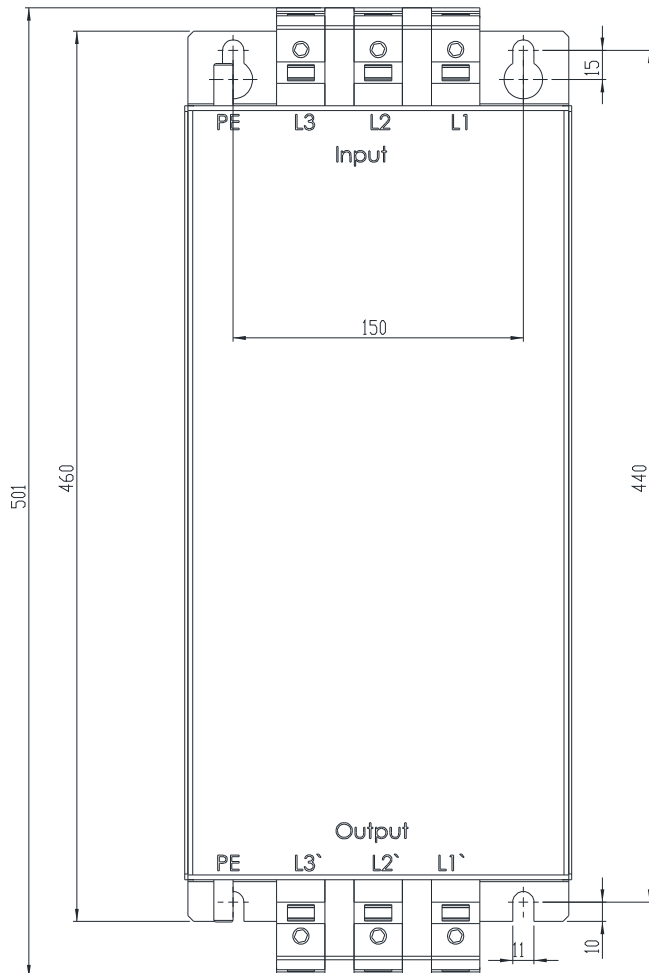
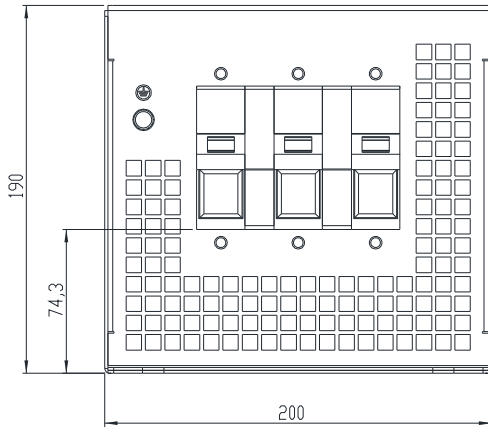



Meßprotokoll / Result of Measurement

Frequenzumrichter	<i>Inverter</i>	KEB: 18F5C1G-Y90A 16F5G1E-340A 15F5M1E-350A 13F5G1D-YQ1A 12F5G1D-3500 12F5G1D-YP00
Motor	<i>motor</i>	z.B. 3x5,5 kW und 3x2,2kW / 4 pol / 50 Hz (isoliert / isolated)
Motorleitungslänge	<i>Length of motor wiring</i>	Gesamtlänge 500 m
Motorkabeltyp	<i>Typ of cable</i>	Lapp ÖLFLEX 110 CY
Netznachbildung	<i>Artificial line</i>	Schwarzbeck, NSLK 8126
Messempfänger	<i>EMI - Receiver</i>	Rohde & Schwarz, ESPC 9kHz-1GHz
Grenzwertklasse	<i>Limit of disturbance</i>	C1 nach EN61800-3 (B nach EN55011) C1 of EN61800-3 (B of EN55011)
Messung der Störspannung	<i>Measurement of conducted voltage</i>	Phase => PE
Parameter: - Schaltfrequenz - Ausgangsfrequenz - Spannungsanhebung - Belastung	<i>Conditions</i> - <i>Switching frequency</i> - <i>Motor frequency</i> - <i>Boost</i> - <i>Load</i>	2 kHz 5 Hz 0 % 30 %

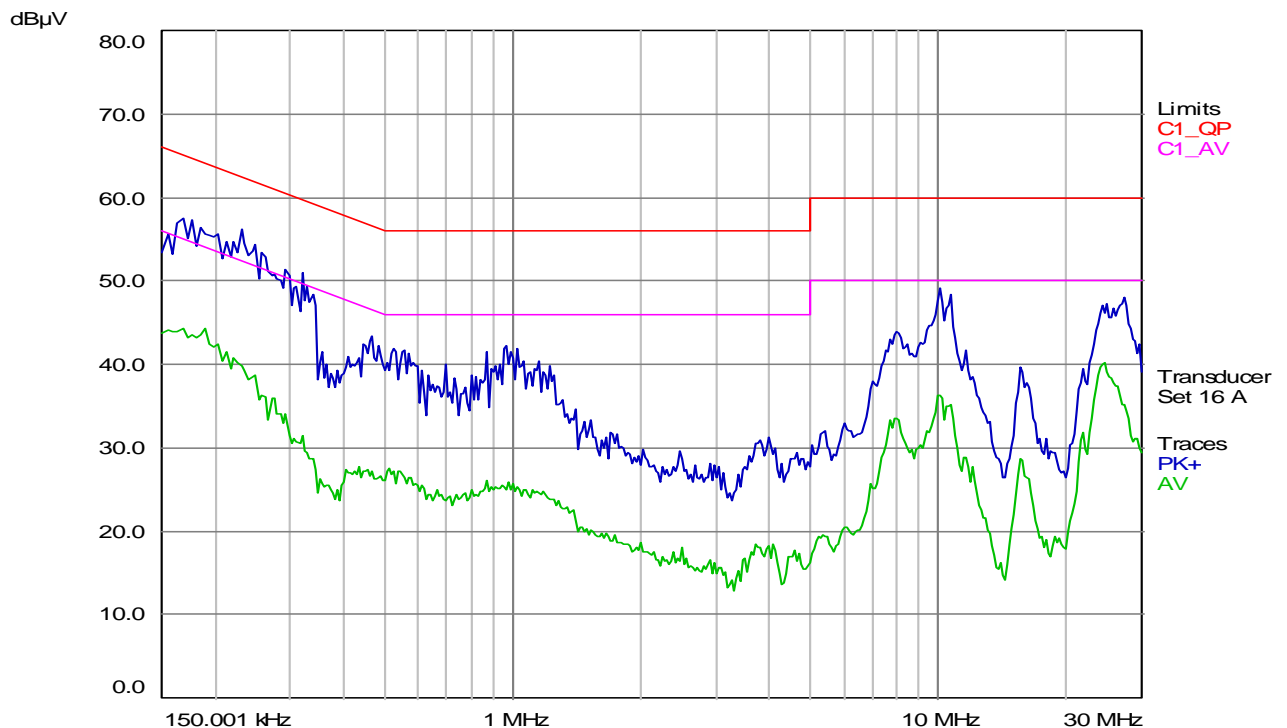



Ableitstrom bei 2kHz; 500m / Leakage current by 2kHz; 500m

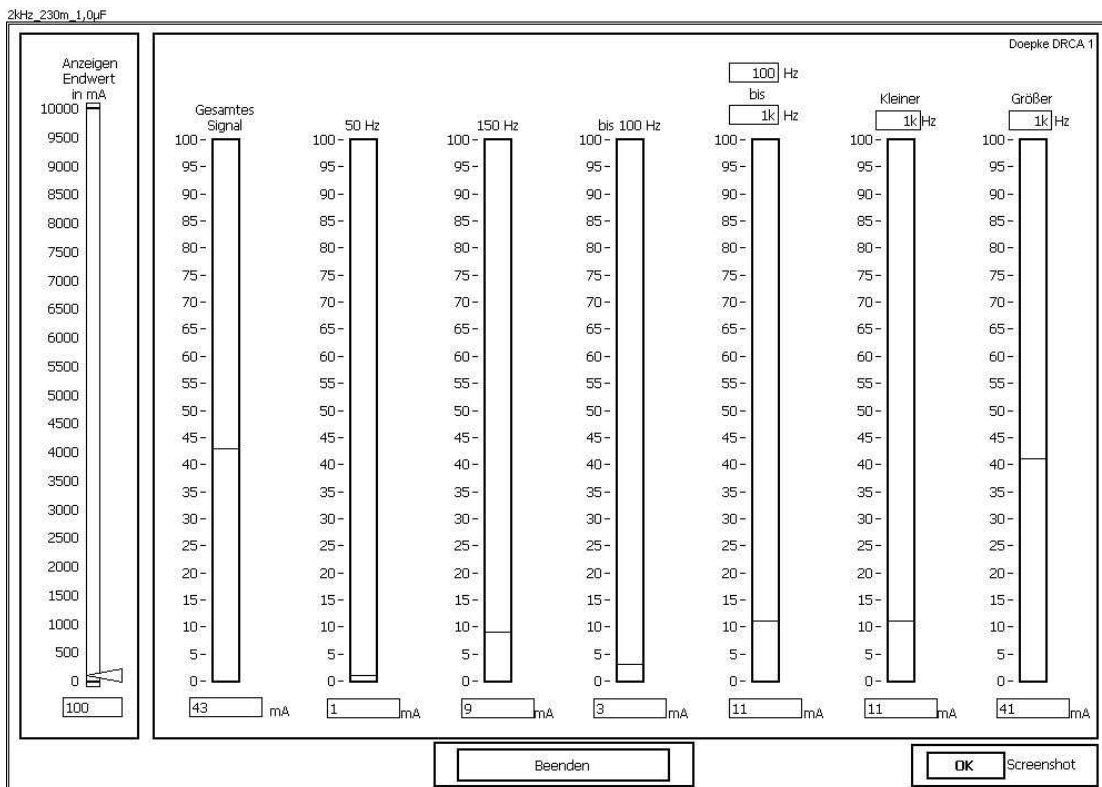
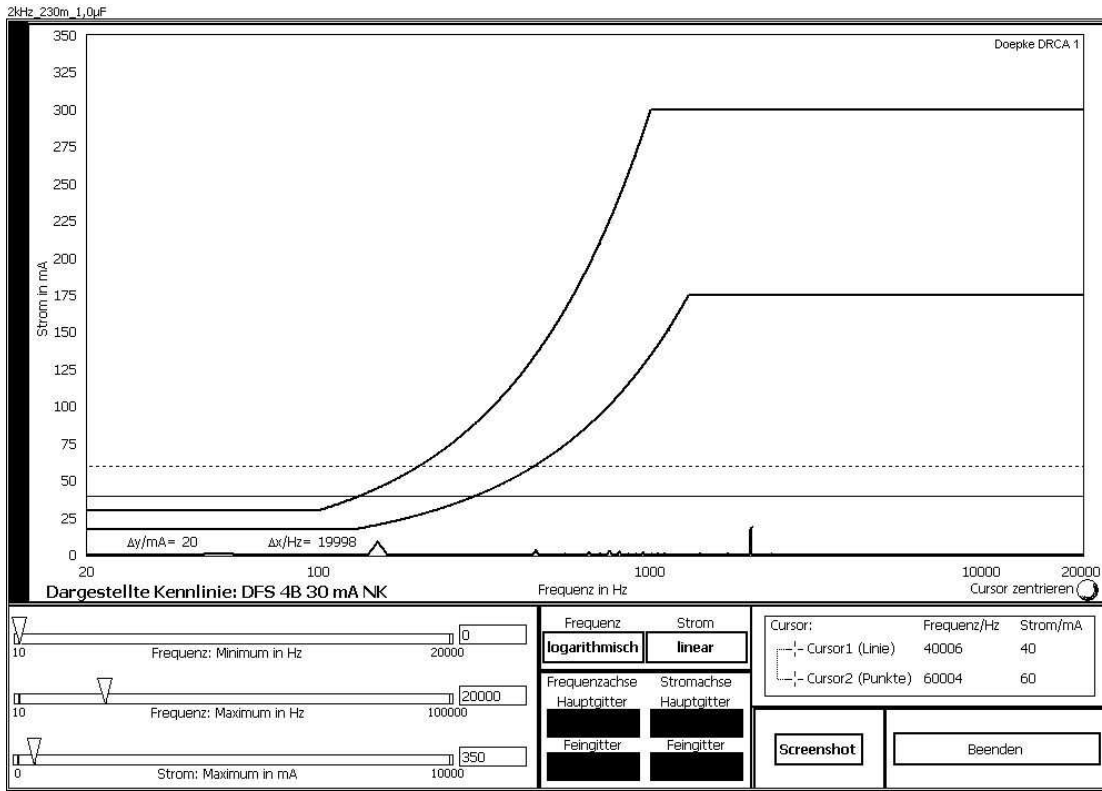

Erstellt:	Softic	Geprüft:	Erasmie	Freigegeben:	Softic
Datum:	31.08.12	Datum:	31.08.12	Datum:	31.08.12