



# COMBICONTROL C6

INSTRUCTION MANUAL | HMI / HMI LC

Translation of original manual  
Dokument 20125246 EN 02



## Table of Contents

<b>1</b>	<b>Introductory Information</b>	<b>5</b>
1.1	General notes	6
1.2	Trademarks	6
1.3	Instructions on disposal	6
1.4	Description of the safety symbols	7
1.5	Qualified personnel	8
1.6	Basic knowledge required	8
1.7	Proper use of the product	8
1.8	Purpose of the user's guide	8
1.9	The manual is a part of the system	8
1.10	Figures	8
1.11	Scope of the operating instructions	9
1.12	Safety instructions	9
1.12.1	Installation according to the instructions	9
1.12.2	Working on the control cabinet	9
1.13	Notes about usage	9
1.14	Applicable standard	9
<b>2</b>	<b>Description</b>	<b>10</b>
2.1	Product description	11
2.2	Key Features	11
2.3	Package	11
2.4	Configuration	12
2.4.1	C6 HMI/C6 HMI LC (full aluminium front panel)	12
2.5	Front view	12
2.5.1	Full aluminium front panel	12
2.5.2	Widescreen	13
2.6	Rear view	14
2.7	Side view	16
2.8	Connection overview C6 HMI 4.3"	18
2.8.1	Labels	18
2.9	Connection overview C6 HMI / C6 HMI LC 5.7" and higher	19
2.9.1	Connection Label	19
2.9.2	Nameplate	20
2.10	Touchscreen	20
2.11	Putting in operation C6 HMI / C6 HMI LC	21
2.11.1	Configuration and project creation	21
2.11.2	Process management	21
2.12	Software options	22
<b>3</b>	<b>Installation and connection</b>	<b>24</b>
3.1	Preparation for installation	25
3.1.1	Select the mounting location	25
3.1.2	Portrait Mounting	25
3.2	Checking the package contents	25
3.3	Checking the operating conditions	25
3.4	Mounting position	26
3.4.1	Damage due to overheating	26
3.5	Checking installation distances	27
3.6	Preparing the mounting cutout	27
3.6.1	Degrees of protection	28
3.6.2	Dimensions of the cutouts	28
3.7	Mounting the device	29
3.7.1	Position of the mounting clamps	29
3.7.2	Tools to tighten the mounting clamps	30
3.7.3	Procedure	31
3.8	Connecting the unit	34
3.8.1	Information for the connection	34
3.8.2	Power supply connection	34
3.8.3	Switching on and testing the device	35
3.9	Connecting the configuration PC	36
3.9.1	Procedure	39
<b>4</b>	<b>Commissioning the device</b>	<b>41</b>
4.1	Memory	42
4.2	Internal memory	42

4.3	Slot for memory card (from 5.7") .....	43
4.4	Installation/removal of a memory card .....	43
5	Commissioning a project .....	45
5.1	COMBIVIS studio HMI project .....	46
5.1.1	Overview .....	46
5.1.2	Transferring .....	46
5.1.3	Configuration the serial port .....	46
5.1.4	Connecting the serial port .....	48
5.1.5	Project administration .....	48
5.1.6	Stopping the running project .....	49
5.1.7	Starting the project .....	50
5.1.8	Debugging the project .....	51
5.1.9	Transfer the project from C6 HMI / C6 HMI LC to the configuration PC .....	53
5.1.10	Backup and restore .....	54
5.1.11	Update the operating system .....	54
5.2	COMBIVIS studio 6 project .....	55
5.2.1	C6 HMI LC – Implementation “CONTROL Runtime” .....	55
5.2.2	Preparing the COMBIVIS studio 6 programming environment .....	56
5.2.3	Transferring the COMBIVIS studio 6 application to the target system .....	57
5.2.4	I/O Feldbus .....	58
5.2.5	Support for retentive data .....	59
5.2.6	Use in combination with COMBIVIS HMI Runtime .....	61
5.2.7	Use in combination with COMBIVIS connect .....	63
5.2.8	Limitations and recommendations .....	63
6	System-Manager .....	64
6.1.1	Backup Restore .....	66
6.1.2	System clone und Restore .....	66
6.1.3	Font Antialiasing .....	69
6.1.4	EMMC Usage .....	70
6.1.5	Kiosk Mode .....	71
6.1.6	Language Settings .....	72
6.1.7	Scrollbar .....	73
6.1.8	System Reboot .....	73
6.1.9	Assign network settings via text file to USB stick .....	73
7	Maintenance .....	74
7.1	Calibration of the touchscreen .....	75
7.2	Maintenance & Cleaning .....	76
7.2.1	Procedure .....	77
7.2.2	Backup battery replacement (CR2032 3V) .....	77
7.3	Technical support & repairs .....	80
7.4	Recycling and disposal .....	80
8	Technical specifications .....	81
8.1	Technical specifications .....	82
8.1.1	4.3" Display characteristics .....	86
8.1.2	5.7" Display characteristics .....	86
8.1.3	7.0"W Display .....	86
8.1.4	8.4" Display characteristics .....	86
8.1.5	10.1"W Display characteristics .....	87
8.1.6	10.4" Display characteristics .....	87
8.1.7	12.1" (SVGA) display characteristics .....	87
	12.1"W display characteristics .....	88
8.1.8	15.0" Display characteristics .....	88
8.1.9	15.6"W Display characteristics .....	88
8.2	Certificates and approvals .....	89
8.3	Ports PINOUT .....	90
8.3.1	COM1 – DB15M Serial .....	90
8.3.2	LAN1 – LAN2 .....	90
8.3.3	USB1 / USB2 .....	90

SECTION **1**

**Introductory  
Information**







## 1.1 General notes

- a) The information in this manual is subject to change and is in no way binding upon KEB.
- b) KEB is not responsible for technical errors or other omissions in this manual and shall not accept any responsibility deriving from its use.

## 1.2 Trademarks

- a) All brands and product names mentioned in this manual are trademarks of their respective owners.

## 1.3 Instructions on disposal

- |    |   |
|----|---|
| DE | <p style="text-align: center;"></p> <ul style="list-style-type: none"> <li>• Das Symbol  auf dem Produkt oder seiner Verpackung weist darauf hin, dass dieses Produkt nicht als normaler Haushaltsabfall zu behandeln ist, sondern an einem Sammelpunkt für das Recycling von elektrischen und elektronischen Geräten abgegeben werden muss. Durch ihren Beitrag zum korrekten Entsorgen dieses Produkts schützen Sie die Umwelt und die Gesundheit Ihrer Mitmenschen. Umwelt und Gesundheit werden durch falsches Entsorgen gefährdet. Weitere Informationen über das Recycling dieses Produkts erhalten Sie von Ihrem Rathaus, Ihrer Müllabfuhr oder dem Händler, bei dem Sie das Produkt gekauft haben.</li> </ul>   |
| EN | <p style="text-align: center;"></p> <ul style="list-style-type: none"> <li>• The symbol  on the product or in its packaging indicates that this product may not be treated as household waste. Instead it shall be handed over to the applicable collection point for the recycling of electrical and electronic equipment. By ensuring this product is disposed of correctly, you will help prevent potential negative consequences for the environment and human health, which could otherwise be caused by inappropriate waste handling of this product. For more detailed information about recycling of this product, please contact your local city office, your household waste disposal service or the supplier where you purchased the product.</li> </ul> |
| FR | <p style="text-align: center;"></p> <ul style="list-style-type: none"> <li>• Le symbole  sur le produit ou son emballage indique que ce produit ne peut être traité comme déchet ménager. Il doit être remis au point de collecte dédié à cet effet (collecte et recyclage du matériel électrique et électronique). En procédant à la mise à la casse réglementaire de l'appareil, nous préservons l'environnement et notre sécurité, s'assurant ainsi que les déchets seront traités dans des conditions appropriées. Pour obtenir plus de détails sur le recyclage de ce produit, veuillez prendre contact avec les services de votre commune ou le distributeur où vous avez effectué l'achat.</li> </ul>  |

IT



- Il simbolo  sul prodotto o sulla confezione indica che il prodotto non deve essere considerato come un normale rifiuto domestico, ma deve essere portato nel punto di raccolta appropriato per il riciclaggio di apparecchiature elettriche ed elettroniche. Provvedendo a smaltire questo prodotto in modo appropriato, si contribuisce a evitare potenziali conseguenze negative per l'ambiente e la salute, che potrebbero derivare da uno smaltimento inadeguato del prodotto. Per informazioni più dettagliate sul riciclaggio di questo prodotto, contattare l'ufficio comunale, il servizio locale di smaltimento rifiuti o il fornitore da cui è stato acquistato il prodotto.

ES





- El símbolo  en el producto o en su embalaje indica que este producto no se puede tratar como desperdicios normales del hogar. Este producto se debe entregar al punto de recolección de equipos eléctricos y electrónicos para reciclaje. Al asegurarse de que este producto se desecha correctamente, usted ayudará a evitar posibles consecuencias negativas para el ambiente y la salud pública, lo cual podría ocurrir si este producto no se manipula de forma adecuada. Para obtener información más detallada sobre el reciclaje de este producto, póngase en contacto con la Administración de su ciudad, con su servicio de desechos del hogar o con el surtidor donde compró el producto.

PT



- Símbolo  no produto ou na embalagem indica que este produto não pode ser tratado como lixo doméstico. Em vez disso, deve ser entregueado ao centro de recolha selectiva para a reciclagem de equipamento eléctrico e electrónico. Ao garantir uma eliminação adequada deste produto, irá ajudar a evitar eventuais consequências negativas para o meio ambiente e para a saúde pública, que, de outra forma, poderiam ser provocadas por um tratamento incorrecto do produto. Para obter informações mais detalhadas sobre a reciclagem deste produto, contacte os serviços municipalizados locais, o centro de recolha selectiva da sua área de residência ou o distribuidor onde adquirir o produto.

## 1.4 Description of the safety symbols

 Danger	This symbol indicates a danger to life or health of personnel.
 Attention	This symbol indicates a danger to the hardware and / or the environment.
 Note	This symbol refers to additional information for a better understanding.

## 1.5 Qualified personnel

- a) C6 HMI / C6 HMI LC may be operated only by personnel qualified for the specific task in accordance with the relevant documentation for the specific task, in particular its warning notices and safety instructions.
- b) Qualified personnel are those who, based on their training and experience, are able to identify risks and avoid potential hazards when working with these systems.

## 1.6 Basic knowledge required

- a) To understand operating instructions a general knowledge of automation technology is needed.
- b) Knowledge of personal computers and the Microsoft operating system is required to understand this operating instruction.

## 1.7 Proper use of the product

- a) KEB products may only be used for the applications described in the catalogue and in the technical documentation.
- b) If products and components from other manufacturers are used, these must be approved by KEB.
- c) Proper transport, assembly, installation, storage, commissioning, operation and maintenance are required to ensure that the product operates safely.
- d) The indicated environmental conditions must be observed.
- e) The information in this user's manual must be observed.

## 1.8 Purpose of the user's guide

- a) This user's manual contains information based on the requirements defined by DIN EN 62079 for mechanical engineering documentation.
- b) These operating instructions are intended for:
  - 1. Users
  - 2. Commissioning engineers
  - 3. Maintenance personnel
- c) Pay attention to the information in the chapter "Safety instructions".
- d) More information such as operating instructions, examples and reference information, are available in the online help of COMBIVIS studio HMI and COMBIVIS connect.

## 1.9 The manual is a part of the system

- a) This user's guide belongs to C6 HMI / C6 HMI LC and is also required for commissioning.
- b) Keep all supplied documentation for the entire service life of C6 HMI / C6 HMI LC.

## 1.10 Figures

- a) This manual contains illustrations of the described devices.
- b) Some details of the illustrations may differ from the device provided.



## 1.11 Scope of the operating instructions

The operating instructions apply to the C6 HMI / C6 HMI LC family devices in conjunction with the COMBIVIS studio HMI software. The devices are the following:

C6 HMI	4.3"	Full aluminum front panel
	5.7"	
	7.0" W	
	8.4"	
	10.1" W	
	10.4"	
	12.1"	
	12.1" W	
	15.0"	
	15.6" W	
C6 HMI LC	5.7"	Full aluminum front panel
	7.0" W	
	8.4"	
	10.1" W	
	10.4"	
	12.1"	
	12.1" W	
	15.0"	
15.6" W		

## 1.12 Safety instructions

### 1.12.1 Installation according to the instructions

- Commissioning the device is prohibited until it has been absolutely ensured that the system in which the device is to be installed complies with all the applicable EU and international regulation.

### 1.12.2 Working on the control cabinet

- **Open equipment**  
The device is open equipment. This means, the C6 HMI / C6 HMI LC may only be installed in housings or cabinets that can be operated from the front. Access to the cabinet in which the C6 HMI / C6 HMI LC is installed may only be done with a key or tool by trained and authorized personnel.
- **Dangerous voltage**  
High voltage parts can be exposed by opening the cabinet. Before opening the cabinet always disconnect the power.

## 1.13 Notes about usage

- C6 HMI / C6 HMI LC is approved for indoor use only.
- C6 HMI / C6 HMI LC may be damaged if operated outdoors.

## 1.14 Applicable standard

Please refer to section 8 for details about the relevant standards.

SECTION **2**  
**Description**

---

## 2.1 Product description

The C6 HMI family is the HMI solution with RISC architecture that allows running COMBIVIS studio HMI and COMBIVIS studio 6 connect software platforms.

The C6 HMI LC family is the HMI & Control solution that integrates the COMBIVIS studio HMI visualization software and the CONTROL Basic Runtime integrating in one single product both the visualization and the process control part.

Based on ARM Cortex A8 processor and Microsoft Windows Embedded Compact 7 (C7P) operating system, C6 HMI/C6 HMI LC are available in BASIC or ADVANCED version according to COMBIVIS studio HMI runtime installed. The CONTROL Runtime license "BASIC" is of one unique type and enables all the features at ones except for the CONTROL PRO Runtime which is not supported.

## 2.2 Key Features

Key Features	C6 HMI	C6 HMI LC
O.S. Microsoft Windows Embedded Compact 7 (C7P) installed on flash memory.	X	X
KEB COMBIVIS studio HMI Runtime	X	X
KEB COMBIVIS connect Runtime	X	X
CONTROL Runtime V3.x CONTROL PRO Runtime NOT supported	-	X
CPU ARM CORTEX A8 architecture	X	X
Multiple mass memories support: <ul style="list-style-type: none"> <li>• NAND: write security memory used to store O.S. and HMI executables</li> <li>• eMMC: fast access memory used for some applications (e.g. CONTROL Runtime) and user data</li> <li>• SD (socket): removable memory</li> </ul>	X	X
Frontal IP 66	X	X
Micro UPS	X	X

## 2.3 Package

C6 HMI / C6 HMI LC package consists of:





C6 HMI / C6 HMI LC system	
Quick Installation guide	
n.10 Clamps with grub screw (depending on the LCD size)	
n.1 hex key 1.5mm	
n.1 Power supply plug	

Table 1  
Packaging

## 2.4 Configuration

The following figures show the various configurations.

### 2.4.1 C6 HMI/C6 HMI LC (full aluminium front panel)

Figure 1  
C6 HMI / C6 HMI LC 5.7"

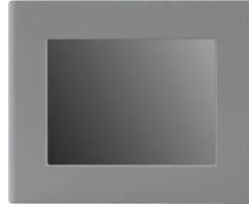

C6 HMI	4.3"	Full aluminium front panel
	5.7"	
	7.0"W	
	8.4"	
	10.1" W	
	10.4"	
	12.1"	
	12.1" W	
	15.0"	
15.6" W		

C6 HMI LC	5.7"	Full aluminium front panel
	7.0" W	
	8.4"	
	10.1" W	
	10.4"	
	12.1"	
	12.1" W	
	15.0"	
	15.6" W	

## 2.5 Front view

### 2.5.1 Full aluminium front panel

Figure 2  
Aluminium front panel details



- ① Full aluminium front panel
- ② Touchscreen display

## 2.5.2 Widescreen

In the C6 HMI / C6 HMI LC family the systems with 5.7", 8.4", 10.4", 12.1", 15.0" display have a 4:3 aspect ratio, whereas the systems with 4.3", 7.0"W, 10.1"W, 12.1"W and 15.6"W display have a aspect ratio of 15:9 or 16:9.

The 7.0" display provides 25% more surface than the smaller 5.7" size.

### 2.5.2.1 Widescreen full aluminium front panel

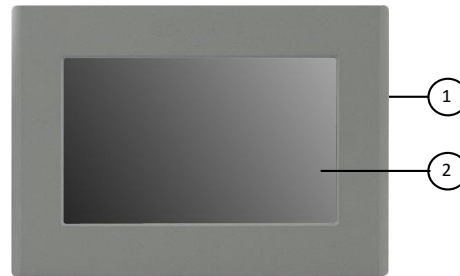
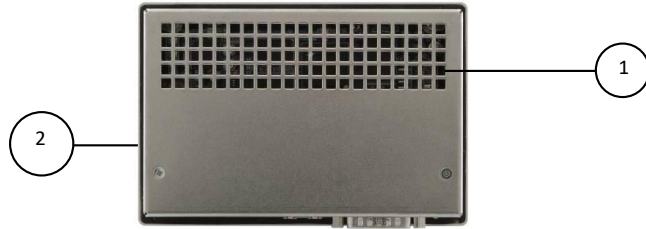

Figure 3  
Aluminium front panel details

- ① Frame
- ② Touchscreen display

## 2.6 Rear view

Figure 4  
C6 HMI 4.3" rear view



- 1 Ventilation holes
- 2 Mounting seal

Figure 5  
C6 HMI / C6 HMI LC 5.7" rear view

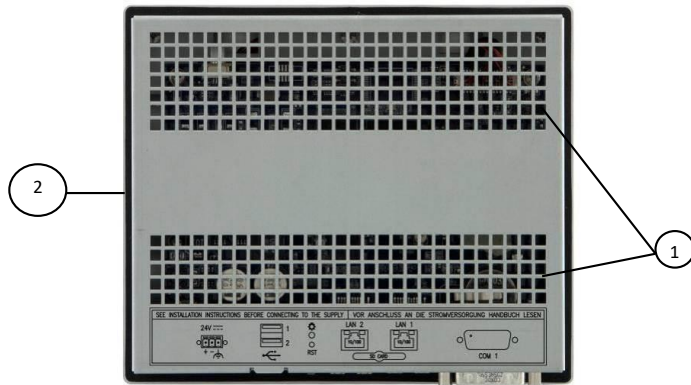

- 1 Ventilation holes
- 2 Mounting seal

 Note: rear panels may be different depending on display size.

Figure 6  
C6 HMI / C6 HMI LC 7.0" rear view



- 1 Ventilation holes
- 2 Mounting seal

 Note: the user manual refers to HMI 5.7" version. Other versions will be discussed only when necessary.

Figure 7  
C6 HMI / C6 HMILC 8.4" rear view



- ① Aeration holes
- ② Mounting seal

## 2.7 Side view

Figure 8  
C6 HMI 4.3" side view



- ① Aeration holes

Figure 9  
C6 HMI 4.3" side view



- ① Aeration holes
- ② Recess for fixing clamps

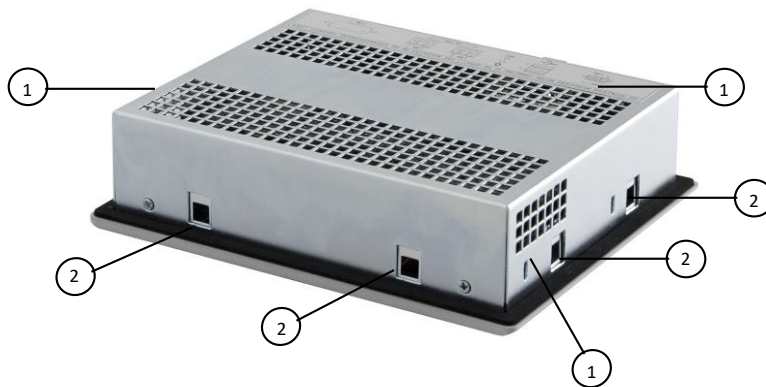

Figure 10  
C6 HMI / C6 HMI LC 5.7" side view



- ① Aeration holes
- ② Recess for fixing clamps

Figure 11  
C6 HMI / C6 HMI LC 5.7" side view



- ① Aeration holes
- ② Recess for fixing clamps

## 2.8 Connection overview C6 HMI 4.3"

Figure 12  
C6 HMI 4.3" connections

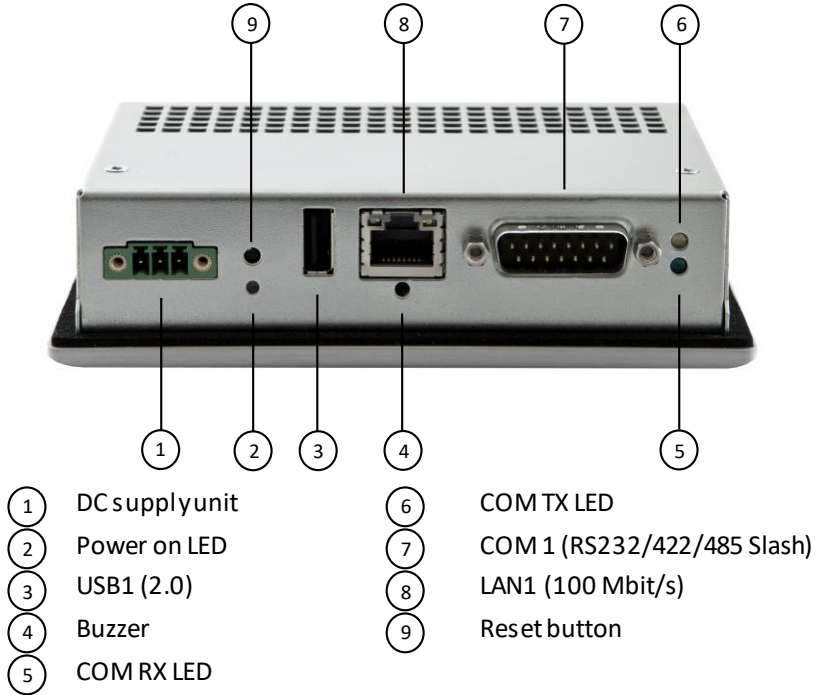

### 2.8.1 Labels

On the rear panel are present the following the connectors label.

Figure 13  
C6 HMI / C6 HMI LC Labelling of the labels

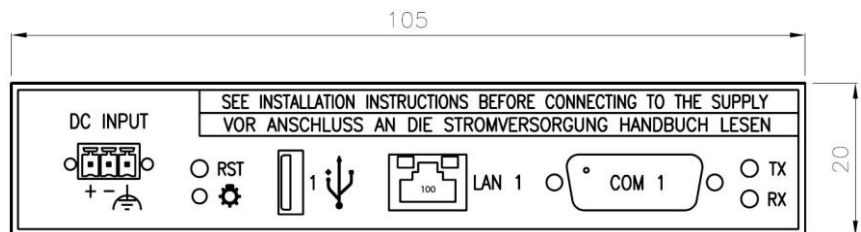

## 2.9 Connection overview C6 HMI / C6 HMI LC 5.7” and higher

Figure 14  
C6 HMI / C6 HMI LC 5.7” connectors

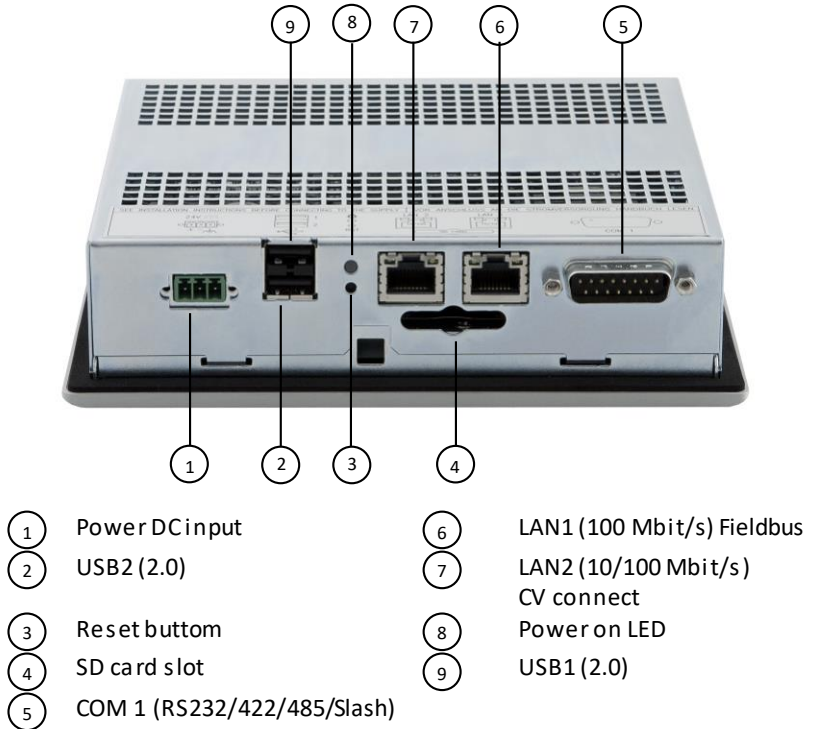

### 2.9.1 Connection Label

On the rear panel are present the following the connectors label.

Figure 15  
C6 HMI / C6 HMI LC Labelling of the labels

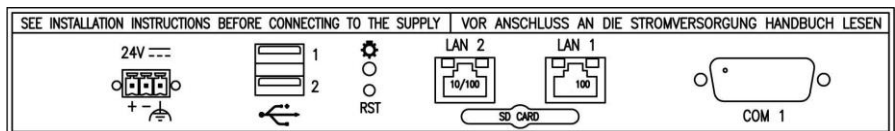

### 2.9.2 Nameplate

Figure 16  
C6 HMI / C6 HMI LC nameplate details

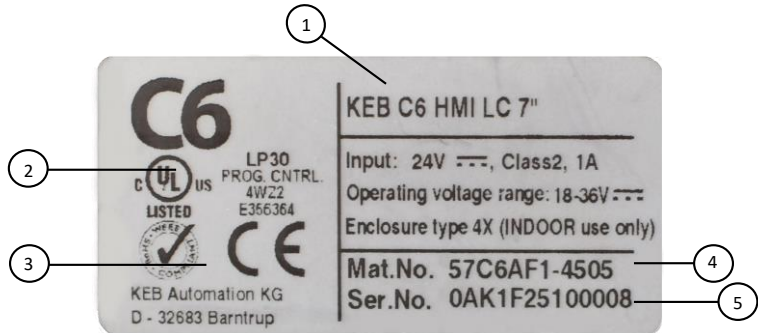

- ① Model
- ② UL-Marking
- ③ CE-Marking
- ④ Material number
- ⑤ Serial number

### 2.10 Touchscreen

Table 2  
Touchscreen

	Size	Touchscreen	Panel technology
Standard	4.3"	4-wire	The touchscreen is installed from the back of the front panel. There is a step between the front panel and the touchscreen. The user touches directly the touchscreen.
	5.7"		
	7.0" W		
	8.4"	5-wire	
	10.1" W		
	10.4"		
	12.1"		
	12.1" W		
	15.0"		
15.6" W			

## 2.11 Putting in operation C6 HMI / C6 HMI LC

To put in operation C6 HMI / C6 HMI LC the followings two phases must be done:

- Configuration and creation of the project of C6 HMI / C6 HMI LC.
- Process management.

### 2.11.1 Configuration and project creation

During the configuration phase, you create the user interfaces for operation and monitoring of the technical process by using a PC on which is installed COMBIVIS studio HMI development environment. Configuration also includes:

- Creating the project.
- Saving the project.
- Testing the project.
- Simulating the project.

After compiling the configuration, you load the project into the C6 HMI / C6 HMI LC device.

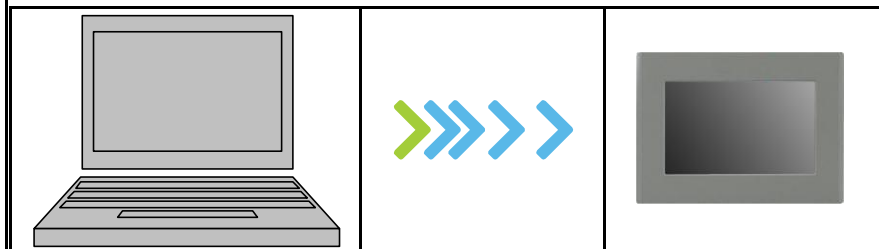

Figure 17  
Configuration and project creation

### 2.11.2 Process management

Process management is a two-way communication between HMI device and PLC.

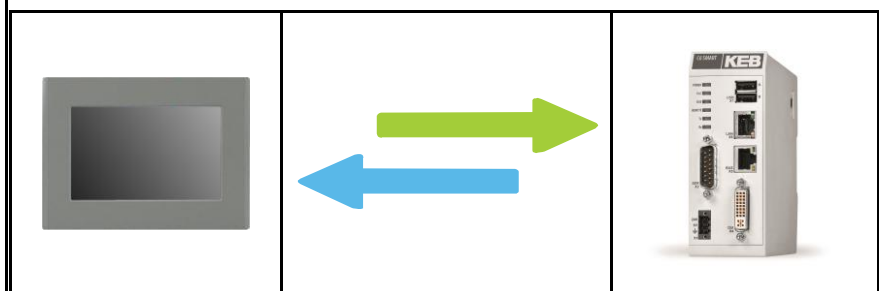

Figure 18  
Process management

## 2.12 Software options

Table 3  
Software options

Function	COMBIVIS studio HMI BASIC for Win CE	COMBIVIS studio HMI ADVANCED for Win CE
<b>RealTime DB</b>	Max. 1024 Byte	Max. 4096 Byte
Scaling	Yes	Yes
ODBC Realtime	Yes	Yes
Trace DB	Yes	Yes
Data structure	Yes	Yes
OPC client DA	Yes	Yes
Networking	Yes	Yes

Table 4  
Graphic interface

<b>Graphic interface</b>		
Vectorial graphic editor	Yes	Yes
Support for BMP, GIF, JPG, WMF, EMF	Yes	Yes
Dynamic animation	Yes	Yes
Symbols library	Yes	Yes
Import/Export symbols	Yes	Yes
Public symbols	Yes	Yes
Power templates (VBA symbols)	Yes	Yes
Grid	Yes	Yes
Synapsis	Yes	Yes
Scheduler	Yes	Yes
Editing menu	Yes	Yes
Style source management in symbols	Yes	Yes
IP camera viewer	Yes	Yes
Alias management in objects	Yes	Yes

Table 5  
Alarm log

<b>Alarm logs</b>	Max. 512 alarms	Max. 2048 alarms
Alarms management	Yes	Yes
Historical management (XML)	Yes	Yes
Historical management (ODBC)	Yes	Yes
Alarms notification (SMS, e-mail, voice)	No	Yes
Alarms area	Yes	Yes
Comments on alarm ACK	Yes	Yes

Table 6  
Recipes – Data loggers

<b>Recipes – Data Loggers</b>		
Recipes / Data Logger (XML)	Yes	Yes
Recipes / Data Loggers (ODBC)	Max. 2	Yes
Textual report	Yes	Yes

Table 7  
Trends

<b>Trends</b>		
Trend RealTime	Yes	Yes
Historical trends on file.CSV	Yes	Yes
Historical trends (linked to DataLogger XML)	Yes	Yes
Historical trends database (ODBC)	Yes	Yes
Data analysis	Yes	Yes

Table 8  
Users & passwords

<b>Users &amp; passwords</b>		
Use 1024 levels	Yes	Yes
User groups	Yes	Yes
CFR21	Yes	Yes
Runtime users	Yes	Yes

Table 9 Dynamic multilanguage	<b>Dynamic multilanguage</b>	Yes	Yes
	Unicode support	Yes	Yes
Table 10 Drivers	<b>Drivers</b>		
	Max. number of driver	2	4
	PLC tag importer	Yes	Yes
Table 11 Event object	<b>Event object</b>	Yes	Yes
Table 12 Scaling object	<b>Scaling object</b>	Yes	Yes
Table 13 Scheduler object	<b>Scheduler object</b>	Yes	Yes
Table 14 Logics	<b>Logics</b>		
	IL Logic (Step5-Step7)	Yes	Yes
	VBA Logic (WinWrap Basic)	Yes	Yes
	Sinapsis logic	Yes	Yes
Table 15 Networking	<b>Networking</b>	Yes	Yes
Table 16 Child Projects	<b>Child projects</b>	Yes	Yes
Table 17 Software options	<b>Screen navigation</b>	Yes	Yes
Table 18 Visual studio source safe 2005 integration	<b>Visual Studio SourceSafe 2005 Integration</b>	Yes	Yes
Table 19 Web server	<b>Webserver</b>	No	Yes
Table 20 Touchscreen support	<b>Touchscreen support</b>	Yes	Yes
Table 21 Cross reference	<b>Cross reference</b>	Yes	Yes
Table 22 Debugger	<b>Debugger</b>	Yes	Yes

SECTION **3**  
**Installation and  
connection**

---



## 3.1 Preparation for installation

### 3.1.1 Select the mounting location

Points to observe when selecting the mounting location:

- a) Position C6 HMI / C6 HMI LC to avoid exposure to direct sunlight.
- b) Position C6 HMI / C6 HMI LCs such that it is ergonomically accessible for the operator.
- c) Choose a suitable mounting height.
- d) Ensure that the ventilation holes are not covered.

### 3.1.2 Portrait Mounting

- C6 HMI / C6 HMI LC can be mounted in portrait mode; the display can be rotated according to the mounting position using the dedicated utility from the panel control panel.
- From the Start menu, select "Settings" and then "Control Panel"; the display rotation utility is available from "Freescale Display Driver".
- Double click on the icon to get the window from where you can select the desired orientation.
- The selection is immediately applied and does not require to be saved in the registry.



Note:

See section 2.3 Package.

## 3.2 Checking the package contents

- Check the package content for visible signs of transport damage and for completeness.
- In the case of damaged parts, contact your KEB representative. Do not install parts damaged during shipment.

## 3.3 Checking the operating conditions

- Read carefully the standards, approvals, EMC parameters and technical specifications for operation of the HMI device. This information is available in the following sections:
  - Certificates and approvals
  - Electromagnetic compatibility
- Check the mechanical and climatic ambient conditions for operation of the HMI device: Ambient conditions.
- Follow the instructions for local use of the HMI device: Notes about usage.
- Adhere to the permissible rated voltage and the associated tolerance range:
  - 24V
  - Range: 18...36 V<sub>DC</sub>

### 3.4 Mounting position

The HMI device is suitable for installation in:

- Mounting cabinets
- Control cabinets
- Switchboards
- Consoles

#### 3.4.1 Damage due to overheating

- The operative temperature must be between 0° and 50°C.
- All HMI systems are designed for vertical mounting position.
- An inclined installation reduces the thermal convection by the HMI device and the maximum permissible ambient temperature for operation. Please contact KEB for details.
- The HMI device may otherwise be damaged and its certifications and warranty will be void.



Note: For installation in control cabinets and in particular, in closed containers, make sure the recommended ambient temperature is maintained. For further details please refer to the chapter Technical Specifications.



Figure 19  
Mounting position

### 3.5 Checking installation distances

To ensure adequate ventilation it is necessary leaving the following open spaces around the system:

- X direction: (min.) 15 mm for each side.
- Y direction: (min.) 50 mm for each side.
- Z direction: (min.) 10 mm.

Figure 20  
Installation distances

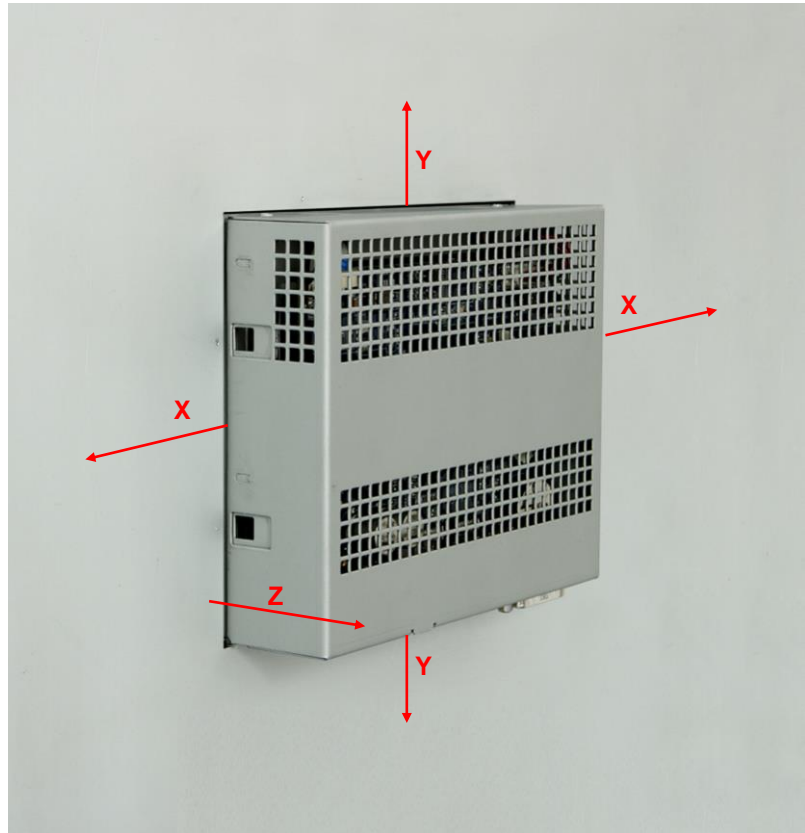

### 3.6 Preparing the mounting cutout

In order to ensure a proper mounting of the system, the material of the mounting cutout must be sufficiently stable.

To obtain the degree of protection described below, the material of the mounting panel must not deform due to the use of clamps on the operator panel.

### 3.6.1 Degrees of protection

The degrees of protection of the system are guaranteed only if the following conditions are satisfied:

- Material thickness at the mounting cutout for IP66 protection: 2 mm to 4 mm.
- Deviations of the plane of the mounting cutout limits:  $\leq 0.5$  mm.  
This condition must also be met with installed C6 HMI / C6 HMI LC.
- Allowed surface roughness in the area of the seal:  $\leq 120$  microns (Rz 120).

### 3.6.2 Dimensions of the cutouts

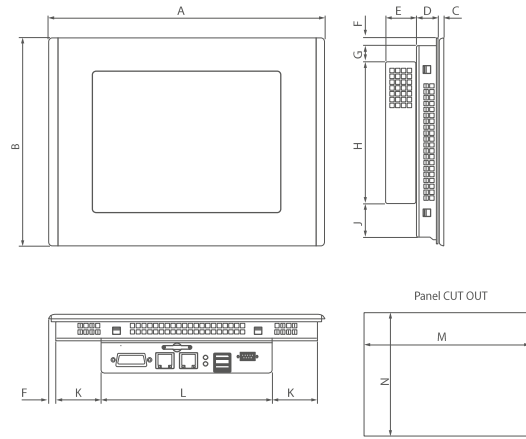









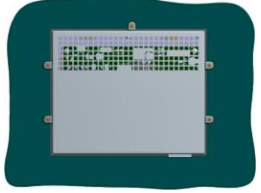

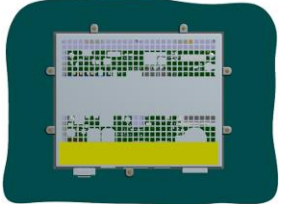

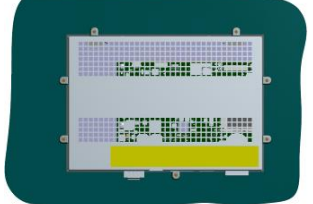

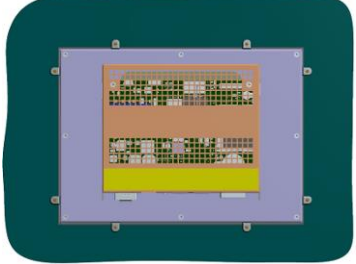

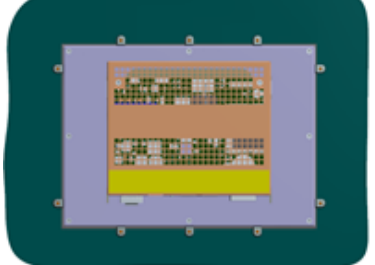

LCD TFT	A	B	C	D	E	F	G	H	I	K	L	M	N	Weight (kg)
4.3"	140	95	5	30	-	5	-	84	-	-	128	131	86	0.7
5.7"	175	145	5	40	-	7	-	131	-	-	161	164	134	0.9
7.0" W	215	155	5	40	-	7	-	141	-	-	201	204	144	1.2
8.4"	255	190	5	19.5	29	7.5	15	130	30	42	156	243	179	1.4
10.1" W	293	201.5	5	19.5	29	6.5	15	130	43.5	62	156	285	193.5	1.6
10.4"	295	230	5	19.5	29	7.5	15	130	70	62	156	283	219	1.8
12.1"	325	260	5	19.5	29	7.5	15	130	100	77	156	313	249	2.1
12.1" W	321	222.5	5	19.5	29	6.3	15	130	65	76	156	313	215	2.0
15.0"	390	305	6	19.5	29	7.5	15	130	145	109.5	156	378	294	3.3
15.6" W	420	265	6	19.5	29	7.5	15	130	105	124.5	156	410	255	3.3

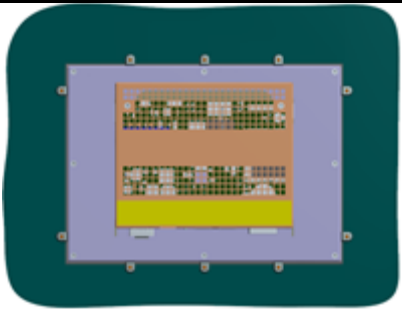
## 3.7 Mounting the device

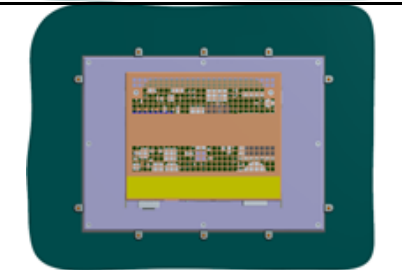
### 3.7.1 Position of the mounting clamps

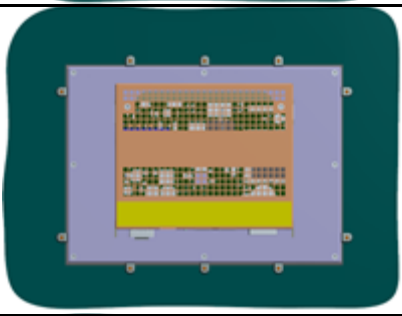
- To obtain the dedared degree of frontal protection for the system, it is necessary to respect the positions of the clamps shown below.
- The table below shows the number and the position of the clamps for each C6 HMI / C6 HMI LC size.

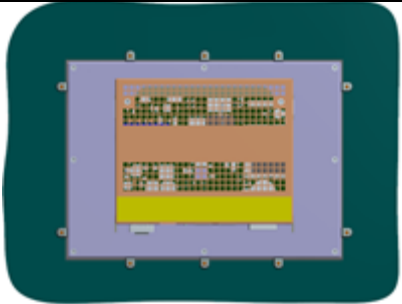
System	Clamp	Nujmber	Clamp position
C6 HMI / 4.3"		5	
C6 HMI / C6 HMI LC / 5.7"		7	
C6 HMI / C6 HMI LC / 7.0" W		7	
C6 HMI / C6 HMI LC / 8.4"		8	
C6 HMI / C6 HMI LC / 10.1" W		10	

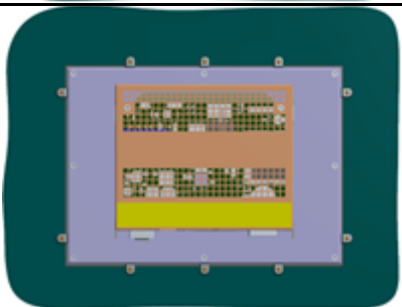
C6 HMI / C6 HMI LC / 10.4"		10	
C6 HMI / C6 HMI LC / 12.1"		10	
C6 HMI / C6 HMI LC / 12.1" W		10	
C6 HMI / C6 HMI LC / 15.0"		10	
C6 HMI / C6 HMI LC / 15.6" W		10	

### 3.7.2 Tools to tighten the mounting clamps

- 1.5 mm hexagonal key.

### 3.7.3 Procedure

1. Insert C6 HMI / C6 HMI LCi into the mounting cutout from the front.

*Figure 21  
Installation*



*Figure 22  
Installation*



Figure 23  
Installation



2. Insert the fixing clamps into the housings of the device.

Figure 24  
Installation



Figure 25  
Installation





3. Tighten the fixing clamps with a 1.5 mm hex key.

Figure 26  
Installation

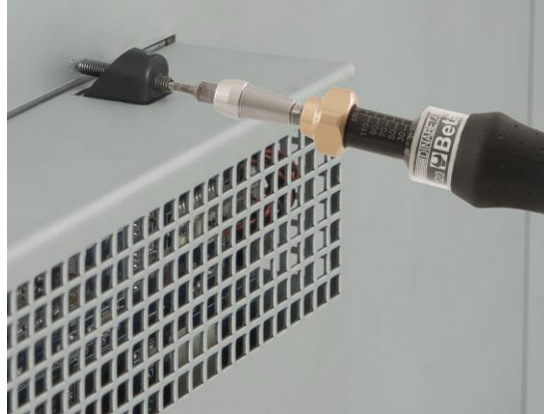

Note:

adhere to the permissible torque when tightening the threaded pin of the mounting clamp: 0.2 Nm.

Figure 27  
Installation



4. Repeat steps 2 and 3 for all mounting clamps.
5. Check the seals eat.

## 3.8 Connecting the unit

### 3.8.1 Information for the connection

- The C6 HMI / C6 HMI LC must be installed in accordance with the data contained in this instruction manual.
- This units are designed for the connection with a "Secondary Circuit Overvoltage Category II".

### 3.8.2 Power supply connection

The device may only be connected to a 24V power supply  $\overline{\text{---}}$  (max. permissible operating voltage range 18V to 36V) that meets the requirements of a safe extra low voltage (safe extra low voltage - SELV) according to IEC/EN/DIN EN/UL60950-1.

The power supply must meet the requirements of NEC Class2 or LPS in accordance with IEC/EN/ DIN EN/UL60950-1.

Connect the unit with a cable cross-section of 0.75 - 1.5 mm<sup>2</sup> (AWG18 to AWG16 suitable for min. 75°C).

- Remove the poles connector plug from the system.
- Connect the positive wire to the positive terminal of the three pole connector
- Connect the negative wire to the negative terminal of the three pole connector
- Connect the earth ground wire to the ground terminal of the three pole connector

(also refer to the label on the back of the system)



Attention: The system must be powered with a voltage of 24V (18V ÷ 36V).

Figure 28  
Power supply connection detail

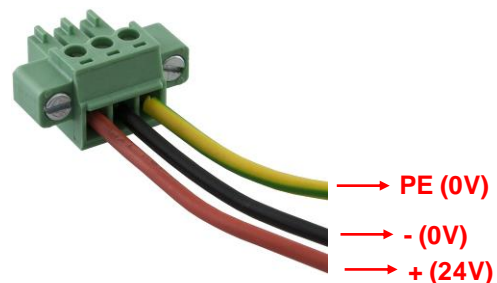



Note:  
Value of tightening torque: 0.22 – 0.25 Nm.

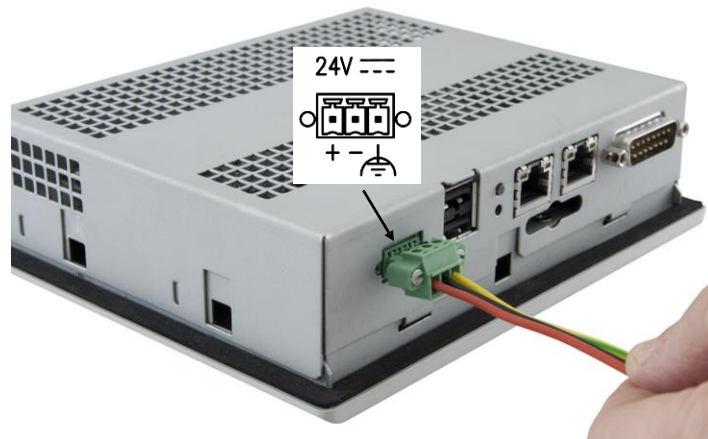

Figure 29  
Power supply connection details

### 3.8.3 Switching on and testing the device

Connect the power supply cable to C6 HMI / C6 HMI LC. Switch on the power supply. Switch on the power supply. The green led will light.



Figure 30  
Power supply connection details

The display will switch on accordingly, and after few seconds the Windows CE desktop will appear.

### 3.9 Connecting the configuration PC

You can connect the configuration PC to C6 HMI / C6 HMI LC in several ways:

- 1) By using a Ethernet cross cable connected by one end to the configuration PC and on the other end to one of two Ethernet ports of C6 HMI / C6 HMI LC.
- 2) By connecting C6 HMI / C6 HMI LC to a Ethernet switch on which the configuration PC and C6 HMI / C6 HMI LC are both connected.
- 3) By connecting C6 HMI / C6 HMI LC and the configuration PC to the office LAN.

Please note that C6 HMI / C6 HMI LC comes with DHCP service enabled. That means in case number 3 above it is sufficient to connect the C6 HMI in LAN; the LAN DHCP server automatically assigns a IP address to the C6 HMI / C6 HMI LC.

If no DHCP server is available, assign a static IP address to the C6 HMI / C6 HMI LC which is compatible with the IP address of the configuration computer.

Example: If the PC has the IP address 172.17.17.20, the C6 HMI / C6 HMI LC must be configured with the IP address 172.17.17.182. To configure the IP address on the table:

- Click on Start -> Settings -> "Network and Dial-up Connections"



Figure 31  
Connecting the configuration PC

- According to the Ethernet port you want to configure, select the port to configure according to the following table:

LAN-Port of the C6 HMI / C6 HMI LC	LAN connection in the control panel
LAN1	General purpose
LAN2	COMBIVIS connect

Table 23  
Connecting the configuration PC

- For instance if you need to configure LAN1 double click on FEC1, Click on "Specify an IP address" and write the IP address and default Gateway like in the figure below

Figure 32  
Connecting the configuration PC

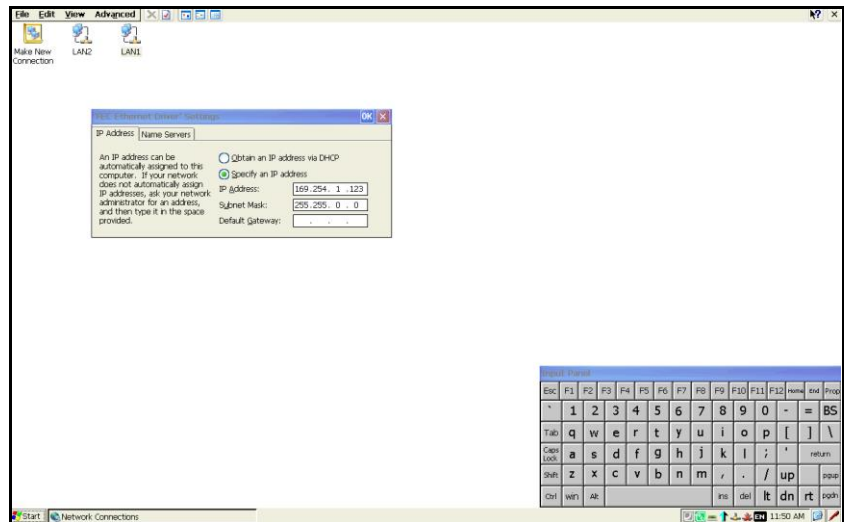

- Click on Ok to save the settings.
- Click on Start -> Settings -> Control Panel

Figure 33  
Connecting the configuration PC

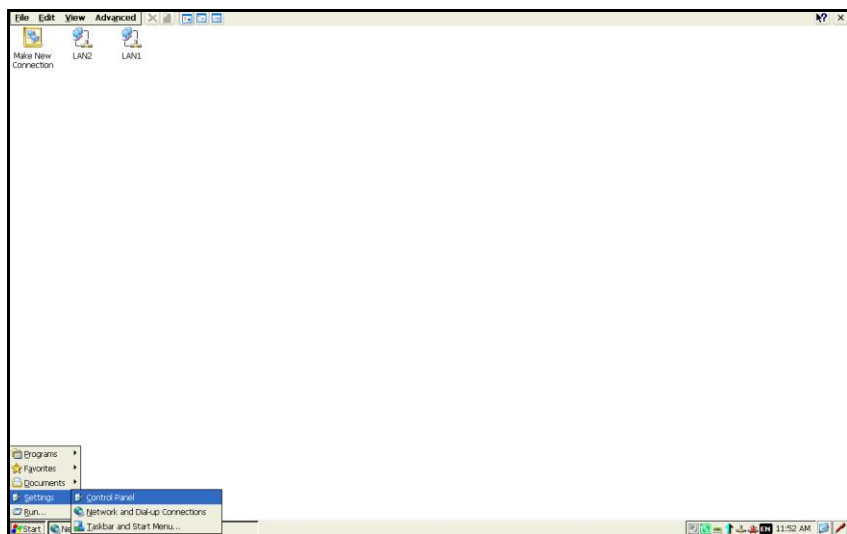

- Then doubleclick on “Registry Saver”

Figure 34  
Connecting the configuration PC

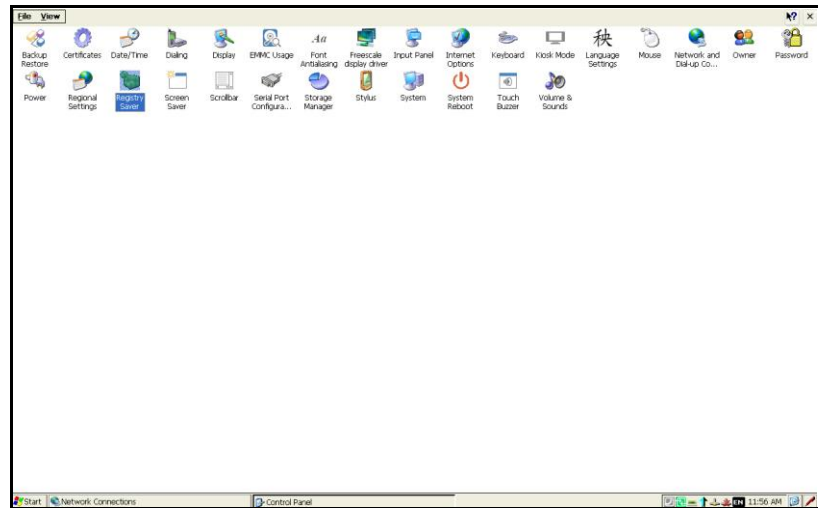

- Click on the “Save” button and confirm clicking on “Ok”. This operation will save your setting in a permanent way.

Figure 35  
Connecting the configuration PC

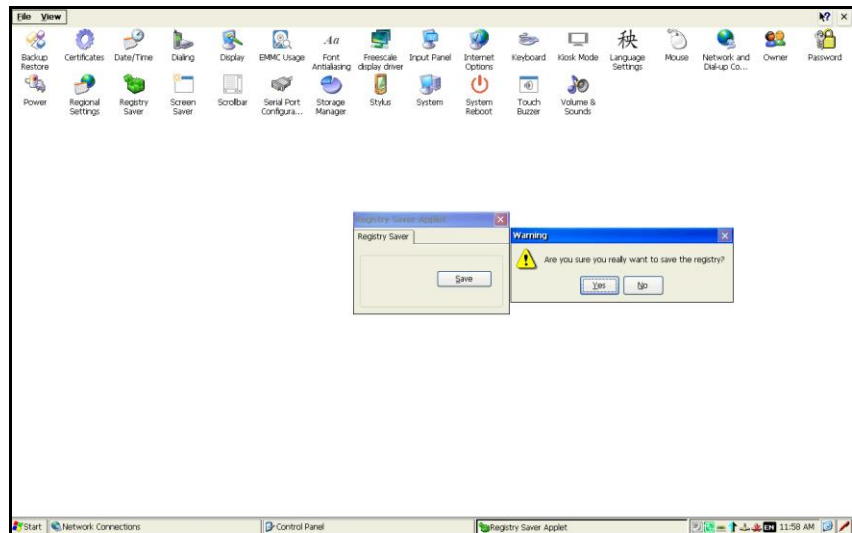

### 3.9.1 Procedure

After the connection between C6 HMI / C6 HMI LC and the configuration PC, to transfer the project into C6 HMI / C6 HMI LC you must:

- Start COMBIVIS studio HMI Developing tool.
- Load the project to transfer.
- Click on the transfer icon (see picture below).

Figure 36  
Connecting the configuration PC



The following window will appear:

Figure 37  
Connecting the configuration PC



Attention: please transfer the project into the MMC Memory or into the SD card. This allows you not to lose its content when C6 HMI / C6 HMI LC will be switched off. To transfer the project into the MMC Memory, you must specify MMC Memory (like in the example of the picture above).

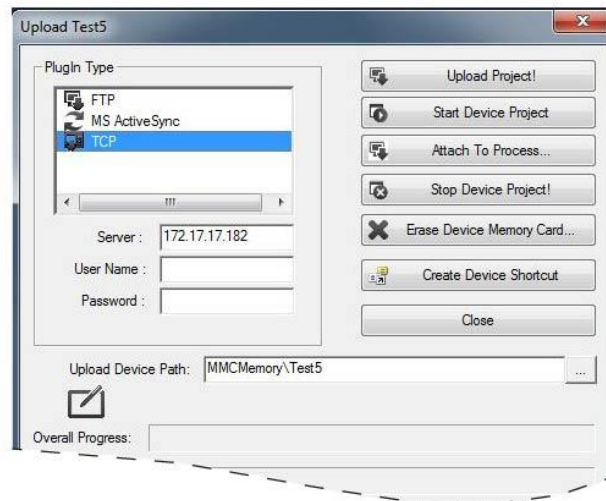

- Select TCP in the upper left list.
- Write the IP address of C6 HMI / C6 HMI LC.
- Choose where to download the project into C6 HMI / C6 HMI LC specifying the "Upload Device Path".
- To transfer the project to C6 HMI / C6 HMI LC click on the button "Upload Project!".

Alternatively, the project can be transferred with a USB stick as another option.

- Copy from the configuration PC to the USB Key the folder in which is stored the C6 HMI / C6 HMI LC project.
- Insert the USB key into the C6 HMI / C6 HMI LC.
- Copy the project folder from the USB Key to the MMC memory.

Note: the name of the memory card are according to the following table:

Table 24  
Procedure

Memory	Name used by Windows Explorer	Note
NAND	NANDFlash	Used internal memory to store the operating system. It is a read only memory.
MMC	MMCMemory	Memory to store data and executables. Read and Write memory.
SD	SDMemory	Removable Memory. Read and Write memory.
USB Key	Hard Disk	USB key inserted into a USB port of C6 HMI / C6 HMI LC.

In the picture below an example of file Explorer on C6 HMI / C6 HMI LC.

Figure 38  
Connecting the configuration PC

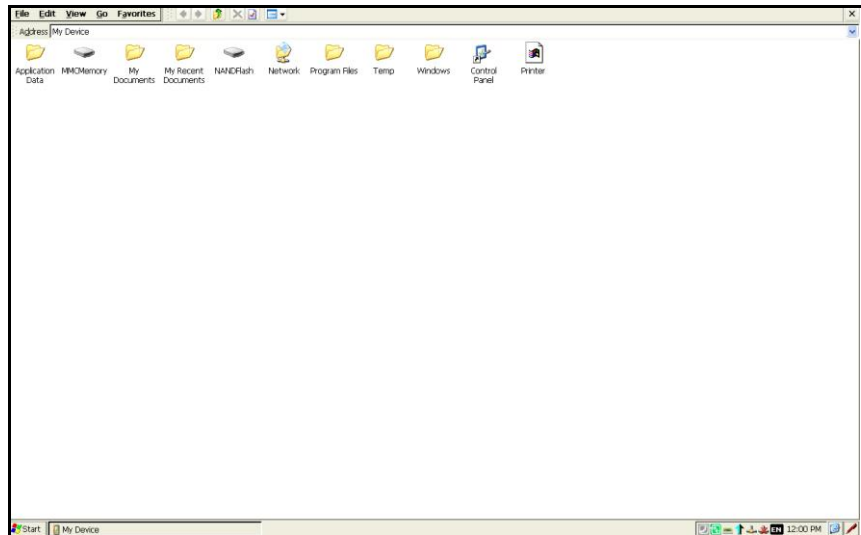



**SECTION 4****Commissioning the  
device**

## 4.1 Memory

The C6 HMI / C6 HMI LC is equipped as standard with two memories: a NAND flash memory and an e-MMC memory card. Purpose of the NAND memory is to store the boot loader (is used during the start-up of the C6 HMI / C6 HMI LC), the operating system and all executable programs. Writing on the NAND memory can be switched on and off with a special program in order to protect the saved data on the NAND memory.

The e-MMC memory cards can be used to store other data such as process data or other executable programs. It is not possible to switch off the writing of MMCs. You can always read and write the eMMC memory. This memory is used to store data which are generated during the operation of the machine or plant and monitored by the C6 HMI / C6 HMI LC.

## 4.2 Internal memory

The NAND memory, as default is read only. In this manner it is protected against data loss; but the NAND memory can be made writeable.

To make the NAND memory writable, click in the Windows folder of the C6 HMI / C6 HMI LC on MakeNANDWritable (see picture below). By this way, you can store some exe files permanently safe. After the operation you can make the NAND memory "read only" as before.

In order to set the NAND memory to "read only", click in the C6 HMI / C6 HMI LC Windows folder on MakeNANDReadOnly (see picture below).

Figure 39  
Commissioning the device

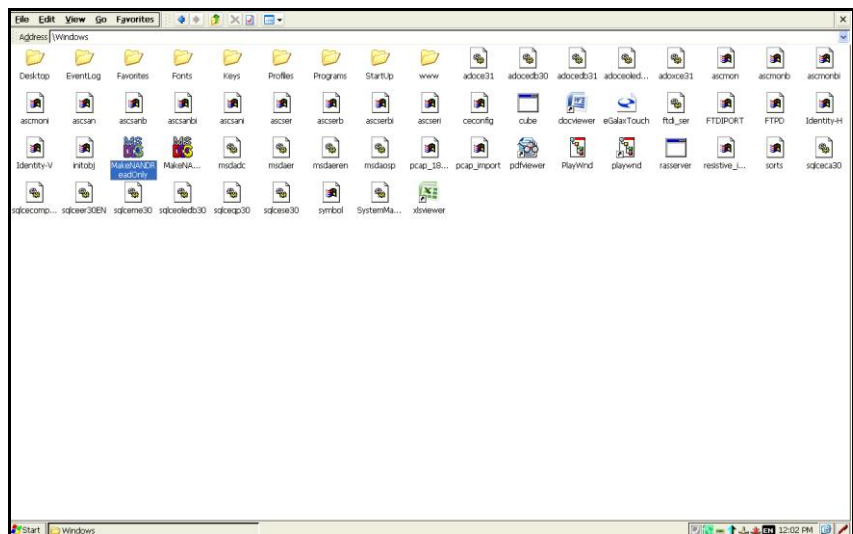

### 4.3 Slot for memory card (from 5.7")

C6 HMI / C6 HMI LC can optionally accommodate an SD/SDHC card slot V. 2.0 (push-push type).

Figure 40  
Slot for memory card

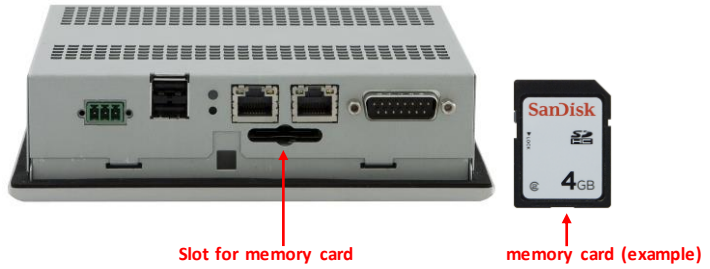

Attention: potential data loss  
Do not remove the memory card while data is being accessed.  
Data on the memory card is lost if you attempt to remove it while C6 HMI / C6 HMI LC is accessing its data.

### 4.4 Installation/removal of a memory card

- Insert the memory card into the slot as indicated in the figure. Pay attention to the beveled edge.

Figure 41  
Slot for memory card

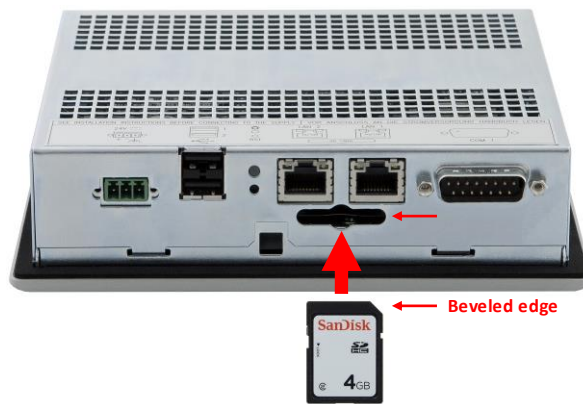

Attention: removing the system memory card while the project is running. If you remove memory card while a project is running, the project may stop.

- Push the card all the way.

Figure 42  
Slot for memory card



Figure 43  
Slot for memory card



- Push the card previously inserted.

Figure 44  
Slot for memory card



- Extract the memory card from the slot.

Figure 45  
Slot for memory card



SECTION **5**  
**Commissioning a  
project**

---

## 5.1 COMBIVIS studio HMI project

### 5.1.1 Overview

#### Configuration phase

A project includes screen, alarms, variables used to represent the real plant of machine. The configuration phase is the creation of the project according to the user needs and interaction between the humans and the machine.

#### Transferring the project to C6 HMI / C6 HMI LC

You can transfer a project to C6 HMI / C6 HMI LC as follows:

- Transfer from the configuring PC by using an Ethernet connection
- Copy the Project by using a USB key

#### Process control phase

After the project is transferred, C6 HMI / C6 HMI LC is ready to communicate to one or more PLC and to visualize the screens according to the configured project.

**ATTENTION:** if you need to communicate with a device connected to the serial port you must configure the serial port. See chapter 5.1.3.

#### Commissioning and re-commissioning

When you switch on the first time C6 HMI / C6 HMI LC, there is no project inside. At first you need to transfer a project into C6 HMI / C6 HMI LC.

After you have downloaded a project, you can retransfer another project or another version of the same project without any special operation; also while the project is running on C6 HMI / C6 HMI LC.

### 5.1.2 Transferring

The C6 HMI / C6 HMI LC is always ready for accepting the download of a project; even when a project is running. In this way, if the C6 HMI / C6 HMI LC is connected by means of Ethernet to the configuration PC, you are able to download a new project or a new version of the same project even without stopping the project.

### 5.1.3 Configuration the serial port

If your project needs to communicate with a device connected to the serial port, you need to configure the serial port according to the type of serial connection you use for your communication. The following types of communications are supported by the serial port of C6 HMI / C6 HMI LC:

- RS 232
- RS 422
- RS 485

C6 HMI / C6 HMI LC comes as default with the serial port set as RS 232. If you want to change the type of serial communication you must do the following:

Click on Start -> Settings -> Control Panel

Figure 46  
Configuring the serial port

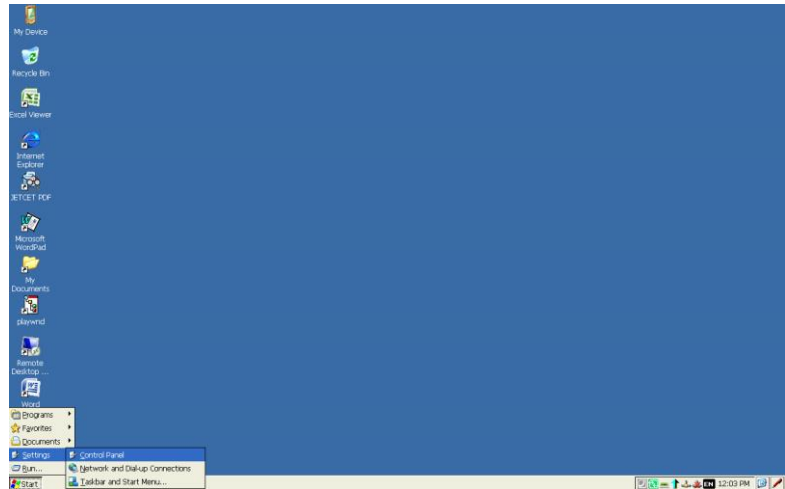

Double click on "Serial Port Configuration"

Figure 47  
Configuring the serial port

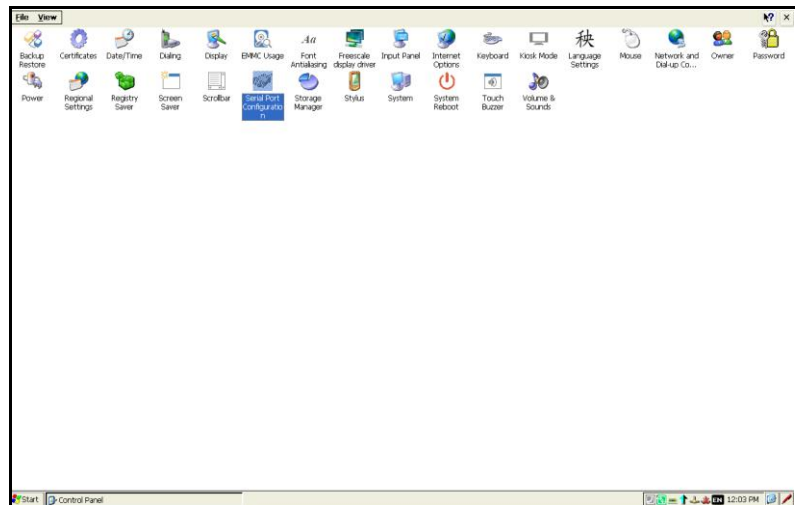

Choose the type of serial communication

Figure 48  
Configuring the serial port

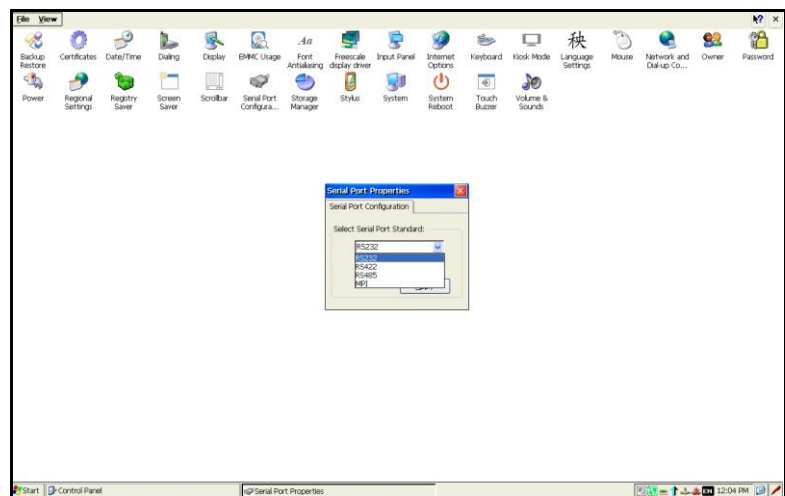

And confirm by pressing the “Apply” button. A warning message will raise, advising to store that new configuration is active and saved a permanent way.

Figure 49  
Configuring the serial port

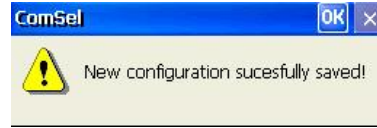

This applet can be used just to check which serial communication mode is active; in this case it is enough to push the “red cross” on the high right side of the panel. Please note that MPI mode cannot be selected: when this protocol will be used by HMI software all required settings will be applied automatically.

#### 5.1.4 Connecting the serial port

A special DB15 connector supports all serial protocols. It is therefore necessary to adapt the connections to the technical requirements; KEB can supply connector adapters as optional parts but user can adapt DB15 connector by himself.

#### 5.1.5 Project administration

The C6 HMI / C6 HMI LC has high-performance tools to manage a running project. With the same mask that is used for the project transfer (see below), you can also:

1. Stop the C6 HMI / C6 HMI LC project from the configuration PC.
2. Start the C6 HMI / C6 HMI LC project from the configuration PC.
3. Debug the project from the configuration PC.
4. Transfer the project from C6 HMI / C6 HMI LC to the configuration PC.



## 5.1.6 Stopping the running project

Figure 50  
Stop running project

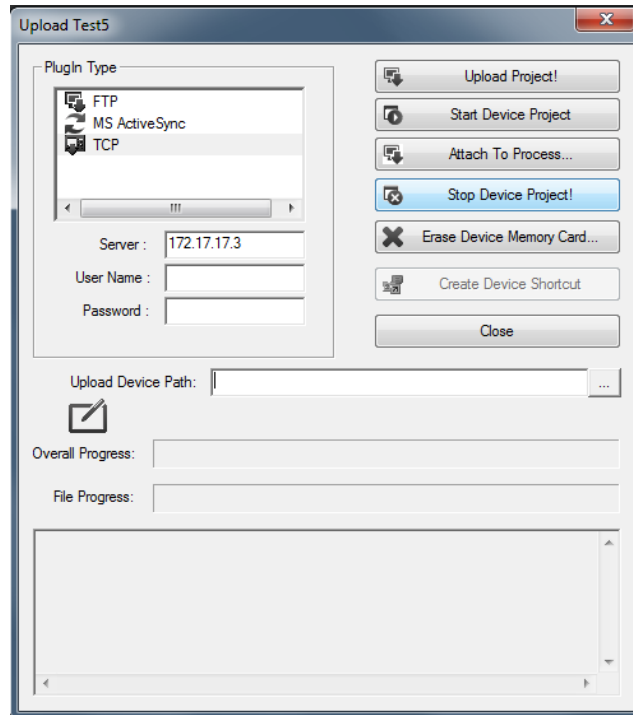

Please follow these steps to stop a running project:

5. Select TCP in the upper left list.
6. Insert the IP address of the C6 HMI / C6 HMI LC
7. Click the button "Stop Device Project!"

You will see the project in C6 HMI / C6 HMI LC stopping (see below)

Figure 51  
Picture Stop running project

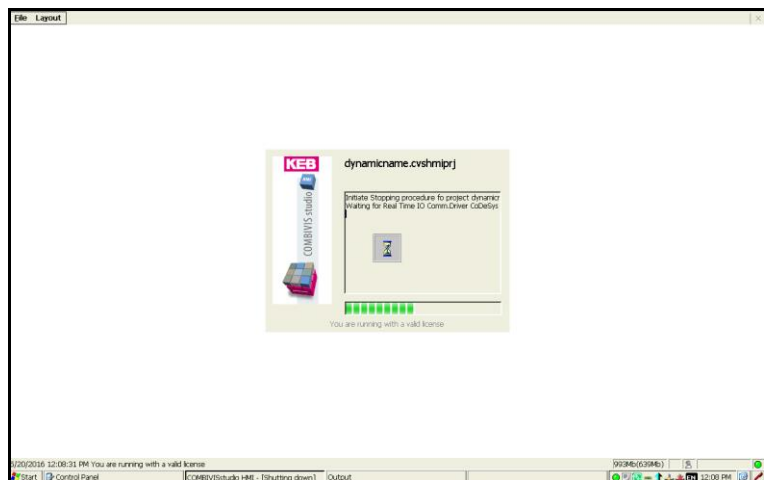

### 5.1.7 Starting the project

Picture 52  
Starting the project

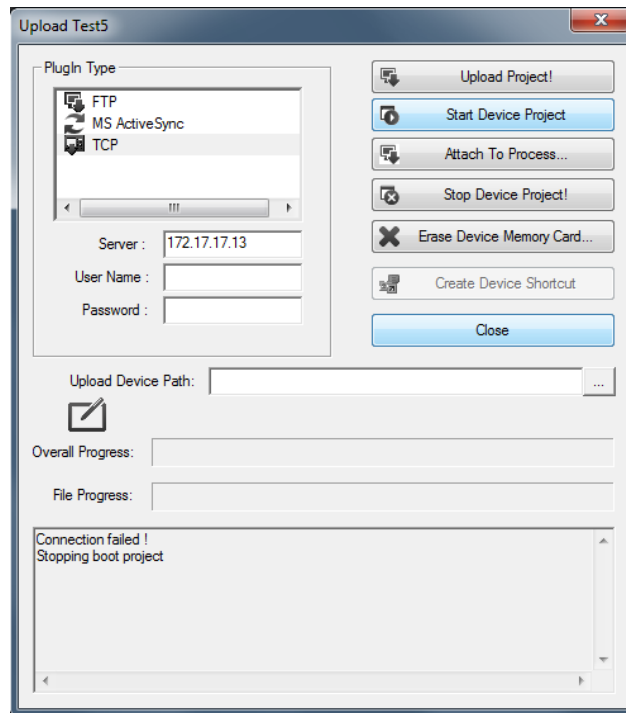

To start a project in C6 HMI / C6 HMI LC by using the configuration PC you must:

8. Select TCP in the upper left list
9. Write the IP address of the C6 HMI / C6 HMI LC
10. Click the button "Start Device Project"

Now you see how the C6 HMI / C6 HMI LC project is starting.

## 5.1.8 Debugging the project

You can debug the project in C6 HMI / C6 HMI LC by connecting with the configuration PC.

In order to be able to use the debugging functionality you must prepare your project as follows:

1. Select "Networking" in the project explorer window of COMBIVIS studio HMI
2. Enable the property "Debugger" in the Properties window of COMBIVIS studio HMI

Figure53  
Debugging the project

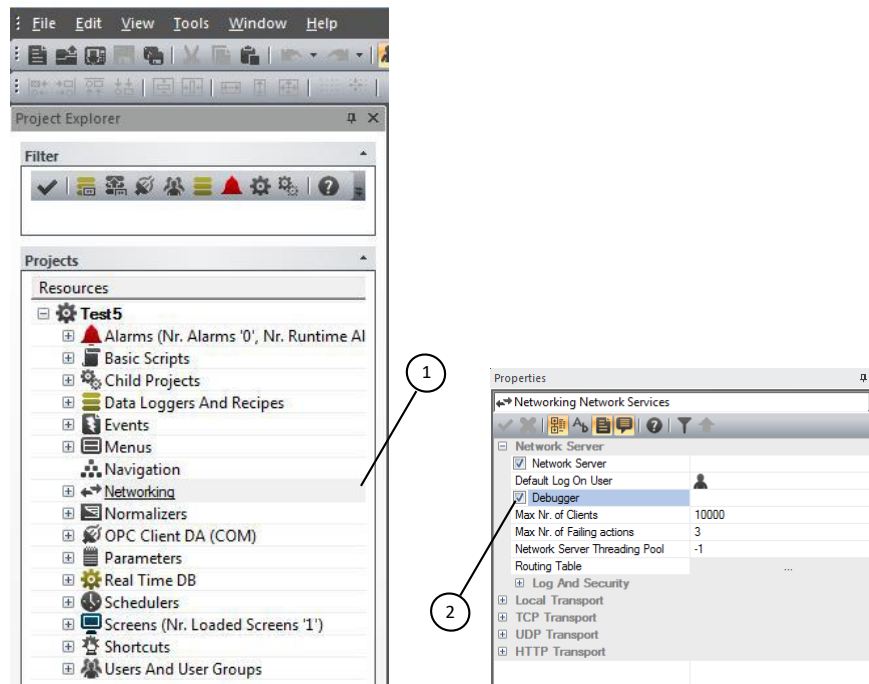

Transfer the project to the C6 HMI / C6 HMI LC and start running.

**NOTE:** Ensure that the project is running; otherwise you cannot debug it.

In order to debug the running project of the C6 HMI / C6 HMI LC from the configuration PC, follow these steps:

1. Select TCP in the upper left list.
2. Insert the IP address of the C6 HMI / C6 HMI LC

Click the button "Attach To Process..."

Figure 54  
Debugging the projects

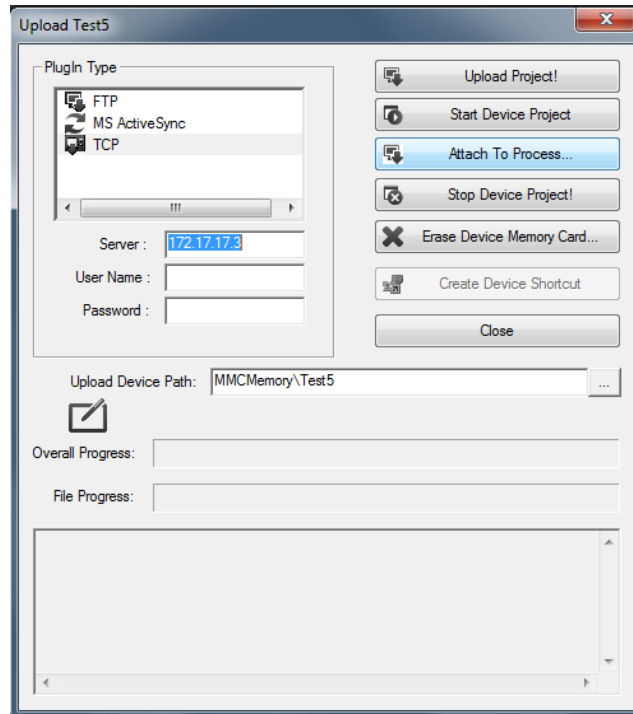

The following window will appear.

Figure 55  
Debugging the project

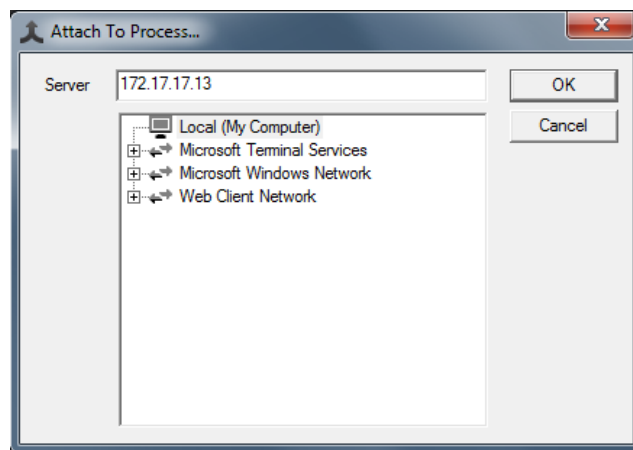

Enter the IP address of the C6 HMI / C6 HMI LC and click "OK". A new window opens that asks for the user and the password

If the project is not protected, just click the "OK" button, otherwise enter the name and password of a project user who has the rights to modify the project.

Now you can see debugging is starting in COMBIVIS studio HMI on the configuration PC. Now you can:

- see the project screens and navigate between them. Please note you see a different screen than that of the C6 HMI / C6 HMI LC and the debugging does not affect normal operation of the C6 HMI / C6 HMI LC project.
- View and change the value of the variables
- Set a breakpoint and debug the Visual Basic scripts running in the project

### 5.1.9 Transfer the project from C6 HMI / C6 HMI LC to the configuration PC

This option allows you to transfer the project from C6 HMI / C6 HMI LC to the configuration PC in order to check or to change and hence transfer again into C6 HMI / C6 HMI LC.

**Note:** It is always suggested to protect the project with a password in order to don't allow changes to the project by not a authorized users.

Be sure that the project is not running on C6 HMI/C6 HMI LC, run COMBIVIS studio HMI on the configuration PC, click on the "File" menu and select "Open Device Project..."

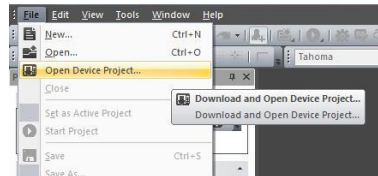
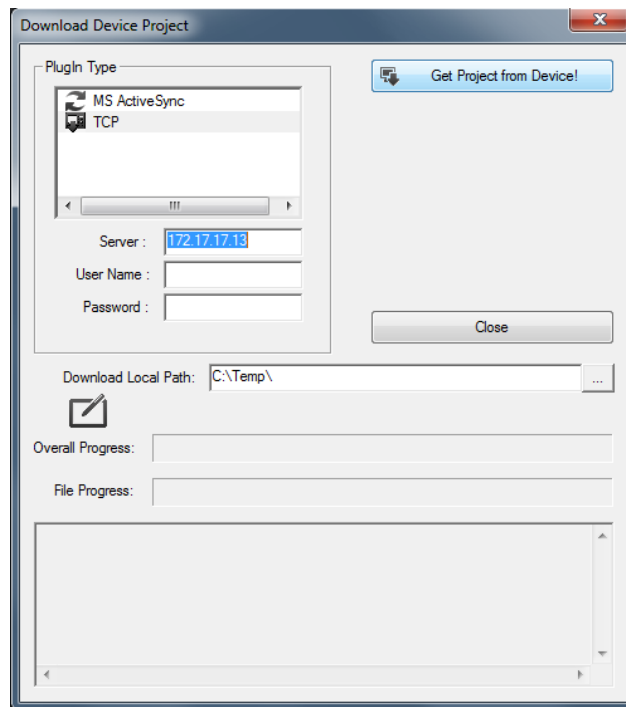

Figure 56  
Debugging the project

1. Select TCP in the upper left list
2. Insert the IP address of the C6 HMI / C6 HMI LC
3. Write the path on which you want to store the project on your configuration PC
4. Click on the button "Get Project from Device!"

Figure 57  
Debug the project



After the transfer of the project you will see the project explorer containing the project resources in COMBIVIS studio HMI and you will be able to check, test and change the resources of the project.

### 5.1.10 Backup and restore

The C6 HMI / C6 HMI LC has tools to backup and restore the contents of its internal memory in order to manage the project and the operating system of C6 HMI / C6 HMI LC. For further information please contact the KEB Support Center.

### 5.1.11 Update the operating system

Please contact the Support Center of KEB.

## 5.2 COMBIVIS studio 6 project

This chapter is valid only for C6 HMI LC systems which are coming with CONTROL Runtime pre-installed directly from production.

### 5.2.1 C6 HMI LC – Implementation “CONTROL Runtime”

The CONTROL Runtime runs as a thread with “real time” priority. The execution model is based on the “task” concept; the program execution requires the definition of tasks and the assignment of priority and execution cycle according to the following figure (see below in this manual about how to configure COMBIVIS studio 6 for use with C6 HMI LCs system).

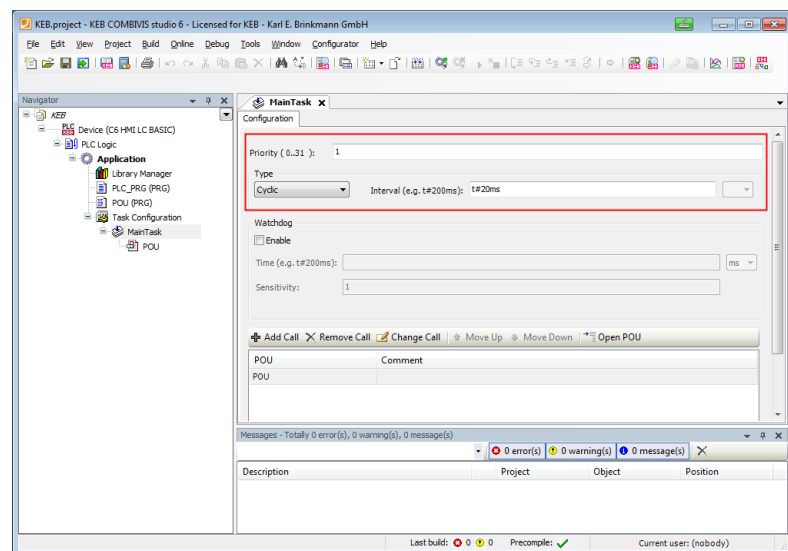

Each task is executed at the specified time interval and according to the assigned priority. Only when all the COMBIVIS studio 6 activities are over, the CPU time goes to the other processes, as they are assigned to a lower priority.

**Note:** Each task cycle time must be properly assigned according to the general performances required by the PLC itself, by the COMBIVIS HMI Runtime, by the COMBIVIS connect Runtime and by any other application or process running in the system. A too short task cycle time may introduce an undesired slowdown in the general reaction of the system. If this is the case, the task cycle time should be properly increased until you reach the proper balancing between performances and reactivity of the whole system.

## 5.2.2 Preparing the COMBIVIS studio 6 programming environment

The COMBIVIS studio 6 programming environment must be properly configured in order to support the code compiler for C6 HMI LC systems.

You need COMBIVIS studio 6 version 6.2.1.0\_3.5.3.50 or above installed on the PC.

COMBIVIS studio 6 installation can be found in the COMBIVIS studio 6 user manual.

The C6 HMI LC can be shown in the device repository.

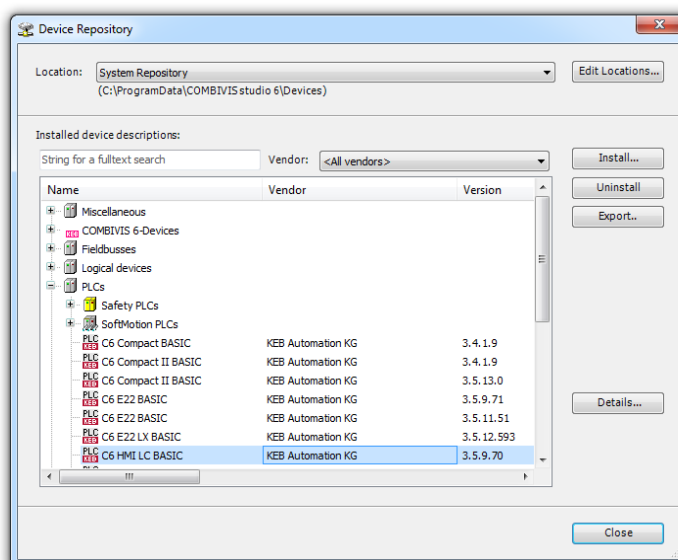



Create now a new project and insert the C6 HMI LC as new Device as shown in the following figure.

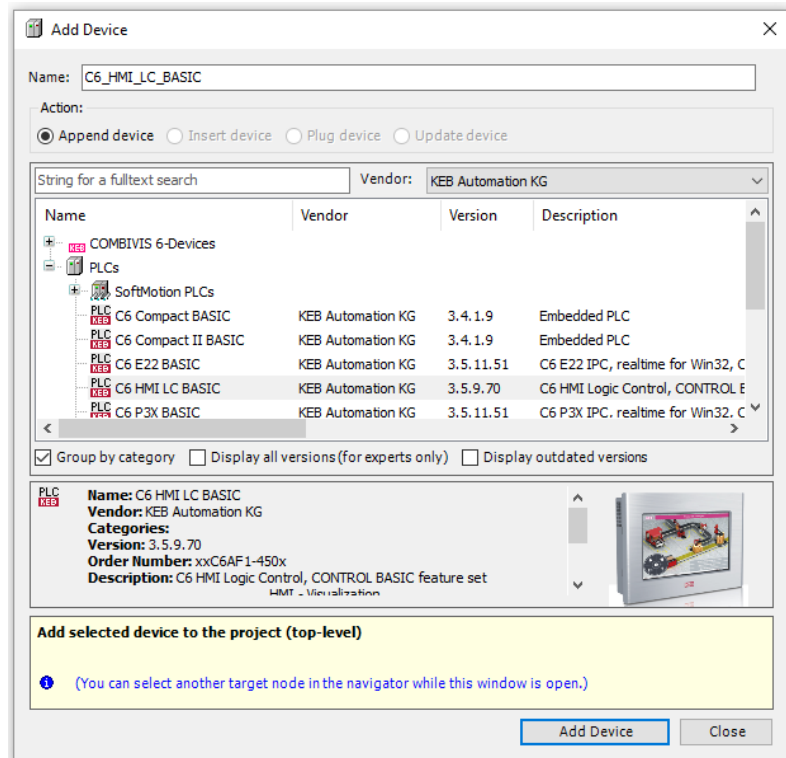

### 5.2.3 Transferring the COMBIVIS studio 6 application to the target system

To transfer a valid COMBIVIS studio 6 application to the Target system, follow these steps:

- Ensure the C6 HMI LC device is connected to the same sub network of the PC where you have running the COMBIVIS studio 6 programming tool (same network mask, e.g. "192.168.1.xx")
- Double click on the device icon from the COMBIVIS studio 6 project tree; the right part of the workspace will show the "Communication settings" tab contents
- Select the Gateway and click on the button "Scan network" button
- The box will be populated with the list of available CONTROL Runtime
- Click on the one you want to connect to and click then on the "Set active path" button
- Click Online\Login to start the communication

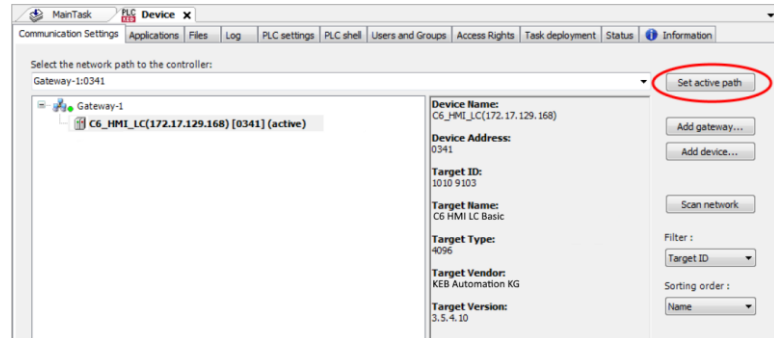

## 5.2.4 I/O Feldbus

The implementation “CONTROL Runtime” for KEB C6 HMI LC systems supports the following I/O fieldbuses:

- EtherCAT with NO DCs support (distributed clock) on LAN1
- Modbus TCP on LAN1
- Modbus RTU

To insert the I/O master right click on the C6 HMI LC device icon on the project tree, select “Add Device” and select from the “Vendor” list box. The list will be populated with the available master devices. Select the one required by your application in between:

- EtherCAT Master
- Modbus COM (for Modbus based I/O both serial and TCP)

C6 HMI LC systems are featuring two Ethernet interfaces.

The interface that must be used for I/O fieldbus is the one denominated “LAN1”.

**Note:** At the moment of transferring the PLC application to the target system, COMBIVIS studio 6 will ask to which interface the I/O must be attached. You must specify the MAC address of the “LAN1” interface as shown in the following figure.

**Note:** Current implementation is affected by a jitter of about +/- 2ms when working with I/O over Ethernet interface.

**Note:** The Ethernet interface assigned to an I/O Ethernet master (Ethercat or Modbus TCP) is exclusively dedicated to the I/O and must not be used for any other purpose (no programming, no COMBIVIS HMI protocol).

## 5.2.5 Support for retentive data

C6 HMI LC systems are equipped with a Micro UPS specifically designed to support the data memory retention.

In COMBIVIS studio 6 the retentive variables can retain their value throughout the usual program run period. They are declared as "Retain Variables" or even more stringent as "Persistent Variables". For each case a separate memory area is used. Please check the COMBIVIS studio 6 instruction manual for any additional details about retentive data.

The use of the retentive areas does not require any specific configuration except for declaring the variable in the proper area according to the COMBIVIS studio 6 programming manual.

At the moment of a power failure (when the voltage is below the threshold for more than 50ms) the UPS triggers an event and the system will switch off the display and the USB device connected in order to save energy, and will follow a four step sequence to save data:

1. The panel display and the USB ports are turned off
2. All running IEC tasks are terminated so the retentive areas are consistent
3. The system starts flushing the retentive memory areas to a file which is saved on disk
4. The CONTROL Runtime is terminated

The panel continues to run until the Micro UPS is able to provide power to C6 HMI LC.

**Note:** To start the backup procedure the super capacitors must be fully charged.

**Note:** The available retentive memory size is of 64 kB for the RETAIN memory type and 64 kB for the PERSISTENT memory type.

**Note:** If the power supply returns before the energy inside the Micro UPS is finished, and actually C6 HMI LC has not been switched off, the following operations are carried on:

- The display is switched on.
- The USB ports are powered.
- CONTROL Runtime behavior can be selected in between 3 possible models:
  - a. CONTROL Runtime does not start and no message is returned.
  - b. CONTROL Runtime does not start and returns a warning message.
  - c. CONTROL Runtime restarts normally (default option).
  - d. The charging status of the UPS can be checked using the UpsInterface object (IoDrvUPS), which is linked to the target device C6 Smart.

The COMBIVIS STUDIO 6 restart behaviour can be configured directly by the user with the help of the COMBIVISSTUDIO 6 Launch-Manager program. The Launch-Manager of the CONTROL Runtime is an application stored in the "\MMCMemory\CoDeSys3" folder, as shown in the following figure.

Figure 58  
Start CDSlaunchMgr.exe

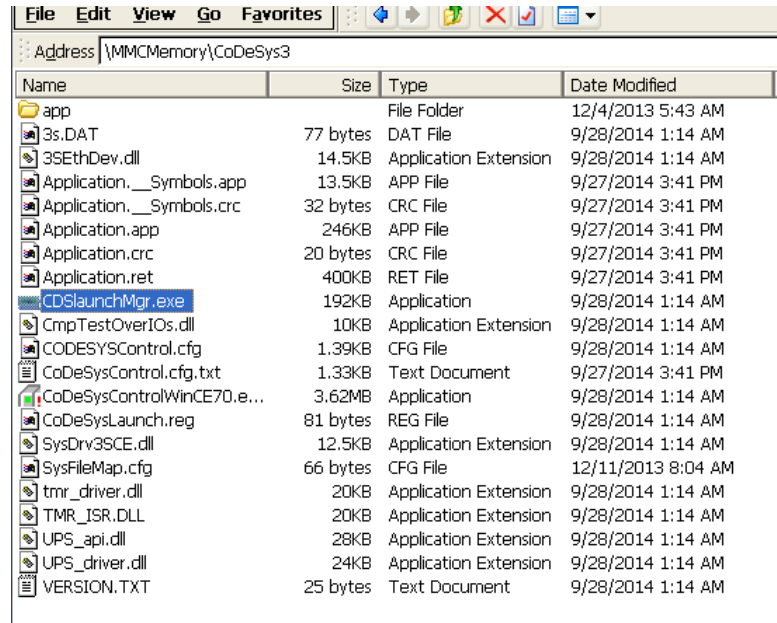

To start it, double click on the file name.

The Launch-Manager interface is shown in the following figure.

Figure 59  
CDS Launch-Manager

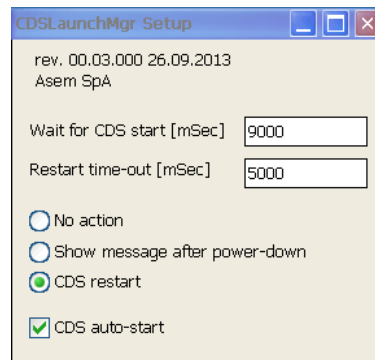

The parameter "Wait for CDS start" specifies the time the Launcher waits before the CONTROL Runtime starts.

"Restart time-out" is the time the Launcher waits before the CONTROL runtime re-starts.

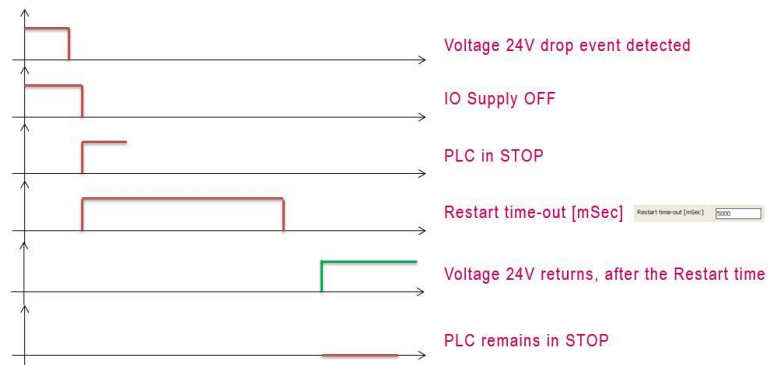
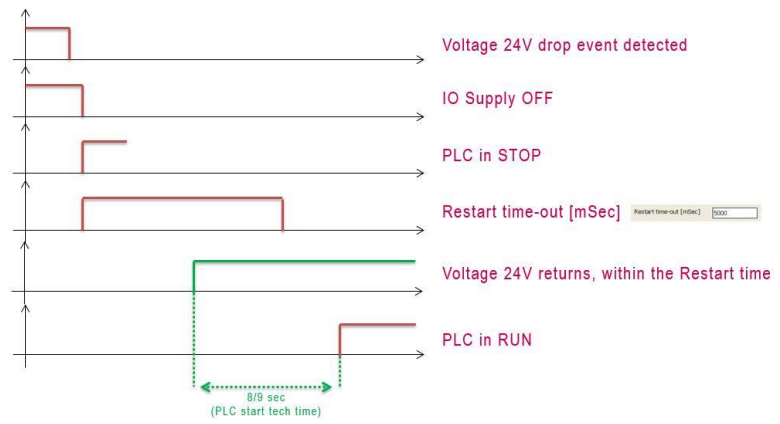

### 5.2.6 Use in combination with COMBIVIS HMI Runtime

COMBIVIS HMI Runtime can be of course configured to communicate with the CONTROL Runtime.

The C6 HMI LC includes the Gateway which is then used as communication interface.

The COMBIVIS studio HMI project must be configured to communicate with a generic CODESYS controller inserting in the "Real Time DB" resource the driver called "CODESYS" as shown in the following figure.

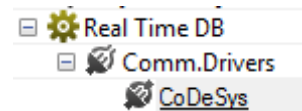

The protocol uses a socket to communicate with the CONTROL Runtime through the Gateway component.

The Station must be configured to connect to “localhost”. The device name is the one shown by the programming system COMBIVIS studio 6 when connected online with the C6 HMI LC device from the “Communication settings” window.

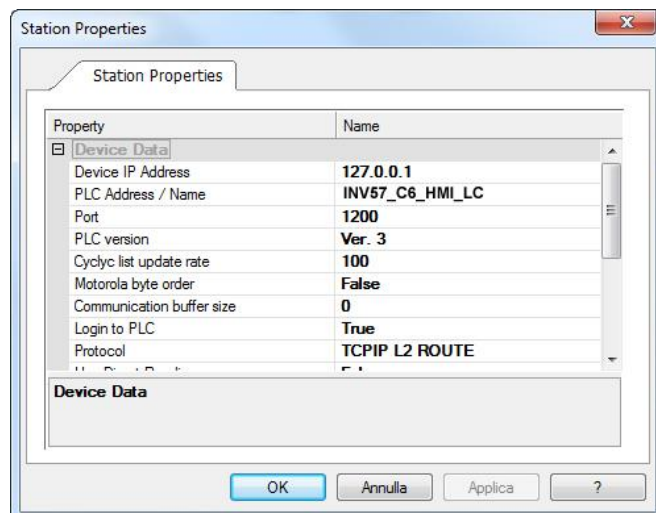
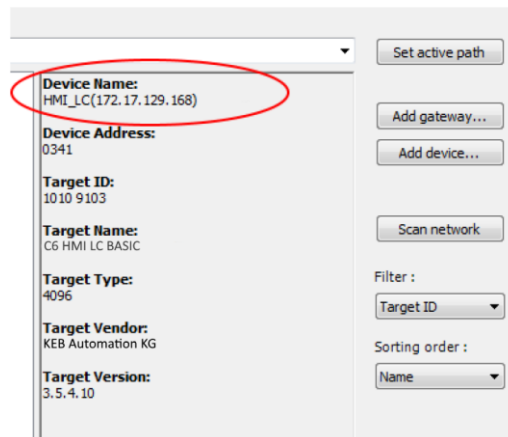

The CONTROL Runtime running on a C6 HMI LC device can be reached also from a panel which has been configured to belong to the same sub network. When having on the same sub network more than one C6 HMI LC system, you need to assign to them different name.

**Note:** In case the CONTROL Runtime is using Ethernet based I/O, the COMBIVIS studio HMI project must not be configured to use Ethernet protocols. The “LAN” interface is exclusively dedicated to the I/O, while the “WAN” interface is dedicated to the Internet connection for COMBIVIS connect and cannot be used as protocol port.

**Note:** The COMBIVIS studio HMI project can be configured to communicate with more than one controller; in these cases the system can act as a gateway and transfer data through the different channels. For further information about this feature consult the COMBIVIS studio HMI online manual searching for “Variable Commands” and then “Move Value”.

## 5.2.7 Use in combination with COMBIVIS connect

The C6 HMI LC systems are featuring COMBIVIS connect Runtime as preloaded and pre-configured.

The COMBIVIS connect VPN connection can be naturally used to connect from remote to the CONTROL PLC through the integrated Gateway. Once the VPN is activated, just follow the usual steps to get the online connection.

Please see the COMBIVIS connect Control Center online manual for further information about how to use the COMBIVIS connect software.

## 5.2.8 Limitations and recommendations

In order to get the best balancing between functionalities and performances we strongly suggest to follow some guidelines when designing the applications for COMBIVIS studio 6 and COMBIVIS studio HMI.

- The PLC cycle time must be greater or equal than 10ms; the average jitter has been measured around +/- 2ms
- In general the CPU time reserved to CONTROL Runtime shall not be greater than 25%; this is calculated using the real time required by the PLC Runtime to complete the cycle and the time left free for all the other processes.

**Note:** The maximum CPU time usable for the COMBIVIS studio 6 application is fixed from a system parameter; in case the PLC program gets more than 25% of the CPU time, the CONTROL Runtime will be stopped. The user shall then properly change the PLC task timing in order to respect the limitation.

- The maximum number of bytes exchanged between COMBIVIS studio HMI Runtime and CONTROL Runtime shall not be greater than 1024
- The sampling time specified for data acquisition shall not be less than 15sec
- The scripting shall be carefully used in order to leave enough time to the other tasks to run without impacting too much with the general reaction of the overall system.
- If the project has been configured to use the Web Client, you should consider that when an external client is connect you may experience a slowdown of the page change performance of the COMBIVIS HMI Runtime
- The "S7-MPI COMx" communication protocol from COMBIVIS studio HMI is not supported.

SECTION **6**  
**System-Manager**

---



The System-Manager is a tool for all ARM and x86 based KEB systems with WinCE operating system. It is available as an integrated component of the operating system.

The aim of the System-Manager is to provide comprehensive support for system-specific functions such as cloning, selective system component backups and associated restore operations, system font settings and screen saver options.

The System-Manager is available as a set of control panel applications:









<b>Backup Restore</b>	 Backup Restore
<b>Font Antialiasing</b>	 Font Antialiasing
<b>Screen Saver</b>	 Screen Saver
<b>Touch Buzzer</b>	 Touch Buzzer
<b>EMMC Usage</b>	 EMMC Usage
<b>Kiosk Mode</b>	 Kiosk Mode
<b>Language Settings</b>	 Language Settings
<b>Scrollbar</b>	 Scrollbar
<b>System Reboot</b>	 System Reboot

Figure 60  
System-Manager system control applets



**Note:** Before you start the backup or restore process, the CONTROL Runtime must be stopped. Otherwise, the backup or restore process can take a very long time!

Figure 61  
Backup Restore



Backup  
Restore



**Note:** The settings saved by the cloning process refer to the system (IP address, network configuration, system time, etc.) and to the installed application (Control Project, HMI, Connect). User-specific settings (with the exception of the autorun keys)

## 6.1.1 Backup Restore

The "Backup Restore" utility interface is shown in the following figure.

The program offers two functions:

- System clone und Restore
- Selective functions Backup and Restore

## 6.1.2 System clone und Restore

To save a system clone and the selective backup function, the System Manager program uses a single file with the extension ".ASR", which contains all the information and data that will later be needed for the restore.

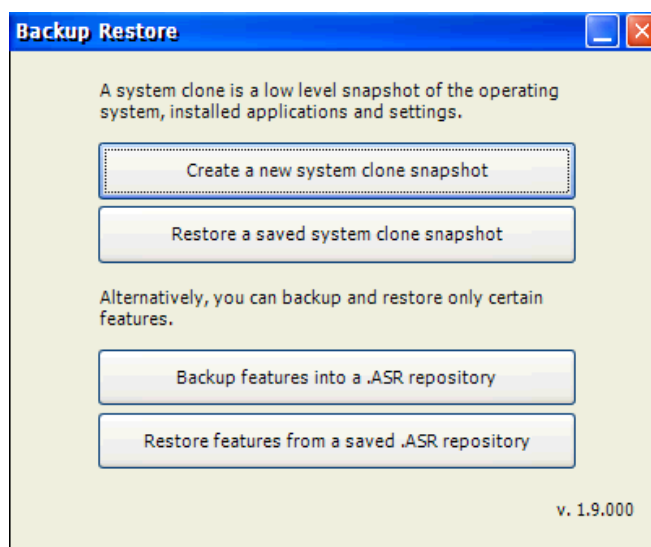

The system clone creates a low-level snapshot:

- of all files on the hard disk
- of the operating system configuration from the registry
- of the application configurations from the registry

To work with the clone process, click the "Create a new system clone snapshot" button.

The clone process has two optional settings:

- 1) Operating system illustration: allows to create a clone of the operating system ROM image.
- 2) User-defined registry keys: allow to store user-defined keys in the backup.



**Note:** Target path for the clone file can only be an external memory like a USB stick.



**Note:** Restoring a clone snapshot is not possible selectively.



**Attention:**

Please note that when restoring a clone snapshot to a system connected to COMBIVIS connect Domain, the COMBIVIS connect Identity is also restored. This means, if the target device was already assigned to a COMBIVIS connect Domain, it loses its original identity. In case the original identity must be retained, save the file "auth.bin" from the COMBIVIS connect runtime installation folder before restoring the clone snapshot. When restoring the backup function, the COMBIVIS connect identity of the target device must be retained instead.



**Note:** If the System-Manager cannot determine the compatibility condition, a warning message is displayed and the user has the decision to perform the process.

Click on "Run" to start the process.

You are prompted to specify a path where the clone snapshots should be stored.

As soon as the process has started, the status bar at the bottom of the System-Manager application informs about the running process.

To restore a Clone Snapshot, click the "Restore a saved Clone Snapshot" button and locate the ".ASR" repository file.

The status bar at the bottom of the System-Manager application informs about the current process.

The restore process enables the automatic shutdown of running processes (control project, HMI, connect). Replacing files from the archive and the processes restart at the end.

#### Check compatibility

A Clone Snapshot can be restored on the system on which it was created or to another device.

During the restore process, the system manager program checks whether the snapshot is compatible with the current hardware.

#### Selective backup and restore processes

The selective backup supports only certain and selected backup functions, files and application settings.

**Attention:**

The backup of the studio HMI application enables the backup of all user applications on a "MMC Memory" flash-disk. In case the data folder has been moved from the standard path, it will not be saved in the backup.



**Note:** The target file for the selective backup file can be an internal or external storage disk.



**Note:** If the System-Manager cannot determine the compatibility condition, a warning message is displayed and the user has the decision to perform the process.

As soon as the process has started, the status bar at the bottom of the System-Manager application informs about the running process.

To start the selective backup, click on the button "Backup-features into a .ASR repository".

The program shows a list of the available functions and settings that are saved. The window is self-explanatory, follow the instructions on the screen and activate the checkbox of the functions you need for a backup.

Once the selection is complete, press Run to select the destination path and start the process.

To start the selective backup, click on the button "Restore features from a saved .ASR repository" and find the archive.

Once the archive is loaded, press the "Details" button to check the contents. A complete list of all functions available in the .ASR archive, including the application version, is displayed.

The restore process offers the automatic shutdown of running processes (control project, HMI, connect), the replacement of files from the archive and the restart of new processes at the end.

The restore process may require several system restarts; the process is fully automated.

**Check compatibility**

A selective backup can be restored on the same system as before or to another device.

During the restore process of the operating system, the System-Manager checks whether the archive content is compatible with the current hardware or not.

**Note:**

*Font anti-aliasing is only supported by ARM-based devices (C6 HMI, C6 HMI LC, C6 SMART).*

### 6.1.3 Font Antialiasing

The program allows to set the rendering options for the font.

Double-click the control panel icon and select the required playback option. Click OK to confirm.

The settings are automatically stored in the registry and manual storing is not required.

Figure 62  
Font Antialiasing

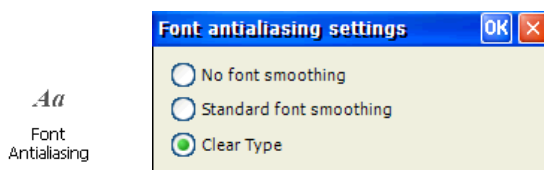

## 6.1.4 EMMC Usage

The utility provides useful information about using the eMMC memory together with the status display.

Figure 63  
EMMC Usage

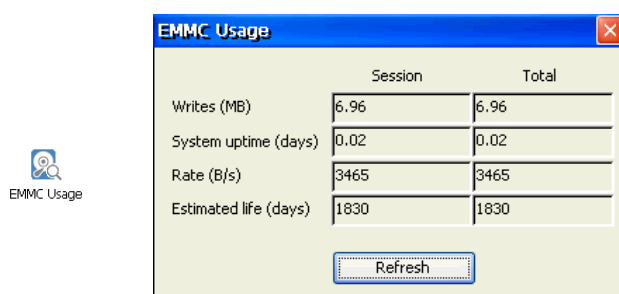

The provided information is divided into current session (since the last reboot) and total (since the system manager utilities were installed).

The utility contains the following information.

<b>Writes (MB)</b>	Written data on the eMMC memory in MB
<b>System availability (days)</b>	Days since last power on
<b>Rate (B/s)</b>	Average write speed calculated in B/s, considering the amount of written data and runtime
<b>Estimated runtime (days)</b>	The estimated memory lifetime is calculated considering the maximum possible write operations (information from the memory manufacturer) and the rate of generated write operations.

### 6.1.5 Kiosk Mode

The program allows the activation of the kiosk mode.

If activated, the panel directly starts the HMI Runtime with a associated project without Windows CE Explorer.

Figure 64  
Kiosk Mode

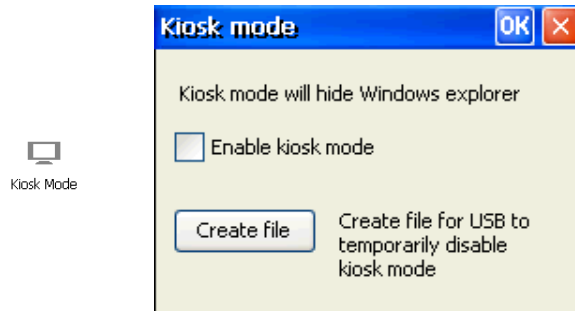

To activate the kiosk mode, open the utility program and select "Enable kiosk mode" in the checkbox

At the moment when you activate the kiosk mode, you can also create a file that allows the temporary deactivation of the kiosk mode. The file is created with the "Create file" button. Insert a USB stick into a USB port and save the file directly in the root directory of the USB sticks.

When the USB stick is plugged in, the file is automatically recognized and the kiosk mode is immediately deactivated until the next switch-on procedure.

If you did not create the file immediately when kiosk mode was activated, you can create it manually yourself.

Create a text file with the name "SystemManager.xml". Open it with any text editor and copy into the following text.

```
<?xml version="1.0" encoding="utf-8"?>
<SystemManager>
  <Commands>
    <Command Type="RunProcess" FilePath="explorer.exe" Arguments="" WaitCompletion="0"/>
  </Commands>
</SystemManager>
```

Save the file and use it as explained above.



**Note:**

*If Kiosk Mode is activated and the HMI Runtime has finished, or closed with the correct command, the Explorer will not start automatically and you will obviously get into a situation where the screen is locked and does not respond. To avoid this annoying state, it is sufficient to consider the Start Explorer command before shutting down the runtime, as shown in the figure below.*

Figure 65  
Launch Explorer of COMBIVIS studio HMI

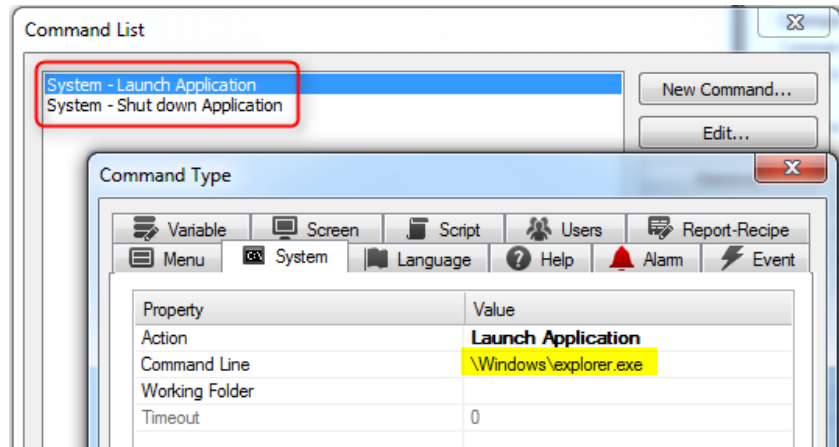

### 6.1.6 Language Settings

The program offers fonts for Chinese, Japanese and Korean languages

Figure 66  
Language settings

秧  
Language  
Settings

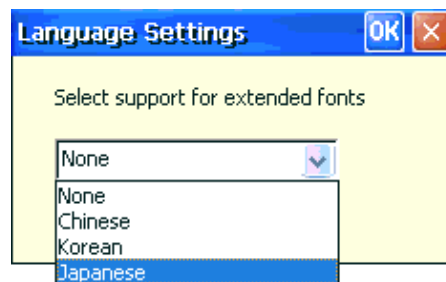



### 6.1.7 Scrollbar

The program allows the change of the size of the Windows scrollbars. This is useful when creating applications with HMI, because some of the standard controls get the scrollbar size information from the operating system.

Figure 67  
Configure Scrollbar

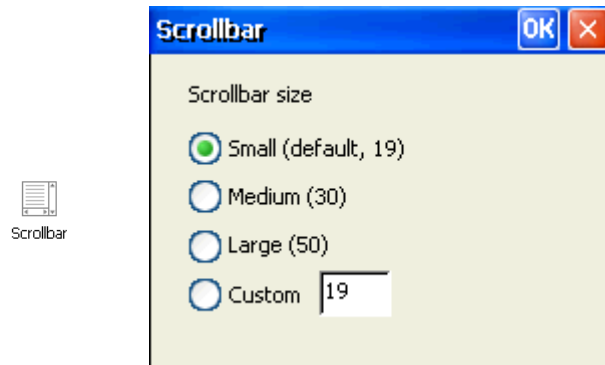

Select the required size of the scrollbars from the window and confirm.

### 6.1.8 System Reboot

With this program you can restart the system.

Figure 68  
System Reboot

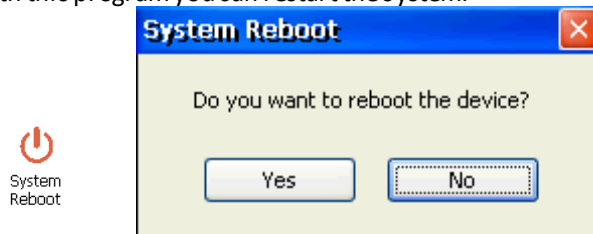

### 6.1.9 Assign network settings via text file to USB stick

You have the option of assigning the network settings by using a USB stick that contains a file called IPConfig.csv.

The CSV file must be formatted as follows:

DHCP, IP address, subnet, gateway

Here a few examples:

1

0,172.19.17.27

0,172.19.17.27, 255.255.255.0

0,172.19.17.27,255.255.255.0,172.19.16.1

1,172.19.17.27

The program looks for a CSV file called Ipconfig.csv, which is located in the same path and starts as soon as the USB stick is inserted.

SECTION **7**  
**Maintenance**

---

## 7.1 Calibration of the touchscreen

C6 HMI / C6 HMI LC is designed to don't require touchscreen calibration, but in some cases, like update of the operating system, you must recalibrate the touchscreen.

To calibrate the touchscreen:

- Go in control panel.

Figure 69  
Calibration of the touchscreen

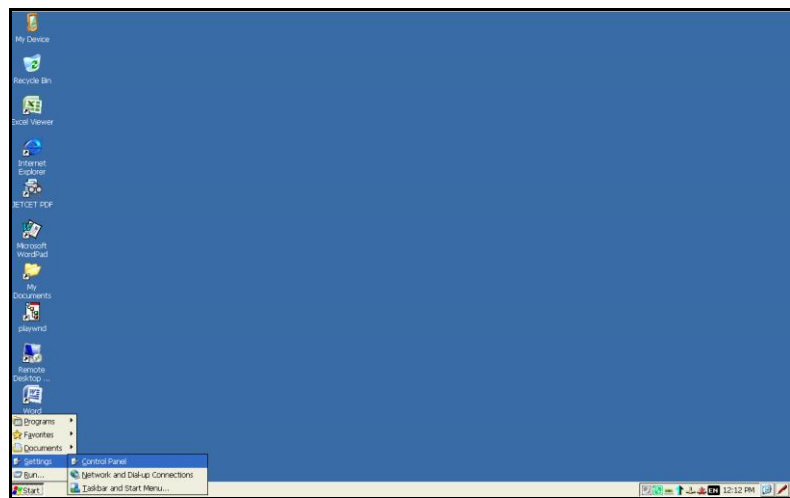

- Open the "Stylus" application.

Figure 70  
Calibration of the touchscreen

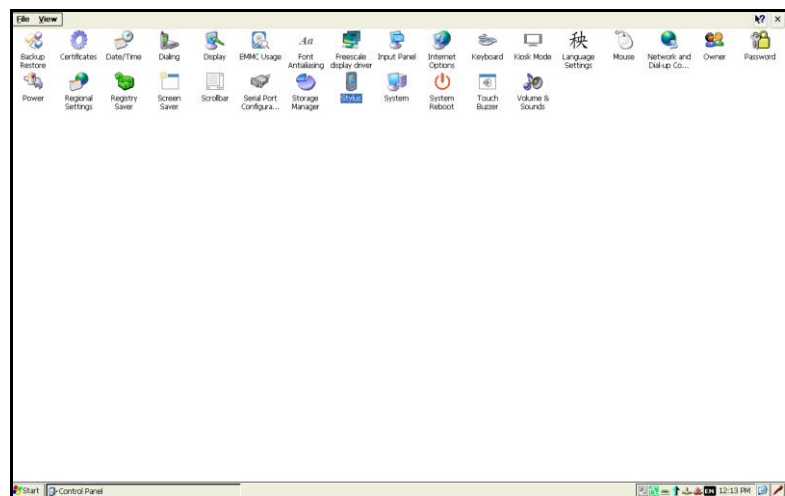
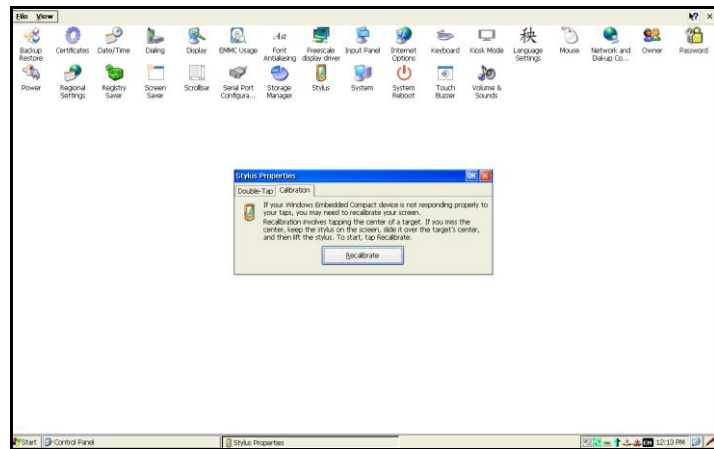

Figure 71  
Calibration of the touchscreen



- Click on the “Recalibrate” button and follow the instructions.

## 7.2 Maintenance & Cleaning

C6 HMI / C6 HMI LC is designed for maintenance-free operation except for the replacing of the battery backup when necessary. It is recommended to clean the touchscreen with a damp cleaning cloth and a display cleaning solution.



Note: clean the front panel of the system with a soft damp cloth only.



Attention: Do not use cleaning agents, solvents, cleaners or objects that could scratch the surface.



Attention: Switch off the device before cleaning.

## 7.2.1 Procedure

Proceed as follows:

- a) Switch off the HMI device or lock the touchscreen.
- b) Spray the cleaning solution onto a cleaning cloth.
- c) Do not spray directly onto the display.
- d) Clean the display from the screen edge inwards.

## 7.2.2 Backup battery replacement (CR2032 3V)

- Remove the two screws as shown in the figure.

Figure 72  
Backup battery replacement



- Remove the two screws as shown in the figure.

Figure 73  
Backup battery replacement



The following figures relate to the display models from 8.4" (inches).

- Remove the two screws as shown in the figure.

Figure 74  
Backup battery replacement

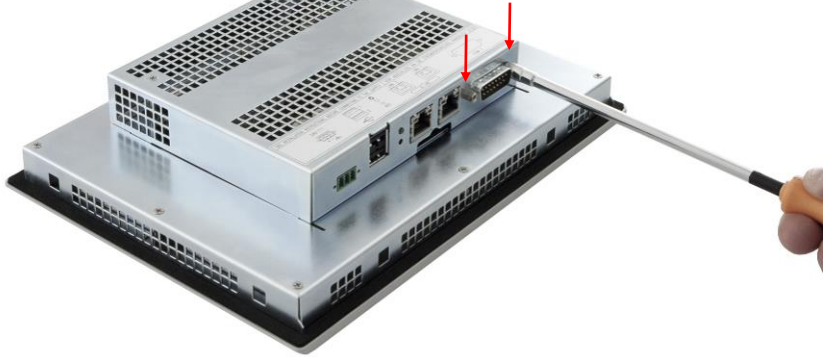

- Remove the two screws as shown in the figure.

Figure 75  
Backup battery replacement

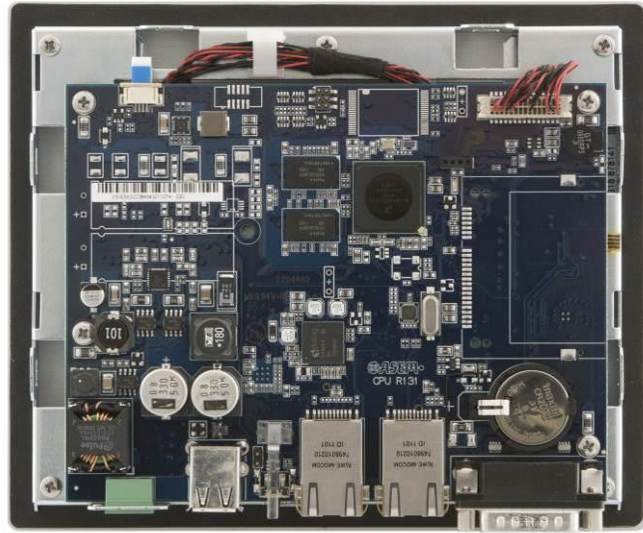

Figure 76  
Backup battery replacement



- Locate the battery position.

*Figure 77*  
Backup battery replacement



- Remove the battery and replace it with one of the same model (CR2032 3V).

*Figure 78*  
Backup battery replacement

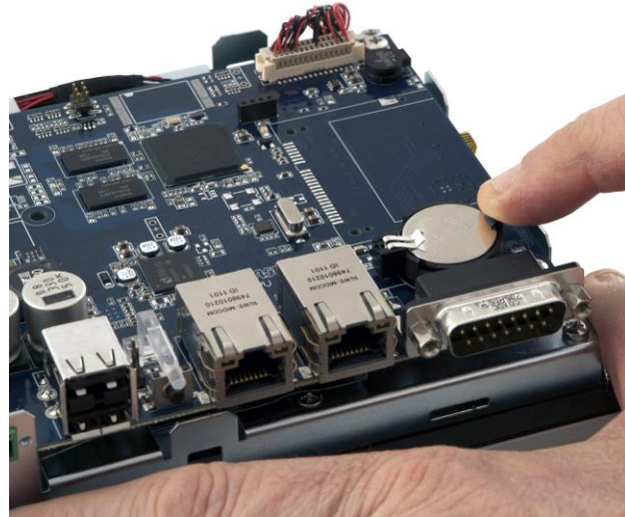

Figure 79  
Backup battery replacement

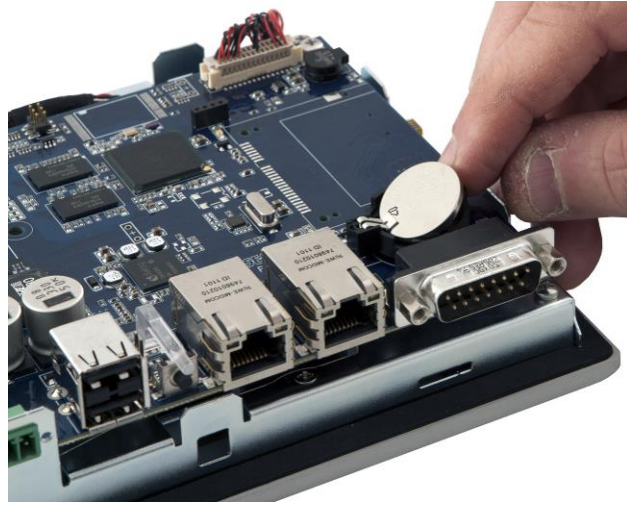

Figure 80  
Backup battery details



### 7.3 Technical support & repairs

KEB offers wide-ranging, complete after-sales technical support. The staff who deal with this handle questions on the entire range of products skilfully, quickly, and efficiently.

You can phone our staff in the service department, and they will give you complete, prompt advice on how to resolve your problems.

Telephone: +49 (0) 5263 401-0  
 Fax: +49 (0) 5263 401-116  
 e-mail: [combicontrol@keb.de](mailto:combicontrol@keb.de)

### 7.4 Recycling and disposal

C6 HMI / C6 HMI LC can be recycled due to the use of materials with low environmental impact. Contact a certified disposal service company for environmentally sound recycling and disposal of your old devices.



**SECTION 8****Technical specifications**

## 8.1 Technical specifications

Table 25  
System software characteristics

<b>System software characteristics</b>		
<b>Integrated system software</b>	Operating System	Microsoft Windows Embedded Compact 7 (C7P)
	HMI	COMBIVIS studio HMI runtimes (Basic, ADVANCED versions)
	Remote control	COMBIVIS connect runtime
	PLC	CONTROL Runtime
<b>COMBIVIS studio HMI characteristics</b>		
		<b>BASIC</b>
		<b>ADVANCED</b>
I/O Bytes (tags)	1,024	4,096
Synoptics	•	•
Graphic libraries	•	•
Power Templates	•	•
Alarms	512	2,048
Accelerators and menus	•	•
Touchscreen	•	•
History Log events	•	•
Dynamic language change	•	•
IL Logic (SoftLogic)	•	•
VBA Multithreading	•	•
ActiveX- OCX	•	•
CFR21 Part 11	•	•
Debugger Online/Remote	•	•
IP camera	•	•
Dynamic trends	•	•
Historical trends, data analysis	•	•
Recipes	•	•
OPC DA Client	•	•
Networking	•	•
Data Loggers	Max 2	•
Text Reports	•	•
Multi drives	Max 2	Max 4
SMS/E-mails	No	•
Webserver	No	2 user
<b>COMBIVIS connect characteristics</b>		
		<b>PRO</b>
Remote desktop		•
File manager		•
Task manager		•
Chat		•
Screenshot		•
VPN with access to remote PC Ethernet subnet		•
VPN up to remote PC		•
Remoted serial (no MPI)		•
API for customer application interface		•
Persistence log on runtime operations		•
Domain creation, user account and remote PC organisation structure		•
Assistance requests reported by runtime		•
Automatic connection		•

Table 26  
MAIN FEATURES of CONTROL PLC  
WinCE/ARM software

<b>MAIN FEATURES of CONTROL PLC WinCE/ARM software</b>		
<b>PLC Programming</b>		COMBIVIS studio 6 Version 6.2.1.0_3.5.3.50
<b>Supported protocols</b>		EtherCAT Master, MODBUS TCP Master, MODBUS RTU Master
<b>Retain variables</b>	Size	64 kB RETAIN + 64 kB PERSISTENT
	Management	Automatic backup of the retain variables on eMMC at every switch-off and/or power supply interruption
<b>Project</b>	Cycle time	≥ 10ms
	Jitter	± 2ms
	CPU occupation	max 25%
	Variable exchanged with PHMI	max suggested 1024
	Datalogging interval	Suggested > 15s
	CONTROL PRO Runtime	No
	S7 MPI COMx	No

Table 27  
System-hardware-characteristics

<b>System-hardware-characteristics</b>		
	4.3"	4-wire – analog - resistive
	5.7"	4-wire – analog - resistive
	7.0"	4-wire – analog - resistive
	8.4"	5-wire – analog - resistive
	10.1" W	5-wire – analog - resistive
	10.4"	5-wire – analog - resistive
	12.1"	5-wire – analog - resistive
	12.1" W	5-wire – analog - resistive
	15.0"	5-wire – analog - resistive
	15.6"	5-wire – analog - resistive
<b>Motherboard</b>	Model:	All-in-one, KEB R131
	RTC	Hardware with battery-backup
	Buzzer	Yes
<b>CPU</b>	Processor	ARM Cortex A8 - Freescale i.MX535 - 1 GHz
	Memory bus	400MHz
<b>Graphic</b>	Controller	GPU with integrated LCD controller
<b>System memory</b>	Type / size / socket	1 GB / DDR3-800 / soldered (contact KEB for different memory options)
<b>Serial interfaces</b>	Type	1 x RS232/422/485 (DB15M) software selectable
	Optoisolation	No
<b>Ethernet interfaces</b>	Type	LAN1 100Mbps (RJ45) with Link/Activity leds LAN2 10/100Mbps (RJ45) with Link/Activity leds
<b>USB interfaces</b>	Type	2 x USB 2.0 (rear, TYPE-A, Host Port, switch off single-channel software)
<b>Storage device</b>	Internal / not removable	<b>NAND-FLASH:</b> 256 MB (Read Only) for operative systems, COMBIVIS studio HMI and COMBIVIS connect. <b>eMMC:</b> 4 GB - 8 bit v. 4.4 compatible (for data and application program)
	External access / removable	SD/SDHC card slot V. 2.0 (push-push Type) (at 4.3" not available)
<b>Battery</b>	Type	Coin (CR2032 3V) removable
	Lifetime	3 years
<b>Buttons, LEDs and keys</b>	Reset button	System
	LEDs	Power / removable disk drive active

Table 28  
Electrical characteristics

<b>Electrical characteristics</b>		
<b>Power supply</b>	Type	integrated on PC board, auto ranging
	Input voltage	18÷36 VDC with 3-pin plug
	Protection	Anti-inversion polarity, overvoltage, soldered fuse on the PC board
	Micro UPS	500ms of back up time after 7 years of life at an average temperature of 45°C First load: 6 min Rearm time: 90 sec
	Power consumption (max.) with USB ports loaded	12.0W@5.7" 13.0W@7.0" 13.5W@8.4" 15.5W@10.4" 19.5W@12.1" (SVGA) 21.5W@15.0" 23.0W@15.6"

*These devices are designed to be connected with a "secondary circuit overvoltage category II".*

Table 29  
Mechanical characteristics

<b>Mechanical characteristics</b>		
<b>Housing</b>	Type	Panel mounting
	Material	Steel, white galvanized
<b>Front panel</b>	Construction	Full aluminium-alloy
	Protection	IP66, enclosure type 4X (INDOOR use only)
	Color	-

Table 30  
Environment characteristics

<b>Environment characteristics</b>		
<b>Temperature</b>	Operation	0° ÷ +50°C
	Storage	-20° ÷ +60°C
<b>Humidity</b>	Operation/storage	80% (non-condensing)

Table 31  
Displays

<b>Displays</b>		
<b>4.3"</b>	LCD size	4.3"
	Resolution	480 x 272
	Colors	16M
	Backlight	Sidelight LED
<b>5.7"</b>	LCD size	5.7"
	Resolution	640 x 480 (VGA)
	Colors	256K
	Backlight	Sidelight LED
<b>7.0" W</b>	LCD size	7" wideband
	Resolution	800 x 480 (WVGA)
	Colors	16M
	Backlight	Sidelight LED
<b>8.4"</b>	LCD size	8.4"
	Resolution	800 x 600 (SVGA)
	Colors	16M
	Backlight	Sidelight LED
<b>10.1" W</b>	LCD size	10.1"
	Resolution	1280x800 (WXGA)
	Colors	16M
	Backlight	Sidelight LED
<b>10.4"</b>	LCD size	10.4"
	Resolution	800 x 600 (SVGA)
	Colors	16M
	Backlight	Sidelight LED
<b>12.1"</b>	LCD size	12.1"
	Resolution	800 x 600 (SVGA)
	Colors	16M
	Backlight	Sidelight LED
<b>12.1" W</b>	LCD size	12.1"
	Resolution	1280x800 (WXGA)
	Colors	16M
	Backlight	Sidelight LED
<b>15.0"</b>	LCD size	15.0"
	Resolution	1024 x 768 (SXGA)
	Colors	16M
	Backlight	Sidelight LED
<b>15.6" W</b>	LCD size	15.6"
	Resolution	1366 x 768 (XGA)
	Colors	16M
	Backlight	Sidelight LED

Table 32  
Guarantee and certifications

<b>Warranty and approvals</b>		
<b>CE</b>	Emission	In accordance with EN 55022 Information technology equipment - radio interferences - max. permissible values and measurement procedures
	Immunity	In accordance with EN 55024 Information technology equipment - noise immunity - max. permissible values and test procedures
	Safety	In accordance with EN 60950-1 – Information technology equipment - Safety - Part 1: General requirements
		Programmable controller 4WZ2 E356364

### 8.1.1 4.3" Display characteristics

Table 33  
4.3" Display characteristics

<b>4.3" Display characteristics</b>	
<b>Dimensions</b>	4.3" (4:3)
<b>Technology</b>	TFT active matrix
<b>Display area</b>	approx. 95.0 (W) x 54.0 (H) mm
<b>Resolution</b>	480 x 272 pixel
<b>Display color</b>	16 M colors
<b>Pixel Pitch</b>	0.198 (W) x 0.198 (H) mm
<b>Luminance</b>	400 cd/m <sup>2</sup> (Note 1)
<b>Horizontal angle (left + right)</b>	130°
<b>Vertical angle (up + down)</b>	90°
<b>Contrast ratio</b>	250:1
<b>Response time (increasing)</b>	40 ms (Type)
<b>Backlight</b>	LED
<b>LED lifetime (Note 2)"</b>	50,000h @ default (Note 3) and max. Tamb

### 8.1.2 5.7" Display characteristics

Table 34  
5.7" Display characteristics

<b>5.7" Display characteristics</b>	
<b>Dimensions</b>	5.7" (4:3)
<b>Technology</b>	TFT active matrix
<b>Display area</b>	115.2 (W) x 86.4 (H) mm
<b>Resolution</b>	640 x 480 pixel
<b>Display color</b>	256 K colors
<b>Pixel Pitch</b>	0.18 (W) x 0.18 (H) mm
<b>Luminance</b>	500 cd/m <sup>2</sup> (Note 1)
<b>Horizontal angle (left + right)</b>	70° + 70°
<b>Vertical angle (up + down)</b>	45° + 55°
<b>Contrast ratio</b>	250:1
<b>Response time (increasing)</b>	50 ms (Type)
<b>Backlight</b>	LED
<b>LED lifetime (Note 2)"</b>	40,000h @ default (Note 3) and max. Tamb

### 8.1.3 7.0"W Display,

Table 35  
7.0"W Display characteristics

<b>7.0"W Display characteristics</b>	
<b>Dimensions</b>	7" wide (15:9)
<b>Technology</b>	TFT active matrix
<b>Resolution</b>	800 x 480 pixel
<b>Display color</b>	16M colors
<b>Pixel Pitch</b>	0.1905 (W) x 0.1905 (H) mm
<b>Luminance</b>	500 cd/m <sup>2</sup> (Note 1)
<b>Horizontal angle (left + right)</b>	70° + 70°
<b>Vertical angle (up + down)</b>	70° + 60°
<b>Contrast ratio</b>	400:1 (Type)
<b>Response time (increasing)</b>	10 ms
<b>Backlight</b>	LED
<b>LED life (Note 2)"</b>	40,000h @ default (Note 3) and max. Tamb

### 8.1.4 8.4" Display characteristics

Table 36  
8.4" Display characteristics

<b>8.4" Display characteristics</b>	
<b>Dimensions</b>	8.4" (4:3)
<b>Technology</b>	TFT active matrix
<b>Display area</b>	170.4 (W) x 127.8 (H) mm
<b>Resolution</b>	800 x 600 pixel
<b>Display color</b>	16M colors
<b>Pixel Pitch</b>	0.213 (W) x 0.213 (H) mm
<b>Luminance</b>	350 cd/m <sup>2</sup> (Note 1)
<b>Horizontal angle (left + right)</b>	75° + 75°
<b>Vertical angle (up + down)</b>	60° + 70°
<b>Contrast ratio</b>	600:1 (Type)
<b>Response time (increasing)</b>	10 ms (Type)
<b>Backlight</b>	LED
<b>LED lifetime (Note 2)"</b>	50,000h @ default (Note 3) and max. Tamb

### 8.1.5 10.1" W Display characteristics

Table 37  
10.1" W Display characteristics

<b>10.1" W Display characteristics</b>	
<b>Dimensions</b>	10.1" W (16:10)
<b>Technology</b>	TFT active matrix
<b>Display area</b>	216.96 x 135.6
<b>Resolution</b>	1280 x 800 pixel
<b>Display color</b>	16M colors
<b>Pixel Pitch</b>	0.1695 (W) x 0.1695 (H) mm
<b>Luminance</b>	400 cd/m <sup>2</sup>
<b>Horizontal angle (left + right)</b>	85° + 85°
<b>Vertical angle (up + down)</b>	85° + 85°
<b>Contrast ratio</b>	800:1
<b>Response time (increasing)</b>	25 ms
<b>Backlight</b>	LED
<b>LED lifetime (Note 2)"</b>	100,000h

### 8.1.6 10.4" Display characteristics

Table 38  
10.4" Display characteristics

<b>10.4" Display characteristics</b>	
<b>Dimensions</b>	10.4" (4:3)
<b>Technology</b>	TFT active matrix
<b>Display area</b>	211.2 (W) x 158.4 (H) mm
<b>Resolution</b>	800 x 600 pixel
<b>Display color</b>	16M colors
<b>Pixel Pitch</b>	0.264 (W) x 0.264 (H) mm
<b>Luminance</b>	400 cd/m <sup>2</sup> (Note 1)
<b>Horizontal angle (left + right)</b>	80° + 80°
<b>Vertical angle (up + down)</b>	60° + 80°
<b>Contrast ratio</b>	700:1 (Type)
<b>Response time (increasing)</b>	20 ms (Type)
<b>Backlight</b>	LED
<b>LED lifetime (Note 2)"</b>	50,000h @ default (Note 3) and max. Tamb

### 8.1.7 12.1" (SVGA) display characteristics

Table 39  
12.1" (SVGA) Display characteristics

<b>12.1" Display characteristics</b>	
<b>Dimensions</b>	12.1" (4:3)
<b>Technology</b>	TFT active matrix
<b>Display area</b>	246.0 (W) x 184.5 (H) mm
<b>Resolution</b>	800 x 600 pixel
<b>Display color</b>	16M colors
<b>Pixel Pitch</b>	0.3075 (W) x 0.3075 (H) mm
<b>Luminance</b>	500 cd/m <sup>2</sup> (Note 1)
<b>Horizontal angle (left + right)</b>	80° + 80°
<b>Vertical angle (up + down)</b>	70° + 70°
<b>Contrast ratio</b>	800:1 (Type)
<b>Response time (increasing)</b>	4 ms (Type)
<b>Backlight</b>	LED
<b>LED lifetime (Note 2)"</b>	100,000h @ default (Note 3) and max. Tamb

## 12.1" W display characteristics

Table 40  
12.1" W Display characteristics

<b>12.1" W Display characteristics</b>	
<b>Dimensions</b>	12.1" (16:10)
<b>Technology</b>	TFT active matrix
<b>Display area</b>	261.12 x 163.2
<b>Resolution</b>	1280 x 800 pixel
<b>Display color</b>	16M colors
<b>Pixel Pitch</b>	0.204 (W) x 0.204 (H) mm
<b>Luminance</b>	400 cd/m <sup>2</sup>
<b>Horizontal angle (left + right)</b>	88° + 88°
<b>Vertical angle (up + down)</b>	88° + 88°
<b>Contrast ratio</b>	1000:1
<b>Response time (increasing)</b>	25 ms
<b>Backlight</b>	LED
<b>LED lifetime (Note 2)"</b>	50,000 h

## 8.1.8 15.0" Display characteristics

Table 41  
15.0" Display characteristics

<b>15.0" Display characteristics</b>	
<b>Dimensions</b>	15.0" (4:3)
<b>Technology</b>	TFT active matrix
<b>Display area</b>	304.1 (W) x 228.1 (H) mm
<b>Resolution</b>	1024 x 768 pixel
<b>Display color</b>	16M colors
<b>Pixel Pitch</b>	0.297 (W) x 0.297 (H) mm
<b>Luminance</b>	450 cd/m <sup>2</sup> (Note 1)
<b>Horizontal angle (left + right)</b>	80° + 80°
<b>Vertical angle (up + down)</b>	70° + 70°
<b>Contrast ratio</b>	700:1 (Type)
<b>Response time (increasing)</b>	2 ms (Type)
<b>Backlight</b>	LED
<b>LED lifetime (Note 2)"</b>	100,000h @ default (Note 3) and max. Tamb

## 8.1.9 15.6" W Display characteristics

Table 42  
15.6" W Display characteristics

<b>15.6" W Display characteristics</b>	
<b>Dimensions</b>	15.6" (16:9)
<b>Technology</b>	TFT active matrix
<b>Display area</b>	344.2 (W) x 193.5 (H) mm
<b>Resolution</b>	1366 x 768 pixels
<b>Display color</b>	16.7M colors
<b>Pixel Pitch</b>	0.252 (W) x 0.252 (H) mm
<b>Luminance</b>	300 cd/m <sup>2</sup> (Note 1)
<b>Horizontal angle (left + right)</b>	85°+85°
<b>Vertical angle (up + down)</b>	80°+80°
<b>Contrast ratio</b>	500:1 (Typ.)
<b>Response time (increasing)</b>	8 ms (Type)
<b>Backlight</b>	LED
<b>LED life (Note 2)</b>	50,000h @ default (Note 3) and max Tamb



Note 1 At maximum (100%) brightness setting.

Note 2 After the LED life time, the backlight luminance may be reduced up to the 50% of the initial value.

Note 3 The default backlight value is set at 80% of the maximum brightness by the operating system.  
Note that the user can modify the backlight brightness, using the related operating system mask.  
At 25°C, the above-indicated LED life is also guaranteed at 100% backlight brightness; instead, at higher ambient temperature and 100% backlight brightness, LED life time will decrease.



## 8.2 Certificates and approvals

<b>Warranty and approvals</b>		
	Emission	Conforms to: EN 55022 Information technology equipment – Radio disturbance characteristics EN 61000-3-2 Limits for harmonic current emissions EN 61000-3-3 Limitation of voltage fluctuation flicker EMC Directive 2014/30/EU ex 2004/108/EC
	Immunity	Conforms to: EN 55024 Information technology equipment – Immunity characteristics EN 61000-6-2 Electromagnetic compatibility (EMC) - Part 6-2: Generic standards - Immunity for industrial environments EMC Directive 2014/30/EU ex 2004/108/EC
	Safety	Conforms to: EN 60950-1 – Information technology equipment – Safety
	Conforms to: EN 50581:2012 - Technical documentation for the assessment of electrical and electronic products with respect to the restriction of hazardous substances RoHS Directive 2011/65/EU	
	Industrial Control Equipment, UL508 Process Control Equipment Industrial Products, CAN/CSA C22.2 No. 142-M1987	

## 8.3 Ports PINOUT

### 8.3.1 COM1 – DB15M Serial

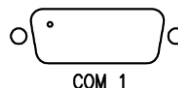

<i>PIN</i>	<i>Signal</i>	<i>Input/output</i>
1	+5 VDC	OUT
2	Transmission data (RS-232)	OUT
3	Received data (RS-232)	IN
4	Transmit To Send	OUT
5	Clear Tu Send	IN
6	Data set ready	IN
7	Ground	—
8	Data Terminal Ready	OUT
9	Carrier Detect	IN
10	Transmission Data +/Receive Data + (RS-485/RS-422)	Input/output
11	Transmission Data -/Receive Data - (RS-485/RS-422)	I/O
12	Ring Indication (RS-232)	IN
13	Receive Data + (RS-422)	IN
14	Receive Data - (RS-422)	IN
15	N.C.	N.C.



Any polarization or termination resistor is connected to RS422/485 channel so, if required, it has to be provided by the user into the plant connector.

### 8.3.2 LAN1 – LAN2

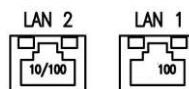

<i>PIN</i>	<i>Signal</i>
1	TX+
2	TX-
3	RX+
4	Shield
5	Shield
6	RX-
7	Shield
8	Shield

### 8.3.3 USB1 / USB2

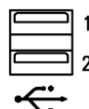

<i>PIN</i>	<i>Signal</i>
1	+5 Vcc
2	USB data -
3	USB data +
4	GND

## Figure overview

Figure 1 C6 HMI / C6 HMI LC 5.7" .....	12
Figure 2 Aluminium front panel details .....	12
Figure 3 Aluminium front panel details .....	13
Figure 4 C6 HMI 4.3" rear view .....	14
Figure 5 C6 HMI / C6 HMI LC 5.7" rear view .....	14
Figure 6 C6 HMI / C6 HMI LC 7.0" rear view .....	14
Figure 7 C6 HMI / C6 HMI LC 8.4" rear view .....	15
Figure 8 C6 HMI 4.3" side view .....	16
Figure 9 C6 HMI 4.3" side view .....	16
Figure 10 C6 HMI / C6 HMI LC 5.7" side view .....	17
Figure 11 C6 HMI / C6 HMI LC 5.7" side view .....	17
Figure 12 C6 HMI 4.3" connections .....	18
Figure 13 C6 HMI / C6 HMI LC Labelling of the labels .....	18
Figure 14 C6 HMI / C6 HMI LC 5.7" connectors .....	19
Figure 15 C6 HMI / C6 HMI LC Labelling of the labels .....	19
Figure 16 C6 HMI / C6 HMI LC nameplate details .....	20
Figure 17 Configuration and project creation .....	21
Figure 18 Process management .....	21
Figure 19 Mounting position .....	26
Figure 20 Installation distances .....	27
Figure 21 Installation .....	31
Figure 22 Installation .....	31
Figure 23 Installation .....	32
Figure 24 Installation .....	32
Figure 25 Installation .....	32
Figure 26 Installation .....	33
Figure 27 Installation .....	33
Figure 28 Power supply connection detail .....	34
Figure 29 Power supply connection details .....	35
Figure 30 Power supply connection details .....	35
Figure 31 Connecting the configuration PC .....	36
Figure 32 Connecting the configuration PC .....	37
Figure 33 Connecting the configuration PC .....	37
Figure 34 Connecting the configuration PC .....	38
Figure 35 Connecting the configuration PC .....	38
Figure 36 Connecting the configuration PC .....	39
Figure 37 Connecting the configuration PC .....	39
Figure 38 Connecting the configuration PC .....	40
Figure 39 Commissioning the device .....	42
Figure 40 Slot for memory card .....	43
Figure 41 Slot for memory card .....	43
Figure 42 Slot for memory card .....	43
Figure 43 Slot for memory card .....	44
Figure 44 Slot for memory card .....	44
Figure 45 Slot for memory card .....	44
Figure 46 Configuring the serial port .....	47
Figure 47 Configuring the serial port .....	47
Figure 48 Configuring the serial port .....	47
Figure 49 Configuring the serial port .....	48
Figure 50 Stop running project .....	49
Figure 51 Picture Stop running project .....	49
Picture 52 Starting the project .....	50
Figure 53 Debugging the project .....	51
Figure 54 Debugging the projects .....	52
Figure 55 Debugging the project .....	52
Figure 56 Debugging the project .....	53

Figure 57 Debug the project.....	54
Figure 58 Start CDSlaunchMgr.exe.....	60
Figure 59 CDS Launch-Manager.....	60
Figure 60 System-Manager system control applets.....	65
Figure 61 Backup Restore.....	66
Figure 62 Font Antialiasing.....	70
Figure 63 EMMC Usage.....	70
Figure 64 Kiosk Mode.....	71
Figure 65 Launch Explorer of COMBIVIS studio HMI.....	72
Figure 66 Language settings.....	72
Figure 67 Configure Scrollbar.....	73
Figure 68 System Reboot.....	73
Figure 69 Calibration of the touchscreen.....	75
Figure 70 Calibration of the touchscreen.....	75
Figure 71 Calibration of the touchscreen.....	76
Figure 72 Backup battery replacement.....	77
Figure 73 Backup battery replacement.....	77
Figure 74 Backup battery replacement.....	78
Figure 75 Backup battery replacement.....	78
Figure 76 Backup battery replacement.....	78
Figure 77 Backup battery replacement.....	79
Figure 78 Backup battery replacement.....	79
Figure 79 Backup battery replacement.....	80
Figure 80 Backup battery details.....	80

## Table overview

Table 1 Packaging.....	11
Table 2 Touchscreen.....	20
Table 3 Software options.....	22
Table 4 Graphic interface.....	22
Table 5 Alarm log.....	22
Table 6 Recipes –Data loggers.....	22
Table 7 Trends.....	22
Table 8 Users & passwords.....	22
Table 9 Dynamic multilanguage.....	23
Table 10 Drivers.....	23
Table 11 Event object.....	23
Table 12 Scaling object.....	23
Table 13 Scheduler object.....	23
Table 14 Logics.....	23
Table 15 Networking.....	23
Table 16 Child Projects.....	23
Table 17 Software options.....	23
Table 18 Visual studio source safe 2005 integration.....	23
Table 19 Web server.....	23
Table 20 Touchscreen support.....	23
Table 21 Cross reference.....	23
Table 22 Debugger.....	23
Table 23 Connecting the configuration PC.....	36
Table 24 Procedure.....	40
Table 25 System software characteristics.....	82
Table 26 MAIN FEATURES of CONTROL PLC WinCE/ARM software.....	83
Table 27 System-hardware-characteristics.....	83
Table 28 Electrical characteristics.....	84
Table 29 Mechanical characteristics.....	84
Table 30 Environment characteristics.....	84
Table 31 Displays.....	85
Table 32 Guarantee and certifications.....	85
Table 33 4.3" Display characteristics.....	86
Table 34 5.7" Display characteristics.....	86
Table 35 7.0"W Display characteristics.....	86
Table 36 8.4" Display characteristics.....	86
Table 37 10.1"W Display characteristics.....	87
Table 38 10.4" Display characteristics.....	87
Table 39 12.1" (SVGA) Display characteristics.....	87
Table 40 12.1"W Display characteristics.....	88
Table 41 15.0" Display characteristics.....	88
Table 42 15.6"W Display characteristics.....	88



**Benelux** | KEB Automation KG

Dreef 4 - box 4 1703 Dilbeek Belgien

Tel: +32 2 447 8580

E-Mail: [info.benelux@keb.de](mailto:info.benelux@keb.de) Internet: [www.keb.de](http://www.keb.de)**Brasilien** | KEB SOUTH AMERICA - Regional Manager

Rua Dr. Omar Pacheco Souza Riberio, 70

CEP 13569-430 Portal do Sol, São Carlos Brasilien

Tel: +55 16 31161294 E-Mail: [roberto.arias@keb.de](mailto:roberto.arias@keb.de)**China** | KEB Power Transmission Technology (Shanghai) Co. Ltd.

No. 435 QianPu Road Chedun Town Songjiang District

201611 Shanghai P. R. China

Tel: +86 21 37746688 Fax: +86 21 37746600

E-Mail: [info@keb.cn](mailto:info@keb.cn) Internet: [www.keb.cn](http://www.keb.cn)**Deutschland** | **Getriebemotorenwerk**

KEB Antriebstechnik GmbH

Wildbacher Straße 5 08289 Schneeberg Deutschland

Telefon +49 3772 67-0 Telefax +49 3772 67-281

Internet: [www.keb-drive.de](http://www.keb-drive.de) E-Mail: [info@keb-drive.de](mailto:info@keb-drive.de)**Frankreich** | Société Française KEB SASU

Z.I. de la Croix St. Nicolas 14, rue Gustave Eiffel

94510 La Queue en Brie Frankreich

Tel: +33 149620101 Fax: +33 145767495

E-Mail: [info@keb.fr](mailto:info@keb.fr) Internet: [www.keb.fr](http://www.keb.fr)**Großbritannien** | KEB (UK) Ltd.

5 Morris Close Park Farm Industrial Estate

Wellingborough, Northants, NN8 6 XF Großbritannien

Tel: +44 1933 402220 Fax: +44 1933 400724

E-Mail: [info@keb.co.uk](mailto:info@keb.co.uk) Internet: [www.keb.co.uk](http://www.keb.co.uk)**Italien** | KEB Italia S.r.l. Unipersonale

Via Newton, 2 20019 Settimo Milanese (Milano) Italien

Tel: +39 02 3353531 Fax: +39 02 33500790

E-Mail: [info@keb.it](mailto:info@keb.it) Internet: [www.keb.it](http://www.keb.it)**Japan** | KEB Japan Ltd.

15 - 16, 2 - Chome, Takawawa Minato-ku Tokyo 108 - 0074 Japan

Tel: +81 33 445-8515 Fax: +81 33 445-8215

E-Mail: [info@keb.jp](mailto:info@keb.jp) Internet: [www.keb.jp](http://www.keb.jp)**Österreich** | KEB Automation GmbH

Ritzstraße 8 4614 Marchtrenk Österreich

Tel: +43 7243 53586-0 Fax: +43 7243 53586-21

E-Mail: [info@keb.at](mailto:info@keb.at) Internet: [www.keb.at](http://www.keb.at)**Polen** | KEB Automation KG

Tel: +48 60407727

E-Mail: [roman.trinczek@keb.de](mailto:roman.trinczek@keb.de) Internet: [www.keb.de](http://www.keb.de)**Russische Föderation** | KEB RUS Ltd.

Lesnaya str, house 30 Dzerzhinsky MO

140091 Moscow region Russische Föderation

Tel: +7 495 6320217 Fax: +7 495 6320217

E-Mail: [info@keb.ru](mailto:info@keb.ru) Internet: [www.keb.ru](http://www.keb.ru)**Schweiz** | KEB Automation AG

Witzbergstraße 24 8330 Pfäffikon/ZH Schweiz

Tel: +41 43 2886060 Fax: +41 43 2886088

E-Mail: [info@keb.ch](mailto:info@keb.ch) Internet: [www.keb.ch](http://www.keb.ch)**Spanien** | KEB Automation KG

c / Mitjer, Nave 8 - Pol. Ind. LA MASIA

08798 Sant Cugat Sessgarrigues (Barcelona) Spanien

Tel: +34 93 8970268 Fax: +34 93 8992035

E-Mail: [vb.espana@keb.de](mailto:vb.espana@keb.de)**Südkorea** | KEB Automation KG

Deoksan-Besttel 1132 ho Sangnam-ro 37

Seongsan-gu Changwon-si Gyeongsangnam-do Republik Korea

Tel: +82 55 601 5505 Fax: +82 55 601 5506

E-Mail: [jaeok.kim@keb.de](mailto:jaeok.kim@keb.de) Internet: [www.keb.de](http://www.keb.de)**Tschechien** | KEB Automation GmbH

Videnska 188/119d 61900 Brno Tschechien

Tel: +420 544 212 008

E-Mail: [info@keb.cz](mailto:info@keb.cz) Internet: [www.keb.cz](http://www.keb.cz)**USA** | KEB America, Inc

5100 Valley Industrial Blvd. South Shakopee, MN 55379 USA

Tel: +1 952 2241400 Fax: +1 952 2241499

E-Mail: [info@kebameric.com](mailto:info@kebameric.com) Internet: [www.kebameric.com](http://www.kebameric.com)**WEITERE KEB PARTNER WELTWEIT:**... [www.keb.de/de/kontakt/kontakt-weltweit](http://www.keb.de/de/kontakt/kontakt-weltweit)



**Automation mit Drive**

**[www.keb.de](http://www.keb.de)**

KEB Automation KG Südstraße 38 32683 Bartrup Tel. +49 5263 401-0 E-Mail: [info@keb.de](mailto:info@keb.de)