



Functional safety

Functional safety

Safety module Type 3

SAFETY MANUAL | Firmware – V3.2.0.1

Translation of the original manual
Document 20148769 EN 07







1 Preface

The described hardware and software are developments of the KEB Automation KG. The enclosed documents correspond to conditions valid at printing. Misprint, mistakes and technical changes reserved.

1.1 Signal words and symbols

Certain operations can cause hazards during the installation, operation or thereafter. There are safety informations in the documentation in front of these operations. Security signs are located on the device or machine. A warning contains signal words which are explained in the following table:

	➤ Dangerous situation, which will cause death or serious injury in case of non-observance of this safety instruction.
	➤ Dangerous situation, which may cause death or serious injury in case of non-observance of this safety instruction.
	➤ Dangerous situation, which may cause minor injury in case of non-observance of this safety instruction.
	➤ Situation, which can cause damage to property in case of non-observance.

RESTRICTION

Is used when certain conditions must meet the validity of statements or the result is limited to a certain validity range.



- Is used when the result will be better, more economic or trouble-free by following these procedures.

1.2 More symbols

- ▶ This arrow starts an action step.
- /- Enumerations are marked with dots or indents.
- => Cross reference to another chapter or another page.

	<p>Note to further documentation.</p> <p>Search for documents at www.keb.de</p>	
---	---	---



1.3 Laws and guidelines

KEB Automation KG confirms with the CE mark and the EC declaration of conformity, that our device complies with the essential safety requirements.

The CE mark is located on the name plate. The EC declaration of conformity can be downloaded on demand via our website. Further information is provided in chapter 16 „Annex to the declaration of conformity“.

1.4 Warranty

The warranty for design, material or processing defects for the acquired device can be found in the "General Sales Conditions".

	<p>Here you will find our general sales conditions.</p> <p>https://www.keb.de/terms-and-conditions</p>	
---	--	---

Further agreements or specifications require a written confirmation.

1.5 Support

Through multiple applications not every imaginable case has been taken into account. If you require further information or if problems occur which are not treated detailed in the documentation, you can request the necessary information via the local agency.

The use of our units in the target products is beyond of our control and therefore exclusively the responsibility of the machine manufacturer, system integrator or customer.

The information contained in the technical documentation, as well as any user-specific advice in spoken and written and through tests, are made to best of our knowledge and information about the application. However, they are considered for information only without responsibility. This also applies to any violation of industrial property rights of a third-party.

Selection of our units in view of their suitability for the intended use must be done generally by the user.

Tests can only be done within the application by the machine manufacturer. They must be repeated, even if only parts of hardware, software or the unit adjustment are modified.

1.6 Copyright

The customer may use the instruction manual as well as further documents or parts from it for internal purposes. Copyrights are with KEB Automation KG and remain valid in its entirety.

Other wordmarks or/and logos are trademarks (™) or registered trademarks (®) of their respective owners and are listed in the footnote on the first occurrence.

Content

1	Preface	3
1.1	Signal words and symbols.....	3
1.2	More symbols	3
1.3	Laws and guidelines	4
1.4	Warranty.....	4
1.5	Support	4
1.6	Copyright	4
2	Basic Safety Instructions	12
2.1	Target group	12
2.2	Validity of this manual	12
2.3	Electrical connection	13
2.4	Installation	13
2.5	Start-up and operation	14
2.6	Maintenance	14
3	Product description	15
3.1	Validity	15
3.2	Function	15
3.3	Safety functions according to IEC 61800-5-2.....	15
3.4	Classification of the safety functions according to IEC 61508	16
3.5	Classification of the safety functions according to EN ISO 13849	16
3.6	Safe condition	17
3.7	Used terms and abbreviations.....	17
4	Description of the I/Os.....	19
4.1	Terminal X2B	19
4.1.1	Assembly of the wires	19
4.1.2	Assembly of connecting wires with wire-end ferrules according to DIN46228/4	20
4.1.3	Assembly of connecting wires without wire-end ferrules	20
4.1.4	Specification of the inputs	20
4.1.5	Specification of the outputs.....	20
4.2	Terminals brake.....	20
4.3	Terminal encoder interface	20
4.4	Status LEDs	21
5	Parameterization and user management	22
5.1	User management and login.....	23
5.2	Safe configuration of parameters of the safety module	25
5.2.1	Download of new configuration data.....	26
5.2.2	Read out of existing configuration information from the safety module	26
5.2.3	Import and export of configuration data	26
5.2.4	Export of safe parameter data	26
5.2.5	Import of safe parameter data.....	27
5.2.6	Generate parameter list for download	27
5.2.7	Import safe parameter data from parameter list	27
5.3	Status of the safety module	28
5.4	Read out of the log data	30

5.4.1	Read out of errors	30
5.4.2	Read out of switch-on sequences.....	30
5.4.3	Read out of switch-off sequences.....	31
5.4.4	Read out of requests for safety functions	31
5.4.5	Read out of the time to assume new configuration data	31
5.4.6	Read out of configuration errors	32
5.4.7	Read out of bus errors	32
5.4.8	Read out of bus configuration errors.....	32
5.4.9	Bus request of safety functions.....	33
5.5	Parameter List	34
6	Operating condition of the safety module	42
6.1	Global operating condition	42
6.2	Start of the safety module and transfer of new configuration data	43
6.3	Error reset.....	45
7	Configuration state and configuration transfer	46
7.1	Configuration state	46
7.2	Create configuration data for different machines	47
8	Input configuration and input parameter	48
8.1	Filter time for the safety inputs	48
8.2	Clock signal input configuration for all inputs	48
8.3	STO hardware input configuration.....	50
8.4	SBC hardware input configuration.....	52
8.5	Function1 hardware input configuration	54
8.6	Function2 hardware input configuration	56
8.7	Ripple hardware input configuration	59
9	Outputs.....	61
9.1	Safe output 1 & 2.....	61
9.2	Ripple outputs	62
9.3	Clock-output.....	64
9.3.1	Clock output configuration	64
9.3.2	Recommended adjustments for the cycle duration of the clock outputs	64
10	Encoder configuration.....	65
10.1	Encoder selection	65
10.2	Use sine/cosine encoder	66
10.3	Use of resolvers	67
10.3.1	maximum permissible speed	67
10.3.2	Phase shifting of the signals	67
10.3.3	Position error.....	67
10.4	Scaling settings for the position, encoder settings for the input channels	68
10.5	Encoder settings for speed detection.....	68
10.5.1	Speed scan time	69
10.5.2	Speed PT1 time	69
10.5.3	Speed scan time + speed PT1-time.....	70
11	Functional description of the safety functions.....	71
11.1	Priority of the safety functions	71
11.2	Status of the safety module	71
11.3	Functional description Safe Torque Off (STO)	72

11.3.1	Emergency stop in accordance with EN 60204	72
11.3.2	Error response times STO function.....	73
11.4	Functional description Safe Brake Control (SBC).....	74
11.4.1	Requirements for the brake	74
11.4.2	Error response times SBC function.....	75
11.4.3	Setting of status bits by the SBC function.....	75
11.4.4	Monitoring of the SBC function	75
11.4.5	Configuration parameter of the safety function SBC	76
11.5	Functional description Safe Stop 1 (SS1)	77
11.5.1	Activation of the safety function SS1	77
11.5.2	Configuration parameters of the safety function SS1	77
11.5.3	Error response times SS1 function	77
11.5.4	Emergency stop in accordance with EN 60204	78
11.5.5	Description of the SS1-r function	78
11.5.6	Description of the SS1-t function	82
11.6	Functional description safe stop 2 (SS2)	83
11.6.1	Activation of the safety function SS1	83
11.6.2	Configuration parameters of the safety function SS2	83
11.6.3	Error response times SS1 function	83
11.6.4	Description of the SS2-r function	84
11.6.5	Description of the SS2-t function	87
11.7	Functional description Safe Operating Stop (SOS).....	88
11.7.1	Activation of the safety function SOS	88
11.7.2	Configuration parameters of the safety function SOS	89
11.7.3	Error response time SOS function	89
11.8	Functional description Safely-Limited Speed (SLS)	90
11.8.1	Activation of the safety function SLS	90
11.8.2	Configuration parameters of the safety function SLS	90
11.8.3	Error response times SLS function	91
11.9	Functional description SLP: Reference position.....	92
11.9.1	Activation of the function SLP reference position	92
11.9.2	Configuration parameter SLP reference position.....	93
11.10	Functional description safely limited position (SLP)	93
11.10.1	Functional description Safe Emergency Limits (SEL).....	94
11.10.2	Activation of the safety function SLP	94
11.10.3	Configuration parameters of the safety function SLP	95
11.10.4	Error response times SLP function	95
11.11	Functional description Safely-Limited Increment (SLI)	95
11.11.1	Activation of the safety function SLI.....	97
11.11.2	Configuration of the SLI function.....	97
11.11.3	Error response times SLI function.....	98
11.12	Functional description Safe Direction (SDI).....	98
11.12.1	Activation of the safety function SDI	98
11.12.2	Configuration of the SDI function	98
11.12.3	Error response times SDI function	99
11.13	Functional description Safe Speed Monitor (SSM)	99
11.13.1	Activation of the safety function SSM	99
11.13.2	Configuration of the SSM function	100

11.13.3 Error response times SSM function	100
11.14 Functional description safe maximum speed (SMS).....	101
11.14.1 Activation of the safety function SMS	101
11.14.2 Configuration parameters of the safety function SMS	102
11.14.3 Error response times SMS function	102
11.15 Functional description Safe Limited Acceleration (SLA)	103
11.15.1 Acceleration limits	103
11.15.2 Activation of the safety function SLA	104
11.15.3 Configuration parameter of the safety function SLA	104
11.15.4 Error response times SLA function	104
12 Safety over EtherCAT® (FSoE).....	106
12.1 Setting the fieldbus address.....	106
12.2 FSoE bus settings.....	106
12.3 FSoE functional description and parameterization	106
13 Wiring Examples.....	107
13.1 Example of a wiring of clock outputs with inputs	107
13.1.1 Parameterisation of the clock outputs and inputs	107
13.2 Example of a ripple chain.....	109
13.2.1 Closed ripple chain with 2 safety modules start-up behaviour	109
13.2.2 Closed ripple chain with 3 safety modules.....	110
13.3 Circuit example with STO, SS1 and SS2 and ripple chain.....	111
13.3.1 Parameterization for COMBIVERT FB	111
13.3.2 Parameterization for the COMBIVERT B1X	112
13.3.3 Parameterization for the COMBIVERT B1Y	112
13.3.4 Parameterization for the COMBIVERT B1Z	113
13.3.5 Parameterization for the COMBIVERT B2X	114
13.3.6 Parameterization for the COMBIVERT B2Y	114
14 Acceptance tests and configuration check	116
14.1 Sense of the acceptance tests.....	116
14.2 Inspector	116
14.3 Protocol of the acceptance test.....	116
14.4 Execution of the acceptance test and scope of the audit	116
15 Maintenance and modifications at the safety module	117
16 Annex to the declaration of conformity	118
17 Revision history.....	120

Figures

Figure 1: Assembly of the terminal X2B.....	19
Figure 2: Add KEB safety module.....	22
Figure 3: User management in KEB COMBIVIS.....	23
Figure 4: Login window in COMBIVIS.....	23
Figure 5: User management for the safety module in COMBIVIS.....	24
Figure 6: Safe configuration of the parameters of the safety module.....	25
Figure 7: Tool tip for the parameter configuration of the ripple input.....	25
Figure 8: Import and export of configuration data.....	26
Figure 9: "Unlock" after the import of configuration information.....	27
Figure 10: Status tab in the KEB safety editor.....	28
Figure 11: Error state with error description in COMBIVIS.....	29
Figure 12: Error time, error number and description.....	30
Figure 13: Switch-on sequences with date and time in log.....	30
Figure 14: Switch-off sequences with date and time in log.....	31
Figure 15: Request times of safety functions.....	31
Figure 16: Transfer times of new configuration data.....	31
Figure 17: Time, error number and description of configuration errors.....	32
Figure 18: Bus error with date and time in log.....	32
Figure 19: Bus configuration errors with date and time in log.....	32
Figure 20: Bus request of safety functions in log.....	33
Figure 21: The global status of the safety module.....	42
Figure 22: Booting the safety module.....	44
Figure 23: Configuration state of the safety module.....	46
Figure 24: Safety module address in the configuration data.....	47
Figure 25: Filter time for the safety inputs (input configuration).....	48
Figure 26: Clock signal input configuration for the safety inputs.....	48
Figure 27: Parameters for the STO safety input.....	50
Figure 28: Parameters for the SBC safety input.....	52
Figure 29: Parameters for the function 1 input.....	54
Figure 30: Parameters for the function2 input.....	56
Figure 31: Parameter for the ripple input.....	59
Figure 32: Parameters of the output configuration.....	61
Figure 33: Ripple output configuration settings.....	62
Figure 34: Clock output configuration in COMBIVIS.....	64
Figure 35: General encoder configuration.....	65
Figure 36: Encoder configuration in COMBIVIS.....	66
Figure 37: Encoder settings for the input channels.....	68
Figure 38: Encoder settings for speed measurement.....	68
Figure 39: Speed scan time related to the speed.....	69
Figure 40: Speed PT1-time related to a speed jump.....	70
Figure 41: Speed scan time and speed PT1 time together.....	70
Figure 42: SBC Parameters.....	76
Figure 43: Configuration parameter for the safety function SS1.....	77
Figure 44: SS1-r safety function.....	78
Figure 45: SS1-r with negative speed as starting value.....	79
Figure 46: SS1-r Safety function with higher deceleration permissible.....	79
Figure 47: SS1-r Safety function with faulty ramp.....	81
Figure 48: SS1-t Functional description.....	82
Figure 49: Configuration parameters for the safety function SS2.....	83
Figure 50: SS2-r safety function.....	84
Figure 51: SS2-r safety function with negative speed.....	84
Figure 52: SS2-r safety function with higher deceleration permissible.....	85
Figure 53: SS2-r safety function with faulty ramp.....	86

Figure 54: SS2-t function	87
Figure 55: SOS safety function	88
Figure 56: Configuration parameters for the safety function SOS	89
Figure 57: Safely limited speed - SLS	90
Figure 58: Configuration parameters for the safety function SLS	90
Figure 59: SLP Reference position	92
Figure 60: Configuration parameter of the function SLP reference position	93
Figure 61: Safely-Limited Position – SLP)	93
Figure 62: Safe Emergency Limits (SEL)	94
Figure 63: Configuration parameters for the safety function SLP	95
Figure 64: Safely-Limited Increment – SLI	96
Figure 65: Configuration parameters for the safety function SLI	97
Figure 66: Configuration parameters for the safety function SDI	98
Figure 67: Safe Speed Monitor – SSM)	99
Figure 68: Configuration parameters for die safety function SSM	100
Figure 69: Safe Maximum Speed - SMS	101
Figure 70: Configuration parameters for the safety function SMS	102
Figure 71: Safe maximum acceleration - SLA	103
Figure 72 Log entries for the SLA safety function	104
Figure 73: Configuration parameters for the safety function SLA	104
Figure 74: Safety module address in the configuration	106
Figure 75: Clock outputs wired with inputs	107
Figure 76: Test pulses of the clock outputs	107
Figure 77: Configuration of the clock signal inputs	108
Figure 78: Configuration of the clock outputs	108
Figure 79: Closed ripple chain with 2 safety modules start-up behaviour	109
Figure 80: Ripple chain with 3 safety modules	110
Figure 81: Circuit example with emergency stop, door, STO, SS1 and SS2	111
Figure 82: Ripple input configuration for the COMBIVERT FB	111
Figure 83: Ripple output configuration for the COMBIVERT FB	111
Figure 84: Clock signal input configuration for the COMBIVERT FB	112
Figure 85: Ripple input configuration for the COMBIVERT B1X	112
Figure 86: Clock signal input configuration for the COMBIVERT B1X	112
Figure 87: Ripple output configuration for the COMBIVERT B1Z	113
Figure 88: Clock signal input configuration for the COMBIVERT B1Z	113
Figure 89: Clock output configuration for the COMBIVERT B1Z	113
Figure 90: Input1 input configuration for the COMBIVERT B1Z	113
Figure 91: Clock signal input configuration for the COMBIVERT B2X	114
Figure 92: Clock signal input configuration for the COMBIVERT B2Y	114
Figure 93: Clock output configuration for the COMBIVERT B2Y	115
Figure 94: Input1 input configuration for the COMBIVERT B2Y	115
Figure 95: Certificate type examination	118

Tables

Table 1: Overview of the safety functions with possible SIL/PL Level	16
Table 2: Classification according to IEC61508	16
Table 3: Classification according to ISO13849	16
Table 4: Used terms and abbreviations	18
Table 5: Terminal X2B	19
Table 6: User rights to user level	24
Table 7: Parameter List	41
Table 8: Index selection via configurable inputs	51

Table 9: Index selection via configurable inputs53
Table 10: Index selection via configurable inputs56
Table 11: Index selection via configurable inputs58
Table 12: Index selection via configurable inputs60
Table 13: Priority of the safety functions of the safety module71
Table 14: Status of the safety module.....71

2 Basic Safety Instructions

The COMBIVERT is designed and constructed in accordance with state-of-the-art technology and the recognised safety rules and regulations. However, the use of such devices may cause functional hazards for life and limb of the user or third parties, or damages to the system and other material property.

The following safety instructions have been created by the manufacturer for the area of electric drive technology. They can be supplemented by local, country- or application-specific safety instructions. This list is not exhaustive. Non-observance will lead to the loss of any liability claims.

NOTICE

Hazards and risks through ignorance!

- Read all parts of the instructions for use!
- Observe the safety and warning instructions!
- If anything is unclear, please contact KEB!

2.1 Target group

This instruction manual is determined exclusively for electrical personnel. Electrical personnel for the purpose of this instruction manual must have the following qualifications:

- Knowledge and understanding of the safety instructions.
- Skills for installation and assembly.
- Start-up and operation of the product.
- Understanding of the function in the used machine.
- Detection of hazards and risks of the electrical drive technology.
- Knowledge of DIN IEC 60364-5-54.
- Knowledge of national safety regulations (e.g. *DGUV regulation 3*).
- Appropriate knowledge in the field of safety technology.
- Fundamentals in handling the Windows® operating system.

2.2 Validity of this manual

This supplement of the user manual

- complements the manuals of the COMBIVERT by the safety module type 3.
- is only valid in connection with the instructions for use of COMBIVERT.
- contains safety-related supplements and regulations for the operation of devices in safety applications. The basic standards as well as application and country-specific standards must be observed furthermore.
- contains only supplementary safety instructions and standards.

2.3 Electrical connection

⚠ DANGER

Voltage at the terminals and in the device!

Danger to life due to electric shock!

- For any work on the unit switch off the supply voltage and secure it against switching on.
- Wait until the drive has stopped in order that no regenerative energy can be generated.
- Await capacitor discharge time (5 minutes) if necessary, measure DC voltage at the terminals.
- Never bridge upstream protective devices (also not for test purposes).

For a trouble-free and safe operation, please pay attention to the following instructions:

- The electrical installation shall be carried out in accordance with the relevant requirements.
- Cable cross-sections and fuses must be dimensioned according to the design of the machine manufacturer. Specified minimum / maximum values may not be fallen below /exceeded.
- With existing or newly wired circuits the person installing the units or machines must ensure the EN requirements are met.
- For drive converters that are not isolated from the supply circuit (in accordance with [EN 61800-5-1](#)) all control lines must be included in other protective measures (e.g. double insulation or shielded, earthed and insulated).
- When using components without isolated inputs/outputs, it is necessary that equipotential bonding exists between the components to be connected (e.g. by the equipotential line). Disregard can cause destruction of the components by equalizing currents.

NOTICE

SELV/PELV

Selection of suitable voltage sources!

- Use for the connection only suitable voltage sources with protective separation (SELV/PELV) according to VDE 0100 with rated voltage of DC 24V \pm 10%.
- Pay attention on a sufficient overvoltage category of the voltage supply.

2.4 Installation

Additional instructions:

- The unit must be isolated from mains by main switch when working on parts under voltage.
- Mechanical brakes must be installed additionally if external forces have effect to the drive axis, e.g. vertical axes (hanging loads) or rotary axes with asymmetrical weight distribution.
- For the protection against pollution (pollution degree 2) the installation of the units must be provided in environment with increased protection (e. g. control cabinet IP 54).

- Make sure that no small parts fall into the COMBIVERT during assembly and wiring. This also applies to mechanical components, which can lose small parts during operation.
- Check the safety functions and error responses and generate an acceptance report after installation.
- The start-up can be prevented with interruption of the STO signals. STO may not be released in case of danger according to EN 60204-1. Also note the instructions to the external safety switch devices.
- Dimension the safety application by way that the corresponding input current of the safety functions is available for the inputs (see 4.1.4). If several safety modules or safety functions are connected to one safety switchgear unit, this unit must be able to supply all safety modules.

2.5 Start-up and operation

The drive converter must not be started until it is determined that the installation complies with the machine directive; Account is to be taken of [EN 60204-1](#).

DANGER

Improper installation of the safety technology!

Death and serious bodily injuries

- Therefore the safety functions may only be installed and put into operation by qualified personnel which are trained in safety technology.

WARNING

Software protection and programming!

Hazards caused by unintentional behavior of the drive!

- Check especially during initial start-up or replacement of the drive converter if parameterization is compatible to application..
- Securing a unit solely with software-supported functions is not sufficient. It is imperative to install external protective measures (e.g. limit switch) that are independent of the drive converter.
- Secure motors against automatic restart.

2.6 Maintenance

NOTICE

Regular checks!

No guarantee of security!

- In order to ensure permanent security, the functions must be checked in regular intervals according to the results of the risk analysis.

3 Product description

3.1 Validity

This manual describes the safety module type 3

- Material number: 03H6x10-00xx
- Hardware: Safety module type 3
- Firmware version: 3.2.0.1
- used in
 - Servo controller xxS6A3x-xxxx
 - Inverter xxF6A3x-xxxx

FS – Validity of certificates

The certification of controllers with safety technology is only valid if the material number corresponds with the specified numerical code and the FS logo is printed on the type plate.

3.2 Function

With electronic protection devices there are safety functions integrated in the drive control in order to minimize or eliminate danger by malfunctions in machines. The integrated safety functions replace the complex installation of external safety components. The safety functions can be requested or released by an error.

3.3 Safety functions according to IEC 61800-5-2

Function	Description	SIL	PL
STO (Safe Torque Off)	Safe torque off The drive is switched off by the two-channel switching off of commutation of the power semiconductors. After triggering of the function the drive coasts down. The drive reaches the stop position depending on the speed and the active torque.	3	e
SBC (Safe Brake Control)	Safe brake control The function ensures safe brake engage on demand.	3	e
SS1 (Safe Stop 1)	Safe stop 1 The drive is decelerated due to the effect of the drive control, while the brake ramp is monitored. After reaching the idle position or after expiration of a deceleration time, state STO is set.	3	e
SS2 (Safe Stop 2)	Safe Stop 2 The drive is decelerated due to the effect of the drive control, while the brake ramp is monitored. After reaching the idle position, state SOS is set.	3	e
SOS (Safe Operating Stop)	Safe Operating Stop within this safe function the drive has stopped. The motor control remains active and can resist external forces.	3	e
SLS (Safely-Limited Speed)	Safely-Limited Speed Exceeding of a speed limit value is prevented by this function.	3	e
SLP (Safely-Limited Position)	Safely Limited Position This function prevents exceeding of a position limit value.	3	e

Function	Description	SIL	PL
SLI (Safely-Limited Increment)	Safely-Limited Increment A limited increment is monitored with this safety function.	3	e
SDI (Safe Direction)	Safe Direction The safety function monitors the direction of rotation of a drive.	3	e
SSM (Safe Speed Monitor)	Safe Speed Monitor The safety function provides a safe output signal below a specified speed value of a drive.	3	e
SMS (Safe Maximum Speed)	Safe Maximum Speed Exceeding of a speed limit value is prevented by this function.	3	e
SLA (Safe Limited Acceleration)	Safe acceleration The safety function prevents exceeding or falling below the acceleration limit value.	3	e

Table 1: Overview of the safety functions with possible SIL/PL Level



SAR (Safe Acceleration Range) corresponds to SLA with an upper and a lower limit with the same sign.

SSR (Safe Speed Range) corresponds to SLS with an upper and a lower limit with the same sign.

3.4 Classification of the safety functions according to IEC 61508

PFH	$6.6 \cdot 10^{-11} 1/h$
PFD	$5.7 \cdot 10^{-6}$ on demand
Proof-Test-Interval T	20 years

Table 2: Classification according to IEC61508

For SIL classification in connection with the applications consider the failure rates of the external switch devices for final evaluation.

3.5 Classification of the safety functions according to EN ISO 13849

Category	3
MTTF _D	>1500 years
DC	medium

Table 3: Classification according to ISO13849

For the classification within a performance level in connection with the applications consider the failure rates of the external switch devices for final evaluation.

3.6 Safe condition

In case of failure, the module changes into the safe state. The safe state is defined with the following status:

- Modulation off (STO)
- Brake closed (SBC)

All outputs (Clock/Ripple/Out1/Out2) switched off.

3.7 Used terms and abbreviations

Term	Description
0V	earth-potential-free common point
AC	AC current or voltage
ASCL	Asynchronous sensorless closed loop
Auto motor ident.	Automatically motor identification; calibration of resistance and inductance
AWG	American wire gauge
B ₁₀ (B _{10D})	Component characteristic value according to IEC 13849 for stochastic information of the expected lifetime.
COMBIVERT	KEB drive controller
COMBIVIS	KEB start-up and parameterizing software
DC	DC current or voltage
DC brake	Braking of a drive system with a constant DC voltage
DIN	German Institut for standardization
EMC	Electromagnetic compatibility
EN	European standard
EtherCAT®	Real-time Ethernet bus system; EtherCAT® is a registered trademark and patented technology, licensed by Beckhoff Automation GmbH, Germany. It is marked by the following logo: 
Ethernet	Real-time bus system - defines protocols, plugs, types of cables
FE	Function earth
FSoE	Fail Safe over EtherCAT – see Safety over EtherCAT®
FU	Drive converter
GND	Reference potential, ground
IEC	International standard
IP xx	Degree of protection (xx for level)

Logic unit	One of the internal calculation channels of the safety module, typically redundant. Also "logic channel"
Modulation	means in drive technology that the power modules are controlled
MTTF (MTTF _D)	Component characteristic value according to IEC 13849 for stochastic information of the expected lifetime.
NN	above sea level
Emergency switching off	Switching off the voltage supply in emergency case
Emergency stop	Shutdown of a drive in emergency case (not de-energized)
OC	Overcurrent
OH	Overheat
OL	Overload
OSSD	Output switching element; Output Signal Switching Device - an output signal that is checked in regular intervals on its shutdown. (safety technology)
PA	Potential equalization
PDS	Power drive system including motor and sensor
PE	Protective earth
PELV	Protective Extra Low Voltage
PFD	Term used in the safety technology (EN 61508-1...7) for the size of error probability
PFH	Term used in the safety technology (EN 61508-1...7) for the size of error probability per hour
PWM	Pulse-width modulation
Safety over EtherCAT®	<p>Safety over EtherCAT® is a registered trademark and patented technology, licensed by Beckhoff Automation GmbH, Germany. It is marked by the following logo:</p> <p>Safety over  EtherCAT®</p>
SCAMPI	internal communication bus

Table 4: Used terms and abbreviations

4 Description of the I/Os

4.1 Terminal X2B

PIN (x / x bridged)	Name	Function
1 / 2	STO.1	STO inputs
3 / 4	STO.2	
5 / 6	SBC.1	SBC inputs
7 / 8	SBC.2	
9 / 10	FUNC1.1	Function1 inputs
11 / 12	FUNC1.2	
13 / 14	FUNC1.1	Function2 inputs
15 / 16	FUNC2.2	
17 / 18	Ripple.1	Ripple inputs
19 / 20	Ripple.2	
21 / 22	Clock.1	Clock outputs
23 / 24	Clock.2	
25 / 26	Out1	Output1
27 / 28	Out2	Output1
29 / 30	Ripple Out.1	Ripple outputs
31 / 32	Ripple Out.2	

Table 5: Terminal X2B

The voltages of all inputs and outputs refer to the 0V of the COMBIVERT control board and are to be connected there. The pin assignment of the control terminals is described in the respective manual of the COMBIVERT.

4.1.1 Assembly of the wires

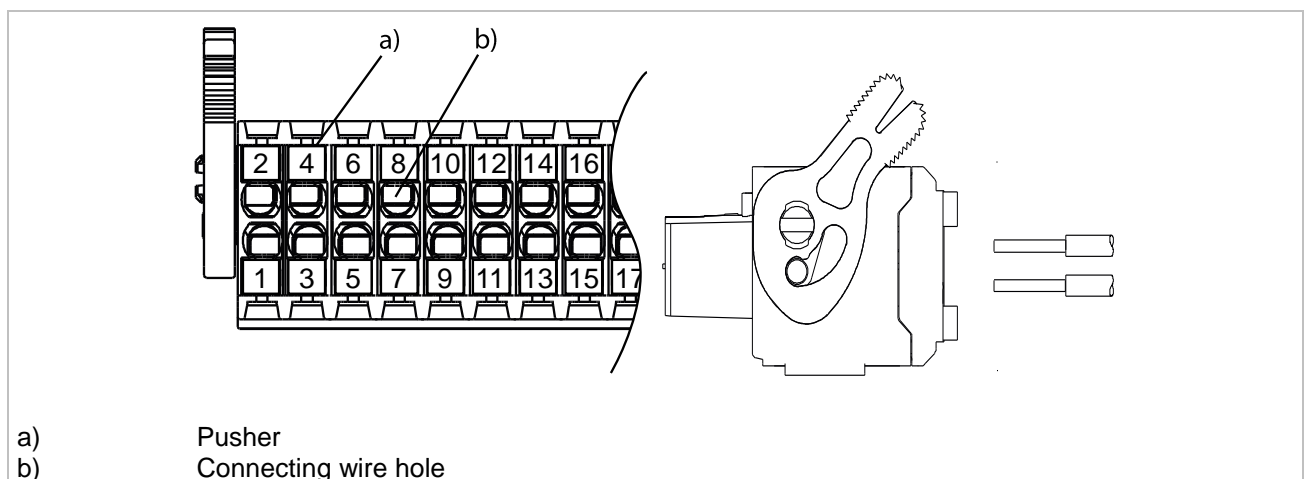

Figure 1: Assembly of the terminal X2B

- Press pusher by hand. Insert connecting wires into the respective hole, that no single wires can be seen from the outside or bend outward. A first resistance must be overcome when inserting. Release the pusher.
- Check that the connecting wire is fixed and can not be pulled-out. It is important to ensure that the connecting wire and not the insulation is clamped. The connecting

wire can also be inserted without pressing the pusher in case of cross-sections upto 1.00 mm².

4.1.2 Assembly of connecting wires with wire-end ferrules according to DIN46228/4

Cross-section / AWG	Metal sleeve length	Stripping length
0.50 mm ² / 21	10 mm	12 mm
0.75 mm ² / 19	12 mm	14 mm
1.00 mm ² / 18	12 mm	15 mm

4.1.3 Assembly of connecting wires without wire-end ferrules

Cross-section / AWG	Stripping length
0.14...1,5 mm ² / 25...16	10 mm
Stranded wire (rigidly and flexibly)	

Note

- KEB generally recommends the use of wire-end ferrules in industrial environments.
- A safe clamping can not be guaranteed when using shorter wire-end ferrules.

4.1.4 Specification of the inputs

The inputs are specified as follows according to IEC61131-2 type 3:

Inputs	Status 0		Status 1	
	UL [V]	IL [mA]	UH [V]	IH [mA]
max.	5	15	30	15
min.	-3	not defined	11	2

The maximum short-term starting current of the input is limited to 30 mA.

4.1.5 Specification of the outputs

The digital outputs are specified according to IEC61131-2. The maximum output current is 100 mA. The outputs are short-circuit proof.

4.2 Terminals brake

The position of the terminals and specification of the brake output is described in the respective manual of the COMBIVERT. The free-wheeling path to control the brake is integrated in the COMBIVERT.

4.3 Terminal encoder interface

The description of the encoder interface is described in the respective manual of the COMBIVERT .

4.4 Status LEDs

Arrangement of the LEDs is defined in the respective manual of the COMBIVERT.

The LED display of the safety mode indicates the following status:

LED	Status
off	No voltage supply of the safety module
green	Safety module in operation
orange	Safety module in reset or new configuration will be saved
red	Safety module in error
Green orange flashing	Flashes for 60 seconds when a new user has logged in.
Green orange double flashing	Flashes orange twice every 1.6 seconds. Signals that the state of the bus communication is not the data state. The safety module is in a safe condition.

5 Parameterization and user management

Parameterization is done with the program KEB COMBIVIS. A KEB safety module can be added to an existing project as follows:

- Right click on the device
- "add object"
- Select entry "KEB safety module" => Figure 2.

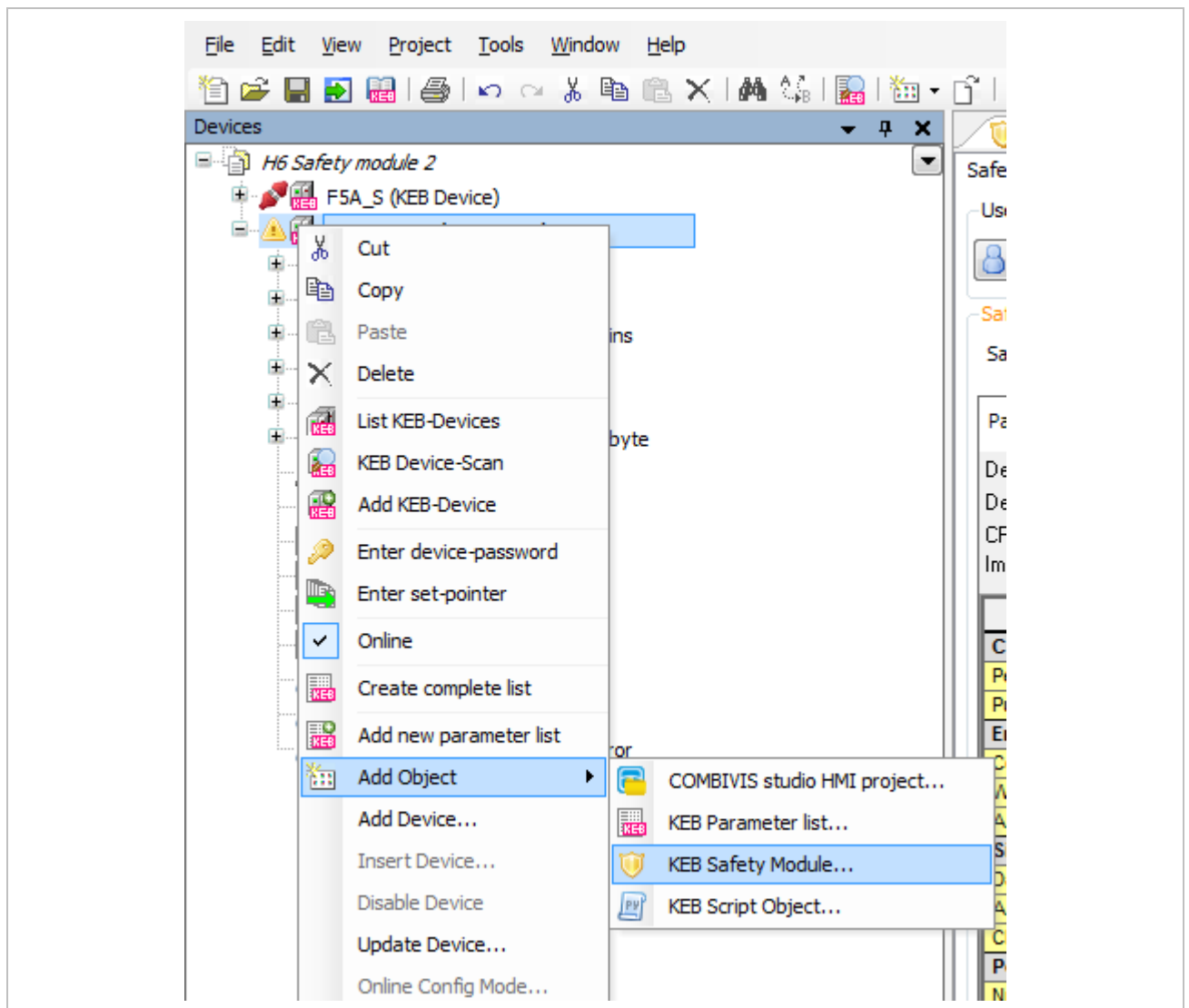

Figure 2: Add KEB safety module

5.1 User management and login

The KEB safety editor contains the user management as first button => Figure 3.

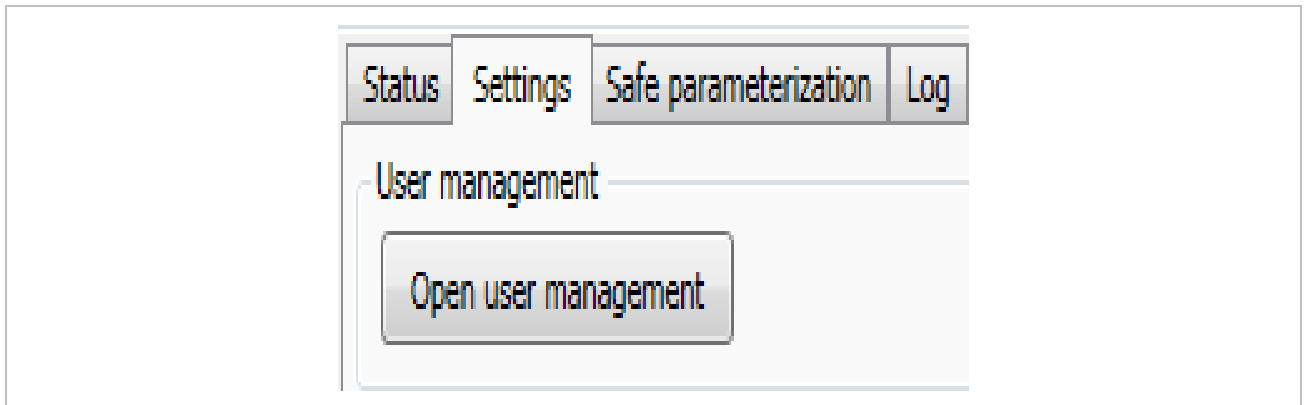

Figure 3: User management in KEB COMBIVIS

Click on "Open user management" to display the window from Figure 4.

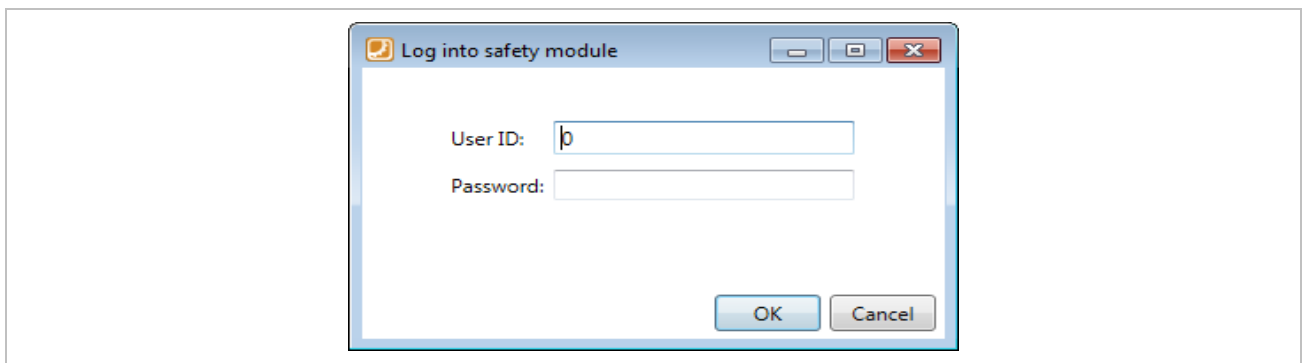

Figure 4: Login window in COMBIVIS

For the first login there is a standard user. The login is done by input of

- User-ID = 1 and password = default
- The safety module flashes for approx. 1 minute after login. With the default user it is only possible to create new users. It is not possible to download safety parameters onto the safety module or to read an existing configuration.
- Users can be created and provided with different rights. The user management is accessible via the button "user settings" => Figure 5. An user-ID and password can be assigned for each user. The user-ID 0 is not possible. Multiple creating of an user with the same user-ID is not possible and an error message is displayed.
- If a new user has been created with the user rights "0 No user rights" and this user is the only registered user in the safety module, then it is still possible to log in with the user ID 1 and password default.

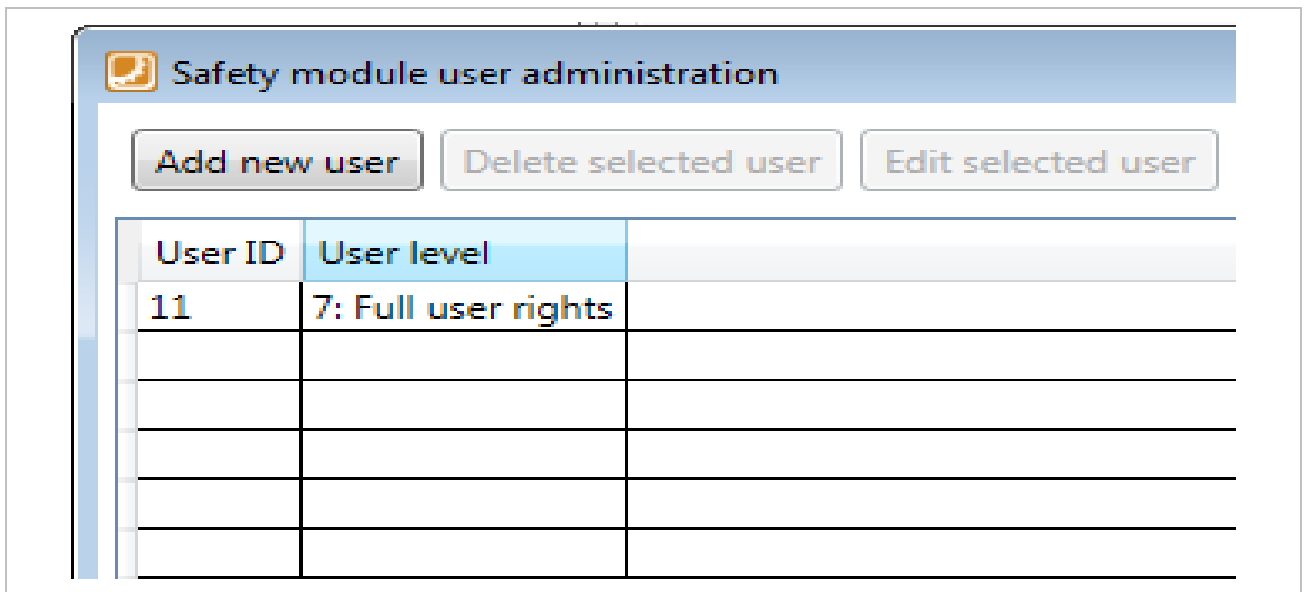

Figure 5: User management for the safety module in COMBIVIS

There are 6 different user rights. When a new user was created the login with the default user is no longer possible.

User level	Login possible	Can change his own password	Can change existing user or add new user	Can download new configuration data	Can read an existing configuration
0: No user rights	x	x			
1: Add and change users	x	x	x		
2: Write new configuration data	x	x		x	
4: Read out configuration information	x	x			x
6: Read out and write configuration information	x	x		x	x
7: Full user rights	x	x	x	x	x

Table 6: User rights to user level

5.2 Safe configuration of parameters of the safety module

The parameters of the safety module can be configured below the user management => Figure 6. The parameters are classified into different groups, which can be filtered by the parameter group selection field. If the mouse pointer remains over a parameter for a longer time, a tool tip appears with further information about the parameter => Figure 7.

The screenshot shows a web interface for 'Safe parameterization'. At the top, there are tabs for 'Status', 'Settings', 'Safe parameterization', and 'Log'. Below the tabs, there is a 'Parameter group:' dropdown menu set to '- Display all groups -', and buttons for 'Download', 'Upload', and 'Im/Export'. The device information is displayed as follows:

- Device Type: **Safety Module Type 3**
- Description: **Parameter version: 3.2.0.1.**
- Device CRC: **0x2CE18DDA**
- Import file: -

The main part of the interface is a table with columns for 'Parameter', 'Value', and 'Unit'. The parameters are grouped into several sections:

Parameter	Value	Unit
Filter time of the safety inputs		
Filter time of the STO-Inputs	0.010000	s
Filter time of the SBC-Inputs	0.010000	s
Filter time of the Function1-Inputs	0.010000	s
Filter time of the Function2-Inputs	0.010000	s
Filter time of the Ripple-Inputs	0.010000	s
Test signal input configuration		
Test signal period	10.000000	s
Test signal pulse length	0.001000	s
Check of the test-signal for the STO-Inputs	off	
Check of the test-signal for the SBC-Inputs	off	
Check of the test-signal for the Function1-Inputs	off	
Check of the test-signal for the Function2-Inputs	off	
STO Hardware input configuration		
Configuration of the STO-Inputs	STO Safe torque off	
Tolerance time of the STO-Inputs	0.010000	s
Status of the STO-Inputs	equivalent	
SBC Hardware input configuration		
Configuration of the SBC-Inputs	SBC Safe brake control	
Tolerance time of the SBC-Inputs	0.010000	s
Status of the SBC-Inputs	equivalent	

Figure 6: Safe configuration of the parameters of the safety module

The tool tip displays detailed configuration options for the ripple input. The parameters and their values are as follows:

Configuration of outputs 1 and 2		
Configuration of Output1		1
Configuration of Output2		32
Switch off delay time	Mapping (bit-wise)	1.000000
Switch on delay time	Value Function	1.000000
Ripple output configu		
Configuration of the Ripp	1: STO	
Ripple Master	2: SBC	2080
Cycle time	4: SS1	off
	8: SS2	5.000000
Clock output configur		
Period of the Clock-Outp	16: SOS	
Pulse length of the Clock	32: SLS	7.000000
	64: SLP (Activation)	0.001000
Encoder configuratio		
Connected encoder	128: SLP Reference position	
Window for maximum dif	256: SLI (Activation)	Resolver
Allowed position differer	512: SLI Next step	50
	1024: SDI	10
	2048: SSM	
Sine Cosine encoder	4096: Fail Safe	
Dash count	Minimum: 0	2048
Allowed position differer	Maximum: 8191	1
Check of zero pulse	Step size: 1	on
Position scale	Default value: 0	

Figure 7: Tool tip for the parameter configuration of the ripple input

5.2.1 Download of new configuration data

The new parameterisation can be transferred to the safety module via the "download" button, if the logged-in user has sufficient rights. With the download the safety module checks again if the parameters are correctly configured. If an error is detected during the transfer of the configuration data, the data are not accepted and the safety module changes into error state. Then the errors can be read out from the range protocol and corrected, see chapter [5.4.1](#).

5.2.2 Read out of existing configuration information from the safety module

If the logged-in user has sufficient rights, then configuration information can be read out from the safety module. It is sufficient to click the button "upload". After the completion of the readout process, the existing configuration is displayed in the configuration editor.

5.2.3 Import and export of configuration data

Configuration data can be imported or exported. Click the button "import/export" and select an option.

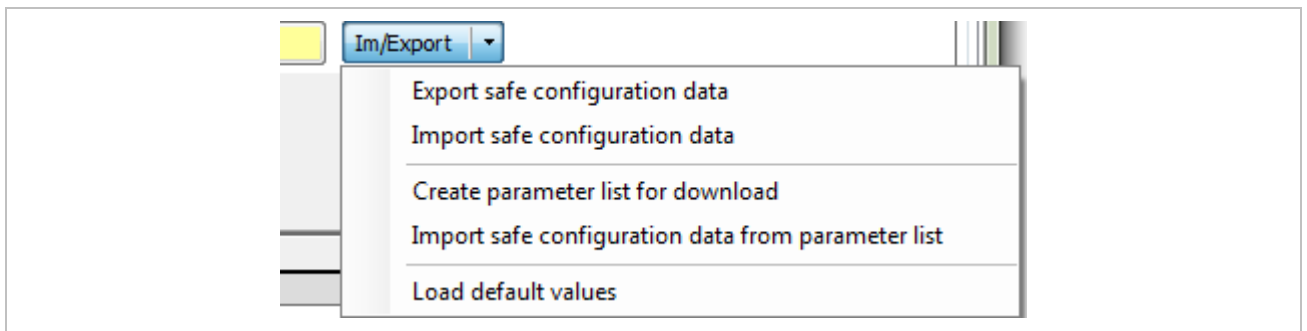

Figure 8: Import and export of configuration data

5.2.4 Export of safe parameter data

The adjusted configuration data can be exported into a file via this menu item. These data can be imported again into another project. A change of the data in the file is not possible, since otherwise the import of data can not be executed.

5.2.5 Import of safe parameter data

Configuration data from a previously exported file can be imported again via this menu item. The data are displayed in the configuration editor after the import. The editor for the configuration data is write protected after the import. The write protection can be removed by a right-click in the editor and the option "unlock".

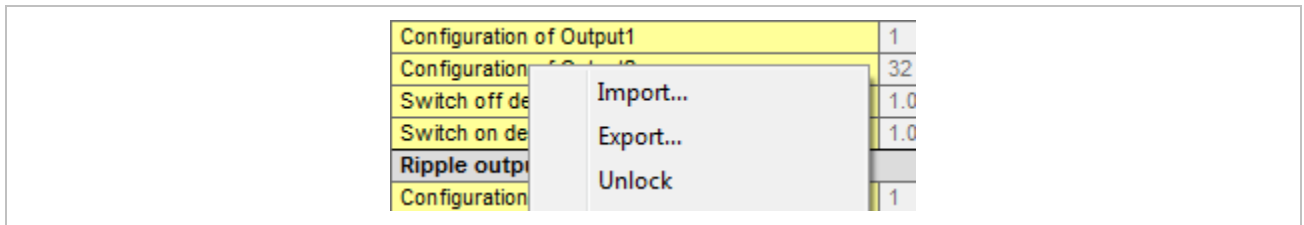

Figure 9: "Unlock" after the import of configuration information



An import is only possible with the same firmware version (e.g. firmware version 3.2.0.1).

5.2.6 Generate parameter list for download

A download list is generated here, which can be transferred without the configuration editor COMBIVIS into the safety module. The download list can not be edited without the configuration editor, otherwise the download of the configuration data is rejected by the safety module.

5.2.7 Import safe parameter data from parameter list

Hereby a previously created download list is imported back into the configuration editor. The data are displayed in the configuration editor after the import.



An import is only possible with the same firmware version (e.g. firmware version 3.2.0.1).

5.3 Status of the safety module

The status of the safety module can be displayed in the "status" tab (=> Figure 10).

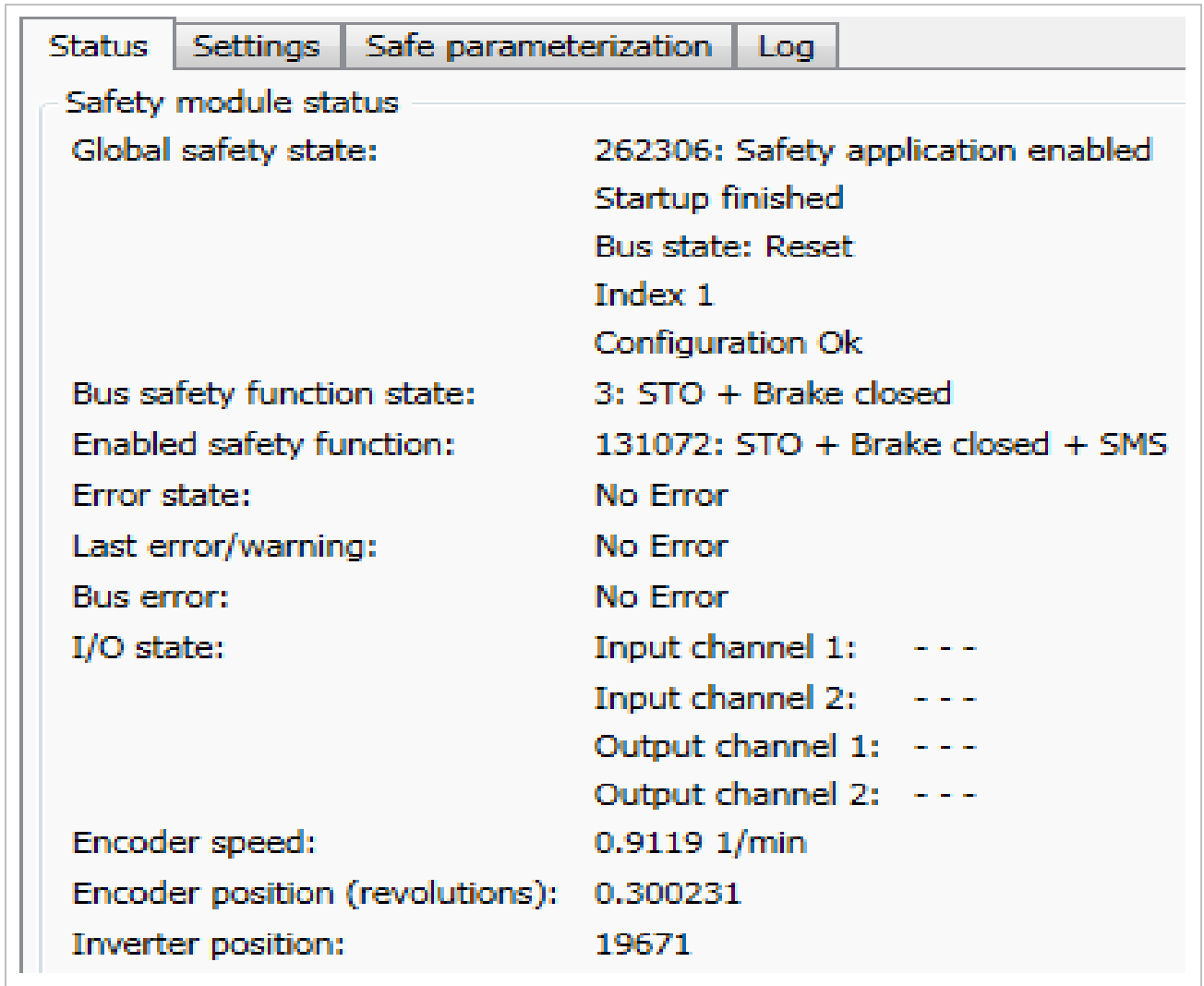

Figure 10: Status tab in the KEB safety editor

- General safety state:**
 Provides information if the safety module works properly and whether the configuration has any faulty entries, for details => chapter [7](#).
- Bus safety function state:**
 Provides information which safety function was requested by the safe bus system.
- Activated safety functions**
 Displays the activated safety functions which have been activated via the inputs and the FSoE data.

- **Error state:**
The error status provides information whether there is an error. The error cause can be detected by the displayed error text (=> Figure 11).

536871649: Error: + Cpu 2 + Error time for SBC input expired.

Figure 11: Error state with error description in COMBIVIS

- **Last error / warning notice:**
The last detected error is displayed here. It may happen that further errors are detected to previously identified errors. These errors are displayed here. Additionally these errors are recorded in the error list.
- **Bus error:**
The last bus error which has been detected during the communication with the safe master is displayed here.
- **I/O state:**
The input and output state is displayed here. The input state is the state of the inputs to the safety module. The outputs on the safety card are designed as two-channel systems. The output state consists of the input state at the terminals of the safety module, the configuration for the outputs and partly from the input state of the control board. In order that the brake can be switched off (switching the brake output), the SBC input of the safety module must be switched on and co00 bit 15 must be set to 1 in the device parameters of the COMBIVERT. Only then the brake output will be switched.
- **Encoder speed:**
The speed of the drive is displayed here. The speed was determined by the safety module.
- **Encoder position (in revolutions):**
The position of the drive is displayed here. If a reference position was already approached and is confirmed with the button, then the position is output depending on the reference position.
- **Inverter position (in bits per revolution):**
The position is indicated here as scaled position value. The position value is displayed with the configured "Position scale". If a reference position was already approached and is confirmed with the button, then the position is output depending on the reference position.

5.4 Read out of the log data

Read out of the log data can be done via the Log tab. There are different types of log data which can be read out. The readout process is started by selecting one or more buttons and then clicking the "Update" button.

The last 20 entries in each category are stored non-volatile.

The log data are based on the clock on the safety module. If this clock is not set correctly, the log data may contain the wrong time and the wrong date. The real-time clock has a power reserve of approx. 2 days.

5.4.1 Read out of errors

The screenshot shows the 'Log' tab interface. At the top, there are tabs for 'Status', 'Settings', 'Safe parameterization', and 'Log'. Below the tabs, there are several categories with checkboxes: '0: Error' (checked), '1: Power on', '2: Power off', '3: Safety function request', '4: New configuration download', '5: Configuration Errors', '6: Bus errors', '7: Bus configuration errors', and '8: Bus safety function request'. A 'Refresh' button is located on the right. Below the categories is a table with the following data:

Index	Type	Date & Time	Position	Speed	Time slots per 62.5 µs	Details
0	0: Error	2017-11-14 3:33:16 PM				805307096: Critical Error: + Cpu 2 + SPI driver TX DMA stream error. The end of the transfer. Please restart the safety module.

Figure 12: Error time, error number and description

Mark the respective category in menu item "protocol" for error read out. Then the error log is read out and displayed by the safety module by clicking on "update".

5.4.2 Read out of switch-on sequences

The screenshot shows the 'Log' tab interface. At the top, there are tabs for 'Status', 'Settings', 'Safe parameterization', and 'Log'. Below the tabs, there are several categories with checkboxes: '0: Error', '1: Power on' (checked), '2: Power off', '3: Safety function request', '4: New configuration download', '5: Configuration Errors', '6: Bus errors', '7: Bus configuration errors', and '8: Bus safety function request'. Below the categories is a table with the following data:

Index	Type	Date & Time	Position	Speed	Time slots per 62.5 µs	Details
0	1: Power on	2017-11-20 7:14:31 AM				---

Figure 13: Switch-on sequences with date and time in log

For read out of the switch-on sequences, set the button "switch-on" in the menu item "protocol" => Figure 13. Then the protocol of the safety module is read out and displayed by click on "update".

5.4.3 Read out of switch-off sequences

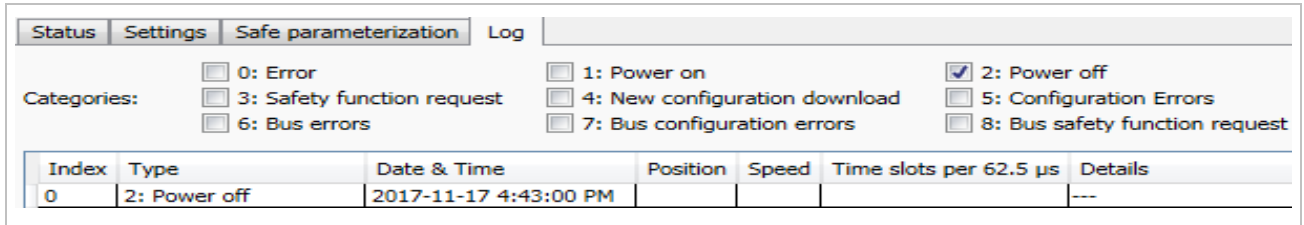

Figure 14: Switch-off sequences with date and time in log

For read out of the switch-off sequences, press the button "switch-off" in the menu item "protocol" => Figure 14. Then the protocol of the safety module is read out and displayed by click on "update". The switch-off time is to 5 minutes precisely.

5.4.4 Read out of requests for safety functions

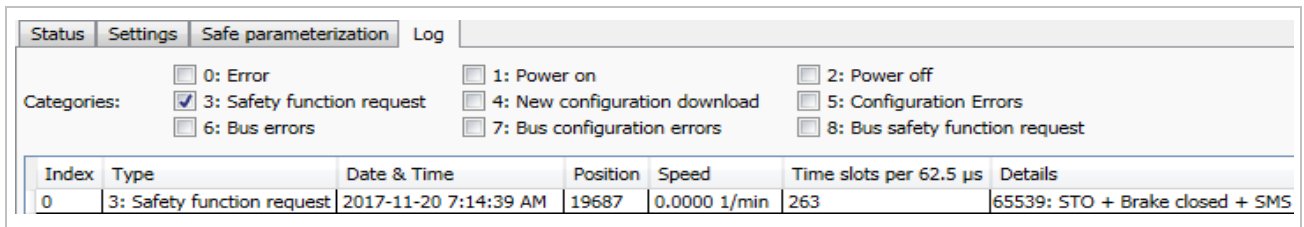

Figure 15: Request times of safety functions

Press the button "safety function execution time" in the menu item "protocol" for read out of the requests of safety functions. Then the log of the safety module is read out and displayed by click on "update".

5.4.5 Read out of the time to assume new configuration data

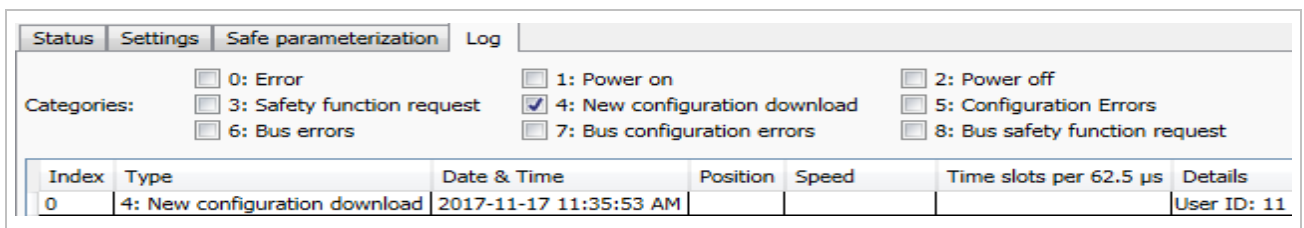

Figure 16: Transfer times of new configuration data

For read out of transfer times of new configuration data, set the button "transfer time of the new configuration" in the menu item "protocol" => Figure 16. Then the log of the safety module is read out and displayed by click on "update". The transfer time and the user-ID is displayed in the protocol.

5.4.6 Read out of configuration errors

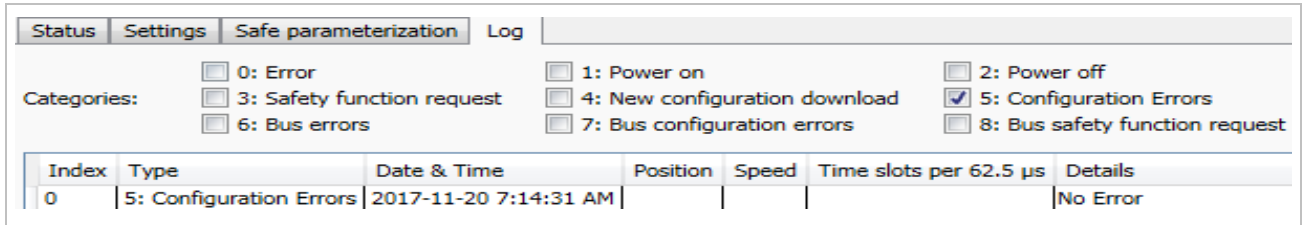

Figure 17: Time, error number and description of configuration errors

For read out of the switch-on sequences, set the button "configuration error" in the menu item "protocol" => Figure 17. Then the protocol of the safety module is read out and displayed by click on "update".

Important:

In case of a configuration error, the faulty configuration is rejected when the safety module is restarted and the last error-free configuration is loaded.

5.4.7 Read out of bus errors

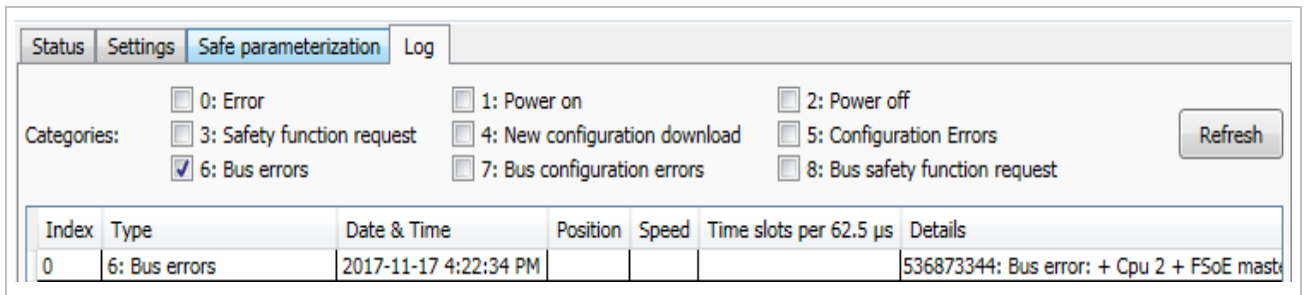

Figure 18: Bus error with date and time in log

For read out of bus errors, set the button "bus error" in the menu item "protocol" => Figure 18. Then the protocol of the safety module is read out and displayed by click on "update".

5.4.8 Read out of bus configuration errors

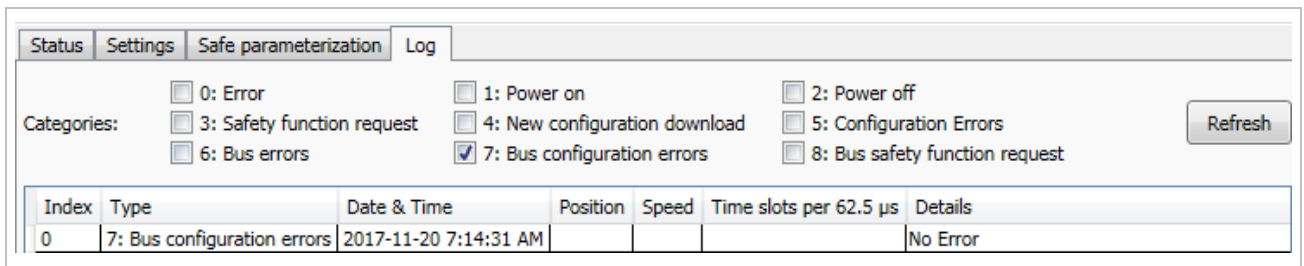

Figure 19: Bus configuration errors with date and time in log

For read out of bus configuration errors, set the button "bus configuration error" in the menu item "protocol" => Figure 19. Then the protocol of the safety module is read out and displayed by click on "update".

5.4.9 Bus request of safety functions

Index	Type	Date & Time	Position	Speed	Time slots per 62.5 μ s	Details
0	8: Bus safety function request	2017-11-20 7:14:31 AM	0	0.0000 1/min	0	3: STO + Brake closed + SMS

Figure 20: Bus request of safety functions in log

For reading out of safety functions, which have been requested by the safe bus system, set the button "bus request of safety functions" in the menu item "protocol" => Figure 20. Then the protocol of the safety module is read out and displayed by click on "update".

5.5 Parameter List

Name	Note	Unit	Minimum	Maximum	Default
Filter times of the safety inputs (=> 8.1)					
Filter time of the STO inputs	Filter time for debouncing of STO safety function input signals	s	0	0.1	0.01
Filter time of the SBC inputs	Filter time for debouncing of SBC safety function input signals	s	0	0.1	0.01
Filter time of the function1 inputs	Filter time for debouncing of safety function2 input signals	s	0	0.1	0.01
Filter time of the function2 inputs	Filter time for debouncing of safety function2 input signals	s	0	0.1	0.01
Filter time of the ripple inputs	Filter time for debouncing of safety function2 input signals	s	0	0.1	0.01
Test signal input configuration (=> 8.2)					
Test signal period	Period of the test signals (clock output) to check the connection. The setting is valid for all inputs	s	0.01	10.0	10.0
Test signal pulse length	Pulse-time of the test signals (clock output) to check the connection. The setting is valid for all inputs	s	0.0005	0.001	0.001
Check of the test signal for the STO inputs	Check of the STO inputs on, if they are connected with a test signal				off
Check of the test signal for the SBC inputs	Check of SBC inputs on, if they are connected with a test signal				off
Check of the test signal for the funktion1 inputs	Check of function1 inputs on, if they are connected with a test signal				off
Check of the test-signal for the function2 inputs	Check of function2 inputs on, if they are connected with a test signal				off
STO hardware input configuration (=> 8.3)					
Assignment of STO inputs	Selection of the safety function which can be activated by the STO inputs		0	18	STO
Tolerance time of the STO inputs	The status between the two STO inputs can be different during the tolerance time	s	0	0.1	0.01

Name	Note	Unit	Minimum	Maximum	Default
Status of the STO inputs	The status of both STO inputs is equivalence or non-equivalence				equivalence
SBC hardware input configuration (=> 8.4)					
Assignment of the SBC inputs	Selection of the safety function which can be activated by the SBC inputs		0	18	SBC
Tolerance time of the SBC inputs	The status between the two STO inputs can be different during the tolerance time	s	0	0.1	0.01
Status of the SBC inputs	The status of both SBC inputs is equivalence or non-equivalence				equivalence
Funktion1 hardware input configuration (=> 8.5)					
Configuration of the funktion1 inputs	Selection of the safety function which can be activated by the funktion1 inputs		0	18	0
Tolerance time of the funktion1 inputs	The status between the two funktion1 inputs can be different during the tolerance time.	s	0	0.1	0.01
Status of the funktion1 inputs	The status of both funktion1 inputs is equivalence or non-equivalence				equivalence
Function2 hardware input configuration (=> 8.6)					
Configuration of the funktion2 inputs	Selection of the safety function which can be activated by the funktion2 inputs		0	18	0
Tolerance time of the funktion2 inputs	The status between the two STO inputs can be different during the tolerance time	s	0	0.1	0.01
Status of the funktion2 inputs	The status of both funktion2 inputs is equivalence or non-equivalence				equivalence
Ripple hardware input configuration (=> 8.7)					
Configuration of the ripple inputs	Selection of the safety function which can be activated by the ripple inputs		0	18	0
Tolerance time of the ripple inputs	The status between the two ripple inputs can be different during the tolerance time	s	0	0.1	0.01
Configuration of the outputs 1 and 2 (=> 9.1)					
Output 1 configuration	Assignment (bitwise)		0	131071	0

Parameter List

Name	Note	Unit	Minimum	Maximum	Default
Output2 configuration	Assignment (bitwise)		0	131071	0
Switch on delay time	Outputs 1 and 2 are switched on with a delay to the switching condition	s	0	1	0.0
Ripple output configuration (=> 9.2)					
Ripple output configuration	Assignment (bitwise)		0	8191	0
Ripple master	When set to "on", this safety module is the master of the ripple chain				off
Cycle time	Required time to send the ripple signal through a closed chain	s	0	60	0.0
Clock output configuration (=> 9.3)					
Period of the clock outputs	Period of the test signals to check the connection	s	0.01	10	10.0
Pulse length of the clock outputs	Pulse-time of the test-signals (clock-output) to check the connection.	s	0,000 5	0,001	0,001
Encoder configuration (=> 10.1)					
Connected encoder	Selection of encoder type <ul style="list-style-type: none"> ▪ no encoder ▪ SIN/COS-encoder ▪ Resolver 				no encoder
Window for maximum difference	The deviation of the sine and cosine signals is monitored by $\sin^2 x + \cos^2 x = 1 \pm$ window	%	0	95	50
Allowed position difference between the input channels	If the difference of the position determination of the two CPUs is higher than the adjusted value, the module changes into the safe state	°	1	90	10
Sine cosine encoder configuration (=> 10.2)					
Increments per revolution	Number of sine/ cosine periods per revolution		128	16000	2048
Allowed position difference	If the difference between the position in increments and the number of sine or cosine channel pulses is bigger as this parameter, than the safety module is		1	Increments per revolution / 2 - 1	1

Name	Note	Unit	Minimum	Maximum	Default
	going to the safety state. The maximum value is $(\text{dash count} * 4) / 2 - 1$.				
Check of zero pulse	The check of the zero pulse can be switched off				on
Scaling settings of the position (=> 10.4)					
Number of bits per revolution (Ps)	The resolution of the position is configured by this parameter (Unit Ps). The 32 bit position values are divided into the parameter value for the bit per revolution and the remaining bits are used for the full turns	Bit	2	30	16
Settings for speed measurement (=> 10.5)					
Speed scan time	Parameter specifies the time over which the engine speed average is calculated		2	7	4
Speed PT1 time	Parameter specifies the time of the PT1 filter for the speed calculation	ms	0	256	2,0
SBC: Safe Brake Control (=> 11.4)					
Coupling of SBC with STO	When on, the SBC function is activated when the STO function is executed				off
Measurement of the brake current	The measurement of the brake current can be enabled (on). If the current is bigger than 3.3 A, the module is transferred to a safe state				on
SDI: Safe Direction (=> 11.12)					
Error function	Selection of the function that is executed at wrong direction. (STO or SS1)		STO	SS1	STO
Position window at standstill	When speed = 0 and position changes, which are smaller than the position window, no direction of rotation is determined	PS	0	$2.147 \cdot 10^9$	0

Parameter List

Name	Note	Unit	Minimum	Maximum	Default
Time window of the direction of rotation	If a wrong direction of rotation is detected, and it is existed for longer than the specified time window, the selected error function is executed	s	0	1	0
SS1: Safe Stop 1 (=> 11.5)					
Selection of the type of the function	Possible types of functions: <ul style="list-style-type: none"> • SS1-r and SS1-t • SS1-r (former type B) • SS1-t (former type C) 				SS1-r and SS1-t
Deceleration	Specification of the monitoring ramp. Speed change in the time period of delta t.	1/s ²	0	60000	0.0
Negative tolerance	The allowed negative tolerance to the ramp	rpm	0	60000	0.0
Positive tolerance	The allowed positive tolerance to the ramp	rpm	0	60000	0.0
Time window of speed deviation	If the deviation of the velocity is greater than the tolerance and longer than the specified time window existed, the STO function is executed	s	0	600	0.0
Type C time	Time period till the STO function is activated	s	0	600	0.0
Higher deceleration allowed	The speed must not be higher than the deceleration + positive tolerance. However, the lower speed limit is 0 - negative tolerance. Thus the drive can also decelerate faster.		0	1	off
SS2: Safe Stop 2 (=> 11.6)					
Selection of the type of the function	Possible types of functions: <ul style="list-style-type: none"> • SS1-r and SS1-t • SS1-r (former type B) • SS1-t (former type C) 				SS1-r and SS1-t
Deceleration	Specification of the monitoring ramp. Speed change in the time period of delta t.	1/s ²	0	60000	0.0
Negative tolerance	The allowed negative tolerance to the ramp	rpm	0	60000	0.0
Positive tolerance	The allowed positive tolerance to the ramp	rpm	0	60000	0.0

Name	Note	Unit	Minimum	Maximum	Default
Time window of speed deviation	If the deviation of the velocity is greater than the tolerance and longer than the specified time window existed, the STO function is executed	s	0	600	0.0
Type C time	Time period till the SOS function is activated	s	0	600	0.0
Higher deceleration allowed	The speed must not be higher than the deceleration + positive tolerance. However, the lower speed limit is 0 - negative tolerance. Thus the drive can also decelerate faster.		0	1	off
SLS: Safely-Limited Speed (=> 11.8)					
Upper speed limit	If the speed exceeds the upper speed limit, then the error function will be activated.	rpm	- 60000	60000	6000 0
Lower speed limit	If the speed falls below the lower speed limit, then the error function will be activated.	rpm	- 60000	60000	- 6000 0
Tolerance time	Time from which the overrun of the speed limit is detected	s	0	60	0.0
Error function	Selection of the function that is executed when the limit is passed. (STO or SS1)		STO	SS1	STO
SSM: Safe Speed Monitor (=> 11.13)					
Upper speed limit	The maximum permitted speed.	rpm	- 60000	60000	0.0
Lower speed limit	The minimum permitted speed.	rpm	- 60000	60000	0.0
Hysterese	If the speed exceeds the speed level + hysteresis, then the configured output is activated. At underrun of speed level - hysteresis, the output is disabled.	rpm	0	60000	0.0
Monitoring always active	At "off" the speed monitoring has to be activated via an input. At "on" it is always activated.				off
SMS: Safe Maximum Speed (=> 11.14)					

Parameter List

Name	Note	Unit	Minimum	Maximum	Default
Upper speed limit	The maximum permitted speed.	rpm	- 60000	60000	0.0
Lower speed limit	The minimum permitted speed.	rpm	- 60000	60000	0.0
Tolerance time	This is the time within the maximum or minimum speed shall be exceeded.	s	0	60	0
Error function	When exceeding the adjusted maximum speed by the tolerance time, this error function is executed. STO or SS1.		STO	SS1	STO
SLA: Safe Limited Acceleration (=> 11.15)					
Upper acceleration limit	The maximum permitted acceleration.	1/s ²	-1 · 10 ⁶	1 · 10 ⁶	0
Lower acceleration limit	The minimum permitted acceleration.	1/s ²	-1 · 10 ⁶	1 · 10 ⁶	0
Error function	This error function is carried out if the upper acceleration limit is exceeded, or if the lower acceleration limit is fallen below. STO or SS1.		STO	SS1	STO
SOS: Safe Operating Stop (=> 11.7)					
Position window	Tolerance window of the standstill position	Ps	-2.147 · 10 ⁹	2.147 · 10 ⁹	0
Time window for position deviations	If the position difference to the standstill position is greater than the position window and this existed longer than the set time window, the STO function is activated	s	0	60	0.0
SLI: Safely-Limited Increment (=> 11.11)					
Limited increment	Configuration of the position difference, that the drive can be executed, if an increment via the input was triggered	Ps	0	4.295 · 10 ⁹	0
Minimum stay in the position window	Configuration of the time, that the drive must stay in the SOS function with the position window, before a new increment is taken	s	0	1	0.0

Name	Note	Unit	Minimum	Maximum	Default
Error function	Selection of the function that is executed out at a breach of the limited increment (STO or SS1)		STO	SS1	STO
Position window	Tolerance window of the position	Ps	0	$4.295 \cdot 10^9$	0
Time window for position deviations	If the position difference is greater than the position window and this is existed longer than the time window, the selected error function is activated	s	0	1	0.0
SLP: Reference position (=> 11.9)					
Absolute reference position	Configuration of the position at the reference point	Ps	$-2.147 \cdot 10^9$	$2.147 \cdot 10^9$	0
SLP: Safely-Limited Position (=> 11.10)					
Maximum drive position	If the position is greater than the configured value, the drive executes the selected error function	Ps	$-2.147 \cdot 10^9$	$2.147 \cdot 10^9$	0
Minimum drive position	If the position is lower than the configured value, the drive executes the selected error function	Ps	$-2.147 \cdot 10^9$	$2.147 \cdot 10^9$	0
Error function	Selection of the function that is executed when leaving the position range (STO or SS1)		STO	SS1	STO
SEL: Difference position	As soon as the difference position to the max. or min. position has been reached, the safety function SEL is activated	PS	0	$2.147 \cdot 10^9$	0
SEL: Limit for the speed:	If the safety function SEL is activated, the speed of the drive must not be increased beyond the limit. This is a ramp up to SLP maximum drive position.	rpm	0	60000	0
Bus settings (=> 12)					
Bus type	This is the selection of the safe bus type. The selection parameters are „No bus“ or „FSoE“.		0	1	No bus
Safety module address	Safety module address in the safety fieldbus		0	65534	0
Safe bus data length	If a safe bus system has been selected, the length of the safe data can be adjusted here		0	19	11

Table 7: Parameter List

6 Operating condition of the safety module

The operating and error state can be checked in COMBIVIS via the KEB safety editor. For this see Status des Sicherheitsmoduls in chapter 5.3.

6.1 Global operating condition

The operating condition of the safety module is divided into different states. Figure 21 displays the different states for the safety module.

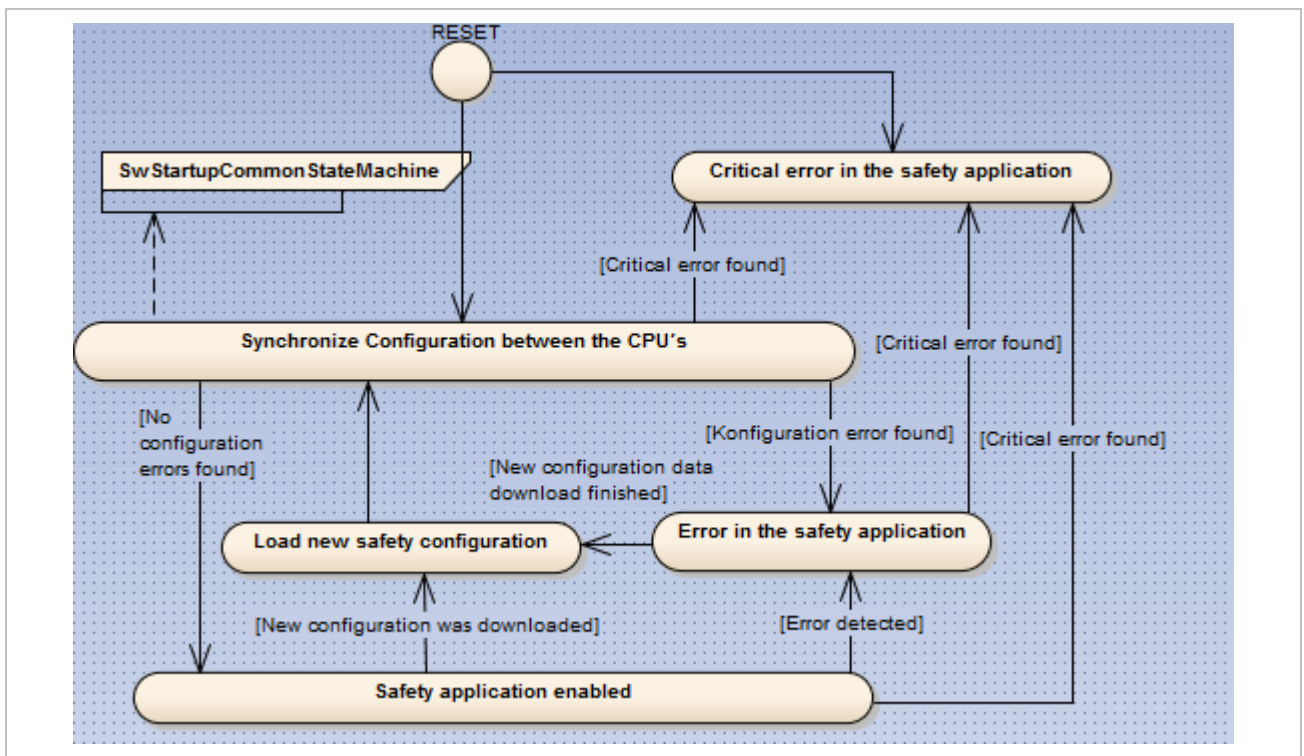

Figure 21: The global status of the safety module

0. **Reset:**
This is the status when the safety module is switched on. The safety module performs the safety function STO.
1. **Synchronize configuration between the CPUs:**
The safety module has 2 independent CPUs. After the configuration has been loaded, it must be transferred to the 2 CPUs and checked. The safety module performs the safety function STO.
2. **Safety operation released:**
The safety module is ready to carry out safety operations.
3. **Critical error in the safety module:**
A critical error has been detected in the safety module. The detected error can be checked in status safety module. The safety module performs the safety function STO. This status is permanent and can be left only by a power on reset.
4. **Error in the safety module:**

A non-critical error has been detected in the safety module, e.g. a configuration error. The state can be left by downloading a new configuration or by power on reset.

5. Loading of new safety configuration:

New configuration data were transferred to the safety module. Now the new configuration data are complete and in the next step the safety module tries to validate the configuration data.

6.2 Start of the safety module and transfer of new configuration data

Starting the safety module and the appropriate software is divided into different states. Figure 22 displays the different states of the safety module when starting.

0. Software is initialised:

This status indicates that the software has been initialised. The configuration data is read from the memory.

1. CPU communication is started:

The safety module has 2 CPUs. In order that configuration data can be exchanged, the data communication between the two CPUs must be functional.

2. Synchronize time slot:

The two CPUs of the safety module must run synchronously. Therefore the time slot must be synchronised.

3. Start the synchronisation of the configuration:

Now the configuration is provided for the synchronisation from one to the other CPU of the safety module.

4. Complete the synchronisation of the configuration:

Now the configuration is transferred to the other CPU.

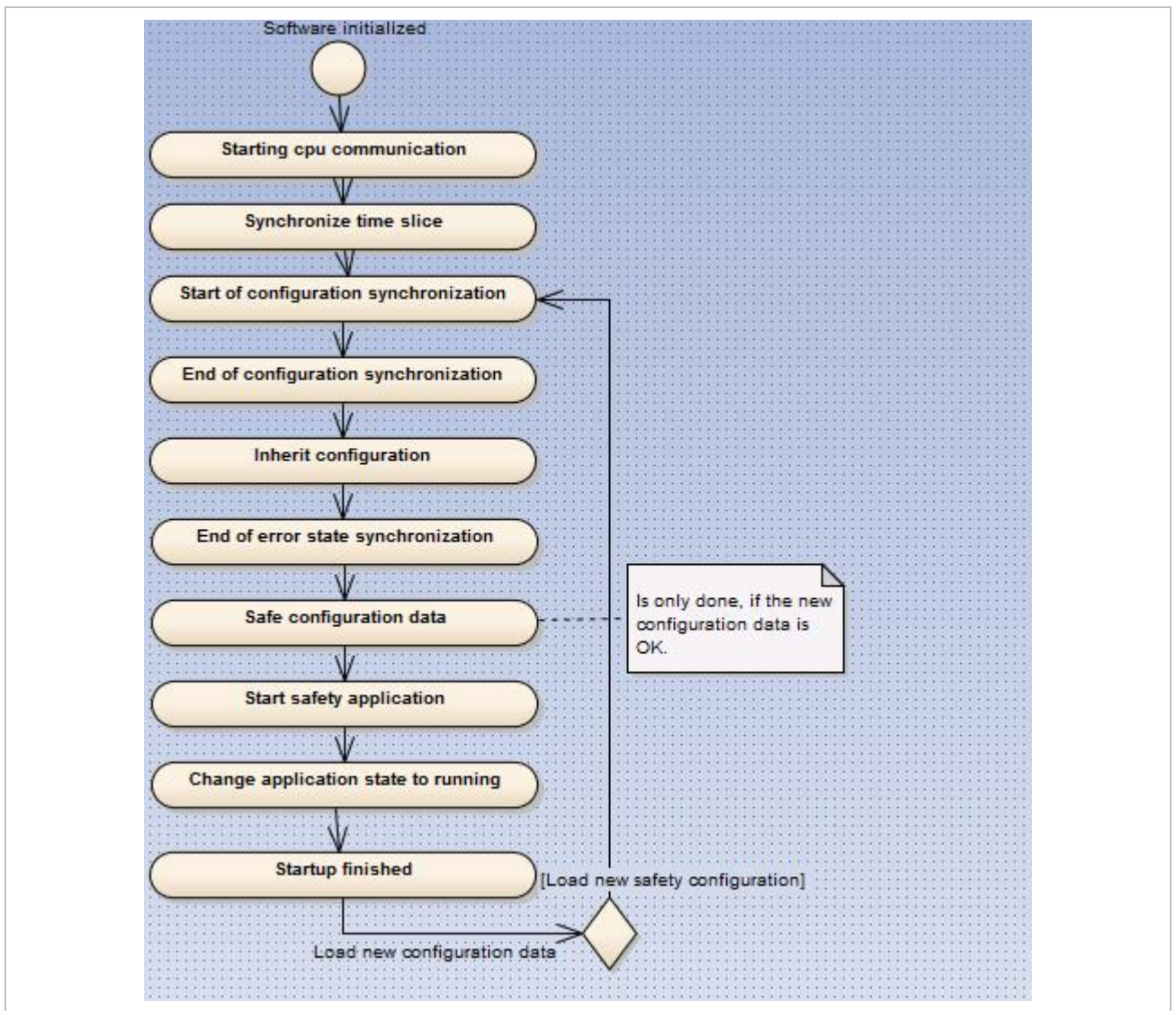

Figure 22: Booting the safety module

5. **Configuration data transfer:**
The configuration transfer is complete. The configuration data are now checked for plausibility.
6. **Complete the synchronisation of the error status:**
Configuration errors have been provided after configuration data transfer and are now exchanged between the two CPUs.
7. **Safe the configuration data:**
These data are now saved if the configuration data have no error.
8. **Start the safety software:**
The safety software can be started now, the configuration data are available.
9. **Change the application status to safety operation released:**

The general operating mode is changed now to safety operation released. The general operating mode is changed to error in the safety module if an error was detected in the configuration.

10. Booting the safety module completed:

The safety module is now able to carry out safety operations.

6.3 Error reset

Errors can be reset as follows

- Restart (Power-On-Reset)
- Loading a configuration
- Digital input (fail safe bit); Reset by switching off the voltage
- Resetting the fail safe reset bit

7 Configuration state and configuration transfer

7.1 Configuration state

The configuration status displays whether new configuration data are error-free. Figure 23 displays the different states of the safety module.

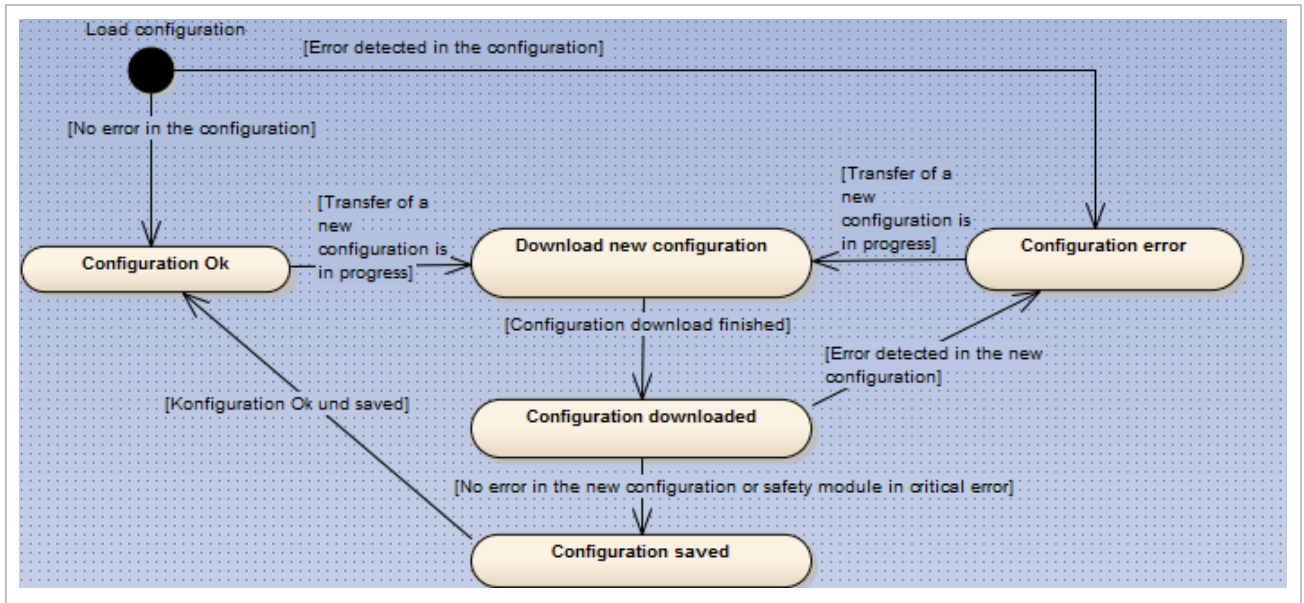

Figure 23: Configuration state of the safety module

0. **Load configuration:**
The configuration data are loaded from the non-volatile memory.
1. **Download of the new configuration:**
Just download new configuration data.
2. **Configuration stored:**
Configuration data were downloaded, are error-free and were stored in non-volatile memory. Or the safety module is in state "Critical error in the safety module". Then, the new configuration is stored without checking the correctness. This is done with the next start of the safety module.
3. **Configuration is incorrect:**
The configuration is incorrect and is not stored. The configuration error can be read in the configuration log.
4. **Configuration OK:**
The configuration has been downloaded, checked and is error-free. The configuration has been stored.

7.2 Create configuration data for different machines

Configuration data for different machines can be equipped with a "safety module address". An address between 0 and 65535 can be configured individually for each safety module. If a configuration is downloaded to the safety module, the new configuration is accepted only if the addresses are conform.

The safety module address in the configuration data is displayed in Figure 24.

Fieldbus parameter	
Safety address	0

Figure 24: Safety module address in the configuration data

8 Input configuration and input parameter

The safety module has 2 configurable inputs, 2 fixed assigned inputs and a ripple input.

- The fixed assigned inputs can be used for safety function STO and SBC.
- Configurable inputs can be used for triggering of safety functions.
- The ripple input is used to network the safety module with other safety modules.

8.1 Filter time for the safety inputs

A filter time can be configured for each safety input. Figure 25 displays the configuration options.

Parameter	Value	Unit
Filter time of the safety inputs		
Filter time of the STO-Inputs	0.100000	s
Filter time of the SBC-Inputs	0.100000	s
Filter time of the Function1-Inputs	0.100000	s
Filter time of the Function2-Inputs	0.100000	s
Filter time of the Ripple-Inputs	0.100000	s

Figure 25: Filter time for the safety inputs (input configuration)

Parameterization

- **Filter time of the STO inputs:**
- **Filter time of the SBC inputs:**
- **Filter time of function1 inputs:**
- **Filter time of function2 inputs:**
- **Filter time of the ripple inputs:**

A change of the input status is conditional delayed by the filter time. The filter time is used to suppress interferences at the input.

8.2 Clock signal input configuration for all inputs

Each input of the safety module, except the ripple input, can be connected to a signal on which test signals are performed. The logic of the signal is cyclically inverted for one clock signal. The clock input analysis detects cross-faults between the input channels. To detect dangerous line short circuits between two related inputs, contact pairs are supplied via phase-shifted clock outputs. Here, e.g., the clock outputs of the safety module are connected to the clock inputs via switch. Figure 26 displays the configuration parameter.

Parameter	Value	Unit
Test signal input configuration		
Test signal period	10.000000	s
Test signal pulse length	0.001000	s
Check of the test-signal for the STO-Inputs	off	
Check of the test-signal for the SBC-Inputs	off	
Check of the test-signal for the Function1-Inputs	off	
Check of the test-signal for the Function2-Inputs	off	

Figure 26: Clock signal input configuration for the safety inputs

Parameterization

- **Test signal cycle duration:**
This parameter affects the evaluation of the test signal of all safety inputs. The period is the time from a test signal to the next. The period must agree with the adjustment of the period for the clock outputs, which are connected to the respective inputs.
- **Test pulse length:**
This parameter affects the evaluation of the clock signal of all safety inputs. The pulse length must agree with the adjustment of the pulse length for the clock outputs, which are connected to the respective inputs.
- **Evaluation of the test signal for the STO inputs:**
- **Evaluation of the test signal for the SBC inputs:**
- **Evaluation of the test signal for the function1 inputs:**
- **Evaluation of the test signal for the function2 inputs:**
If "on" is selected here, then it is continuously checked, whether a clock signal with the configured period and pulse length is detected at the input. Furthermore, it is checked that the clock signal is not available simultaneously at channel 1 and channel 2. If no clock signal has been detected 5 times successively, the safety module changes into the safe state.
This check is not performed with the selection "off".

Important:

- The clock input configuration must agree with the clock output configuration of the connected outputs.
-

8.3 STO hardware input configuration

The STO input normally is used to trigger the safety function STO => chapter 11.3. However, the input can also be configured differently. Figure 27 displays the parameters for the STO hardware safety input.

Parameter	Value	Unit
STO Hardware input configuration		
Configuration of the STO-Inputs	STO Safe torque off	
Tolerance time of the STO-Inputs	0.010000	s
Status of the STO-Inputs	equivalent	

Figure 27: Parameters for the STO safety input

Parameterization

- **Assignment of the STO input:**
The safety function which is triggered by the STO input can be selected here. The following safety functions are available:
 - **no function:**
The safety input is not assigned with a safety function.
 - **STO:**
The safety function „Safe Torque Off“ is carried out => [11.3](#).
 - **SBC:**
The safety function "Safe Brake Control" is carried out => [11.4](#).
 - **SS1:**
The safety function "Safe Stop 1" is carried out => [11.5](#).
 - **SS2:**
The safety function "Safe Stop 2" is carried out => [11.6](#).
 - **SOS:**
The safety function "Safe Brake Control" is carried out => [11.7](#).
 - **SLS:** The safety function "Safely-Limited Speed" is carried out => [11.8](#).
 - **SLP:** The safety function "Safely-Limited Speed" is carried out => [11.9](#).
 - **Set SLP reference point:**
The safety function "Set Safely-Limited Position of reference position" is carried out => [11.9](#).
 - **SLI activation:**
When the input is active, the SLI function is **not** active. If the function is not selected or the input is not active, the safety function "Safely-Limited Increment" is carried out in addition to other selected safety functions => [11.11](#).

- **SLI Next Step:**
Sets the input "SLI Next Step" for the safety function "Safely-Limited Increment" => [11.11](#).
- **SDI forward:**
The safety function "Safe Direction" is carried out=> [11.12](#).
- **SDI reverse:**
The safety function "Safe Direction" is carried out=> [11.12](#).
- **SSM:**
The safety function "Safe Speed Monitor" is carried out => [11.13](#).
- **SLA:**
The safety function "Safe Limited Acceleration" is executed => [11.15](#).
- **Reset Fail safe:**
If a safety function detects an error, e.g. because limits have been exceeded, then the fail safe bit is set in the status. The reset is carried out when the voltage at the input is switched off.
- **Subindex Bit 0, 1, 2:**
Many safety functions have indices. This allows up to 8 possible configurations to be stored, depending on the operating mode. With the correspondingly configured inputs (subindex bit 0, 1, 2), these configurations can be activated in accordance with Index selection via configurable inputs (Table 8). Alternatively, change-over is also possible via FSoE.

Index	Value	Input 3 (Bit 2)	Input 2 (Bit 1)	Input 1 (Bit 0)
Index 1	0	0	0	0
Index 2	1	0	0	1
Index 3	2	0	1	0
Index 4	3	0	1	1
Index 5	4	1	0	0
Index 6	5	1	0	1
Index 7	6	1	1	0
Index 8	7	1	1	1

Table 8: Index selection via configurable inputs

- **Tolerance time of the STO inputs:**
The STO input is designed as two-channel system. This can cause that a channel is switched earlier or later than the second channel. Enter a tolerance time here to ensure that this does not immediately result in an error.
- **State of the STO inputs:**
The input state between the two channels is antivalent or equivalent:
 - At equivalent the two safety inputs must always be switched the same. It is not allowed to supply a channel with 24V input voltage and the other channel with 0V. The safety function is carried out if the input voltage is 0V.
 - At antivalent one channel must be supplied always with 24V and the other channel with 0V.
The following applies:

- The safety function is not carried out if STO.1 is supplied with an input voltage of 24V.
- The safety function is carried out if STO.1 is supplied with an input voltage of 0V.

8.4 SBC hardware input configuration

The SBC input normally is used to trigger the safety function SBC => [11.4](#). However, the input can also be configured differently. Figure 28 displays the parameters for the SBC safety input.

Parameter	Value	Unit
SBC: Safe brake control		
Coupling of SBC with STO	off	
Measurement of the brake current	on	

Figure 28: Parameters for the SBC safety input

Parameterization

- **Assignment of the SBC inputs:**
The safety function which is triggered by the SBC input can be selected here. The following safety functions are available:
 - **no function:**
The safety input is not assigned with a safety function.
 - **STO:**
The safety function „Safe Torque Off“ is carried out => [11.3](#).
 - **SBC:**
The safety function "Safe Brake Control" is carried out => [11.4](#).
 - **SS1:**
The safety function "Safe Stop 1" is carried out => [11.5](#).
 - **SS2:**
The safety function "Safe Stop 2" is carried out => [11.6](#).
 - **SOS:**
The safety function "Safe Operating Stop" is carried out => [11.7](#).
 - **SLS:** The safety function "Safely-Limited Speed" is carried out => [11.8](#).
 - **SLP:** The safety function "Safely-Limited Speed" is carried out => [11.9](#).
 - **Set SLP reference point:**
The safety function "Set Safely Limited Position of reference position" is carried out => [11.9](#).
 - **SLI activation:**
When the input is active, the SLI function is **not** active. If the function is not selected or the input is not active, the safety function "Safely-Limited Increment" is carried out in addition to other selected safety functions => [11.11](#).

- **SLI Next Step:**
Sets the input "SLI Next Step" for the safety function "Safely-Limited Increment" => [11.11](#).
- **SDI forward:**
The safety function "Safe Direction" is carried out => [11.12](#).
- **SDI reverse:**
The safety function "Safe Direction" is carried out => [11.12](#).
- **SSM:**
The safety function "Safe Speed Monitor" is carried out => [11.13](#).
- **SLA:**
The safety function "Safe Limited Acceleration" is executed => [11.15](#).
- **Reset Fail safe:**
If a safety function detects an error, e.g. because limits have been exceeded, then the fail safe bit is set in the status. The reset is carried out when the voltage at the input is switched off.
- **Subindex Bit 0, 1, 2:**
Many safety functions have indices. This allows up to 8 possible configurations to be stored, depending on the operating mode. With the correspondingly configured inputs (subindex bit 0, 1, 2), these configurations can be activated in accordance with Index selection via configurable inputs (Table 8). Alternatively, change-over is also possible via FSoE.

Index	Value	Input 3 (Bit 2)	Input 2 (Bit 1)	Input 1 (Bit 0)
Index 1	0	0	0	0
Index 2	1	0	0	1
Index 3	2	0	1	0
Index 4	3	0	1	1
Index 5	4	1	0	0
Index 6	5	1	0	1
Index 7	6	1	1	0
Index 8	7	1	1	1

Table 9: Index selection via configurable inputs

- **Tolerance time of the SBC inputs:**
The SBC input is designed as two-channel system. This can cause that a channel is switched earlier or later than the second channel. Enter a tolerance time here to ensure that this does not immediately result in an error.
- **State of the SBC inputs:**
The input state between the two channels is antivalent or equivalent:
 - At equivalent the two safety inputs must always be switched the same. It is not allowed to supply a channel with 24V input voltage and the other channel with 0V. The safety function is carried out if the input voltage is 0V.
 - At antivalent one channel must be supplied always with 24V and the other channel with 0V.
The following applies:
 - The safety function is not carried out if SBC.1 is supplied with an input voltage of 24V.
 - The safety function is carried out if SBC.1 is supplied with an input voltage of 0V.

8.5 Function1 hardware input configuration

The function1 input of the safety module can be used for different safety functions. The safety function to be performed can be parameterized. Figure 29 displays the parameters for input 1.

Parameter	Value	Unit
Function 1 Hardware input configuration		
Configuration of the Function1-Inputs	Hardware input disabled	
Tolerance time of the Function1-Inputs	0.010000	s
Status of the Function1-Inputs	equivalent	

Figure 29: Parameters for the function 1 input

Parameterization

- **Assignment of the function1 inputs:**
The safety function which is triggered by the function 1 input can be selected here. The following safety functions are available:
 - **no function:**
The safety input is not assigned with a safety function.
 - **STO:**
The safety function „Safe Torque Off“ is carried out => [11.3](#).
 - **SBC:**
The safety function "Safe Brake Control" is carried out => [11.4](#).
 - **SS1:**
The safety function "Safe Stop 1" is carried out => [11.5](#).
 - **SS2:**
The safety function "Safe Stop 2" is carried out => [11.6](#).
 - **SOS:**

The safety function "Safe Operating Stop" is carried out => [11.7](#).

- **SLS:** The safety function "Safely-Limited Speed" is carried out => [11.8](#).
- **SLP:** The safety function "Safely-Limited Position" is carried out => [11.9](#).
- **Set SLP reference point:**
The safety function "Set Safely-Limited Position of reference position" is carried out => [11.9](#).
- **SLI activation:**
When the input is active, the SLI function is **not** active. If the function is not selected or the input is not active, the safety function "Safely-Limited Increment" is carried out in addition to other selected safety functions => [11.11](#).
- **SLI Next Step:**
Sets the input "SLI Next Step" for the safety function "Safely-Limited Increment" => [11.11](#).
- **SDI forward:**
The safety function "Safe Direction" is carried out => [11.12](#).
- **SDI reverse:**
The safety function "Safe Direction" is carried out => [11.12](#).
- **SSM:**
The safety function "Safe Speed Monitor" is carried out => [11.13](#).
- **SLA:**
The safety function "Safe Limited Acceleration" is executed => [11.15](#).
- **Reset Fail safe:**
If a safety function detects an error, e.g. because limits have been exceeded, then the fail safe bit is set in the status. The reset is carried out when the voltage at the input is switched off.

- **Subindex Bit 0, 1, 2:**
Many safety functions have indices. This allows up to 8 possible configurations to be stored, depending on the operating mode. With the correspondingly configured inputs (subindex bit 0, 1, 2), these configurations can be activated in accordance with Index selection via configurable inputs (Table 8). Alternatively, change-over is also possible via FSoE.

Index	Value	Input 3 (Bit 2)	Input 2 (Bit 1)	Input 1 (Bit 0)
Index 1	0	0	0	0
Index 2	1	0	0	1
Index 3	2	0	1	0
Index 4	3	0	1	1
Index 5	4	1	0	0
Index 6	5	1	0	1
Index 7	6	1	1	0
Index 8	7	1	1	1

Table 10: Index selection via configurable inputs

- **Tolerance time of the function1 inputs:**
The function1 input is designed as two-channel system. This can cause that a channel is switched earlier or later than the second channel. Enter a tolerance time here to ensure that this does not immediately result in an error.
- **State of the function1 inputs:**
The input state between the two channels is antivalent or equivalent:
 - At equivalent input FUNC1.1 and FUNC1.2 must always be switched simultaneously. It is not allowed to supply a channel with 24V input voltage and the other channel with 0V. The safety function is carried out if the input voltage is 0V.
 - At antivalent one channel must be supplied always with 24V and the other channel with 0V.
The following applies:
 - The safety function is not carried out if func.1.1 is supplied with an input voltage of 24V.
 - The safety function is carried out if func.1.1 is supplied with an input voltage of 0V.

8.6 Function2 hardware input configuration

The function1 input of the safety module can be used for different safety functions. The safety function to be executed can be parameterized with the parameters according Figure 30.

Parameter	Value	Unit
Function2 Hardware input configuration		
Configuration of the Function2-Inputs	Hardware input disabled	
Tolerance time of the Function2-Inputs	0.010000	s
Status of the Function2-Inputs	equivalent	

Figure 30: Parameters for the function2 input

Parameterization

- **Assignment of the function1 inputs:**

The safety function which is triggered by the function 2 input can be selected here. The following safety functions are available:

- **no function:**
The safety input is not assigned with a safety function.
- **STO:**
The safety function „Safe Torque Off“ is carried out => [11.3](#).
- **SBC:**
The safety function "Safe Brake Control" is carried out => [11.4](#).
- **SS1:**
The safety function "Safe Stop 1" is carried out => [11.5](#).
- **SS2:**
The safety function "Safe Stop 2" is carried out => [11.6](#).
- **SOS:**
The safety function "Safe Operating Stop" is carried out => [11.7](#).
- **SLS:** The safety function "Safely-Limited Speed" is carried out => [11.8](#).
- **SLP:** The safety function "Safely-Limited Position" is carried out => [11.9](#).
- **Set SLP reference point:**
The safety function "Set Safely-Limited Position of reference position" is carried out => [11.9](#).
- **SLI activation:**
When the input is active, the SLI function is **not** active. If the function is not selected or the input is not active, the safety function "Safely-Limited Increment" is carried out in addition to other selected safety functions => [11.11](#).
- **SLI Next Step:**
Sets the input "SLI Next Step" for the safety function "Safely-Limited Increment" => [11.11](#).
- **SDI forward:**
The safety function "Safe Direction" is carried out => [11.12](#).
- **SDI reverse:**
The safety function "Safe Direction" is carried out => [11.12](#).
- **SSM:**
The safety function "Safe Speed Monitor" is carried out => [11.13](#).
- **SLA:**
The safety function "Safe Limited Acceleration" is executed => [11.15](#).
- **Reset Fail safe:**
If a safety function detects an error, e.g. because limits have been exceeded, then the fail safe bit is set in the status. The reset is carried out when the voltage at the input is switched off.
- **Subindex Bit 0, 1, 2:**

Many safety functions have indices. This allows up to 8 possible configurations to be stored, depending on the operating mode. With the correspondingly configured inputs (subindex bit 0, 1, 2), these configurations can be activated in accordance with Index selection via configurable inputs (Table 8). Alternatively, change-over is also possible via FSoE.

Index	Value	Input 3 (Bit 2)	Input 2 (Bit 1)	Input 1 (Bit 0)
Index 1	0	0	0	0
Index 2	1	0	0	1
Index 3	2	0	1	0
Index 4	3	0	1	1
Index 5	4	1	0	0
Index 6	5	1	0	1
Index 7	6	1	1	0
Index 8	7	1	1	1

Table 11: Index selection via configurable inputs

- **Tolerance time of the function2 inputs:**
The function1 input is designed as two-channel system. This can cause that a channel is switched earlier or later than the second channel. Enter a tolerance time here to ensure that this does not immediately result in an error.
- **State of both function2 inputs:**
The input state between the two channels is antivalent or equivalent:
 - At equivalent input FUNC2.1 and FUNC2.2 must always be switched the same. It is not allowed to supply a channel with 24V input voltage and the other channel with 0V. The safety function is carried out if the input voltage is 0V.
 - At antivalent one channel must be supplied always with 24V and the other channel with 0V input voltage. The following applies:
 - The safety function is not carried out if func.2.1 is supplied with an input voltage of 24V.
 - The safety function is carried out if func.2.1 is supplied with an input voltage of 0V.

8.7 Ripple hardware input configuration

The ripple inputs are intended for the connection with the ripple outputs of another safety module. However, these inputs can also be used as normal inputs if parameter "the safety module is the ripple master" in the ripple output configuration is set to "on" (see chapter 9.2).

Parameter	Value	Unit
Ripple Hardware input configuration		
Configuration of the Ripple-Inputs	Hardware input disabled	
Tolerance time of the Ripple-Inputs	0.010000	s

Figure 31: Parameter for the ripple input

Parameterization

- **Assignment of the ripple inputs:**

The safety function which is triggered by the ripple input can be selected here. The following safety functions are available:

- **no function:**
The safety input is not assigned with a safety function.
- **STO:**
The safety function „Safe Torque Off“ is carried out => [11.3](#).
- **SBC:**
The safety function "Safe Brake Control" is carried out => [11.4](#).
- **SS1:**
The safety function "Safe Stop 1" is carried out => [11.5](#).
- **SS2:**
The safety function "Safe Stop 2" is carried out => [11.6](#).
- **SOS:**
The safety function "Safe Operating Stop" is carried out => [11.7](#).
- **SLS:** The safety function "Safely-Limited Speed" is carried out => [11.8](#).
- **SLP:** The safety function "Safely-Limited Position" is carried out => [11.9](#).
- **Set SLP reference point:**
The safety function "Set Safely-Limited Position of reference position" is carried out => [11.9](#).
- **SLI activation:**
When the input is active, the SLI function is **not** active. If the function is not selected or the input is not active, the safety function "Safely-Limited Increment" is carried out in addition to other selected safety functions => [11.11](#).
- **SLI Next Step:**
Sets the input "SLI Next Step" for the safety function "Safely-Limited Increment" => [11.11](#).

- **SDI forward:**
The safety function "Safe Direction" is carried out => [11.12](#).
- **SDI reverse:**
The safety function "Safe Direction" is carried out => [11.12](#).
- **SSM:**
The safety function "Safe Speed Monitor" is carried out => [11.13](#).
- **SLA:**
The safety function "Safe Limited Acceleration" is executed => [11.15](#).
- **Reset Fail safe:**
If a safety function detects an error, e.g. because limits have been exceeded, then the fail safe bit is set in the status. The reset is carried out when the voltage at the input is switched off.
- **Subindex Bit 0, 1, 2:**
Many safety functions have indices. This allows up to 8 possible configurations to be stored, depending on the operating mode. With the correspondingly configured inputs (subindex bit 0, 1, 2), these configurations can be activated in accordance with Index selection via configurable inputs (Table 8). Alternatively, change-over is also possible via FSoE.

Index	Value	Input 3 (Bit 2)	Input 2 (Bit 1)	Input 1 (Bit 0)
Index 1	0	0	0	0
Index 2	1	0	0	1
Index 3	2	0	1	0
Index 4	3	0	1	1
Index 5	4	1	0	0
Index 6	5	1	0	1
Index 7	6	1	1	0
Index 8	7	1	1	1

Table 12: Index selection via configurable inputs

- **Tolerance time of the ripple inputs:**
The ripple input is designed as two-channel system. This can cause that a channel is switched earlier or later than the second channel. Enter a tolerance time here to ensure that this does not immediately result in an error.

9 Outputs

The safety module has 2 configurable outputs, a clock output, and a ripple output to network the safety module with other safety modules.

9.1 Safe output 1 & 2

Figure 32 displays the parameters of the output configuration. The switch-OFF and ON delay affects generally output 1 and output 2.

NOTICE

Interruption of the OSSD signals by function test!

- In order to check the switch-off capability of the output channel, an interruption of up to 2 ms takes place twice approx. every 30 min.
- If no voltage drop is detected at the output after 2 ms, the module changes into the safe state.

Parameter	Value	Unit
Configuration of outputs 1 and 2		
Configuration of Output1	1	
Configuration of Output2	32	
Switch off delay time	1.000000	s
Switch on delay time	1.000000	s

Figure 32: Parameters of the output configuration

Parameterization

- **Output1 configuration:**
- **Output2 configuration:**

The output can be switched on upon execution of safety functions. The following values can be arbitrary combined and set as output configuration. The output configuration is "OR connected".

As an example for an "OR connection" see the example SLS or SSM. If the output shall be set when one of the two safety functions is executed, then value 32 must be set for SLS and value 2080 for SSM. This amounts to 2080.

The following options are available:

Value	Plaintext	Note
0	No function	The output is not used.
1	STO	The output is switched on when the safety function STO is executed.
2	SBC	The output is switched on if the safety function SBC is executed.
4	SS1	The output is switched on when the safety function SS1 is executed.
8	SS2	The output is switched on when the safety function SS1 is executed.
16	SOS	The output is switched on when the safety function SOS is executed.

Value	Plaintext	Note
32	SDIR	The output is switched on when the safety function SDI forward is executed.
64	SDIL	The output is switched on when the safety function SDI backwards is executed.
128	Error safety function	If an error occurred during the execution of a safety function, then the output is switched on.
256	SLS	The output is switched on when the safety function SLS is executed.
512	SLA	The output is switched on when the safety function SLA is executed.
1024	SLP (activation)	The output is switched on when the safety function SLP is executed.
2048	SLP Reference position	The output is switched on when the safety function SLP reference position is executed.
4096	SEL	The output is switched on when the safety function SEL is executed.
8192	SLI activation	The output is switched on when the safety function SLI activation is executed.
16384	SLI Next step	The output is switched on when the safety function SLI Next step is executed.
32768	SSM	The safe output is switched off if the value of the parameterized speed plus hysteresis is exceeded. The safe output is only set if the value falls below the parameterized speed plus hysteresis.
65536	SMS	The output is switched on when the safety function SMS is executed.

- **ON delay:**
This delays the switching on of the output when the safety function is activated.

9.2 Ripple outputs

The safety module has a ripple output which can be connected with the ripple inputs of another safety module. The ripple output is designed as two-channel system. The ripple output can be used as normal output if parameter "ripple master" is set to on. However, observe that the behavior of the ripple outputs is reverse to the normal outputs. This means, if the safety function is active then the ripple outputs are switched 0, and if the safety function is not active then the ripple outputs are switched to 1.

Examples of interconnections and the startup behavior can be found in chapter [13.2](#).

Figure 33 displays the configuration options for the ripple output.

Parameter	Value	Unit
Ripple output configuration		
Configuration of the Ripple-Output	2080	
Ripple Master	off	
Cycle time	5.000000	s

Figure 33: Ripple output configuration settings

Parameterization

- **Ripple output configuration:**
The output is switched off during the execution of the configured safety functions. You can configure any safety functions simultaneously. The options are the same as for the safe outputs.
- **Ripple master:**
If this safety module is not part of a closed ripple chain, then this adjustment must be set to "on". The ripple output can be used as additional output with this adjustment. The output is switched off when the configured safety function is executed.
- **Cycle time:**
The ripple cycle time is the max. time which is required by the signal to run from this safety module once through the ripple chain and back to the inputs. The ripple cycle time results from:
maximum switch-on delay ripple inputs: 2ms + maximum switch-on delay ripple outputs: 448us + maximum delay time for the ripple outputs: 750us = 3.2ms
The ripple cycle time must be multiplied with the number of users, furthermore the filter time for the ripple inputs must be added.

9.3 Clock-output

In order to detect dangerous external line short circuits between two related inputs and/or to voltage supply potentials, mechanical contact pairs are supplied via phase-shifted clock outputs. The cyclic clock signals are evaluated by the safe inputs of the control module. Control internal cross circuits are detected by the sequential test of the input circuits.

9.3.1 Clock output configuration

Parameter	Value	Unit
Clock output configuration		
Period of the Clock-Output	7.000000	s
Pulse length of the Clock-Output	0.001000	s

Figure 34: Clock output configuration in COMBIVIS

Parameterization

- **Cycle duration of the clock outputs:**
The cycle duration for the clock outputs is the time interval of a test pulse to the next.
- **Pulse length of the clock outputs:**
The pulse length is the time for a test pulse.

9.3.2 Recommended adjustments for the cycle duration of the clock outputs

With cyclic switching operations the cycle duration should always be shorter than the cyclic switching operation. If the demand for a safety function occurs every 10s, then the cycle duration must be shorter than 10s, otherwise it is possible that the clock pulse is never be examined by the safety module, if this occurs exactly simultaneously with the cyclic switching. Or the cyclic switching is held for the clock pulse and thus the safety module changes into the error state.

10 Encoder configuration

10.1 Encoder selection

Two encoder types can be connected.

- Sine/cosine encoder
- Resolver

Parameter	Value	Unit
Encoder configuration		
Connected encoder	Resolver	
Window for maximum difference	50	%
Allowed position difference between the input channels	10	°

Figure 35: General encoder configuration

Parameterization

- **Connected encoder:**
The connected encoder can be a sine/cosine encoder, resolver or no encoder.
- **Window for maximum deviation:**
The sine and cosine signal of the encoder, is checked via a $\sin^2x + \cos^2x = 1$ evaluation for errors. Since no encoder is ideal, there may be differences. The following formula is valid for deviations: $\sin^2x + \cos^2x = (1 \pm \text{window for max. deviation (\%)})$. A tolerance range of 50% is recommended in the manual for the SICK SKM36S-HFA0-K02 encoder referred in chapter [10.2](#).
- **Permitted position difference between the input channels:**
The safety module has two independent input channels for the evaluation of the position data. This can cause minor deviations between the two channels. This value can be adjusted if there are problems during operation with a suitable encoder. A value of 10° is entered here as standard.

NOTICE

Loose the encoder from the motor housing!

- In order to be able to apply the fault exclusion against loosening of the encoder housing from the motor housing or the encoder shaft from the motor shaft, the permissible load of the sensor must be known or limited to the specifications in the data sheet. A distinction is made between form-fitting and frictional connections.

10.2 Use sine/cosine encoder

NOTICE

Only SIL certified sine/cosine encoders must be used!

- Only SIL certified sine/cosine encoder must be used. The installation & mounting instructions for the encoder must be observed. The encoder must have an amplitude of 1V_{ss} and an offset of 2.5V. The increments per revolution may not be higher than 16000 increments.

We recommend the SICK SKM36S-HFA0-K02 encoder as sine/cosine encoder. This encoder has 128 increments and no zero track. The maximum input frequency of the encoder evaluation is 200kHz.

Parameter	Value
Sine Cosine encoder configuration	
Dash count	128
Allowed position difference	1
Check of zero pulse	off

Figure 36: Encoder configuration in COMBIVIS

Parameterization

- **Increments per revolution:**
The increments per revolution of the sine/cosine encoder according to data sheet.
- **Permitted position deviation:**
The safety module checks internally whether there are wrong increments during the run-time of the safety module. Furthermore, it is checked whether a position deviation to the zero pulse track was detected. If wrong increments or a position deviation to zero pulse track has been detected which is higher than the permitted position deviation, then the safety module changes into the safe state.
The input of this parameter is done in full increments.
- **Evaluation of the zero pulse track:**
Only if the encoder has a zero pulse track, this can be evaluated.

The evaluation of the zero pulse track should be adjusted only if a sine/cosine encoder with zero pulse track is used. It is checked whether the counted increments agrees with the zero pulse and the adjusted increments.

Since a possible position error can be varied via parameter position deviation, the resolution of the safe position should not be lower than the parameter.

$$\text{max. possible position deviation} [^\circ] = \frac{\text{permitted position deviation}}{\text{increments}} \cdot 360^\circ$$

10.3 Use of resolvers

NOTICE

Use resolver with permanent fixing!

- The proof of endurance strength of mechanical fixing is required for the resolver.
- This condition is fulfilled for KEB DL3 motors.

10.3.1 maximum permissible speed

The maximum permissible speed is limited by the software to 25000 rpm.

10.3.2 Phase shifting of the signals

Furthermore, the resolver may not exceed the indicated phase shiftings:

1. The phase shifting between sine and cosine channel of the resolver may be maximally -54 degrees and +72 degrees. Also the phase shifting between the reference signal of the stator winding to the sine and cosine channel must not be lower than -54 degrees and higher than 72 degrees.
2. An error in the resolver is detected at a phase shifting higher than 72 and lower than 126 degrees. The safety module is changed into the safe state.
3. No error is detected at a phase shifting higher than 126 degrees and lower than 252 degrees, but the detected direction of rotation is inverted.
4. An error is detected in the resolver at phase shifting higher than 252 degrees and lower than 306 degrees. The safety module is changed into the safe state.

10.3.3 Position error

The position error which can be available from checking of the function $\sin^2x + \cos^2x = 1$ +- window for max. deviation (%)/100%) is:

$$\text{max. possible error position} = \arctan \left(\sqrt{\frac{\text{window for max. deviation (\%)}}{100\%}} \right)$$

The safe position resolution should be higher than the maximum possible error position.

10.4 Scaling settings for the position, encoder settings for the input channels

Parameter	Value	Unit
Position scale		
Number of bits per revolution (bpr)	16	bit

Figure 37: Encoder settings for the input channels

Parameterization

- Number of bits per revolution (Ps):**
 Position limits can be specified for the safety functions SDI, SOS, SLI, SLP reference position and SLP safe limited position. These are always in the format "bits per revolution". 16-bit are entered here as standard, that means, a value of 2^{16} corresponds to 1 revolution or 360 degrees. By increasing the value positions can be entered more precisely. By reducing the value, larger but less precise positions can be entered.

10.5 Encoder settings for speed detection

NOTICE

Response time of the safety functions!

- The response time of the safety functions SS1, SS2, SLS and SSM is directly related to the encoder adjustments for speed detection. Higher scan times provide a smooth speed, but also a slower response time of the safety functions.

Restart only after confirmation

- The drive restarts if function STO is no longer released. In order to comply with EN 60204-1, it must be ensured by external measures that the drive restarts only after confirmation.

Parameter	Value	Unit
Settings for the speed measurement		
Speed scan time	1 ms	
Speed PT1-time	2.000000	ms

Figure 38: Encoder settings for speed measurement

Parameterization

- Speed PT1 time:**
 The speed can be filtered by a PT1 filter. The setting of 0 means no PT1 filter is used. The setting of 256 ms means (maximum value), a PT1 filter of 256 ms is used.
- Speed scan time:**

The speed is determined by the following formula: Position – position (speed scan time) / speed scan time. Position errors are filtered at higher speed scan time, but the response time is slower.

10.5.1 Speed scan time

The speed scan time provides a delay of the speed change. Thereby at a speed jump the actual speed is reached only after the speed scan time.

$$y = \frac{\Delta \text{encoder position}}{\text{speed scan time}}$$

y = determined speed safety module.

Δ Encoder position = position difference of the actual position compared to the position before speed scan time

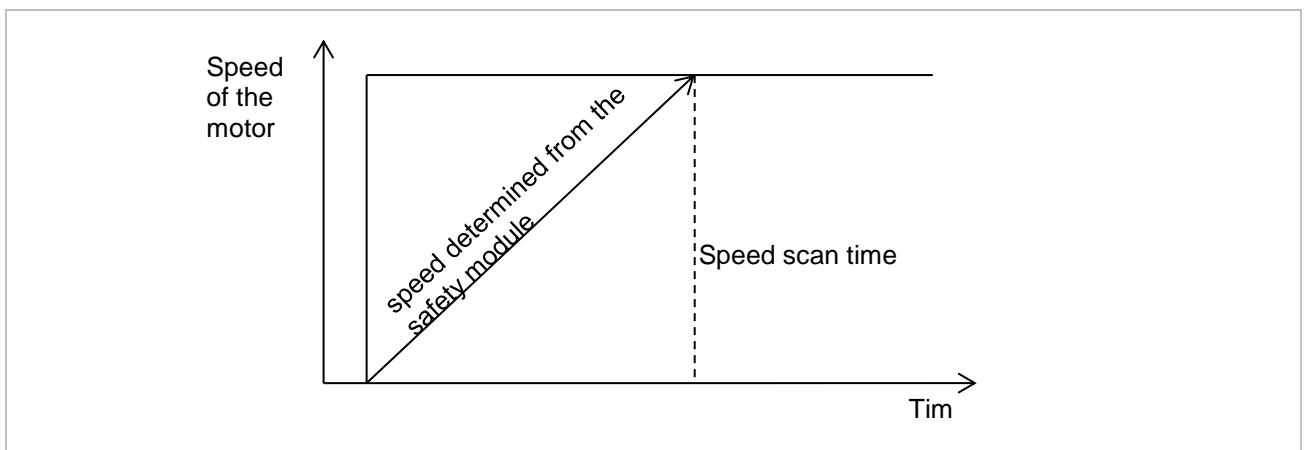

Figure 39: Speed scan time related to the speed

10.5.2 Speed PT1 time

The speed PT1- time provides a delay of the speed change. Thereby at a speed jump the actual speed is reached only after the speed PT1-time is reached.

$$y = y_{t-1} + \frac{t}{T}(x(\text{encoder}) - y_{t-1})$$

y = determined speed safety module.

x (encoder) = speed from speed scan time detection.

y (t-1) = determined speed from the safety module for the last time

T = speed PT1- time

t = time of calculation (the speed of the safety module is calculated in steps of 250 μ s).

Figure 40 shows the behavior specified according to the formula. PT1_KEB is the behavior of the algorithm in time discrete case. A step of PT1_KEB is 250 μs.

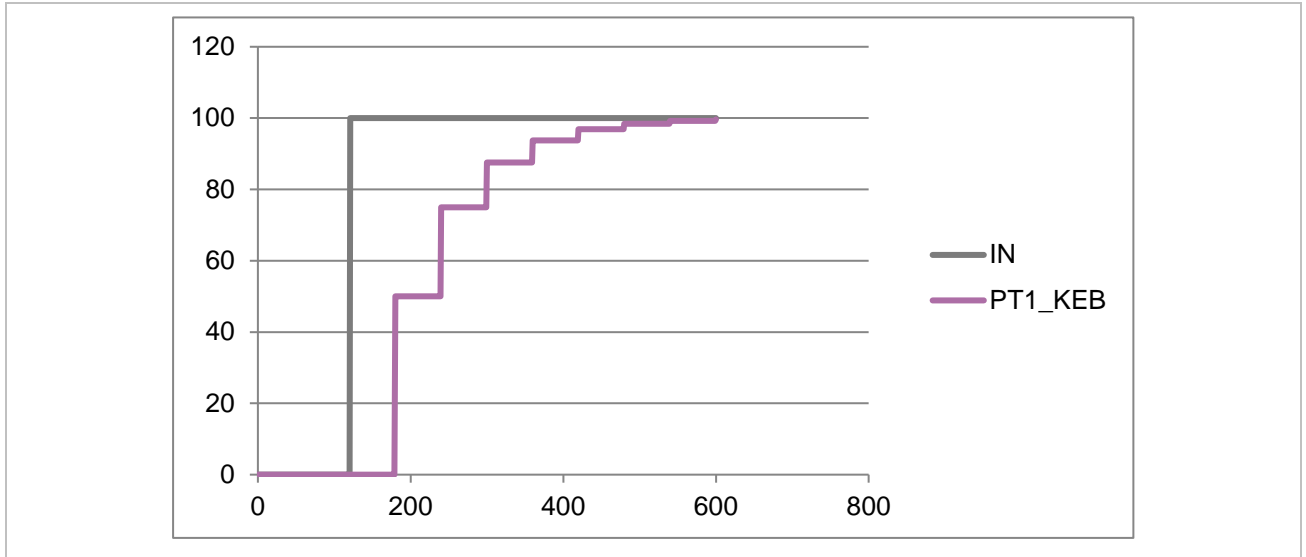

Figure 40: Speed PT1-time related to a speed jump

10.5.3 Speed scan time + speed PT1-time

The behavior of the speed scan time with the speed PT1 time is displayed in Figure 41. The speed jump is decelerated first by the speed scan time. The speed PT1 - is used to this filtered speed change. A step of PT1_KEB is 250 μs.

$$y = y_{t-1} + \frac{t}{T} \left(\frac{\Delta encoder\ position}{speed\ scan\ time} - y_{t-1} \right)$$

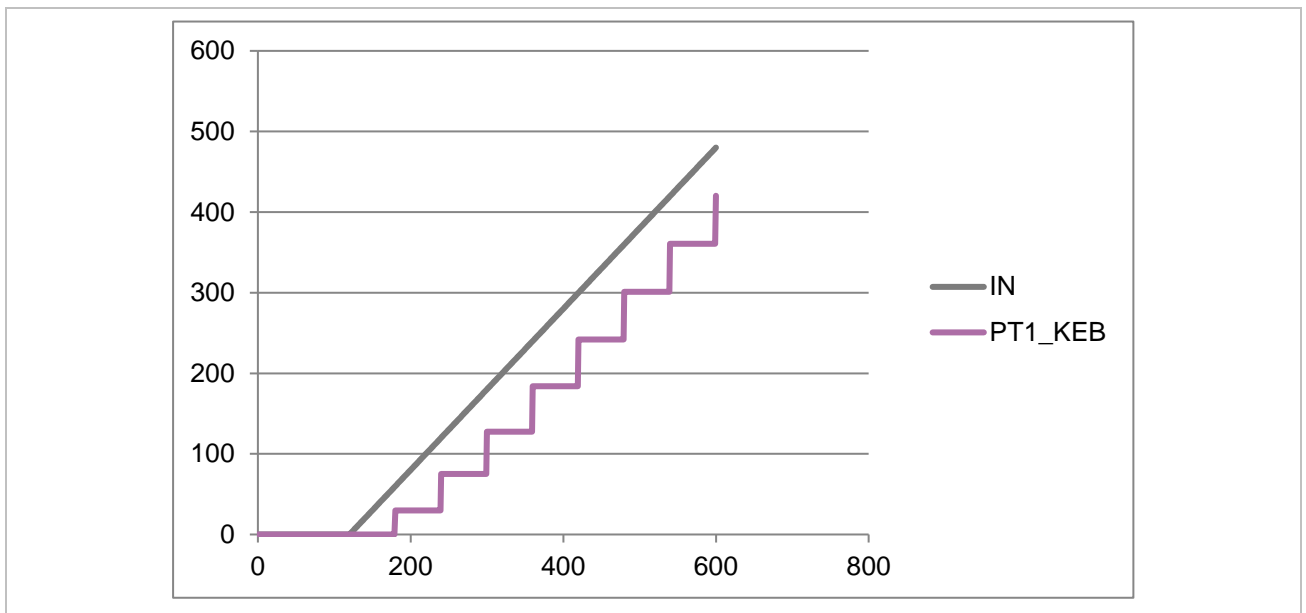

Figure 41: Speed scan time and speed PT1 time together

11 Functional description of the safety functions

The safety module fulfills the following functions listed in this chapter according to IEC 61800-5-2.

11.1 Priority of the safety functions

STO always has the highest priority. The other safety functions all have the same priority.

Priority	Meaning
0	STO is executed, modulation not released. See chapter 11.3.

Table 13: Priority of the safety functions of the safety module

11.2 Status of the safety module

The status of the safety module can be read out with parameter sb29 "safety mod. status word" of the COMBIVERT. The parameter is bit-coded in accordance with the following table:

Bit	Condition	Meaning
0	Status „1“	error in the safety module
1	Status „0“	STO is executed, modulation not released (=> 11.3).
2	Status „0“	SBC is executed. Brake closed (=> 11.4).
3	Status „1“	SS1 is executed (=> 11.5)
4	Status „1“	SS2 is executed (=> 11.6)
5	Status „1“	SOS is executed (=> 11.7)
6	Status „1“	SDI forward is executed (=> 11.12)
7	Status „1“	SDI reverse is executed (=> 11.12)
8	Status „1“	Fail Safe. The limit of an active safety function has been breached.
9	Status „1“	SLS is executed (=> 11.8)
10	Status „1“	SLA is executed (=> 11.15)
11	Status „1“	SLP is executed (=> 11.10)
12	Status „1“	SLP Set Reference Position (=> 11.9)
13	Status „1“	SEL is executed (=> 11.10.1)
14	Status „1“	SLI is executed (=> 11.11)
15	Status „1“	Activation of a safe increment of the SLI function (=> 11.11)
16	Status „1“	SSM is executed (=> 11.13)
17	Status „1“	SMS is executed (=> 11.14)

Table 14: Status of the safety module

11.3 Functional description Safe Torque Off (STO)

The safety-related disconnection according to STO is reached by a two-cannel opto-coupler blockage. This ensures that supply of the opto-couplers also is not possible at STO execution. If the opto-couplers are not longer supplied, no IGBT can be controlled and thus no rotation energy can be supplied to the drive.

- STO status is displayed in status bit 1.

Installation work or troubleshooting can be necessary in hazard areas, whereby protective devices such as line- or motor contactors shall not be activated. The safety function STO can be used there. Depending on the application the use of line or motor contactors can be void by using STO.

In case of error or request, the power semiconductor of the drive module are switched off and the drive is not supplied, which causes a rotation or torque (in case of a linear drive movement or force). The unit can be safe switched off and/or remain if an error occurs.



**Continue mains voltage with active STO function!
Electric Shock!**

- When carrying out work on the unit or motor disconnect it from the mains supply.

11.3.1 Emergency stop in accordance with EN 60204

By using suitable safety relays, stop category 0 according to EN 60204-1 can be reached in the system by the STO function.

Stop category 0

- „uncontrolled stop“, i.e. stop by immediate removal of power to the actuators.

Emergency stop to EN 60204 must be functional in all operating modes of the drive module. The reset of emergency stop may not lead to an uncontrolled start of the drive.

Restart only after confirmation

- The drive restarts if function STO is no longer released. In order to comply with EN 60204-1, it must be ensured by external measures that the drive restarts only after confirmation.

Without mechanical brake the drive leads to coast; motor is free-wheeling. Additional protective devices must be installed (e.g.locking systems) if damage to persons or property can occur.



Ensure coast of the motor!

- If danger to persons occur after switching off the motor control by STO, the entrance to hazard areas must remain closed until the drive stops.



Jerks in error case!

-
- In case of double malfunction it can lead to unwanted jerks, the rotation angle is depending on the number of poles of the selected drive and the gear ratio.
-

Calculation of the jerk:

$$\text{Rotation angle of the jerk } W_R [^\circ] = \frac{180^\circ}{\text{pole pair number } p \cdot \text{gear reduction ratio } g}$$

Formula 1: Calculation of the jerk

The probability of the jerk is $< 1.84 \cdot 10^{-15}$ 1/h.

This behaviour can occur either by a short circuit of the IGBTs or by interconnection (also short circuit) of the control drivers. The error should be regarded as critical, if the drive remains in STO status.

11.3.2 Error response times STO function

Technical data of the STO function	
Maximum switch-on delay (+ filter time for the safety input + pulse length for the input analysis)	< 3 ms
Maximum switch-off delay (+ filter time for the safety input + pulse length for the input analysis)	< 3 ms

11.4 Functional description Safe Brake Control (SBC)

The safe brake control is exclusively defined for brakes which are active in de-energized condition. These brakes are opened by applying a voltage, so that a single fault, such as the failure of the power supply, may not lead to the loss of the safety function.

The circuit operates on two channels. The brake can only be opened by the control in COMBIVERT if the safety function SBC is no longer executed. Then opening the brake is displayed with "Brake status" in status bit 2 (1 means brake open).

The two channels are realized with a diverse high-side and low-side switch. These are tested on their switching ability each hour.

11.4.1 Requirements for the brake

Voltage supply	DC 24 V ±10 %
max. current	DC 3.3 A
Free-wheeling circuit	integrated in COMBIVERT

NOTICE

Power-off braking!

- Use brakes which are closed at power-off state.

A classification of the entire brake system inclusive mechanical brake to SIL 3 and PL e must be evaluated depending on the used brake. Brakes are considered as components with relatively high error probability. A test interval for the brake is set depending on the manufacturer specified error probability of the used brake and depending on the application.

NOTICE

Check the brake!

- A check of the brake can not be done by the safety module.
- The examination must be ensured by the user.

⚠ DANGER

Floating loads!

- Because of high failure probability of mechanical brakes it is not permitted to stay under hanging or floating loads. The same is valid for inertia mass, which do not stay in idle position.

11.4.2 Error response times SBC function

Technical data of the SBC function	
Maximum switch-on delay (+ filter time for the safety input + pulse length for the input analysis)	< 3 ms
Maximum switch-off delay (+ filter time for the safety input + pulse length for the input analysis)	< 3 ms

11.4.3 Setting of status bits by the SBC function

The current is measured by the brake at brake release. The following bits are set depending on the measurement:

Current measurement	Bit
>3.3 A	The error is output in the error state.
<100 mA	A warning is output in the error state.

Pay attention to response time

- Since the current increases slowly at high brake inductance, the error response time is max. 100 ms to a current <0.1A.
-

11.4.4 Monitoring of the SBC function

The switches are tested at brake release each hour on their switching ability.

For this purpose, the signals of the brake outputs are checked.

Thus a monitoring of the wiring of short circuit to 24V respectively 0V is given. If the safety module detects an error, the control of both channels is disconnected, the LED is set to red and bit 0 is set in the status.

Pay attention to response time

- The maximum error response time is 9 ms.
-

The voltage supply for switching the brake is monitored. Status bit 0 is set if the voltage is outside 24 V \pm 10 %. Also an error is output in the error status.

If the safety module is in error state is displayed in the status of the control of COMBI-VERT with parameter ru01 = "55" (error safety module).

11.4.5 Configuration parameter of the safety function SBC

Parameter	Value	Unit
SBC: Safe brake control		
Coupling of SBC with STO	off	
Measurement of the brake current	on	

Figure 42: SBC Parameters

Figure 42 specifies the configuration parameters for the SBC function.

Parameterization:

- Coupling of SBC with STO:**
 If state STO is reached for a safety function, then also the brake output is switched off simultaneously with "on". The brake closes.
- Measurement of the brake current:**
 The brake output current is measured if this option is set to "on" (default). If a current higher than 3.3 A is measured, the safety module is transferred into the safe state.

11.5 Functional description Safe Stop 1 (SS1)

The safety function SS1 can be executed in two ways

- SS1-r (former type B)
- SS1-t (former type C)

11.5.1 Activation of the safety function SS1

The circuit operates on two channels. The safety function of the control of the COMBI-VERT can only be left, if both hardware inputs are voltage supplied or if a corresponding status change has been received via a safe bus system. The SS1 status is displayed in status bit 3.

11.5.2 Configuration parameters of the safety function SS1

Parameter	Value	Unit
SS1: Safe stop 1		
Selection of the type of the function	Type B and type C	
Delta n	0.000000	1/min
Delta t	0.000000	s
Negative tolerance	0.000000	1/min
Positive tolerance	0.000000	1/min
Time window of speed deviation	0.000000	s
Type C time	0.000000	s

Figure 43: Configuration parameter for the safety function SS1

11.5.3 Error response times SS1 function

Technical data of the SS1 function	
Maximum switch-on delay (+ filter time for the safety input + pulse length for the input analysis)	< 2 ms
Maximum switch-off delay (+ filter time for the safety input + pulse length for the input analysis)	< 2 ms

Pay attention to response time

- The response time of the SS1-r function depends largely on the encoder settings for the speed measurement => Chapter [10.5](#).

11.5.4 Emergency stop in accordance with EN 60204

By using suitable safety relays, stop category 1 according to EN 60204-1 can be reached in the system by the SS1 function.

Stop category 1

- „controlled stop“, i.e. power to the actuators is retained to apply braking until the stop is achieved. The energy is only interrupted (STO) when the standstill has been reached.

11.5.5 Description of the SS1-r function

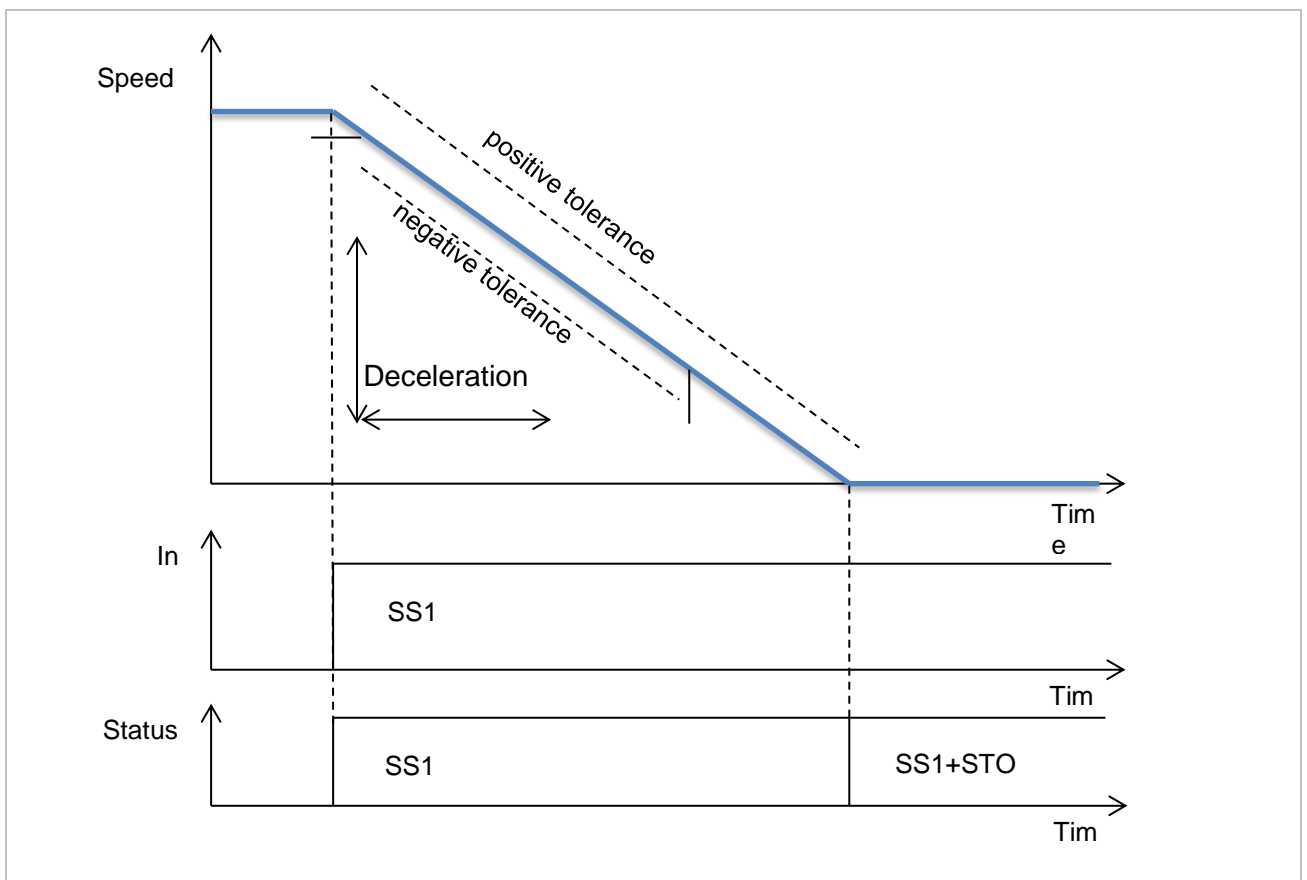

Figure 44: SS1-r safety function

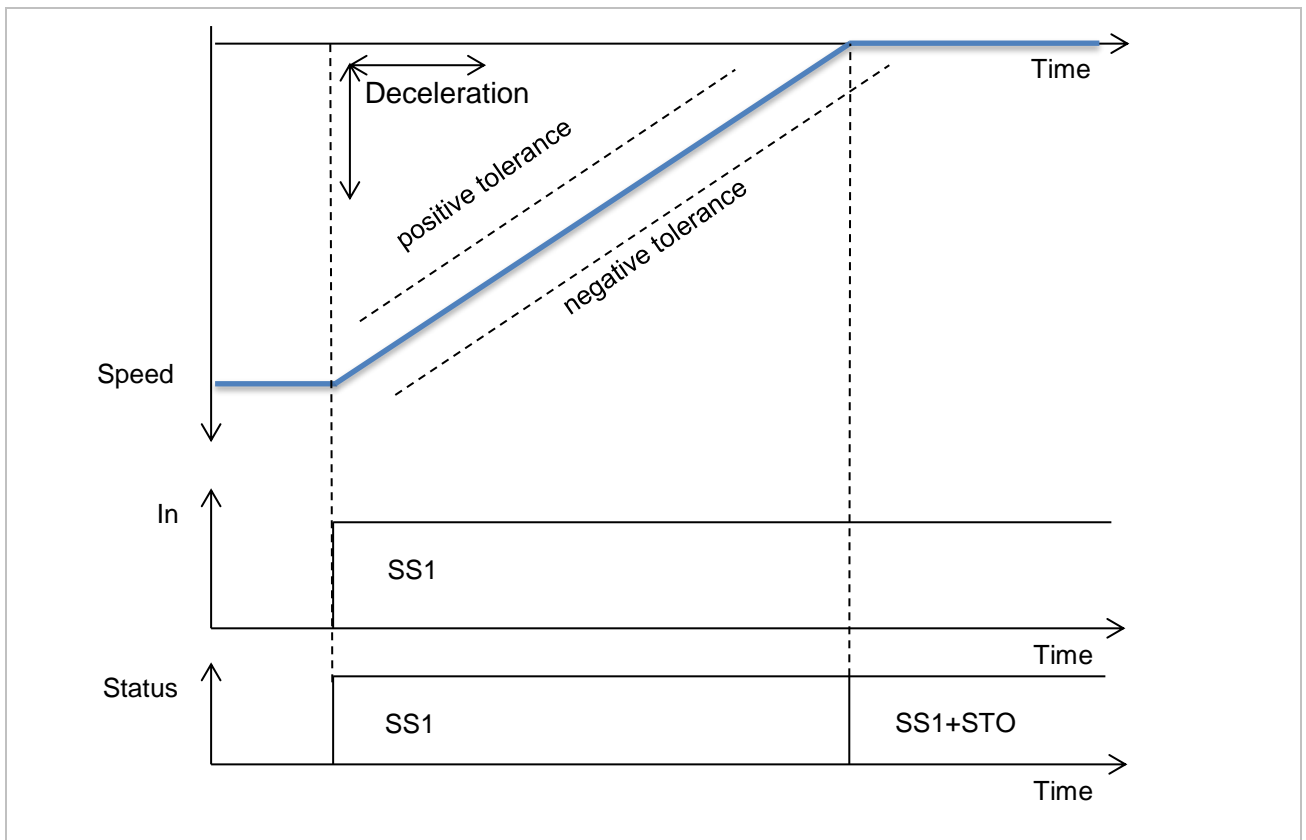

Figure 45: SS1-r with negative speed as starting value

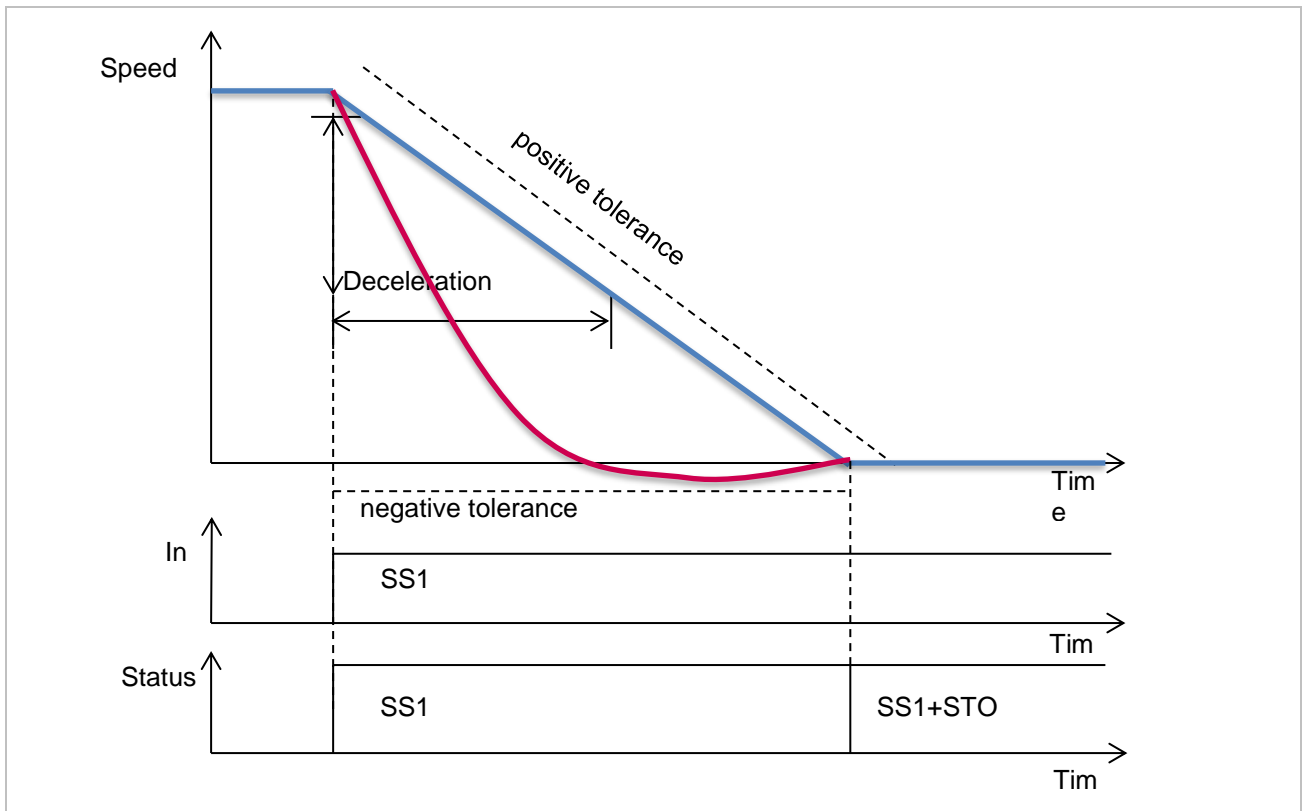

Figure 46: SS1-r Safety function with higher deceleration permissible

The brake ramp is monitored after triggering of the function.

For monitoring the braking ramp, the deceleration is monitored. State STO is assumed after reaching the standstill.

Errors are faded out via a parameter, which defines a max. tolerable time for short-term deviations from the tolerance window.

Parameterization:

- **Deceleration:**
Permits the configuration of the ramp which decelerates the motor of the COMBI-VERT.
- **Time window for speed deviation:**
 - Permits a deviation of the motor from the ramp for the adjusted time. The STO safety function is executed if the time is exceeded. A status change to FailSafe is only triggered if the time from activation SS1-r to the violation of the ramp (incl. tolerance) plus the set tolerance time is lower than the delay time specified by the set-point ramp and the output speed. If the time of activation SS1-r plus tolerance time is higher, SS1-r will detect a successful deceleration and STO is set after the deceleration time has elapsed (related to ramp and output speed) and FS is not set.
The counter is incremented when the speed is outside the speed limit. The counter is decremented when the speed is back within the speed limit.
- **Negative and positive tolerance:**
Allows to define a range, in which speed deviations are tolerated by the ramp.
- **Activated safety function:**
The SS1-r and SS1-t function or only SS1-r can be activated here.
- **Higher deceleration allowed:**
The speed must not be higher than the deceleration + positive tolerance. However, the lower speed limit is 0 - negative tolerance. Thus the drive can also decelerate faster.

If the tolerance range is left longer than the defined time in the time window, it is changed into state STO.



- From control card firmware 2.5, a stop condition can be set for SS1 and SS2 in pn80. This means, when one of the conditions is triggered, the drive automatically moves down at the ramp.

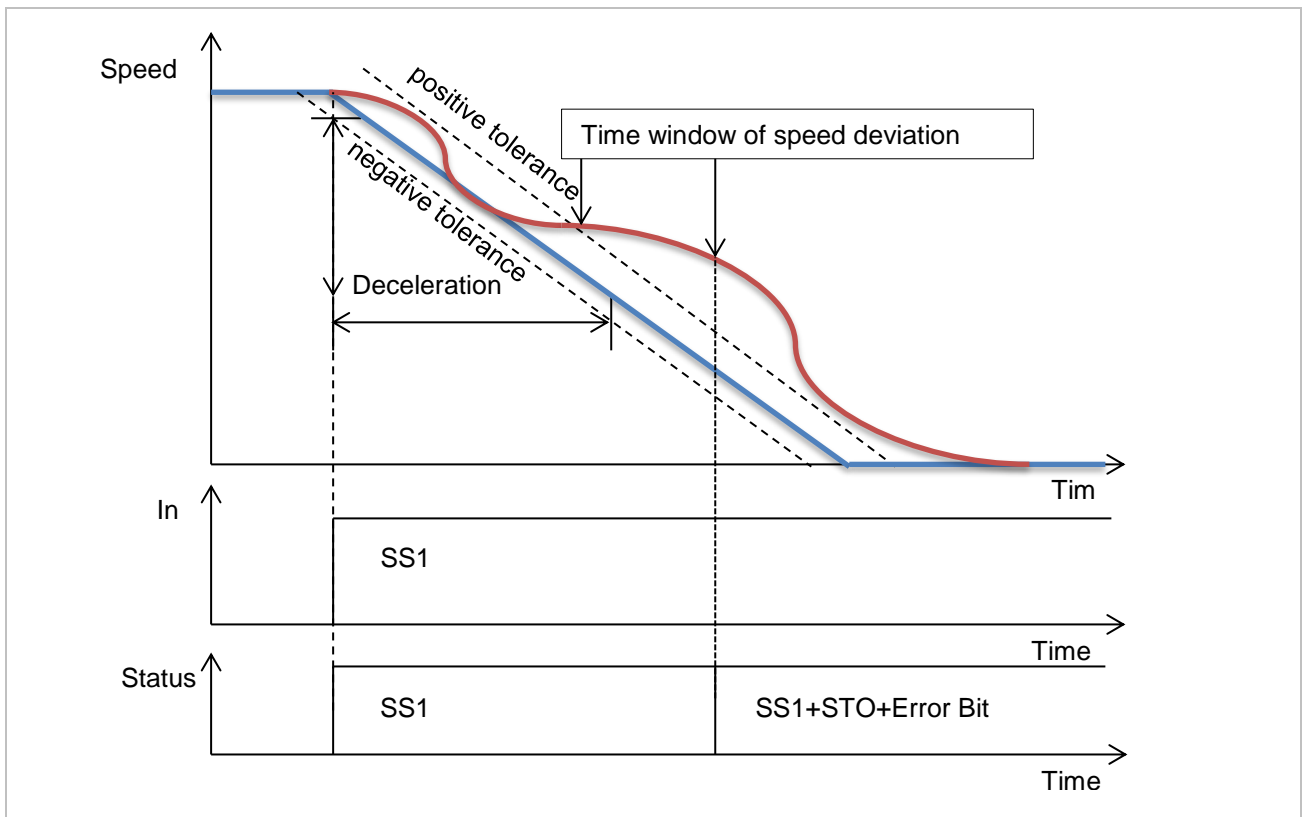

Figure 47: SS1-r Safety function with faulty ramp

11.5.6 Description of the SS1-t function

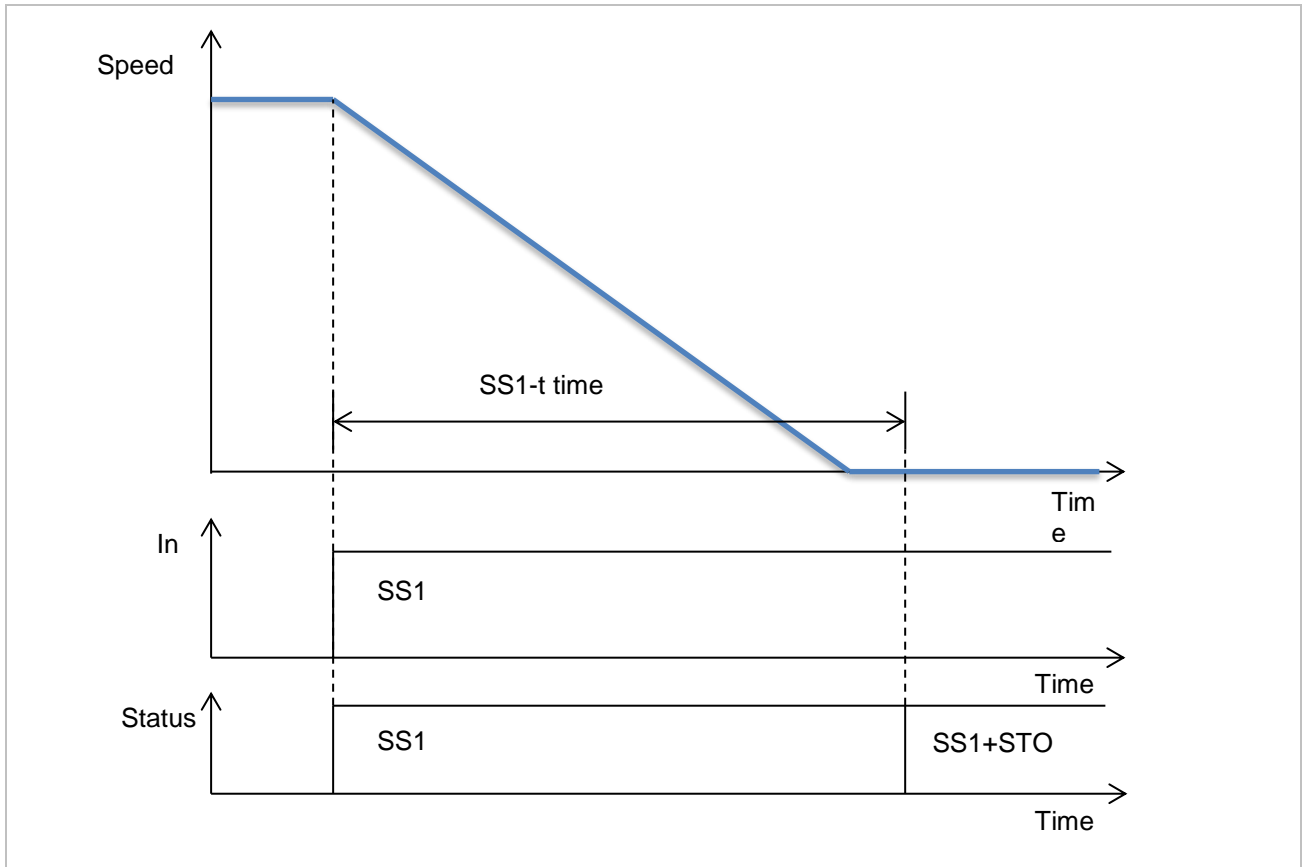

Figure 48: SS1-t Functional description

After tripping of function SS1, the drive is decelerated due to the effect of the drive control. State STO is assumed after expiration of the configurable time "time period upto safety function".

Parameterization

- **SS1-t time :**
If the entered time period has expired, the safety function STO is executed. A ramp is not monitored here.
- **Selection of the function type:**
The SS1-r and SS1-t function or only SS1-t can be activated here.

11.6 Functional description safe stop 2 (SS2)

The safety function SS2 can be executed in two ways:

- SS1-r (former type B)
- SS1-t (former type C)

11.6.1 Activation of the safety function SS1

The circuit operates on two channels. The safety function of the control of the COMBI-VERT can only be left, if both hardware inputs are voltage supplied or if a corresponding status change has been received via a safe bus system. The SS2 status is displayed in status bit 4

11.6.2 Configuration parameters of the safety function SS2

Parameter	Value	Unit
SS2: Safe stop 2		
Selection of the type of the function	Type B and type C	
Delta n	0.000000	1/min
Delta t	0.000000	s
Negative tolerance	0.000000	1/min
Positive tolerance	0.000000	1/min
Time window of speed deviation	0.000000	s
Type C time	0.000000	s

Figure 49: Configuration parameters for the safety function SS2

11.6.3 Error response times SS1 function

Technical data of the SS1 function	
Maximum switch-on delay (+ filter time for the safety input + pulse length for the input analysis)	< 2 ms
Maximum switch-off delay (+ filter time for the safety input + pulse length for the input analysis)	< 2 ms

Pay attention to response time

- The response time of the SS2 function depends largely on the encoder settings for the speed measurement (see chapter [10.5](#)).

11.6.4 Description of the SS2-r function

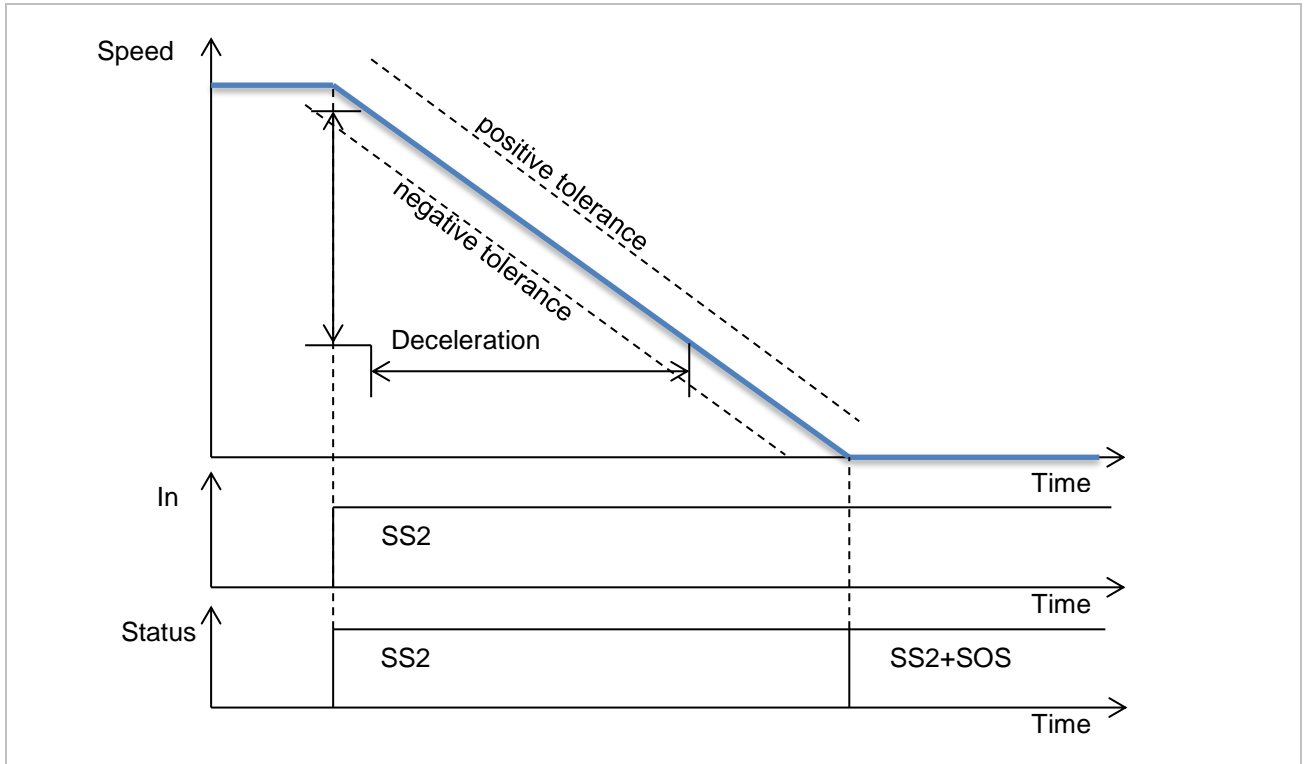

Figure 50: SS2-r safety function

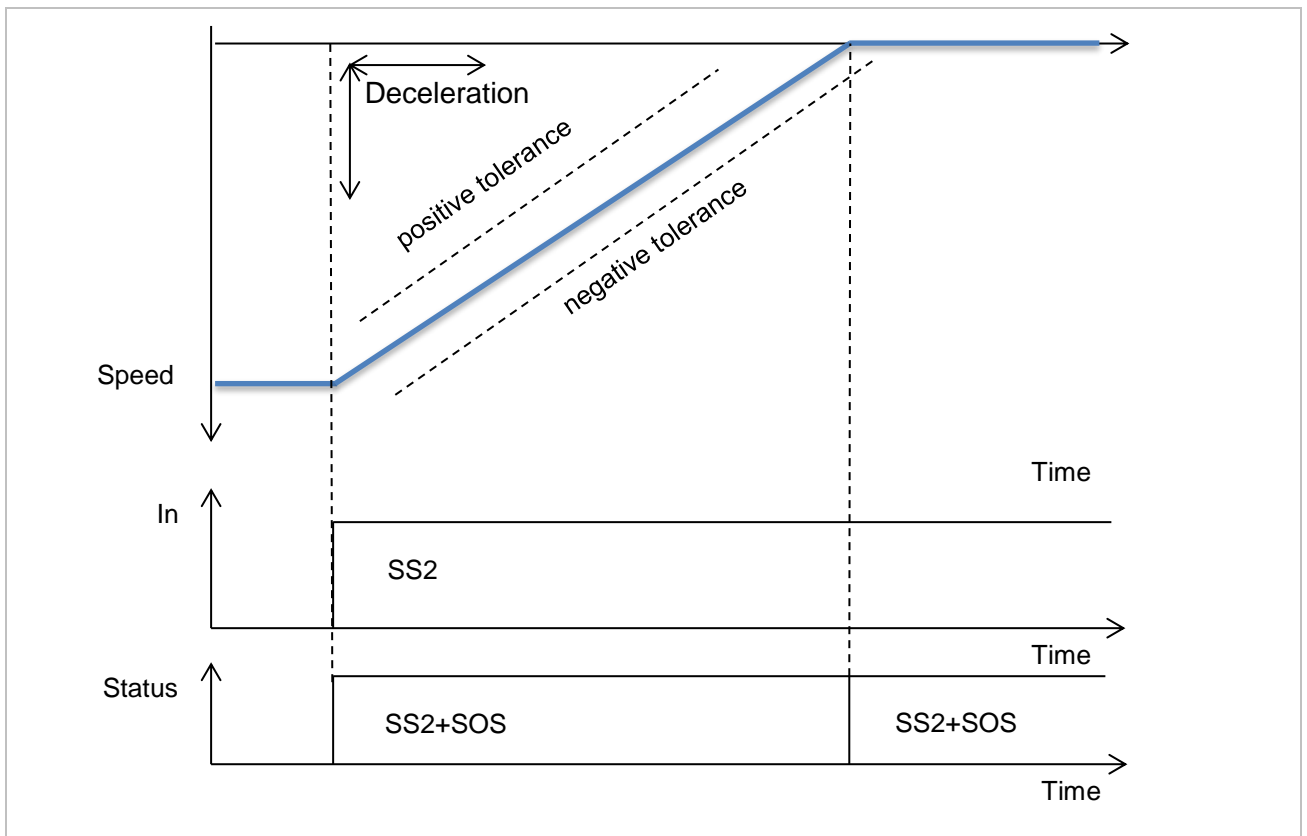

Figure 51: SS2-r safety function with negative speed

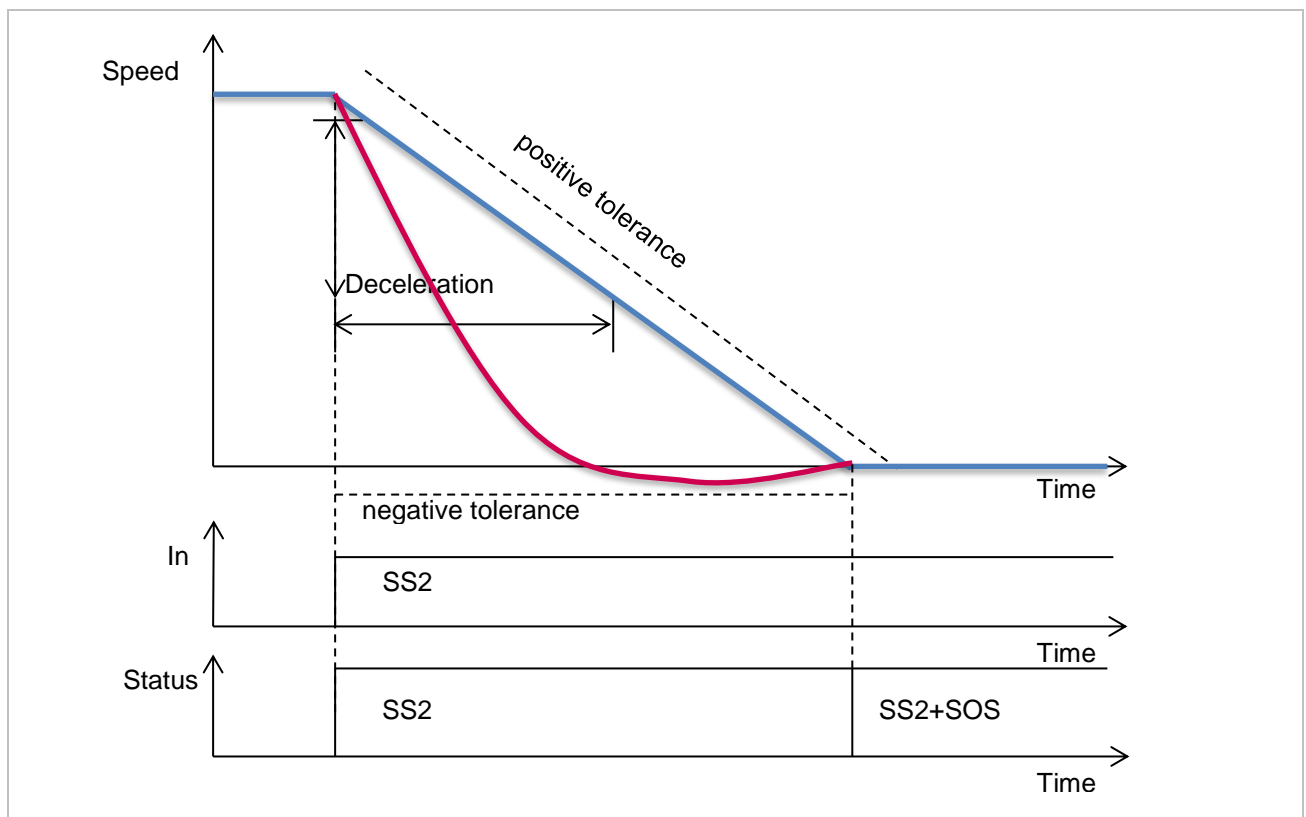

Figure 52: SS2-r safety function with higher deceleration permissible

The brake ramp is monitored after triggering of the function, as in the SS1-r function. After reaching standstill the function SOS (Safe Operating Stop) is executed.

Parameterization

- **Deceleration:**
Permits the configuration of the ramp which decelerates the motor of the COMBI-VERT.
- **Time window for speed deviation:**
- Permits a deviation of the motor from the ramp for the adjusted time. The STO safety function is executed if the time is exceeded. A status change to FailSafe is only triggered if the time from activation SS1-r to the violation of the ramp (incl. tolerance) plus the set tolerance time is less than the delay time specified by the setpoint ramp and the output speed. If the time of activation SS1-r plus tolerance time is higher, SS1-r will detect a successful deceleration and STO is set after the deceleration time has elapsed (related to ramp and output speed) and FS is not set.
The counter is incremented when the speed is outside the speed limit. The counter is decremented when the speed is back within the speed limit.
- **Negative and positive tolerance:**
Allows to define a range, in which speed deviations are tolerated by the ramp.
- **Selection of the function type:**

The SS2-r and SS2-t function or only SS2-r can be activated here.

- **Higher deceleration allowed:**
The speed must not be higher than the deceleration + positive tolerance. However, the lower speed limit is 0 - negative tolerance. Thus the drive can also decelerate faster.

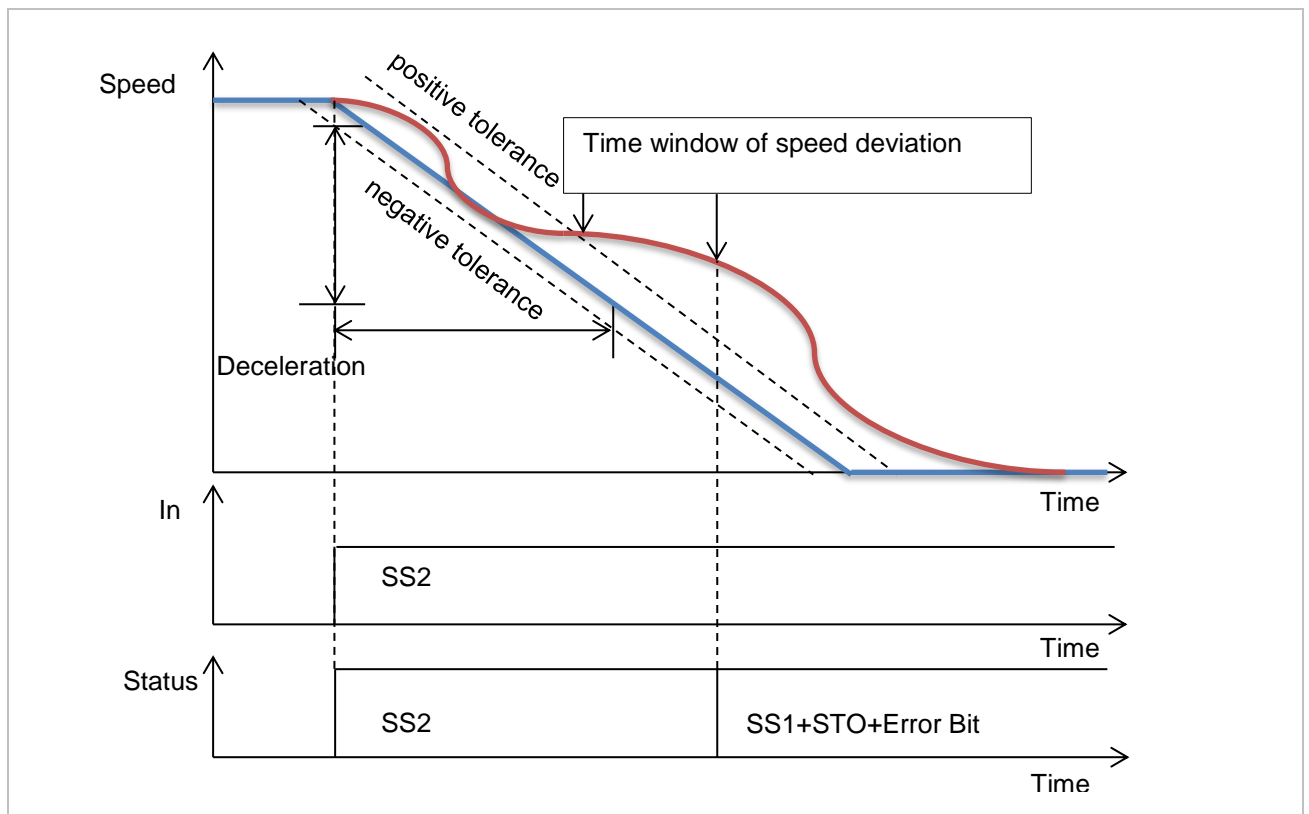

Figure 53: SS2-r safety function with faulty ramp

If the tolerance range is left longer than the defined time in the time window, it is changed into state STO.



- From control card firmware 2.5, a stop condition can be set for SS1 and SS2 in pn80. This means that when one of the conditions is triggered, the drive automatically moves down at the ramp.

11.6.5 Description of the SS2-t function

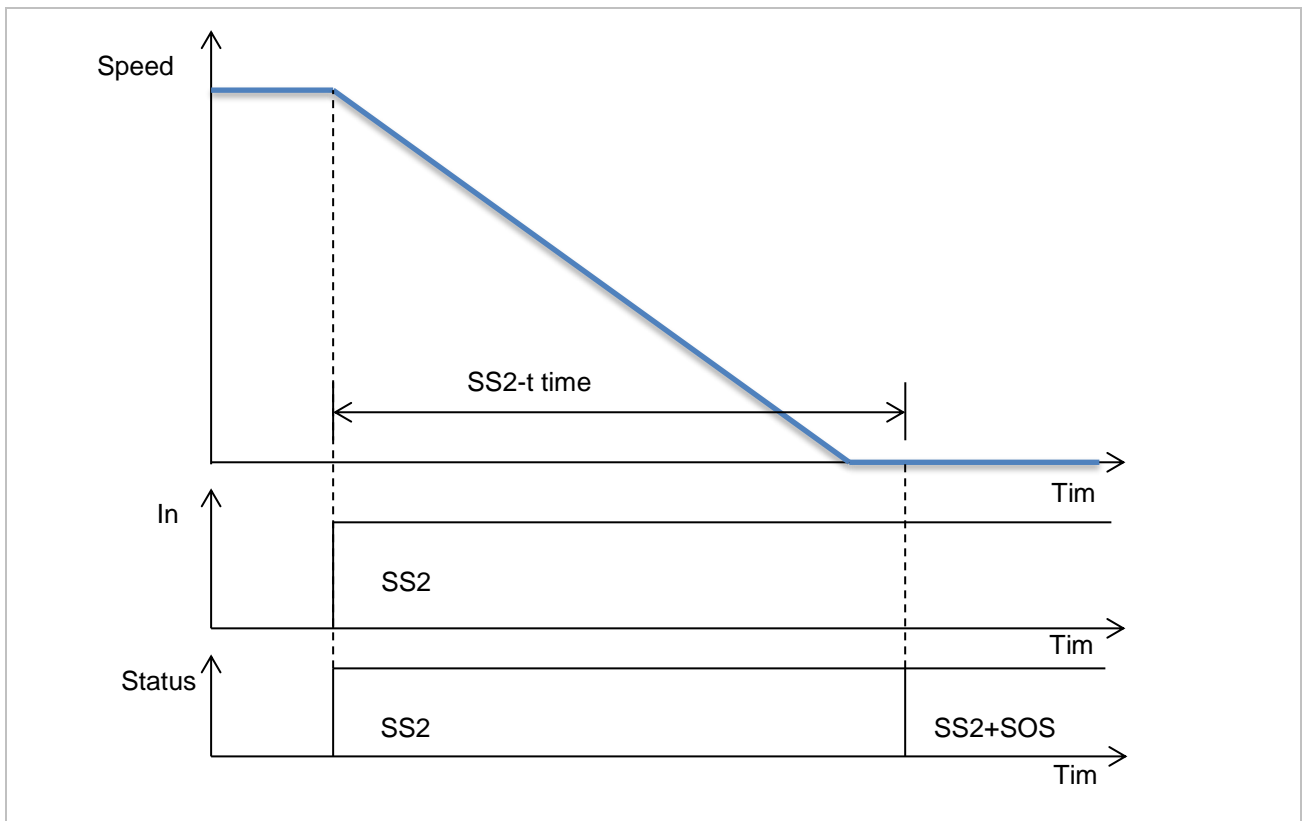

Figure 54: SS2-t function

After tripping of function SS1, the drive is decelerated due to the effect of the drive control. State SOS is assumed after expiration of the configurable "SS2-t time".

Parameterization

- **SS2-t time:**
If the entered time period has expired, the safety function SOS is executed. A ramp is not monitored here.
- **Selection of the function type:**
The SS2-r and SS2-t function or only SS2-t can be activated here.

11.7 Functional description Safe Operating Stop (SOS)

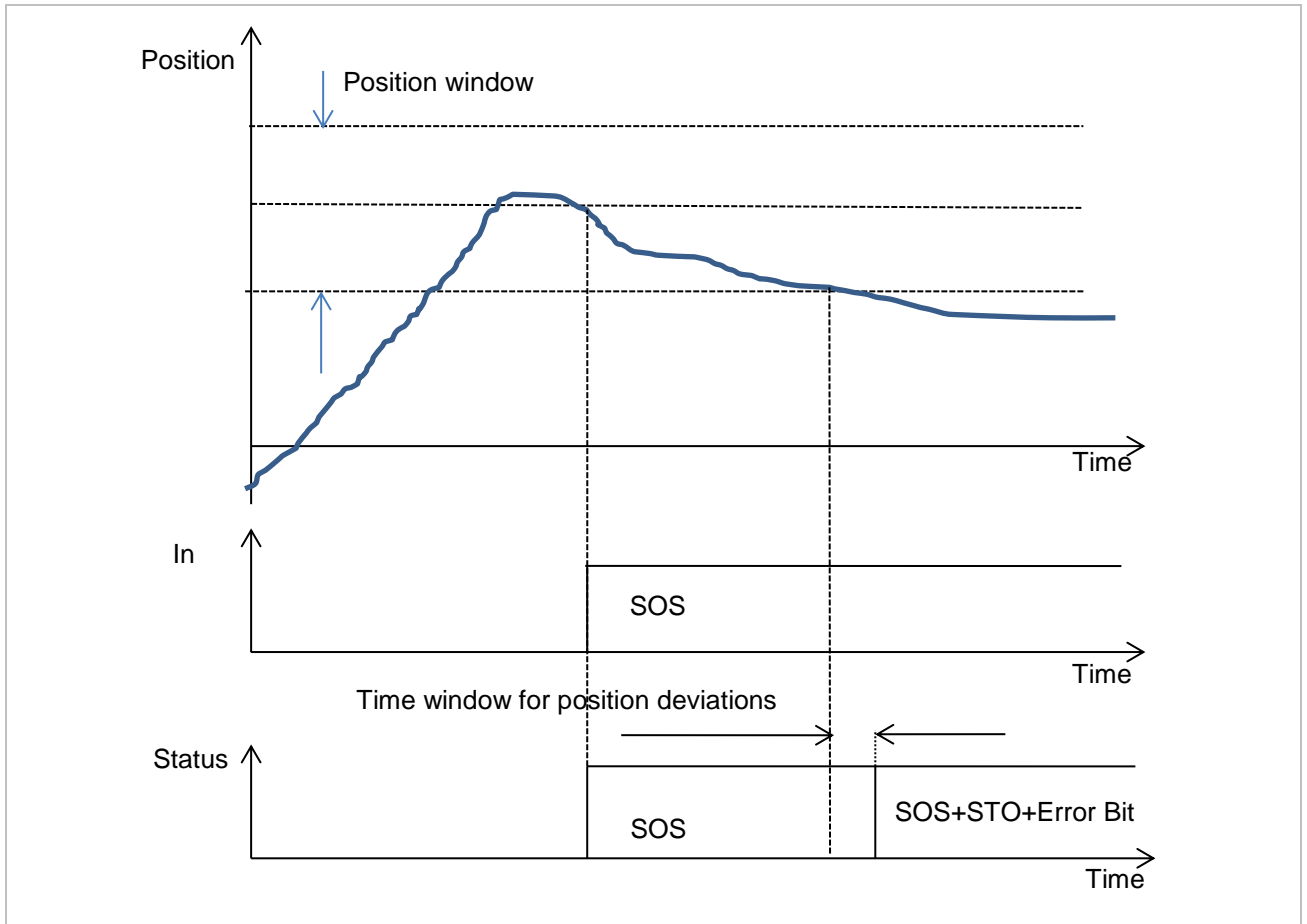

Figure 55: SOS safety function

The SOS function monitors whether the drive remains in its standstill position and rejects external torques. Since analog sensor signals are processed for position detection and no static sensor signals are present even at absolute standstill, it is necessary to define a tolerance window by a parameter.

Errors are faded out via a further parameter, which defines a max. tolerable time for short-term deviations of the tolerance window.

11.7.1 Activation of the safety function SOS

The circuit operates on two channels. The safety function of the control of the COMBI-VERT can only be left, if both hardware inputs are voltage supplied or if a corresponding status change has been received via a safe bus system. The SOS status is displayed in parameter SOS status in status bit 5.

11.7.2 Configuration parameters of the safety function SOS

Parameter	Wert	Einheit
SOS: Sicherer Betriebshalt		
Positionsfenster	0	BpU
Zeitfenster für Positionsabweichungen	0.000000	s

Figure 56: Configuration parameters for the safety function SOS

Parameterization

- **Position window:**
The drive shall not leave this position window.
- **Time window for position deviations**
If the position window is left longer than the time window for position deviations, then the safety function STO is executed. The counter is incremented when the speed is outside the speed limit. The counter is decremented when the speed is back within the speed limit.

11.7.3 Error response time SOS function

Technical data of the SOS function	
Maximum switch-on delay (+ filter time for the safety input + pulse length for the input analysis)	< 2 ms
Maximum switch-off delay (+ filter time for the safety input + pulse length for the input analysis)	< 2 ms

11.8 Functional description Safely-Limited Speed (SLS)

The SLS safety function ensures that the drive does not exceed the upper speed limit and does not fall below the lower speed limit.

Errors are faded out via a further parameter, which defines a max. tolerable time for short-term deviations of the tolerance window.

An adjustable error function is triggered in error case.

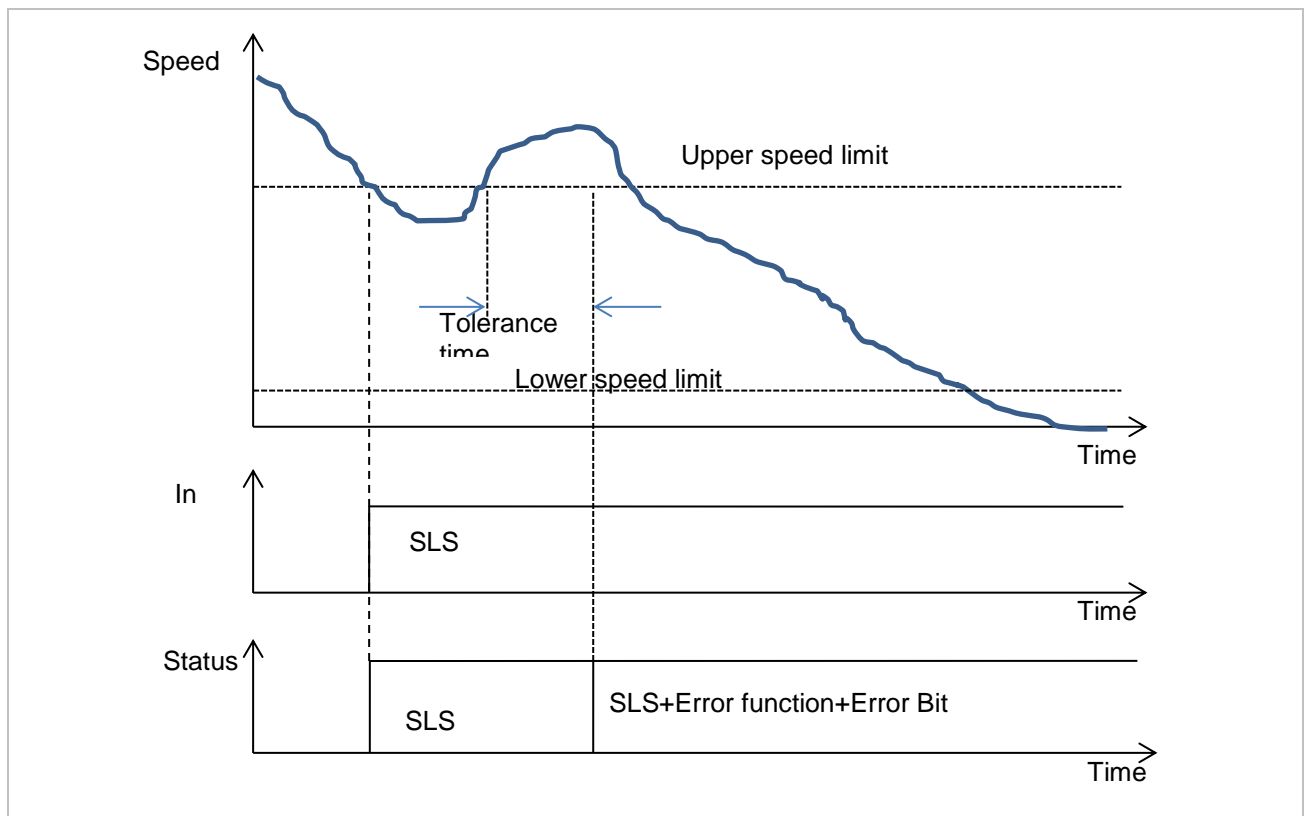

Figure 57: Safely limited speed - SLS

11.8.1 Activation of the safety function SLS

The circuit operates on two channels. The safety function of the control of the COMBI-VERT can only be left, if both hardware inputs are voltage supplied or if a corresponding status change has been received via a safe bus system. The SLS status is displayed in status bit 9 (=> 11.2).

11.8.2 Configuration parameters of the safety function SLS

Parameter	Value	Unit
SLS: Safely-limited speed		
speed limit	0.000000	1/min
Tolerance time	0.000000	s
Error function	STO	

Figure 58: Configuration parameters for the safety function SLS

Parameterization

- **Upper speed limit:**
The maximum permitted speed.
- **Lower speed limit:**
The minimum permitted speed.
- **Tolerance time:**
This is the time within the upper or lower speed limit shall be exceeded. The counter is incremented when the speed is outside the speed limit. The counter is decremented when the speed is back within the speed limit.
- **Error function:**
When exceeding the adjusted maximum speed by the tolerance time, this error function is executed. STO or SS1.

11.8.3 Error response times SLS function

Technical data of the SLS function	
Maximum switch-on delay (+ filter time for the safety input + pulse length for the input analysis)	< 2 ms
Maximum switch-off delay (+ filter time for the safety input + pulse length for the input analysis)	< 2 ms

11.9 Functional description SLP: Reference position

The function SLP reference position sets the reference position for the safety function "Safely-Limited Position (SLP)". Approach to reference point must be executed again after re-configuration of the safety module.

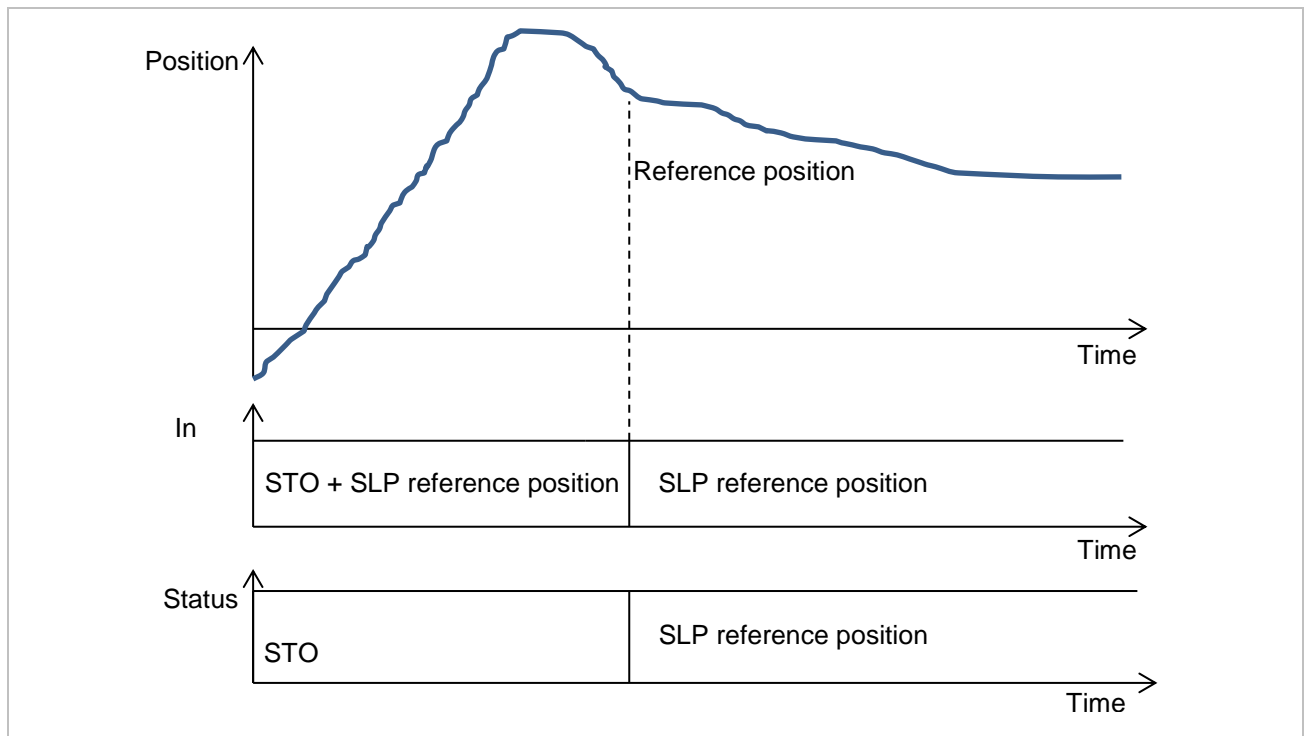

Figure 59: SLP Reference position

11.9.1 Activation of the function SLP reference position

1. A reference position must be set previously, in order that the safety function "Safely-Limited Position (SLP)" can be executed. The following must be observed.
 - a. The reference position can only be set if no safety function with higher priority is active => 11.1. If STO is activated via the inputs, no reference position can be set.
 - b. The reference position can be set only once.
 - c. The reference position is set exactly when the configured inputs are not supplied or the request was given via a safe bus system.
2. If the reference position has been set, bit SLP Set Reference Position (=>11.2) is set permanently in the status of the safety module.
3. If an output was configured for the function SLP: reference position, this output is switched permanently after the reference position has been set.

If the SLP reference position is set, this is displayed in parameter SLP reference position set status in status bit 12.

11.9.2 Configuration parameter SLP reference position

SLP: Reference position		
Absolute reference position	0	Bpr

Figure 60: Configuration parameter of the function SLP reference position

Parameterization

- Absolute reference position:**
 This is the reference position, which determines the maximum and minimum drive position. When interconnecting a push-button must be reserved for SLP reference position and another for SLP. The safety function SLP can only be executed if the reference position was previously set via push-button.

11.10 Functional description safely limited position (SLP)

- The safety function SLP ensures that the drive shaft does not exceed the parameterized absolute position limits.
- The maximum, limited range of the drive is defined with parameters "max. position limit" and "min. position limit".
- The detection of the reference position occurs (e.g.) via a position switch, which assigns a safe input of the safety module. During the detection of the position switch by the input of the safety module the absolute value of the reference position is stored as actual absolute position. The position limits are monitored based on encoder increments on two channels.

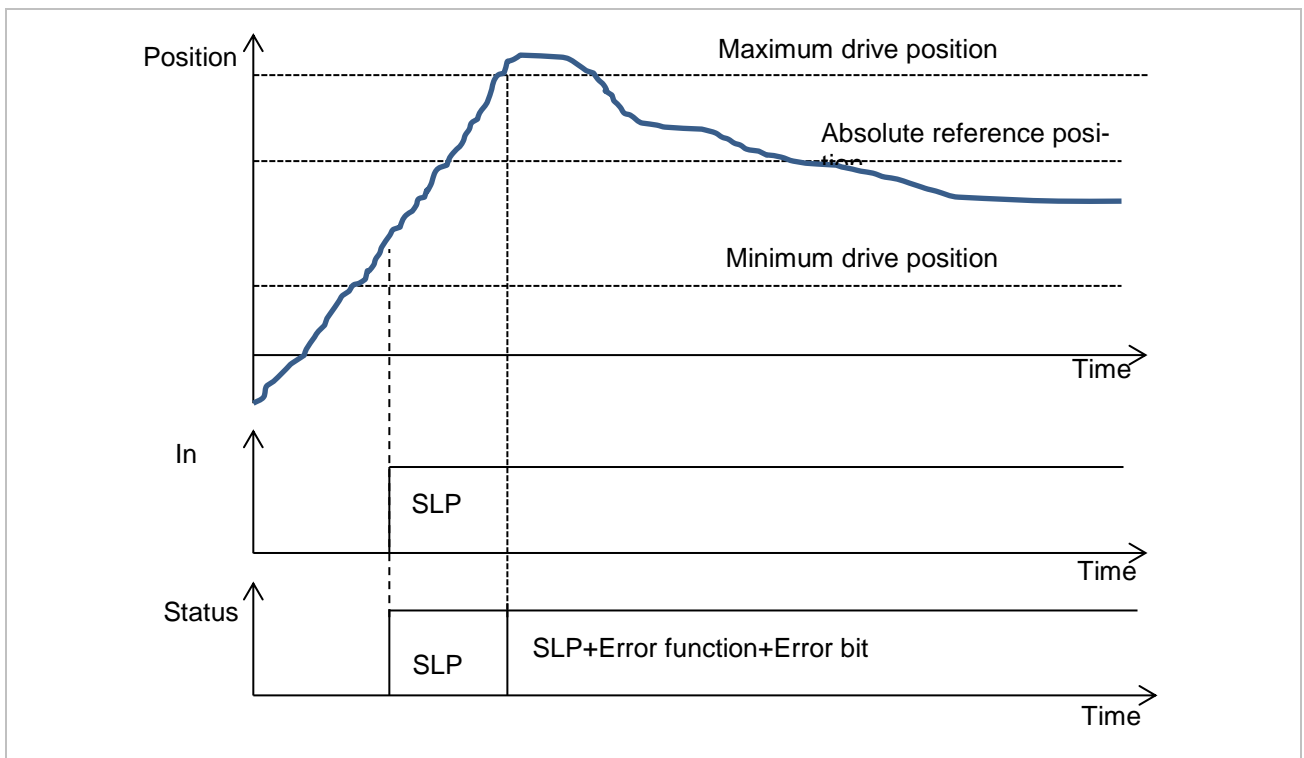

Figure 61: Safely-Limited Position – SLP)

11.10.1 Functional description Safe Emergency Limits (SEL)

The safety function SEL (Safe Emergency Limits) can be activated additionally to SLP. SEL is activated as soon as the SEL difference position is set to a value higher than 0.

From the difference position, the speed may no longer exceed the set SEL limit for the speed. The permissible speed decreases squarely close to the SLP maximum or minimum position. The following formula is valid:

$$\text{Speed limit} = \text{SEL Limit} * \sqrt{\left(\frac{\text{position difference}}{\text{SEL difference position}}\right)}$$

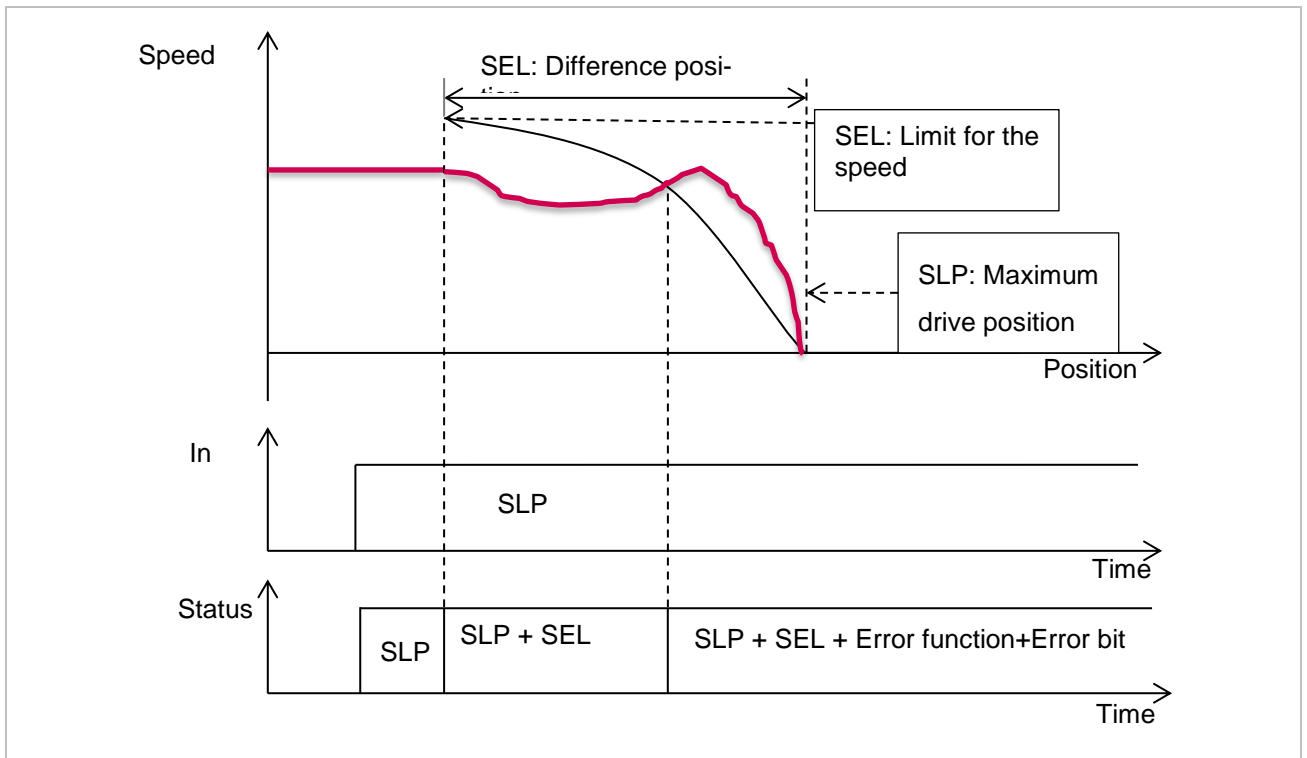

Figure 62: Safe Emergency Limits (SEL)

11.10.2 Activation of the safety function SLP

The circuit operates on two channels. Then the control in COMBIVERT can only left the safety function if both inputs are voltage supplied (function1 or function2 inputs see chapter 4). If both inputs are not set, the following is displayed in the state:

- the SLP status is displayed in status bit 12.
- the SEL status is displayed in status bit 13.

11.10.3 Configuration parameters of the safety function SLP

Parameter	Value	Unit
SLP: Safely-limited position [1]		
Maximum drive position	0	Ps
Minimum drive position	0	Ps
Error function	STO	
SEL: Difference position	0	Ps
SEL: Speed limit	0.000000	1/min

Figure 63: Configuration parameters for the safety function SLP

Parameterization

- Absolute reference position:**
 This is the reference position, which determines the maximum and minimum drive position. When interconnecting a push-button must be reserved for SLP reference position and another for SLP. The safety function SLP can only be executed if the reference position was previously set via push-button.
- Maximum drive position:**
 The motor must never exceed this maximum possible drive position. The adjustment is depending on the absolute reference position.
- Minimum drive position:**
 The motor must never fall below this minimum possible drive position. The adjustment is depending on the absolute reference position.
- Error function:**
 This error function is triggered on exceeding the adjusted maximum or minimum drive position. STO or SS1.
- SEL: Difference position:**
 The safety function SEL is activated as soon as the difference position to the max. or min. position has been reached. If this safety function is activated, then the speed of the drive may not exceed the set SEL limit for the speed.
- SEL: Limit for the speed:**
 If the safety function SEL is activated, the speed of the drive must not be increased beyond the limit. This is a ramp up to SLP maximum drive position.

11.10.4 Error response times SLP function

Technical data of the SLP function	
Maximum switch-on delay (+ filter time for the safety input + pulse length for the input analysis)	< 2 ms
Maximum switch-off delay (+ filter time for the safety input + pulse length for the input analysis)	< 2 ms

11.11 Functional description Safely-Limited Increment (SLI)

The safety function prevents that the drive shaft exceeds the defined limited position increments. The activation of an input configured with the function SLI of the safety module causes first the stop of the drive in the SOS function.

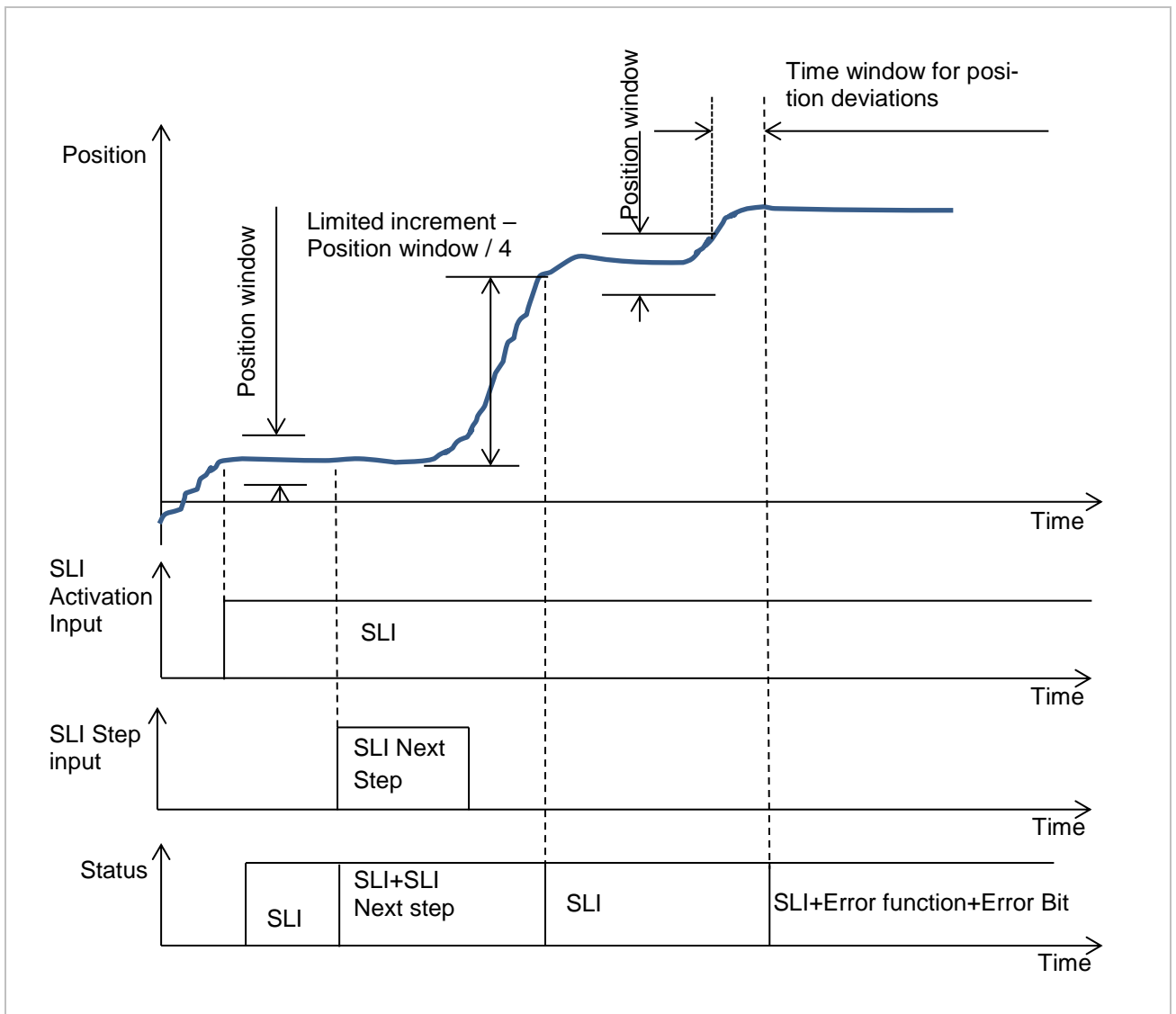

Figure 64: Safely-Limited Increment – SLI

Upon leaving the position windows, an error function is activated which triggers the function STO or SS1.

SLI Next Step can only be used if SLI has been previously activated.

11.11.1 Activation of the safety function SLI

The circuit operates on two channels. The safety function of the control of the COMBI-VERT can only be left, if both hardware inputs are voltage supplied or if a corresponding status change has been received via a safe bus system. The SLI status is displayed in state as follows:

- SLI status is displayed in status bit 14.
- SLI Next Step activation status is displayed in status bit 15.

11.11.2 Configuration of the SLI function

SLI: Safely-limited increment		
Limited increment	0	Bpr
Minimum length of stay in the position window	0.000000	s
Error function	STO	
Position window	0	Bpr
Time window for position difference	0.000000	s

Figure 65: Configuration parameters for the safety function SLI

Parameterization

- **Limited increment:**
As soon as the next step was activated, the safety module waits until the step was executed. This is the case, if the new position has reached the limited increment - (position window / 4) with positive direction of rotation. With negative direction, the next position is reached when the limited (-increment) + (position window / 4) is reached.
- **Minimum retention time in SOS:**
This is the minimum retention time in the safety function SOS after a step was executed.
- **Error function:**
In error case STO or SS1 is executed.
- **Position window:**
The position window, where the position can move, if no step is executed.
- **Time window for position deviation:**
The position may differ from the position window for a short time. The error function is triggered if the position deviation is longer than this time window. The counter is incremented when the speed is outside the speed limit. The counter is decremented when the speed is back within the speed limit.

11.11.3 Error response times SLI function

Technical data of the SLI function	
Maximum switch-on delay (+ filter time for the safety input + pulse length for the input analysis)	< 2 ms
Maximum switch-off delay (+ filter time for the safety input + pulse length for the input analysis)	< 2 ms

11.12 Functional description Safe Direction (SDI)

The safety function SDI ensures that the drive shaft maintains the direction of rotation selected by the input.

If the defined direction of rotation of the drive is not met, an error function is activated which triggers the function STO or SS1.

11.12.1 Activation of the safety function SDI

The circuit operates on two channels. The safety function of the control of the COMBI-VERT can only be left, if both hardware inputs are voltage supplied or if a corresponding status change has been received via a safe bus system. The SDI status is displayed in the status as follows:

- SDI forward is displayed in the status in status bit 6.
 - Positive speeds do not trigger the safety function.
- SDI reverse is displayed in the status in status bit 7.
 - Negative speeds do not trigger the safety function.

11.12.2 Configuration of the SDI function

Parameter	Wert	Einheit
SDI: Safe direction		
Safe direction of rotation	Forward	
Error function	STO	
Position window at standstill	0	Ps
Time window of the direction of rotation	0.000000	s

Figure 66: Configuration parameters for the safety function SDI

Parameterization

- **Error function:**
The error function is executed if the wrong direction of rotation was detected. STO or SS1 can be adjusted.
- **Position window at motor standstill:**
The position can vary slightly in standstill. By way an incorrect direction of rotation can be detected. This parameter allows the adjustment of a position difference at motor standstill.
- **Time window of the direction of rotation:**
Here you can adjust a time period within the motor may deviate from the safe direction of rotation.

11.12.3 Error response times SDI function

Technical data of the SDI function	
Maximum switch-on delay (+ filter time for the safety input + pulse length for the input analysis)	< 2 ms
Maximum switch-off delay (+ filter time for the safety input + pulse length for the input analysis)	< 2 ms

11.13 Functional description Safe Speed Monitor (SSM)

The safety function provides a safe output signal if the speed does not exceed a defined value. The safe output is switched off if the value of the parameterized speed plus hysteresis is exceeded. The safe output is only set if the value falls below the parameterized speed plus hysteresis.

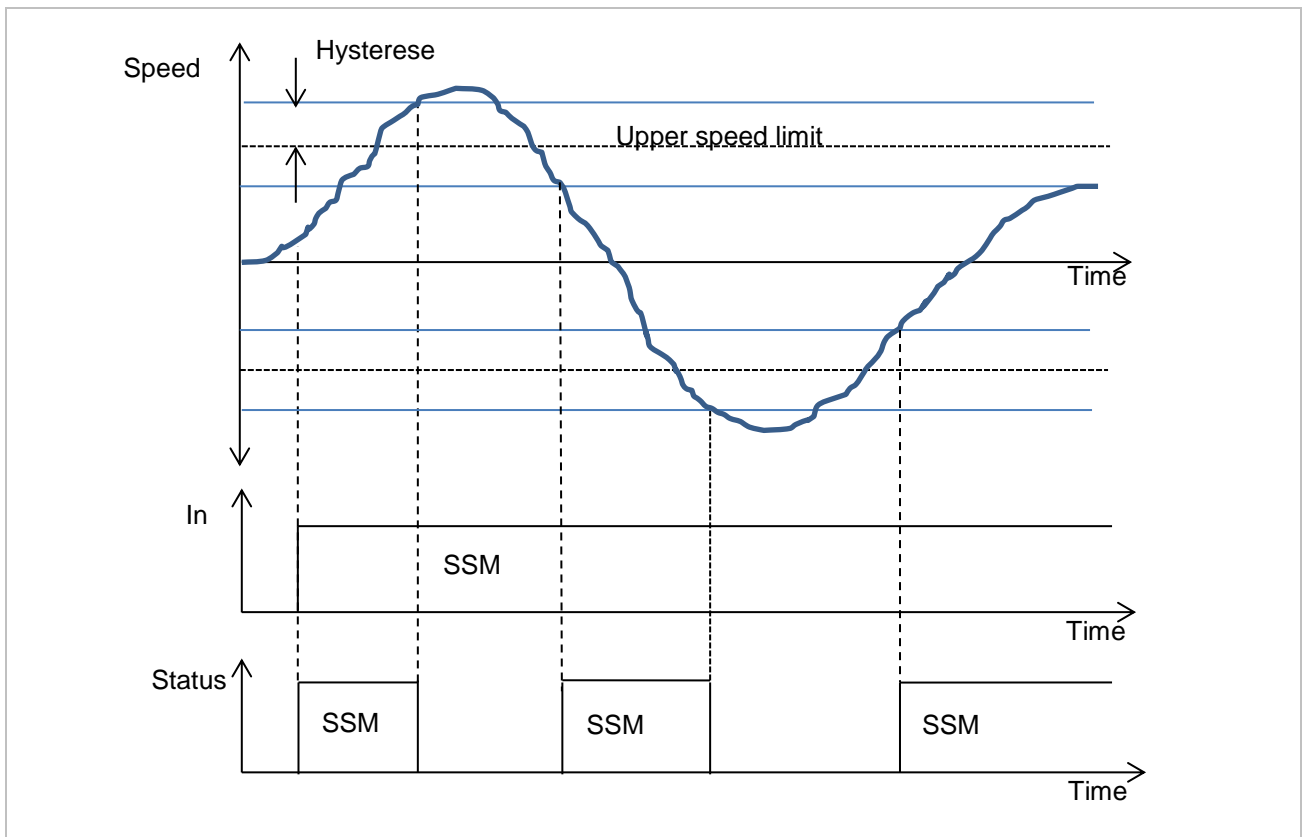

Figure 67: Safe Speed Monitor – SSM)

11.13.1 Activation of the safety function SSM

The circuit operates on two channels. The safety function of the control of the COMBI-VERT can only be left, if both hardware inputs are voltage supplied or if a corresponding status change has been received via a safe bus system. The SSM status is displayed in status bit 16.

11.13.2 Configuration of the SSM function

Parameter	Value	Unit
SSM: Safe speed monitor		
Speed level	0.000000	1/min
Hysteresis	0.000000	1/min
Monitoring always active	off	

Figure 68: Configuration parameters for the safety function SSM

Parameterization

- Upper speed limit:**
 Upper speed level when the SSM status shall be set.
- Lower speed limit:**
 Lower speed level when the SSM status shall be set.
- Hysteresis:**
 The SSM status is reset on exceeding the hysteresis + speed level. The SSM status is set again if the speed limit – hysteresis is fallen below.
- Monitoring always active:**
 The speed level can be monitored even without the configuration of an input for the function SSM.

11.13.3 Error response times SSM function

Technical data of the SSM function	
Maximum switch-on delay (+ filter time for the safety input + pulse length for the input analysis)	< 2 ms
Maximum switch-off delay (+ filter time for the safety input + pulse length for the input analysis)	< 2 ms

11.14 Functional description safe maximum speed (SMS)

The safety function SMS ensures that the drive does not exceed the upper speed limit and does not fall below the lower speed limit.

Errors are faded out via a further parameter, which defines a max. tolerable time for short-term deviations of the tolerance window.

An adjustable error function is triggered in error case.

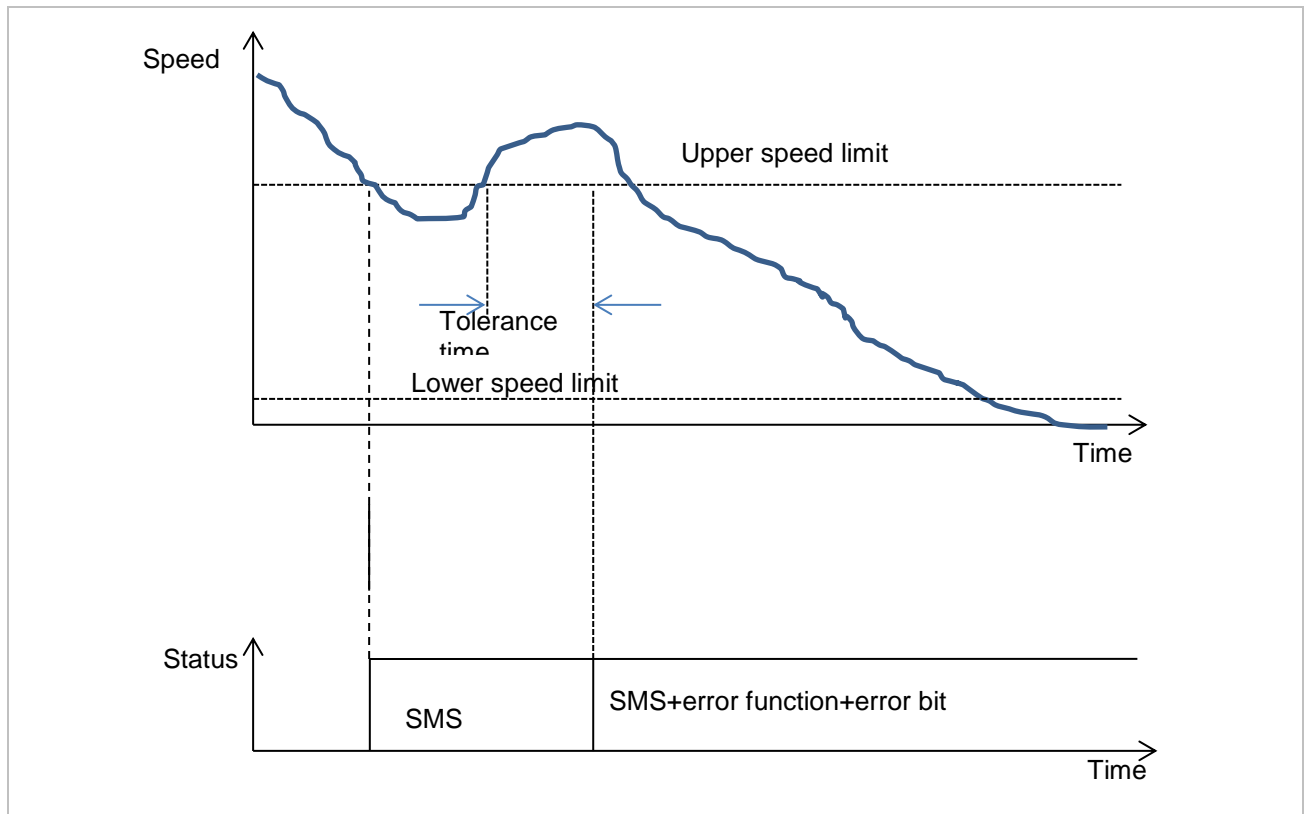

Figure 69: Safe Maximum Speed - SMS

11.14.1 Activation of the safety function SMS

SMS is always activated. If the speed limits are set that they correspond to the maximum permissible speed of the safety module, SMS is effectively switched off. The SMS status is displayed in parameter SMS status in status bit 17.

11.14.2 Configuration parameters of the safety function SMS

Parameter	Value	Unit
SMS: Safe maximum speed [1]		
Upper speed limit	60000.000000	1/min
Lower speed limit	-60000.000000	1/min
Tolerance time	0.000000	s
Error function	STO	

Figure 70: Configuration parameters for the safety function SMS

Parameterization

- Upper speed limit:**
 The maximum permitted speed.
- Lower speed limit:**
 The minimum permitted speed.
- Tolerance time:**
 Time within the maximum or minimum speed shall be exceeded. The counter is incremented when the speed is outside the speed limit. The counter is decremented when the speed is back within the speed limit.
- Error function:**
 When exceeding the adjusted maximum speed by the tolerance time, this error function is executed. STO or SS1.

11.14.3 Error response times SMS function

Technical data of the SMS function	
Maximum switch-off delay	< 2 ms

11.15 Functional description Safe Limited Acceleration (SLA)

The SLA safety function ensures that the drive does not exceed a maximum speed. This applies both to the positive and negative direction of rotation.

An adjustable malfunction is executed in error case.

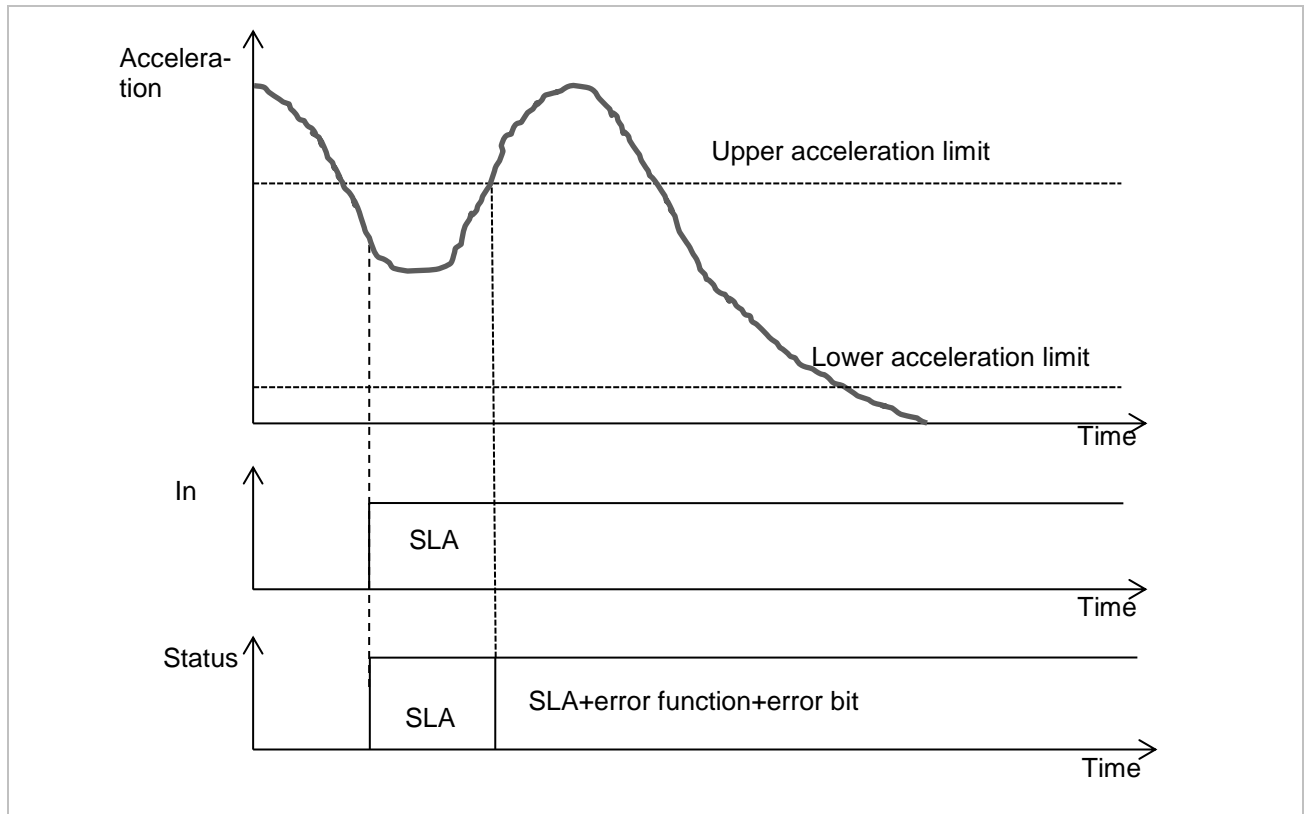

Figure 71: Safe maximum acceleration - SLA

11.15.1 Acceleration limits

The upper and lower acceleration limits have a dependence on the speed scan time and speed PT1 time. The parameters described in chapter 10.5 are also valid for the SLA function.

The SLA safety function checks the acceleration in a 250 µs grid. The following formula is valid:

$$\text{Limit} / 4000 * 60 > V2 - V1.$$

V2-V1 are calculated by the safety module in a 250 µs grid in rpm.

Example:

With an upper acceleration limit of 2000 1/s², the differential speed must not exceed 30 rpm per 250 µs grid. Calculation: (Limit / 4000) * 60 > V2 - V1.

Procedure for triggering the error function:

Speed fluctuations are much more problematic at SLA than with other safety functions, since the difference of the speed between two scanning steps (250µs) is always examined. A high PT1 filter time can improve the behavior (e.g. 100ms). But attention, a high PT1 filter time has adverse effects on the behavior of other speed-sensitive safety functions. These trigger later, or they do not recognize very briefly overspeed.

The log can be evaluated to detect the acceleration from the safety module.

Position	Speed	Time slots per 62.5 µs	Details
261856	253.5122 1/min	13647	66179: STO + Brake closed + Fail safe + SLA + SMS
-2147483648	252.7471 1/min	13643	513: STO + Brake open + SLA + SMS

Figure 72 Log entries for the SLA safety function

As soon as acceleration above the set limits is detected, 2 log entries are generated. The top log entry shows the triggering of SLA with the fail safe bit and the next log entry 250µs before the error was detected.

The acceleration can be calculated with this formula:

$$(\text{Speed 1} - \text{Speed 2}) / 60\text{s} / 250\mu\text{s} = \text{acceleration}$$

In this example that means:

$$(253.5122 \text{ rpm} - 252.7471 \text{ rpm}) / 60\text{s} / 0.00025\text{s} = 51 \text{ 1/s}^2. \text{ The adjusted upper acceleration limit was } 50 \text{ 1/s}^2.$$

The position at time Speed2 is not stored. Therefore this position is always indicated with -2147483648.

11.15.2 Activation of the safety function SLA

The circuit operates on two channels. The safety function of the control of the COMBI-VERT can only be left, if both hardware inputs are voltage supplied or if a corresponding status change has been received via a safe bus system. The SLA status is displayed in status bit 10.

11.15.3 Configuration parameter of the safety function SLA

Parameter	Value	Unit
SLA: Safely-limited acceleration [1]		
Upper acceleration limit	0.000000	1/s ²
Lower acceleration limit	0.000000	1/s ²
Error function	STO	

Figure 73: Configuration parameters for the safety function SLA

Parameterization

- **Upper acceleration limit:**
The maximum permitted acceleration.
- **Lower acceleration limit**
The minimum permitted acceleration.
- **Error function:**
This error function is carried out if the upper acceleration limit is exceeded, or if the lower acceleration limit is fallen below. STO or SS1.

11.15.4 Error response times SLA function

Technical data of the SLA function	
Maximum switch-on delay (+ filter time for the safety input + pulse length for the input analysis)	< 2 ms
Maximum switch-off delay (+ filter time for the safety input + pulse length for the input analysis)	< 2 ms

12 Safety over EtherCAT® (FSoE)

12.1 Setting the fieldbus address

In addition to the safety module address, there is also the fieldbus address. This address can be set on the status page of COMBIVIS.

The fieldbus address should always be set before the download of the configuration data because, the safety module changes into error state with the change of the fieldbus address. The error state is only left when a configuration with the same fieldbus address is downloaded.

12.2 FSoE bus settings

Fieldbus parameter	
Safety address	0

Figure 74: Safety module address in the configuration

Parameterization

- Bus type:**
 This is the selection of the safe bus type. The selection parameters are „No bus“ or „FSoE“. Without bus means that no safe bus system is used and the safety module is controlled only via the inputs. FSoE means, that the bus system Safety over Ethercat® is used.
- Safety module address:**
 The safety module address must agree with the fieldbus address, which is set in the safety module. As standard, this address is set to value 0.
- Safe bus data length:**
 If a safe bus system has been selected, the length of the safe data can be adjusted here. This length must agree with the configuration in the safe control. In the case of FSoE, only the following settings are permissible: 6 byte, 7 byte, 11 byte or 15 byte.

12.3 FSoE functional description and parameterization

For this purpose, a separate document has been created which shows the functionality of FSoE in connection with the safety module type 3.

13 Wiring Examples

13.1 Example of a wiring of clock outputs with inputs

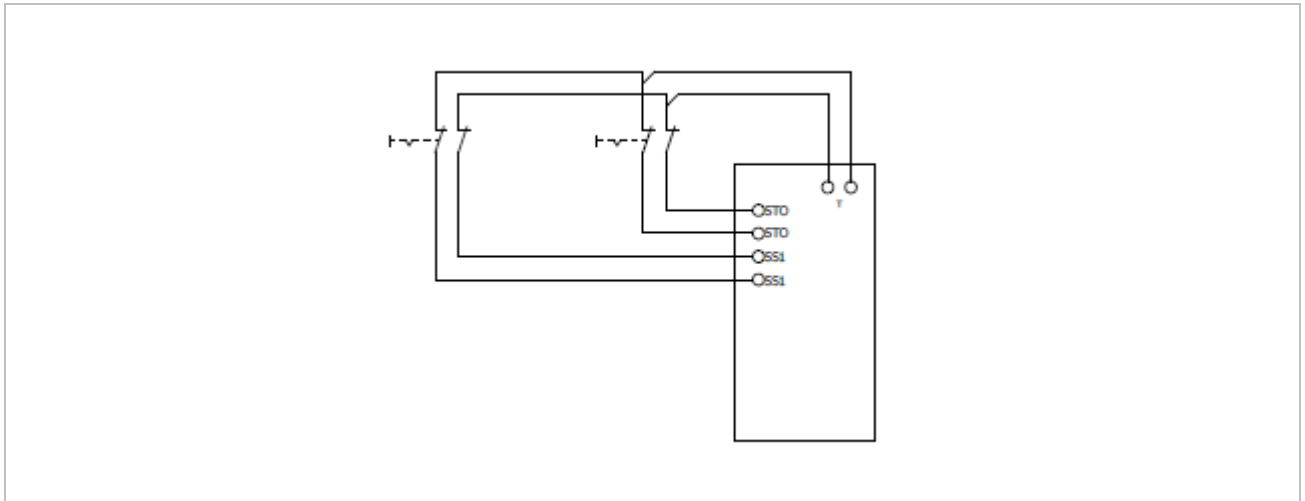

Figure 75: Clock outputs wired with inputs

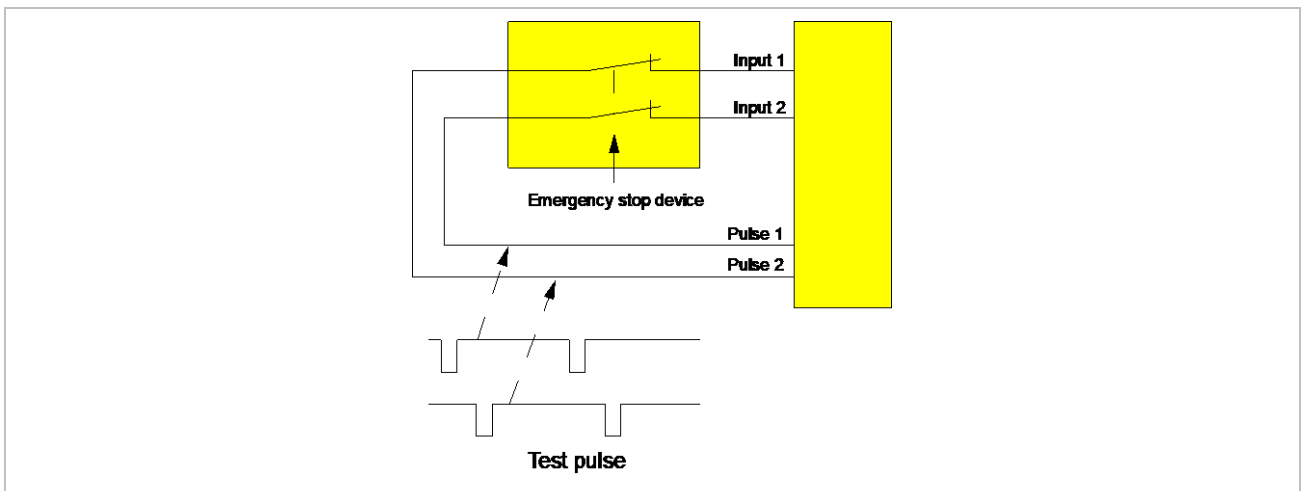

Figure 76: Test pulses of the clock outputs

Figure 75 displays an example of a wiring of the clock outputs with STO and SS1 input.

In order to detect dangerous external line short circuits between two related inputs and/or to voltage supply potentials, mechanical contact pairs are supplied via phase-shifted clock outputs. The module provides two clock signals.

NOTICE

Avoid line short circuits!

- Since external line short circuits to inputs with the same phase of the clock pulses can not be detected, wiring precautions shall be taken to avoid this error.

13.1.1 Parameterisation of the clock outputs and inputs

The parameterization of the clock signal inputs and outputs are displayed in Figure 77 and Figure 78.

Example of a wiring of clock outputs with inputs

Parameter	Value	Unit
Test signal input configuration		
Test signal period	7.000000	s
Test signal pulse length	0.001000	s
Check of the test-signal for the STO-Inputs	on	
Check of the test-signal for the SBC-Inputs	off	
Check of the test-signal for the Function1-Inputs	off	
Check of the test-signal for the Function2-Inputs	off	

Figure 77: Configuration of the clock signal inputs

Parameter	Value	Unit
Clock output configuration		
Period of the Clock-Output	7.000000	s
Pulse length of the Clock-Output	0.001000	s

Figure 78: Configuration of the clock outputs

13.2 Example of a ripple chain

13.2.1 Closed ripple chain with 2 safety modules start-up behaviour

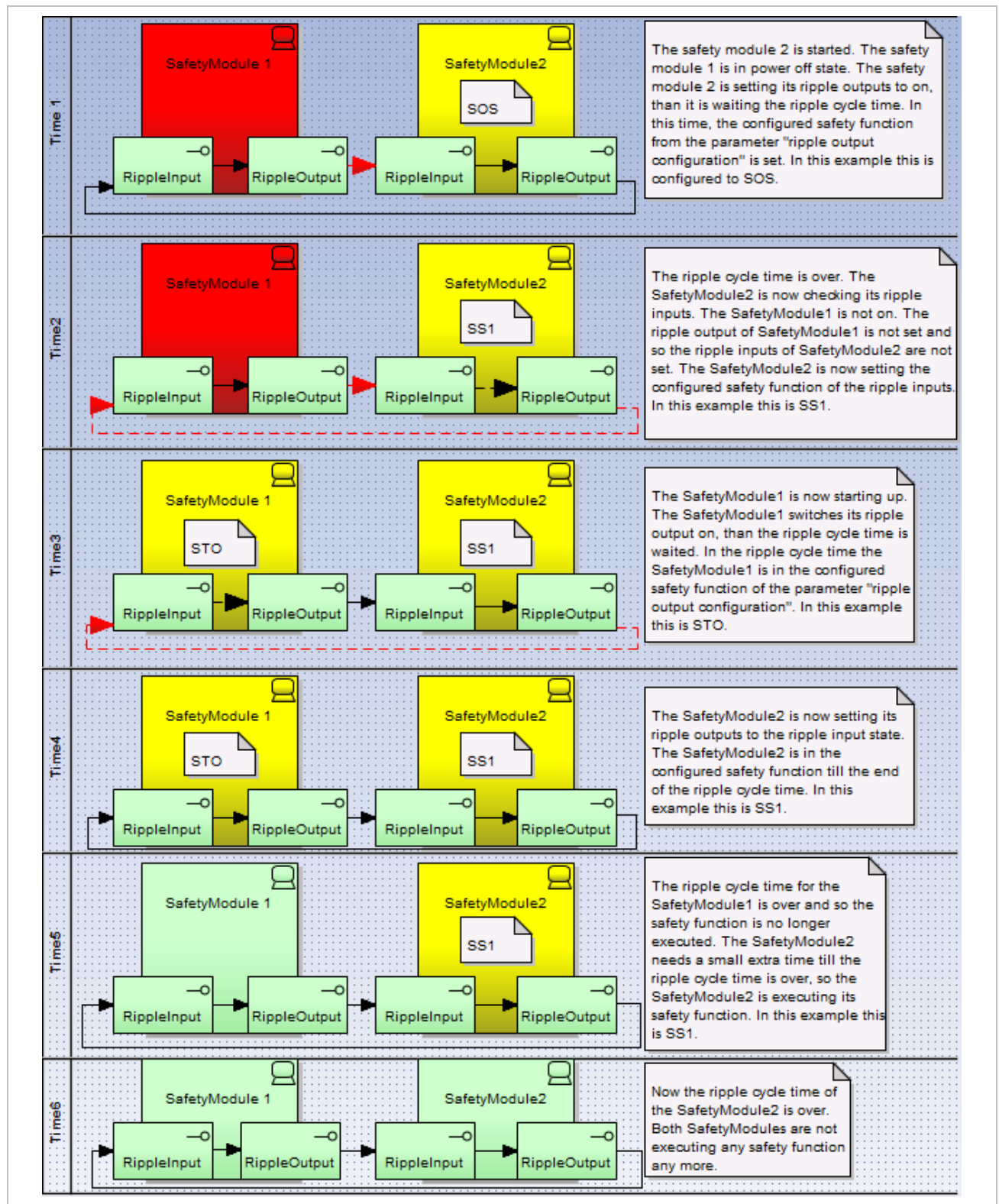

Figure 79: Closed ripple chain with 2 safety modules start-up behaviour

13.2.2 Closed ripple chain with 3 safety modules

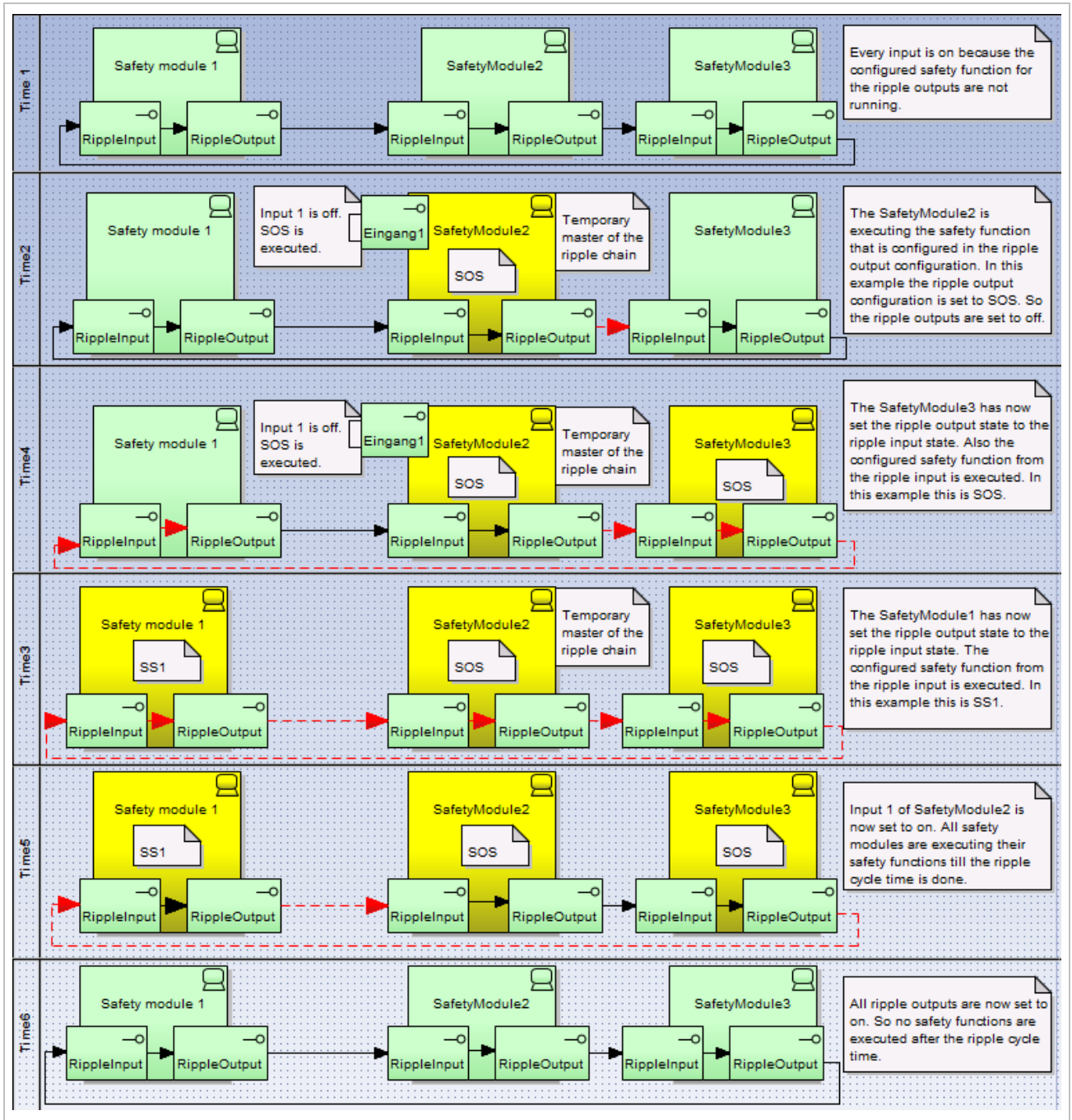

Figure 80: Ripple chain with 3 safety modules

13.3 Circuit example with STO, SS1 and SS2 and ripple chain

This is a circuit example for a ripple chain with six COMBIVERT.

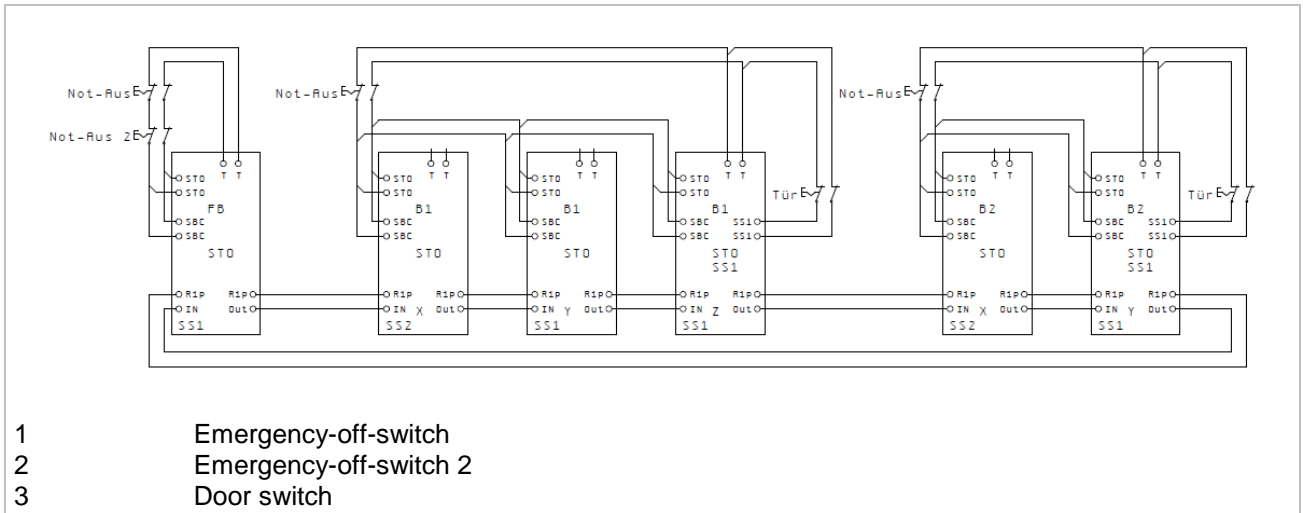

Figure 81: Circuit example with emergency stop, door, STO, SS1 and SS2

13.3.1 Parameterization for COMBIVERT FB

As seen in the first COMBIVERT FB in Figure 81, the ripple inputs must be configured as SS1 safety function. The error time for the input remains set to the standard value, see Figure 82.

- The ripple output configuration is adjusted as seen in Figure 83. The following applies:
 The ripple cycle time per COMBIVERT is 3.2ms (see chapter 9.2) (4ms is used here) * 6 COMBIVERT = 24ms. The ripple output configuration is set to STO and this COMBIVERT is not the ripple master. Attention, the filter time for the ripple inputs must be added here.
- Furthermore, the clock signal input configuration must be configured, see Figure 84. The evaluation of the clock signal for the STO and SBC input must be switched on here.
- Additionally to these two settings also the encoder must be configured and the SS1 safety function must be parameterized.

Parameter	Value	
Ripple input configuration		
Configuration of the Ripple-Inputs	SS1	
Tolerance time of the Ripple-Inputs	0.010000	s

Figure 82: Ripple input configuration for the COMBIVERT FB

Parameter	Value	Unit
Ripple output configuration		
Configuration of the Ripple-Output	1	
Ripple Master	off	
Cycle time	0.024000	s

Figure 83: Ripple output configuration for the COMBIVERT FB

Parameter	Value	Unit
Test signal input configuration		
Test signal period	10.000000	s
Test signal pulse length	0.001000	s
Check of the test-signal for the STO-Inputs	on	
Check of the test-signal for the SBC-Inputs	on	
Check of the test-signal for the Function1-Inputs	off	
Check of the test-signal for the Function2-Inputs	off	

Figure 84: Clock signal input configuration for the COMBIVERT FB

13.3.2 Parameterization for the COMBIVERT B1X

- The ripple input configuration is set to the safety function SS2 and the error time for the input remains set to the default value => Figure 85.
- The ripple output configuration corresponds to the configuration of the COMBIVERT FB, see Figure 73.
- The clock signal input configuration is set to the cycle time of 5 s, since this cycle duration is different to the COMBIVERT FB and wiring errors can be detected by the safety module => Figure 86. The evaluation of the clock signal is switched on for the STO and SBC input.
- Additionally to these two settings also the encoder must be configured and the SS1 safety function must be parameterized.

Parameter	Value	Unit
Ripple input configuration		
Configuration of the Ripple-Inputs	SS2	
Tolerance time of the Ripple-Inputs	0.010000	s

Figure 85: Ripple input configuration for the COMBIVERT B1X

Parameter	Value	Unit
Test signal input configuration		
Test signal period	5.000000	s
Test signal pulse length	0.001000	s
Check of the test-signal for the STO-Inputs	on	
Check of the test-signal for the SBC-Inputs	on	
Check of the test-signal for the Function1-Inputs	off	
Check of the test-signal for the Function2-Inputs	off	

Figure 86: Clock signal input configuration for the COMBIVERT B1X

13.3.3 Parameterization for the COMBIVERT B1Y

- The ripple inputs must be configured as SS1 safety function as seen in Figure 81 of the third COMBIVERT B1Y. The error time for the input remains set to the default value => Figure 82.
The ripple output configuration corresponds to the configuration of the COMBIVERT FB => Figure 83.
The clock signal input configuration corresponds to the configuration of the COMBIVERT B1X => Figure 86.
- Additionally to these two settings also the encoder must be configured and the SS1 safety function must be parameterized.

13.3.4 Parameterization for the COMBIVERT B1Z

- The ripple inputs must be configured as SS1 safety function as seen in Figure 81 of the fourth COMBIVERT B1Z. The error time for the input remains set to the default value => Figure 82.
- Valid for the ripple output configuration:
The ripple output must be reset at STO and SS1. Value 5 (STO value 1 + SS1 value 4) is adjusted for the ripple output configuration => Figure 87.
- The clock signal input configuration corresponds to the configuration of the COMBIVERT B1X, with one exception:
Also the evaluation of the clock signal is switched on for input1 => Figure 88.
- The clock output configuration is adjusted to a cycle time of 5s and a pulse length of 0.001s. This agrees then with the other two COMBIVERT wherefore the evaluation of the clock signal was adjusted. Parameterization => Figure 89.
- Input1 input configuration is set to configuration SS1 and the error time is left at the default value. The input status is equivalent, because both switches are switched simultaneously. Parameterization => Figure 90.
- Additionally to these two settings also the encoder must be configured and the SS1 safety function must be parameterized.

Parameter	Value	Unit
Ripple output configuration		
Configuration of the Ripple-Output	5	
Ripple Master	off	
Cycle time	0.024000	s

Figure 87: Ripple output configuration for the COMBIVERT B1Z

Parameter	Value	Unit
Test signal input configuration		
Test signal period	5.000000	s
Test signal pulse length	0.001000	s
Check of the test-signal for the STO-Inputs	on	
Check of the test-signal for the SBC-Inputs	on	
Check of the test-signal for the Function1-Inputs	on	
Check of the test-signal for the Function2-Inputs	off	

Figure 88: Clock signal input configuration for the COMBIVERT B1Z

Parameter	Value	Unit
Clock output configuration		
Period of the Clock-Output	5.000000	s
Pulse length of the Clock-Output	0.001000	s

Figure 89: Clock output configuration for the COMBIVERT B1Z

Parameter	Value	Unit
Function 1 input configuration		
Configuration of the Function1-Inputs	SS1	
Tolerance time of the Function1-Inputs	0.010000	s
Status of the Function1-Inputs	equivalent	

Figure 90: Input1 input configuration for the COMBIVERT B1Z

13.3.5 Parameterization for the COMBIVERT B2X

- The ripple input configuration is set to the safety function SS2 and the error time for the input remains set to the default value => Figure 85.
- The ripple output configuration corresponds to the configuration of the COMBIVERT FB => Figure 83.
- The clock signal input configuration is set to a cycle time of 7s, since this cycle duration is different to the COMBIVERT FB and B1 and wiring errors can be detected by the safety module => Figure 91. The evaluation of the clock signal is switched on for the STO and SBC input.
- Additionally to these two settings also the encoder must be configured and the SS1 safety function must be parameterized.

Parameter	Value	Unit
Test signal input configuration		
Test signal period	7.000000	s
Test signal pulse length	0.001000	s
Check of the test-signal for the STO-Inputs	on	
Check of the test-signal for the SBC-Inputs	on	
Check of the test-signal for the Function1-Inputs	off	
Check of the test-signal for the Function2-Inputs	off	

Figure 91: Clock signal input configuration for the COMBIVERT B2X

13.3.6 Parameterization for the COMBIVERT B2Y

- The ripple inputs must be configured as SS1 safety function as seen in Figure 81 of the sixth COMBIVERT B2Y. The error time for the input remains set to the default value => Figure 82.
- Valid for the ripple output configuration:
The ripple output must be reset at STO and SS1. Value 5 (STO value 1 + SS1 value 4) is adjusted for the ripple output configuration => Figure 85.
- The clock signal input configuration corresponds to the configuration of the COMBIVERT B1X, with one exception:
Also the evaluation of the clock signal is switched on for input1 => Figure 92.
- The clock output configuration is adjusted to a cycle time of 7s and a pulse length of 0.001s. This agrees then with the COMBIVERT B2X wherefore the evaluation of the clock signal was adjusted. Parameterization => Figure 89.
- Input1 input configuration is set to configuration SS1 and the error time is left at the default value. The input status is equivalent, because both switches are switched simultaneously. Parameterization => Figure 94.
- Additionally to these two settings also the encoder must be configured and the SS1 safety function must be parameterized.

Parameter	Value	Unit
Test signal input configuration		
Test signal period	7.000000	s
Test signal pulse length	0.001000	s
Check of the test-signal for the STO-Inputs	on	
Check of the test-signal for the SBC-Inputs	on	
Check of the test-signal for the Function1-Inputs	on	
Check of the test-signal for the Function2-Inputs	off	

Figure 92: Clock signal input configuration for the COMBIVERT B2Y

Parameter	Value	Unit
Clock output configuration		
Period of the Clock-Output	7.000000	s
Pulse length of the Clock-Output	0.001000	s

Figure 93: Clock output configuration for the COMBIVERT B2Y

Parameter	Value	Unit
Function 1 input configuration		
Configuration of the Function1-Inputs	SS1	
Tolerance time of the Function1-Inputs	0.010000	s
Status of the Function1-Inputs	equivalent	

Figure 94: Input1 input configuration for the COMBIVERT B2Y

14 Acceptance tests and configuration check

DIN EN 61800-5-2 section 7.1 point f) prescribes a configuration check of the safety functions in cases when the integrity of the configuration of a safety function can not be guaranteed.

COMBIVIS has an integrated configuration tool, which has the acceptance according to IEC 61800-5-2 and thus is suitable to display the configuration error-free and to transfer it to the safety module. Acceptance of the configuration is not necessary. Nevertheless, the configured safety functions must be checked and this must be noted in the acceptance test.

14.1 Sense of the acceptance tests

The acceptance test is used to validate the configured safety function with regard to the system behaviour. To this end the limits of the safety function are violated systematically and the error response is recorded. If the configuration is changed, then a new acceptance test must be carried out.

14.2 Inspector

One person must be determined as inspector, who is able to carry out the test due to their technical training and knowledge of the configured safety functions.

14.3 Protocol of the acceptance test

A protocol must be created during execution of the acceptance test.

NOTICE

Configuration changes!

- If configuration parameters are changed, the test must be repeated and the result must be recorded in the test report.

14.4 Execution of the acceptance test and scope of the audit

1. Documentation of the system and safety devices
 - a. Description of the system including overview screen
 - b. Document configured safety functions including parameter version and CRC.
2. Check functionality of the used safety functions (functional test)
 - a. STO: Check function "Safe Torque Off".
 - b. SBC: Check function "Safe Brake Control".
 - c. SS1: Check function "Safe Stop 1".
 - d. SS2: Check function "Safe Stop 2".
 - e. SOS: Check function "Safe Operating Stop".
 - f. SLS: Check function "Safely-Limited Speed".
 - g. SLP: Check function "Safely-Limited Position".
 - h. SLI: Check function "Safely-Limited Increment".
 - i. SDI: Check function "Safe Direction".
 - j. SSM: Check function "Safe Speed Monitor".
 - k. SLA: Check function "Safe Limited Acceleration".
3. Completion of the test report and record the test results
 - a. Document the functional test.
 - b. Note the name of the inspectors including signature.
 - c. Check the selected user in the safety module including the rights.
 - d. Insert the measurement reports and other notations of the test report.

15 Maintenance and modifications at the safety module

Repairs, hardware changes and firmware changes must be carried out only by KEB.

NOTICE

Manipulations!

- Through an engage into the device, e.g., soldering, replacement of components leads to the cancellation of the safety authorisation and the warranty by KEB.
-

An exchange of the safety module by the user is not possible. Please contact the support of KEB.

16 Annex to the declaration of conformity

The conformity was confirmed as follows:

EC Type-Examination Certificate



Reg.-Nr./No.: 01/205/5781.00/20

Prüfgegenstand Product tested	Sicherheitsmodule 2/3 für die COMBIVERT Antriebsserie Safety Modules 2/3 for the COMBIVERT drive series	Zertifikats- inhaber Certificate holder	KEB Automation KG Südstraße 38 32683 Barntrup Germany
Typbezeichnung Type designation	Details see attached "Revision List"		
Prüfgrundlagen Codes and standards	IEC 61800-5-2:2016 IEC 61800-5-1:2016 IEC 61800-3:2017 IEC 61508 Parts 1-7:2010		EN ISO 13849-1:2015 EN 62061:2005 + AC:2010 + A1:2013 + A2:2015 IEC 61131-2:2017 (in extracts)
Bestimmungsgemäße Verwendung Intended application	Die Module erfüllen die Anforderungen der Prüfgrundlagen (Kat. 4 / PL e nach EN ISO 13849-1, SIL 3 / SILCL 3 nach IEC 61800-5-2 / IEC 61508 / EN 62061) und können in Anwendungen bis PL e nach EN ISO 13849-1 und SIL 3 nach EN 62061 / IEC 61508 eingesetzt werden. The modules comply with the requirements of the relevant standards (Cat. 4 / PL e acc. to EN ISO 13849-1, SIL 3 / SILCL 3 acc. to IEC 61800-5-2 / IEC 61508 / EN 62061) and can be used in applications up to PL e acc. to EN ISO 13849-1 and SIL 3 acc. to EN 62061 / IEC 61508.		
Besondere Bedingungen Specific requirements	Die Hinweise in der zugehörigen Installations- und Betriebsanleitung sind zu beachten. The instructions of the associated Installation and Operating Manual shall be considered.		

Es wird bestätigt, dass der Prüfgegenstand mit den Anforderungen nach Anhang I der Richtlinie 2006/42/EG über Maschinen übereinstimmt.
It is confirmed that the product under test complies with the requirements for machines defined in Annex I of the EC Directive 2006/42/EC.

Gültig bis / Valid until 2025-05-28

Der Ausstellung dieses Zertifikates liegt eine Prüfung zugrunde, deren Ergebnisse im Bericht Nr. 968/FSP 2071.00/20 vom 28.05.2020 dokumentiert sind.
Dieses Zertifikat ist nur gültig für Erzeugnisse, die mit dem Prüfgegenstand übereinstimmen.
The issue of this certificate is based upon an examination, whose results are documented in Report No. 968/FSP 2071.00/20 dated 2020-05-28.
This certificate is valid only for products which are identical with the product tested.



Köln, 2020-05-28

Notified Body for Machinery, NB 0035



Dipl.-Ing. Jelena Stenzel

www.fs-products.com
www.tuv.com



TÜVRheinland®
Precisely Right.

10222.12.14.E A4 © TÜV, TUEV and TUV are registered trademarks. Utilisation and application requires prior approval.

TÜV Rheinland Industrie Service GmbH, An Gemarken Stein, 51105 Köln, Germany
Tel.: +49 221 895-2434, Fax: +49 221 895-1354, E-Mail: industrie-service@de.tuv.com

Figure 95: Certificate type examination

17 Revision history

Date:	Revision:	Note:
26.11.2014	01	Pre-series version
27.11.2014	01	Images replaced by links
27.11.2014	01	Changes in the texts
10.04.2015	01	Firmware 1.1.3, Changes in the texts; Changeover to revision 02
07.09.2016	02	Safety module type 3 first version of the manual. Creation documentID 20148769
28.03.2017	03	Referencing Fw V3.0.0.0 supplement FSoE descriptions
11.07.2017	04	SS1 revised. Formula of PT1 filter time simplified.
12.12.2017	04	Chapter 3.1 Validity of the material number adjusted. Chapter 4.1 Terminal Description Shield removed. Chapter 11.11 Description SLI next step without SLI. Chapter 11.12.1 Description SDI specified.
26.01.2018	05	Series version of the manual Inclusion of the type examination number Chapter 3.3 Supplement SAR and SSR Chapter 5.2.5 and 5.2.7 Note on import included.
20.02.2018	06	SICK SKM36S-HFA0-K02 Sine / Cosine encoder included as recommended encoder
02.05.2019	07	Chapter 3.3 SLR changed to SLS Chapters 8.3 to 8.7 SLI Activation and SLI Next Step corrected, selection of indices via configurable inputs newly described. Chapter 9.1 Note on functional test of OSSD signals included; Chapter 11.2 Bit 8 and 9 exchanged Chapter 11.5 SS1 functions renamed Chapter 11.15 Graphics modified p.102 Editorial changes

Belgium | KEB Automation KG
Herenveld 2 9500 Geraardsbergen Belgium
Tel: +32 544 37860 Fax: +32 544 37898
E-Mail: vb.belgien@keb.de Internet: www.keb.de

Brazil | KEB SOUTH AMERICA - Regional Manager
Rua Dr. Omar Pacheco Souza Riberio, 70
CEP 13569-430 Portal do Sol, São Carlos Brazil Tel: +55 16
31161294 E-Mail: roberto.arias@keb.de

P.R. China | KEB Power Transmission Technology (Shanghai) Co.
Ltd. No. 435 QianPu Road Chedun Town Songjiang District
201611 Shanghai P.R. China
Tel: +86 21 37746688 Fax: +86 21 37746600
E-Mail: info@keb.cn Internet: www.keb.cn

Germany | Headquarters
KEB Automation KG
Südstraße 38 32683 Barntrup Germany
Telefon +49 5263 401-0 Telefax +49 5263 401-116
Internet: www.keb.de E-Mail: info@keb.de

Deutschland | Geared Motors
KEB Antriebstechnik GmbH
Wildbacher Straße 5 08289 Schneeberg Germany
Telefon +49 3772 67-0 Telefax +49 3772 67-281
Internet: www.keb-drive.de E-Mail: info@keb-drive.de

France | Société Française KEB SASU
Z.I. de la Croix St. Nicolas 14, rue Gustave Eiffel
94510 La Queue en Brie France
Tel: +33 149620101 Fax: +33 145767495
E-Mail: info@keb.fr Internet: www.keb.fr

United Kingdom | KEB (UK) Ltd.
5 Morris Close Park Farm Industrial Estate
Wellingborough, Northants, NN8 6 XF United Kingdom
Tel: +44 1933 402220 Fax: +44 1933 400724
E-Mail: info@keb.co.uk Internet: www.keb.co.uk

Italia | KEB Italia S.r.l. Unipersonale
Via Newton, 2 20019 Settimo Milanese (Milano) Italia
Tel: +39 02 3353531 Fax: +39 02 33500790
E-Mail: info@keb.it Internet: www.keb.it

Japan | KEB Japan Ltd.
15 - 16, 2 - Chome, Takanawa Minato-ku
Tokyo 108 - 0074 Japan
Tel: +81 33 445-8515 Fax: +81 33 445-8215
E-Mail: info@keb.jp Internet: www.keb.jp

Austria | KEB Antriebstechnik Austria GmbH
Ritzstraße 8 4614 Marchtrenk Austria
Tel: +43 7243 53586-0 Fax: +43 7243 53586-21
E-Mail: info@keb.at Internet: www.keb.at

Russian Federation | KEB RUS Ltd.
Lesnaya str, house 30 Dzerzhinsky MO
140091 Moscow region Russian Federation
Tel: +7 495 6320217 Fax: +7 495 6320217
E-Mail: info@keb.ru Internet: www.keb.ru

Republic of Korea | KEB Automation KG
Room 1709, 415 Missy 2000 725 Su Seo Dong
Gangnam Gu 135- 757 Seoul Republik of Korea
Tel: +82 2 6253 6771 Fax: +82 2 6253 6770
E-Mail: vb.korea@keb.de

Spain | KEB Automation KG
c / Mitjer, Nave 8 - Pol. Ind. LA MASIA
08798 Sant Cugat Sesgarrigues (Barcelona) Spain
Tel: +34 93 8970268 Fax: +34 93 8992035
E-Mail: vb.espana@keb.de

United States | KEB America, Inc
5100 Valley Industrial Blvd. South Shakopee, MN 55379 United States
Tel: +1 952 2241400 Fax: +1 952 2241499
E-Mail: info@kebameric.com Internet: www.kebameric.com



WEITERE KEB PARTNER WELTWEIT:

www.keb.de/de/unternehmen/standorte-und-vertretungen



Automation mit Drive

www.keb.de

KEB Automation KG Südsraße 38 32683 Bartrup Tel. +49 5263 401-0 E-Mail: info@keb.de