



# COMBIVERT ACCESSORIES

INSTRUCTIONS FOR USE | INSTALLATION CAN ADAPTER GENERATION 6

Translation of the original manual  
Document 20264024 DE 02



# Preface

The hardware and software described in this document are products of KEB. The information contained in this document is valid at the time of publishing. KEB reserves the right to update this document in response to misprints, mistakes or technical changes.

## Signal words and symbols

Certain procedures within this document can cause safety hazards during the installation or operation of the device. Refer to the safety warnings in this document when performing these procedures. Safety signs are also located on the device where applicable. A safety warning is marked by one of the following warning signs:

<b>DANGER</b>	Dangerous situation, which will cause death or serious injury if this safety warning is ignored.
<b>WARNING</b>	Dangerous situation, which may cause death or serious injury if this safety warning is ignored.
<b>CAUTION</b>	Dangerous situation, which may cause minor injury if this safety warning is ignored.
<b>NOTICE</b>	Situation, which can cause damage to property if this safety warning is ignored.

### RESTRICTION

Used when the following statements depend on certain conditions or are only valid for certain ranges of values.



Used for informational messages or recommended procedures.

## More symbols

- ▶ This arrow starts an action step.
- / - Enumerations are marked with dots or indents.
- => Cross reference to another chapter or another page.



Note to further documentation.  
<https://www.keb-automation.com/search>



## Laws and guidelines

KEB Automation KG confirms with the EC declaration of conformity and the CE mark on the device nameplate that it complies with the essential safety requirements.

The EC declaration of conformity can be downloaded on demand via our website.

## Warranty and liability

The warranty and liability on design, material or workmanship for the acquired device is given in the general sales conditions.



Here you will find our general sales conditions.  
<https://www.keb-automation.com/terms-conditions>



Further agreements or specifications require a written confirmation.

## Support

Although multiple applications are referenced, not every case has been taking into account. If you require further information or if problems occur which are not referenced in the documentation, you can request the necessary information via the local KEB agency.

**The use of our units in the target products is outside of our control and therefore lies exclusively in the area of responsibility of the customer.**

The information contained in the technical documentation, as well as any user-specific advice in spoken and written and through tests, are made to best of our knowledge and information about the intended use. However, they are regarded as being only informal and changes are expressly reserved, in particular due to technical changes. This also applies to any violation of industrial property rights of a third-party. Selection of our units in view of their suitability for the intended use must be done generally by the user.

**Tests can only be done within the intended end use of the product (application) by the customer. They must be repeated, even if only parts of hardware, software or the unit adjustment are modified.**

## Copyright

The customer may use the instructions for use as well as further documents or parts from it for internal purposes. Copyrights are with KEB and remain valid in its entirety.

This KEB product or parts thereof may contain third-party software, including free and/or open source software. If applicable, the license terms of this software are contained in the instructions for use. The instructions for use are already available to you, can be downloaded free of charge from the KEB website or can be requested from the respective KEB contact person.

Other wordmarks or/and logos are trademarks (™) or registered trademarks (®) of their respective owners.

# Table of Contents

<b>Preface</b> .....	<b>3</b>
Signal words and symbols .....	3
More symbols.....	3
Laws and guidelines.....	4
Warranty and liability.....	4
Support .....	4
Copyright.....	4
<b>Table of Contents</b> .....	<b>5</b>
<b>List of Figures</b> .....	<b>6</b>
<b>List of Tables</b> .....	<b>6</b>
<b>1 Basic Safety Instructions</b> .....	<b>7</b>
1.1 Target group.....	7
1.1 Validity of this manual.....	7
<b>2 Product description</b> .....	<b>8</b>
2.1 Electrical data .....	8
2.1.1 Function overview .....	8
2.1.2 Device connections .....	8
2.2 Mechanical data.....	9
2.2.1 Dimensions.....	9
2.2.2 Control cabinet installation .....	9
<b>3 CAN bus</b> .....	<b>10</b>
3.1 CN1 CAN interface in / out.....	10
3.2 CN2 CAN interface in / out.....	10
3.3 Assignment CN1 and CN2 .....	10
3.4 CN3 CAN interface adapter socket in/out .....	10
3.4.1 Assignment CN3.....	11
3.4.2 CN3 CAN adapter cable.....	11
3.4.2.1 Assignment CAN adapter cable .....	11
<b>4 Device structure / design</b> .....	<b>12</b>
4.1 Colour code T568B.....	13
<b>5 Revision history</b> .....	<b>14</b>

## List of Figures

Figure 1:	Function overview .....	8
Figure 2:	Device connections.....	8
Figure 3:	Dimensions .....	9
Figure 4:	Control cabinet installation.....	9
Figure 5:	Device structure / design .....	12
Figure 6:	Colour code T568B .....	13

## List of Tables

Table 1:	Assignment CN1 and CN2.....	10
Table 2:	Assignment CN3.....	11
Table 3:	Assignment CAN adapter cable.....	11

# 1 Basic Safety Instructions

The products are designed and constructed in accordance with state-of-the-art technology and the recognized safety rules and regulations. However, the use of such devices may cause functional hazards for life and limb of the user or third parties, or damages to the system and other material property.

The following safety instructions have been created by the manufacturer for the area of electric drive technology. They can be supplemented by local, country- or application-specific safety instructions. This list is not exhaustive. Violation of the safety instructions by the customer, user or other third party leads to the loss of all resulting claims against the manufacturer.

## NOTICE



### Hazards and risks through ignorance!

- ▶ Read the instructions for use!
- ▶ Observe the safety and warning instructions!
- ▶ If anything is unclear, please contact KEB Automation KG!

## 1.1 Target group

This instruction manual is determined exclusively for electrical personnel. Electrical personnel for the purpose of this instruction manual must have the following qualifications:

- Knowledge and understanding of the safety instructions.
- Skills for installation and assembly.
- Start-up and operation of the product.
- Understanding of the function in the used machine.
- Detection of hazards and risks of the electrical drive technology.
- Knowledge of [VDE 0100](#)
- Knowledge of national safety regulations.

## 1.1 Validity of this manual

This manual describes the CAN adapter for the COMBIVERT Generation 6 series. The manual

- contains only supplementary safety instructions.
- is only valid in connection with the instructions for use „Installation“ of the corresponding COMBIVERT.

## 2 Product description

The CAN adapter (Pt. No. 0058025-0409) enables the easy connection of a Generation 6 drive controller to a CAN network made up of F5 CAN operators.

The CAN adapter provides an adaptation from a network consisting of D-Sub-9 connectors to an RJ45 cable for connection to the control terminal strip of a COMBIVERT F6 or S6 device.

### 2.1 Electrical data

The CAN adapter does not contain any active electronic components.



Information on required cables and maximum cable lengths are described in the corresponding control card manual.

#### 2.1.1 Function overview

The participants are connected via the CAN adapter as bus loop.

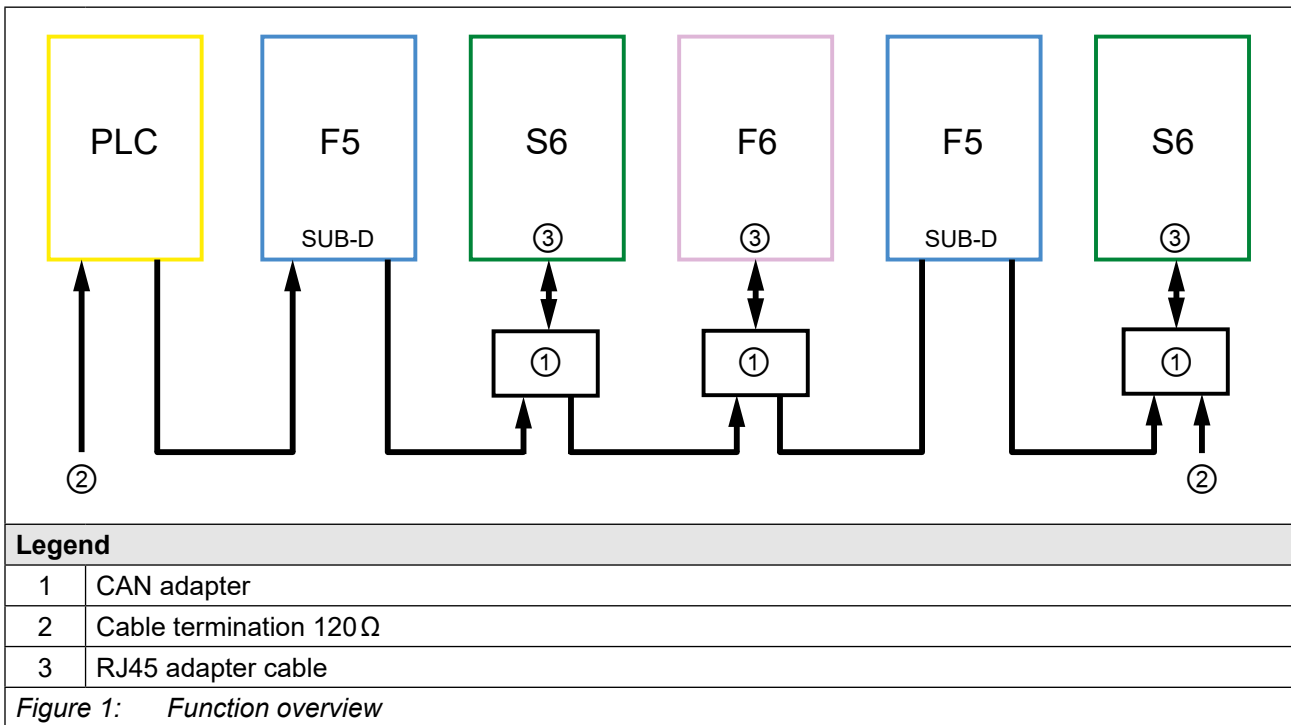

#### 2.1.2 Device connections

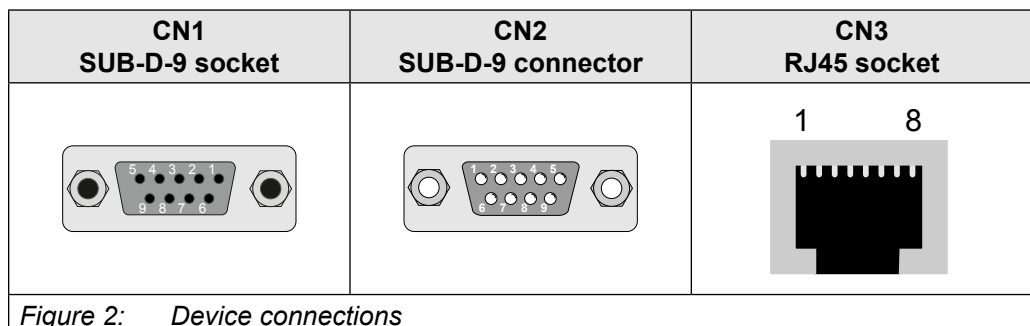



## 2.2 Mechanical data

### 2.2.1 Dimensions

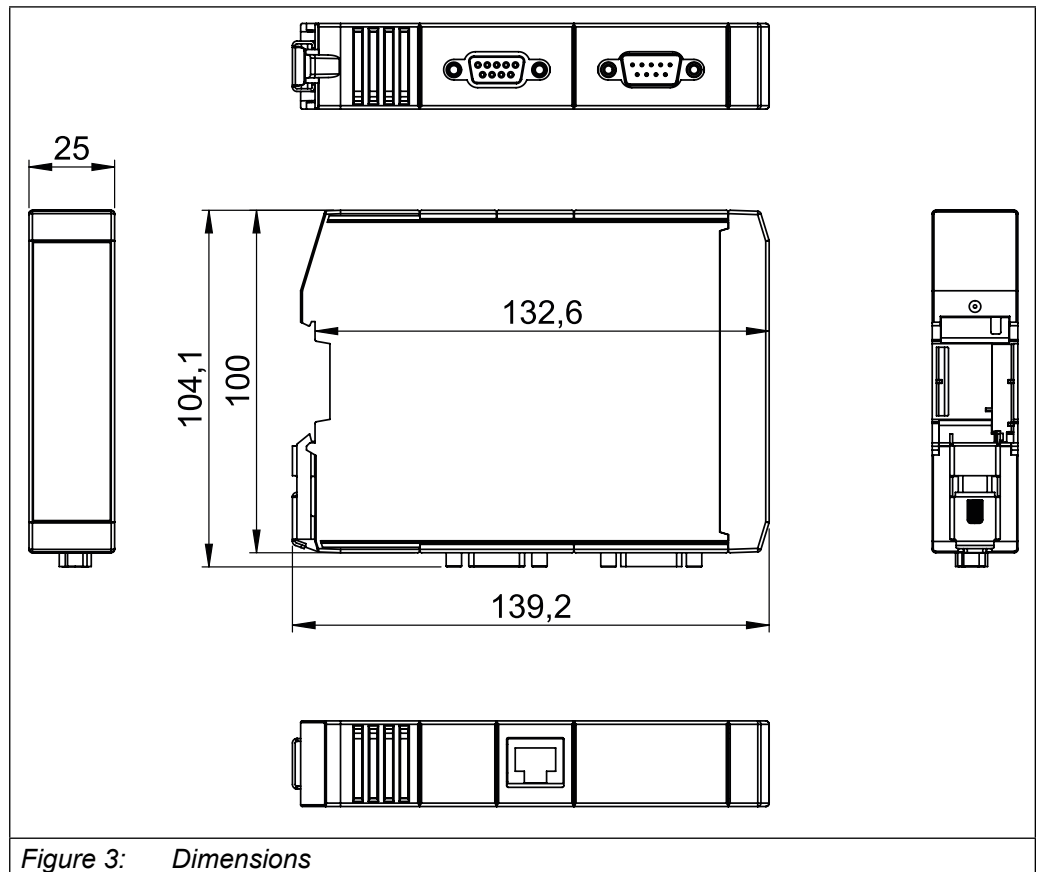

### 2.2.2 Control cabinet installation

The CAN adapter is provided for mounting on a mounting rail.

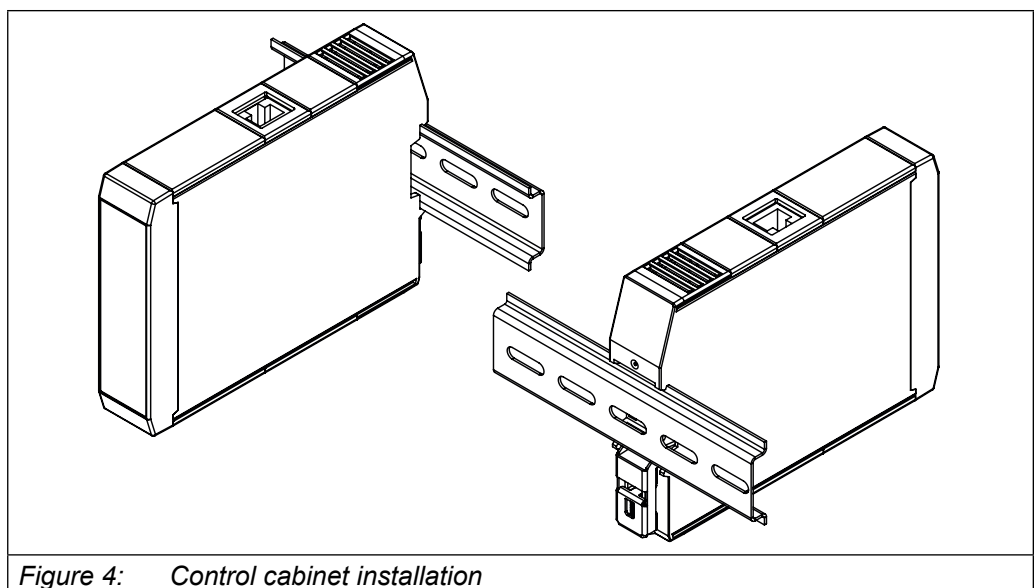

## 3 CAN bus

The CAN adapter provides a 9-pole D-Sub connector and a 9-pole D-Sub socket (according to *DIN41652 Part 1*) as well as a RJ45 socket for the CAN bus.

The bus participants are connected as bus loop via the connections CN1/CN2/CN3. The CAN adapter cable is therefore not a stub cable.

### 3.1 CN1 CAN interface in / out

D-Sub 9-pole socket, 2xUNC4-40 for fastening the connection cable.

### 3.2 CN2 CAN interface in / out

D-Sub 9-pole socket, 2xUNC4-40 for fastening the connection cable.

### 3.3 Assignment CN1 and CN2

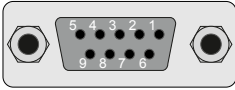
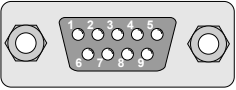
CN1/CN2	Signal	Description	CN1 SUB-D-9 socket	CN2 SUB-D-9 connector
1	—	Reserved		
2	CAN_L	CAN bus signal dominant low		
3	GND	CN1 and CN2 connected		
4	—	Not connected		
5	—	Not connected		
6	GND	CN1 and CN2 connected		
7	CAN_H	CAN bus signal dominant low		
8	—	Not connected		
9	—	Not connected		
Housing	Shield	CN1 and CN2 connected		

*Table 1: Assignment CN1 and CN2*

### 3.4 CN3 CAN interface adapter socket in/out

Enables simple connection via the CAN adapter cable to the control terminal block of a COMBIVERT.

- RJ45 socket, 8-pole, shielded
- CAT5-E

### 3.4.1 Assignment CN3

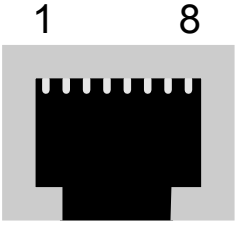
CN3	Signal	Description	RJ45 socket
1	CAN_H	CAN bus signal dominant high in/out	
2	CAN_L	CAN bus signal dominant low in/out	
3	—	Not connected	
4	CAN_L	CAN bus signal dominant low in/out	
5	CAN_H	CAN bus signal dominant high in/out	
6	—	Not connected	
7	—	Not connected	
8	—	Not connected	
Housing	Shield	Connected to CN1 / CN2 housing	

*Table 2: Assignment CN3*

### 3.4.2 CN3 CAN adapter cable

Enables simple connection of the CAN adapter to the control terminal block of a COMBIVERT. RJ45 cable, at least CAT5-E, RJ45 connector on 4 cables pressed together with two wire end ferrules.

- Part number: 0058E09-0409
- TYPE: minimum CAT5-E
- Length: 150 cm
- Colour: not specified (purple / blue)

#### 3.4.2.1 Assignment CAN adapter cable

CN3	Colour T568A	Colour T568B	Signal	Description	Adapter cable T568B
1	green/white	orange/white	CAN_H	CAN bus signal dominant high in/out	connected to pin 5
2	green	orange	CAN_L	CAN bus signal dominant low in/out	connected to pin 4
3	—	—	—	Not connected	—
4	blue	blue	CAN_L	CAN bus signal dominant low in/out	connected to pin 2
5	blue/white	blue/white	CAN_H	CAN bus signal dominant high in/out	connected to pin 1
6	—	—	—	Not connected	—
7	—	—	—	Not connected	—
8	—	—	—	Not connected	—
Housing	—	—	Shield	Connected to CN1 / CN2 housing	—

*Table 3: Assignment CAN adapter cable*

## 4 Device structure / design

The drawing is simplified, not drawn to scale and does not show all wire pairs of the CAN adapter cable.

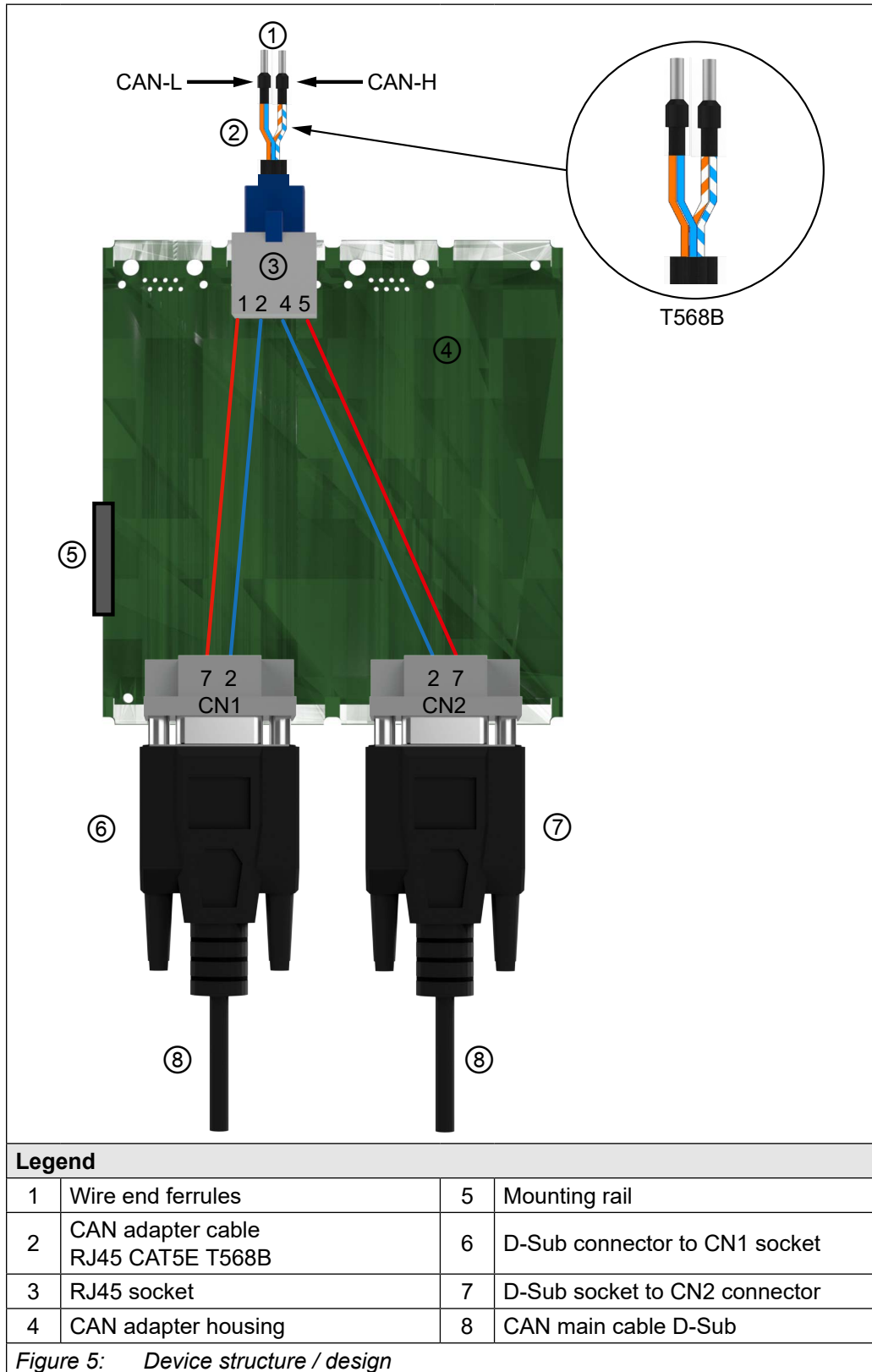

#### 4.1 Colour code T568B

The colours in => "Figure 5" of the CAN adapter cable correspond to the *T568B* standard.

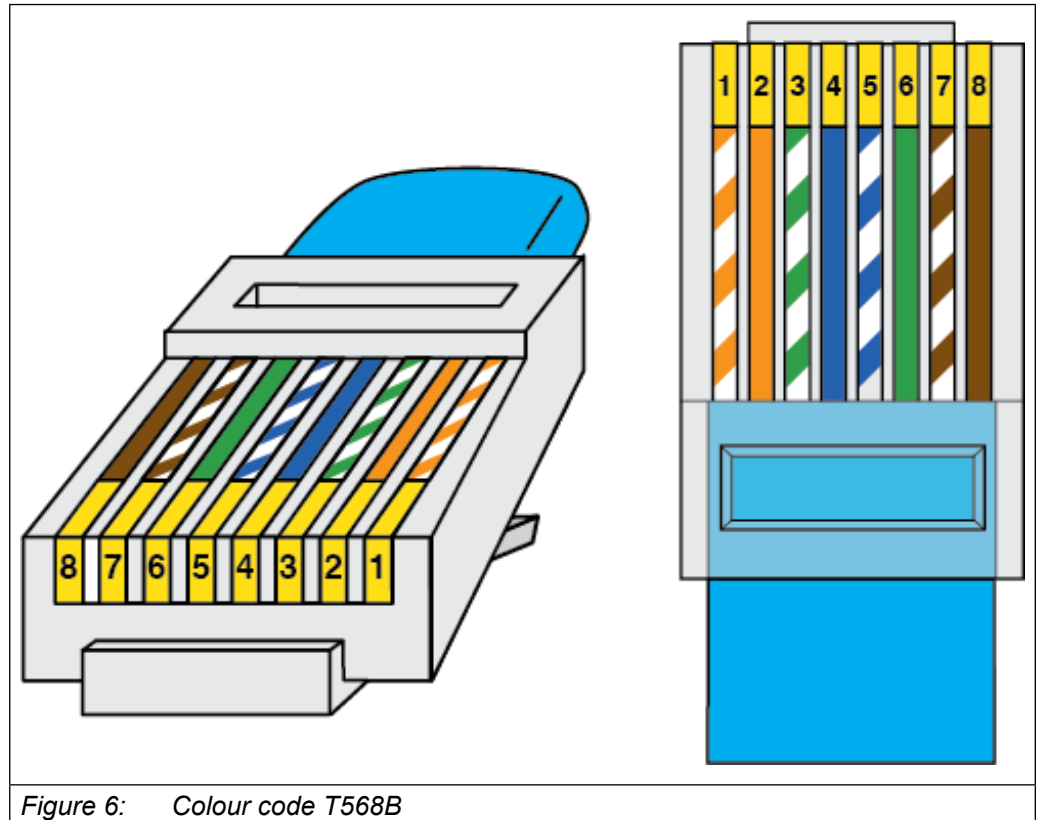

## 5 Revision history

Version	Date	Description
00	2021-05	Pre-series
01	2022-04	Series version
02	2024-11	Adapter cable part number added, editorial changes



**MORE KEB PARTNERS WORLDWIDE:**

[www.keb-automation.com/contact](http://www.keb-automation.com/contact)





**Automation with Drive**

**[www.keb-automation.com](http://www.keb-automation.com)**

KEB Automation KG Suedstrasse 38 D-32683 Barntrop Tel. +49 5263 401-0 E-Mail: [info@keb.de](mailto:info@keb.de)