



COMBICONTROL C6

INSTRUCTIONS FOR USE | REMOTE I/Os

Translation of original manual
Document 20108678 EN 02



Preface

The described hard- and software are developments of the KEB Automation KG. The enclosed documents correspond to conditions valid at printing. Misprint, mistakes and technical changes reserved.

Signal words and symbols

Certain operations can cause hazards during the installation, operation or thereafter. There are safety informations in the documentation in front of these operations. Security signs are located on the device or machine. A warning contains signal words which are explained in the following table:

DANGER	Dangerous situation, which will cause death or serious injury in case of non-observance of this safety instruction.
WARNING	Dangerous situation, which may cause death or serious injury in case of non-observance of this safety instruction.
CAUTION	Dangerous situation, which may cause minor injury in case of non-observance of this safety instruction.
NOTICE	Situation, which can cause damage to property in case of non-observance.

RESTRICTION

Is used when certain conditions must meet the validity of statements or the result is limited to a certain validity range.



Is used when the result will be better, more economic or trouble-free by following these procedures.

More symbols

- ▶ This arrow starts an action step.
- / - Enumerations are marked with dots or indents.
- => Cross reference to another chapter or another page.



Note to further documentation.
www.keb.de/nc/search



Laws and guidelines

KEB Automation KG confirms with the EC declaration of conformity with the CE mark on the unit name plate, that the device complies with the essential safety requirements. The EC declaration of conformity can be downloaded on demand via our website. Further information is provided in chapter "Certification".

Warranty

The warranty on design, material or workmanship for the acquired device is given in the current terms and conditions.



Here you will find our current terms and conditions.
www.keb.de/terms-and-conditions



Further agreements or specifications require a written confirmation.

Support

Through multiple applications not every imaginable case has been taken into account. If you require further information or if problems occur which are not treated detailed in the documentation, you can request the necessary information via the local KEB Automation KG agency.

The use of our units in the target products is beyond of our control and therefore exclusively the responsibility of the machine manufacturer, system integrator or customer.

The information contained in the technical documentation, as well as any user-specific advice in spoken and written and through tests, are made to best of our knowledge and information about the application. However, they are considered for information only without responsibility. This also applies to any violation of industrial property rights of a third-party.

Selection of our units in view of their suitability for the intended use must be done generally by the user.

Tests can only be done within the application by the machine manufacturer. They must be repeated, even if only parts of hardware, software or the unit adjustment are modified.

Copyright

The customer may use the instruction manual as well as further documents or parts from it for internal purposes. Copyrights are with KEB Automation KG and remain valid in its entirety.

Other wordmarks or/and logos are trademarks (™) or registered trademarks (®) of their respective owners and are listed in the footnote on the first occurrence.

Table of Contents

Preface	3
Signal words and symbols	3
More symbols.....	3
Laws and guidelines.....	4
Warranty	4
Support	4
Copyright.....	4
Table of Contents	5
List of Figures	14
List of Tables	16
Glossary	17
Standards for control & automation	18
1 Basic Safety Instructions	20
1.1 Target Group	20
1.2 Transport, storage and proper use	21
1.3 Installation.....	21
1.5 Electrical connection	22
1.6 Start-up and operation	22
1.4 Location of installation	22
1.4.1 Temperature	22
1.4.2 Contamination	22
1.6.1 Impact and vibration	23
1.6.2 Electromagnetic interference.....	23
1.7 Special interference sources in the environment	23
1.7.1 Inductive actuators	23
1.8 Maintenance.....	23
1.9 Repair	24
1.10 Disposal.....	24
2 System Description	25
2.1 EtherCAT — Ethernet Control Automation Technology	25
2.2 C6 - Automation platform.....	25
2.3 C6 Remote I/O	25
2.4 General instructions.....	26
2.4.1 Bus coupler	26
2.4.2 I/O modules	26
3 Operation	27
3.1 Mechanical design.....	27

3.2 Earth	28
3.3 Installation	29
3.3.1 Mechanical Installation	29
3.3.1.1 To snap on a single module.....	29
3.3.1.2 To interconnect two modules	29
3.3.1.3 To disconnect two modules	29
3.3.1.4 To take down a single module	30
3.3.2 Assembly and distances.....	30
3.3.3 Electrical Installation.....	31
4 Bus coupler and Extender	32
4.1 Bus coupler.....	32
4.1.1 Terminals	32
4.1.2 Status LEDs	33
4.1.2.1 LED „EtherCAT Run“	33
4.1.2.2 LED „In L/A“, LED „Out L/A“	33
4.1.3 Function.....	33
4.1.3.1 Module state.....	33
4.1.4 Technical data	34
4.2 Bus coupler DI16/DO16.....	35
4.2.1 Terminals	36
4.2.2 Status LEDs	36
4.2.2.1 LED „EtherCAT Run“	36
4.2.2.2 LED „IO“	36
4.2.2.3 „Power“ LED	37
4.2.2.4 LED „In L/A“, LED „Out L/A“	37
4.2.2.5 LED „Channel“.....	37
4.2.3 Function.....	37
4.2.3.1 Module state.....	37
4.2.4 Technical data	38
4.3 Extender 2 Port.....	39
4.3.1 Terminals	40
4.3.2 Status LEDs	40
4.3.2.1 LED „EtherCAT Run“	40
4.3.2.2 LED „Out2“, LED „Out1“	40
4.3.3 Technical data	41
5 Digital KEB I/O moduls.....	42
5.1 DI16/DO16.....	42
5.1.1 Terminals	42
5.1.2 Status LEDs	43
5.1.2.1 LED „EtherCAT Run“	43

5.1.2.2 „IO“ LED	43
5.1.2.3 „Power“ LED	43
5.1.2.4 „Channel“ LEDs.....	43
5.1.3 Function.....	44
5.1.3.1 Variable	44
5.1.4 Technical data	44
5.2 DI16/DO16 LS (Low side)	45
5.2.1 Terminals	45
5.2.2 Status LEDs	45
5.2.2.1 LED „EtherCAT Run“	45
5.2.2.2 „IO“ LED	46
5.2.2.3 „Power“ LED	46
5.2.2.4 „Channel“ LEDs.....	46
5.2.3 Function.....	46
5.2.3.1 Variable	46
5.2.4 Technical data	47
5.3 DI32	48
5.3.1 Terminals	48
5.3.2 Status LEDs	48
5.3.2.1 LED „EtherCAT Run“	48
5.3.2.2 „IO“ LED	48
5.3.2.3 „Power“ LED	49
5.3.2.4 „Channel“ LEDs.....	49
5.3.3 Function.....	49
5.3.3.1 Variable	49
5.3.4 Technical data	49
5.4 DI16.....	50
5.4.1 Terminals	50
5.4.2 Status LEDs	50
5.4.2.1 LED „EtherCAT Run“	50
5.4.2.2 „IO“ LED	50
5.4.2.3 „Power“ LED	51
5.4.2.4 „Channel“ LEDs.....	51
5.4.3 Function.....	51
5.4.3.1 Variable	51
5.4.4 Technical data	51
5.5 DI16/DO8.....	52
5.5.1 Terminals	52
5.5.2 Status LEDs	52
5.5.2.1 LED „EtherCAT Run“	52
5.5.2.2 „IO“ LED	53
5.5.2.3 „Power“ LED	53
5.5.2.4 „Channel“ LEDs.....	53

5.5.3 Function.....	53
5.5.3.1 Variable	53
5.5.4 Technical data	54
5.6 DO16	55
5.6.1 Terminals	55
5.6.2 Status LEDs	55
5.6.2.1 LED „EtherCAT Run“	55
5.6.2.2 „IO“ LED	56
5.6.2.3 „Power“ LED	56
5.6.2.4 „Channel“ LEDs.....	56
5.6.3 Function.....	56
5.6.3.1 Variable	56
5.6.4 Technical data	57
5.7 DO8	58
5.7.1 Terminals	58
5.7.2 Status LEDs	58
5.7.2.1 LED „EtherCAT Run“	58
5.7.2.2 „IO“ LED	59
5.7.2.3 „Power“ LED	59
5.7.2.4 „Channel“ LEDs.....	59
5.7.3 Function.....	59
5.7.3.1 Variable	59
5.7.4 Technical data	60
5.8 DO8 Relay NO 24 V.....	61
5.8.1 Terminals	61
5.8.2 Status LEDs	61
5.8.2.1 LED „EtherCAT Run“	61
5.8.2.2 „IO“ LED	62
5.8.2.3 „Power“ LED	62
5.8.2.4 „Channel“ LEDs.....	62
5.8.3 Function.....	62
5.8.3.1 Variable	62
5.8.4 Technical data	63
5.9 DO8 Relay NO 230 VAC.....	64
5.9.1 Terminals	64
5.9.2 Status LEDs	64
5.9.2.1 LED „EtherCAT Run“	64
5.9.2.2 „IO“ LED	65
5.9.2.3 „Power“ LED	65
5.9.2.4 „Channel“ LEDs.....	65
5.9.3 Function.....	65
5.9.3.1 Variable	65
5.9.4 Technical data	66

6 Counter2	67
6.1 Counter2	67
6.1.1 Terminals	67
6.1.2 Status LEDs	68
6.1.2.1 LED „EtherCAT Run“	68
6.1.2.2 „IO“ LED	68
6.1.2.3 „Power“ LED	68
6.1.2.4 Status LEDs of the IOs	68
6.1.3 Function	69
6.1.3.1 Variable	70
6.1.3.2 Module status	70
6.1.3.3 Control/monitoring counter 1	70
6.1.4 Technical data	83
7 Counter/Posi2	84
7.1 Counter/Posi2	84
7.1.1 Terminals	84
7.1.2 Status LEDs	85
7.1.2.1 LED „EtherCAT Run“	85
7.1.2.2 „IO“ LED	85
7.1.2.3 „Power“ LED	85
7.1.2.4 Status LEDs of the IOs	85
7.1.3 Function	86
7.1.3.1 Variable	87
7.1.3.2 Module status	87
7.1.3.3 Control/monitoring counter 1	87
7.1.4 Technical data	102
8 Mixed Module	103
8.1 MIX02	103
8.1.1 Terminals	103
8.1.2 Status LEDs	104
8.1.2.1 LED „RN“	104
8.1.2.2 „IO“ LED	104
8.1.2.3 LED „PW“	104
8.1.3 Inputs	105
8.1.3.1 AnalogIn0	106
8.1.3.2 AnalogIn1	106
8.1.3.3 AnalogIn2	106
8.1.3.4 AnalogIn3	107
8.1.4 Outputs	108
8.1.5 Object Dictionary	109

8.1.6 Analog inputs / Oversampling..... 110
 8.1.7 Analog inputs / Oversampling SM synchronous..... 110
 8.1.8 Technical data 114

9 Analog KEB I/O Modules.....115

9.1 AO4-U/I - 16 Bit (CoE)..... 116
 9.1.1 Terminals 116
 9.1.2 Status LEDs 119
 9.1.2.1 LED „EtherCAT Run“ 119
 9.1.2.2 „IO“ LED 119
 9.1.2.3 „Power“ LED 119
 9.1.2.4 LED „Channel“..... 119
 9.1.3 Function..... 120
 9.1.4 StateWord 121
 9.1.5 Analog outputs..... 121
 9.1.6 ControlWord 121
 9.1.7 Object Dictionary 122
 9.1.8 Technical data 124
9.2 AI4/8-U 13 Bit (CoE)..... 125
 9.2.1 Status LEDs 125
 9.2.1.1 LED „EtherCAT Run“ 125
 9.2.1.2 „IO“ LED 126
 9.2.1.3 „Power“ LED 126
 9.2.1.4 LED „Channel“..... 126
 9.2.2 Function..... 127
 9.2.3 Adjust options 128
 9.2.4 Options 129
 9.2.5 StateWord 130
 9.2.6 Analog inputs..... 130
 9.2.7 ControlWord 130
 9.2.8 Object Dictionary 130
 9.2.9 Technical data 134
9.3 AI8/16-U 13 Bit (CoE)..... 135
 9.3.1 Status LEDs 136
 9.3.1.1 LED „EtherCAT Run“ 136
 9.3.1.2 „IO“ LED 136
 9.3.1.3 „Power“ LED 136
 9.3.1.4 LED „Channel“..... 136
 9.3.2 Function..... 137
 9.3.3 Adjust options 138
 9.3.4 Options 140
 9.3.5 StateWord 140

9.3.6 Analog inputs.....	140
9.3.7 ControlWord	140
9.3.8 Object Dictionary	141
9.3.9 Technical data	145
9.4 AI4-I - 12 Bit (CoE)	146
9.4.1 Status LEDs	147
9.4.1.1 LED „EtherCAT Run“	147
9.4.1.2 „IO“ LED	147
9.4.1.3 „Power“ LED	147
9.4.1.4 LED „Channel“	147
9.4.2 Function.....	148
9.4.3 Analog inputs.....	148
9.4.4 Measured value.....	148
9.4.5 Adjust options	149
9.4.6 Options	150
9.4.7 StateWord	151
9.4.8 Analog inputs.....	151
9.4.9 ControlWord	151
9.4.10 Object Dictionary	152
9.4.11 Technical data.....	154
9.5 AI8-I - 12 Bit (CoE)	155
9.5.1 Status LEDs	155
9.5.1.1 LED „EtherCAT Run“	155
9.5.1.2 „IO“ LED	156
9.5.1.3 „Power“ LED	156
9.5.1.4 LED „Channel“	156
9.5.2 Function.....	157
9.5.3 Analog inputs.....	157
9.5.4 Measured value.....	157
9.5.5 Options	158
9.5.6 StateWord	158
9.5.7 Analog inputs.....	159
9.5.8 ControlWord	159
9.5.9 Object Dictionary	160
9.5.10 Technical data	163
9.6 AI4-Pt/Ni/TC -16 Bit (CoE)	164
9.6.1 Status LEDs	165
9.6.1.1 LED „EtherCAT Run“	165
9.6.1.2 „IO“ LED	165
9.6.1.3 LED „Channel“	165
9.6.2 Function.....	166
9.6.3 Measured value.....	166

9.6.4 Adjust options	166
9.6.5 Options	169
9.6.6 StateWord	170
9.6.7 Analog inputs.....	170
9.6.8 ControlWord	170
9.6.9 Cold-junction compensation	170
9.6.10 Calibration	171
9.6.11 Object Dictionary	172
9.6.12 Technical data	176
9.7 AI8-Pt/Ni/TC - 16 Bit (CoE)	177
9.7.1 Status LEDs	178
9.7.1.1 LED „EtherCAT Run“	178
9.7.1.2 „IO“ LED	178
9.7.1.3 LED „Channel“	178
9.7.2 Function.....	179
9.7.3 Measured value.....	179
9.7.4 Adjust options.....	179
9.7.5 Options.....	181
9.7.6 StateWord	182
9.7.7 Analog inputs.....	182
9.7.8 ControlWord	183
9.7.9 Cold-junction compensation	183
9.7.10 Calibration	183
9.7.11 Object Dictionary	184
9.7.12 Technical data	190
10 Multi Fieldbus Interface.....	191
10.1 PROFINET-Slave - Technical Data.....	191
10.2 EtherCAT-Slave - Technical Data	193
10.3 Ethernet-IP-Slave - Technical Data	195
10.4 POWERLINK-Slave - Technical Data.....	197
11 Drive Control Stepper.....	199
11.1 Technical data	199
12 Safety PLC.....	201
12.1 Technical data.....	201
13 EtherCAT Safe-IN4 / Safe-Out2.....	203
13.1 Technical data.....	203
14 Accessories.....	205

14.1 Shielding clamps	205
14.1.1 Terminals	206
14.1.2 I/O modules	206
15 Configuration with COMBIVIS studio 6	207
15.1 Offline configuration	207
16 Change history.....	208
17 Configuration with EtherCAT Technology Group Configurator	209
17.1 Offline configuration	209
18 Annex.....	211
18.1 Ordering data	211
19 Certification.....	213
19.1 Mark of conformity	213
19.2 UL approval.....	215
19.3 RoHs Declaration of Conformity	216

List of Figures

Figure 1:	C6 Remote I/O bus coupler with I/O modules.....	25
Figure 2:	Assembly and distances	30
Figure 3:	Bus coupler - Material No. 00C6CA1-0100.....	32
Figure 4:	Bus coupler DI16/DO16 - Material No. 00C6CA1-0200.....	35
Figure 5:	Extender 2 Port - Material No. 00C6CF1-0100.....	39
Figure 6:	Extender 2 Port - Material No. 00C6CF1-0100.....	40
Figure 7:	DI16/DO16 - Material No. 00C6CB1-0600.....	42
Figure 8:	DI16/DO16 LS - Material No. 00C6CB1-1800	45
Figure 9:	DI32 - Material No. 00C6CB1-0200	48
Figure 10:	DI16 - Material No. 00C6CB1-0100	50
Figure 11:	DI16/DO8 - Material No. 00C6CB1-0900.....	52
Figure 12:	DO16 - Material No. 00C6CB1-0500	55
Figure 13:	DO8 - Material No. 00C6CB1-1100	58
Figure 14:	DO8 Relay NO 24 V - Material No. 00C6CB1-2000	61
Figure 15:	DO8 Relay NO 230 V - Material No. 00C6CB1-1700	64
Figure 16:	Counter2 - Material No. 00C6CB1-0800.....	67
Figure 17:	Counter/Posi2 - Material No. 00C6CB1-1300.....	84
Figure 18:	I/O module MIX02 - Material No. 00C6CB1-1600.....	103
Figure 19:	Molex Micro Fit 4-pole socket	104
Figure 20:	Analog inputs / Oversampling.....	110
Figure 21:	I/O module AO4-U/I - Material No. 00C6CC1-1700	116
Figure 22:	DC-synchron (Distributed Clocks) / SM-synchron (Sync Manager).....	117
Figure 23:	Process data objects.....	117
Figure 24:	Runtime settings	118
Figure 25:	Add object.....	118
Figure 26:	I/O module AI4/8-U 13 Bit (CoE) - Material No. 00C6CC1-1500	125
Figure 27:	Adjust options	128
Figure 28:	Adjust options	128
Figure 29:	Settings.....	129
Figure 30:	I/O module AI4/8-U - Material No. 00C6CC1-1600.....	135
Figure 31:	Adjust options	138
Figure 32:	Adjust options	138
Figure 33:	Settings.....	139
Figure 34:	I/O module AI4-I - Material No. 00C6CC1-1300	146
Figure 35:	Measured values, variable value and status AI4-I CoE	148
Figure 36:	Adjust options	149
Figure 37:	Adjust options	149
Figure 38:	Settings.....	150
Figure 39:	I/O module AI8-I - Material No. 00C6CC1-1400	155
Figure 40:	Measured values, variable value and status AI8-I CoE	157
Figure 41:	I/O module AI4-Pt-Ni/Thermo - Material No. 00C6CC1-1800	164
Figure 42:	Adjust options	166
Figure 43:	Adjust options	167

Figure 44:	Settings	168
Figure 45:	I/O module AI8-Pt-Ni/Thermo - Material No. 00C6CC1-1900	177
Figure 46:	Adjust options	179
Figure 47:	Adjust options	180
Figure 48:	Settings	180
Figure 49:	PROFINET-PN-SLAVE - Material No. 00C6CH1-0200.....	191
Figure 50:	EtherCAT-EC-SLAVE - Material No. 00C6CH1-0300	193
Figure 51:	Ethernet-EI-SLAVE - Material No. 00C6CH1-0400.....	195
Figure 52:	POWERLINK-PL-SLAVE - Material No. 00C6CH1-0500.....	197
Figure 53:	Drive Control Stepper - Material No. 00C6CJ1-0100.....	199
Figure 54:	Safety PLC - Material No. 00C6CE1-0200	201
Figure 55:	EtherCAT Safe-IN4 / Safe-Out2 - Material No. 00C6CE1-0100	203
Figure 56:	Shielding clamps.....	205
Figure 57:	Spring-assisted connector with I/O module unlock button	205
Figure 58:	Terminals.....	206
Figure 59:	Spring-assisted connector with I/O module unlock button	206
Figure 60:	Configuration with COMBIVIS studio 6	207
Figure 61:	Offline configuration with EtherCAT	209

List of Tables

Glossary

0V	Earth-potential-free common point	MTTF	Mean service life to failure
1ph	1-phase mains	NN	Sea level
3ph	3-phase mains	PA	Potential equalization
AC	AC current or voltage	PE	Protective earth
ASCL	Asynchronous sensorless closed loop	PELV	Protective Extra Low Voltage
AWG	American wire gauge	PFD	Term used in the safety technology (EN 61508-1...7) for the size of error probability
B2B	Business-to-business	PFH	Term used in the safety technology (EN 61508-1...7) for the size of error probability per hour
CAN	Fieldbus system	PLC	Programmable logic controller
CODESYS	Operating system of the standard control and programming environment	Port	Part of a network address to the assignment of TCP and UDP connections
CODESYS Safety-PS	Safety programming system	POU	Program Organization Unit
COM-BIVERT	KEB drive converters	RJ45	Modular connector with 8 lines
COMBIVIS	KEB start-up and parameterizing software	Safety Package	Plug in for COMBIVIS studio 6 with safety functionality
DC	DC current or voltage	Safety PLC	Safety programmable logic controller
DIN	German Institut for standardization	Safety PLCopen	Library of the certified basic level safety blocks
EMC	Electromagnetic compatibility	SELV	Safety Extra Low Voltage (<60V)
Emergency stop	Shutdown of a drive in emergency case (not de-energized)	SIL	The security integrity level is a measure for quantifying the risk reduction. Term used in the safety technology (EN 61508 -1...7).
Emergency switching off	Switching off the voltage supply in emergency case	USB	Universal serial bus
EN	European standard		
EtherCAT	Real-time Ethernet bus system of the company Beckhoff		
Ethernet	Real-time bus system - defines protocols, plugs, types of cables		
FE	Functional earth		
FSoE	Functional Safety over Ethernet		
GND	Reference potential, ground		
Head module	Description for the bus coupler or small control in the KEB-I/O EtherCat system.		
HMI	Human machine interface (touch screen)		
IEC	International standard		
IP xx	Degree of protection (xx for level)		
KEB-I/O EtherCAT SPS	Small control system from the KEB-I/O system		
KEB-I/O EtherCAT System	I/O module family		
MCM	American unit for large wire cross sections		

Standards for control & automation

DGUV regulation 3	Electrical installations and equipment
DIN 46228-1	Wire-end ferrules; Tube without plastic sleeve
DIN 46228-4	Wire-end ferrules; Tube with plastic sleeve
DIN IEC 60364-5-54	Low-voltage electrical installations - Part 5-54: Selection and erection of electrical equipment - Earthing arrangements, protective conductors and protective bonding conductors (IEC 64/1610/CD)
DIN VDE 0100-729	Low-voltage electrical installations - Part 7-729: Requirements for special installations or locations - Operating or maintenance gangways (IEC 60364-7-729); German implementation HD 60364-7-729
EN 1037	Safety of machinery - Prevention of unexpected start-up; German version EN 1037
EN 55011	Industrial, scientific and medical equipment - Radio frequency disturbance characteristics - Limits and methods of measurement (IEC/CISPR 11); German version EN 55011
EN 55021	Interference to mobile radiocommunications in the presence of impulse noise - Methods of judging degradation and measures to improve performance (IEC/CISPR/D/230/FDIS); German version prEN 55021
EN 60204-1	Safety of machinery - electrical equipment of machines Part 1: General requirements (VDE 0113-1, IEC 44/709/CDV)
EN 60439-1	Low-voltage switchgear and controlgear assemblies - Part 1: Type-tested and partially type-tested assemblies (IEC 60439-1); German version EN 60439-1
EN 60529	Degrees of protection provided by enclosures (IP Code) (IEC 60529)
EN 60664-1	Insulation coordination for equipment within low-voltage systems Part 1: Principles, requirements and tests (IEC 60664-1)
EN 60721-3-1	Classification of environmental conditions - Part 3-1: Classification of groups of environmental parameters and their severities - Section 1: Storage (IEC 104/648/CD)
EN 60721-3-2	Classification of environmental conditions - Part 3: Classification of groups of environmental parameters and their severities - Section 2: Transportation and handling (IEC 104/670/CD)
EN 60721-3-3	Classification of environmental conditions - Part 3: Classification of groups of environmental parameters and their severities; section 3: Stationary use at weatherprotected locations; Amendment A2 (IEC 60721-3-3); German version EN 60721-3-3
EN 61000-2-1	Electromagnetic compatibility (EMC) - Part 2: Environment - Section 1: Description of the environment - Electromagnetic environment for low-frequency conducted disturbances and signalling in public power supply systems
EN 61000-2-4	Electromagnetic compatibility (EMC) - Part 2-4: Environment; Compatibility levels in industrial plants for low-frequency conducted disturbances (IEC 61000-2-4); German version EN 61000-2-4
EN 61000-4-2	Electromagnetic compatibility (EMC) - Part 4-2: Testing and measurement techniques - Electrostatic discharge immunity test (IEC 61000-4-2); German version EN 61000-4-2
EN 61000-4-3	Electromagnetic compatibility (EMC) - Part 4-3: Testing and measurement techniques - Radiated, radio-frequency, electromagnetic field immunity test (IEC 61000-4-3); German version EN 61000-4-3
EN 61000-4-4	Electromagnetic compatibility (EMC) - Part 4-4: Testing and measurement techniques - Electrical fast transient/burst immunity test (IEC 61000-4-4); German version EN 61000-4-4
EN 61000-4-5	Electromagnetic compatibility (EMC) - Part 4-5: Testing and measurement

EN61000-4-6	techniques - Surge immunity test (IEC 61000-4-5); German version EN 61000-4-5 Electromagnetic compatibility (EMC) - Part 4-6: Testing and measurement techniques - Immunity to conducted disturbances, induced by radio-frequency fields (IEC 61000-4-6); German version EN 61000-4-6
EN61000-4-34	Electromagnetic compatibility (EMC) - Part 4-34: Testing and measurement techniques - Voltage dips, short interruptions and voltage variations immunity tests for equipment with mains current more than 16 A per phase (IEC 61000-4-34); German version EN 61000-4-34
EN 61131-2	Programmable controllers - Part 2: Equipment requirements and tests (IEC 61131-2)
EN61373	Railway applications - Rolling stock equipment - Shock and vibration tests (IEC 61373)
EN61439-1	Low-voltage switchgear and controlgear assemblies - Part 1: General rules (IEC 121B/40/CDV); German version FprEN 61439-1
EN61508-1...7	Functional safety of electrical/electronic/programmable electronic safety-related systems – Part 1...7 (VDE 0803-1...7, IEC 61508-1...7)
EN61800-2	Adjustable speed electrical power drive systems - Part 2: General requirements - Rating specifications for low voltage adjustable frequency a.c. power drive systems (VDE 0160-102, IEC 61800-2)
EN61800-3	Speed-adjustable electrical drives. Part 3: EMC requirements and specific test methods (VDE 0160-103, IEC 61800-3)
EN61800-5-1	Adjustable speed electrical power drive systems - Part 5-1: Safety requirements - Electrical, thermal and energy (IEC 61800-5-1); German version EN 61800-5-1
EN61800-5-2	Adjustable speed electrical power drive systems - Part 5-2: Safety Requirements - Functional (IEC 22G/264/CD)
EN62061	Safety of machinery - functional safety of electrical, electronic and programmable electronic safety-related systems (VDE 0113-50, IEC 62061)
EN ISO 13849-1	Safety of machinery - safety-related parts of control systems - Part 1: General principles for design (ISO 13849-1); German version EN ISO 13849-1
UL61800-5-1	American version of the EN 61800-5-1 with „National Deviations“

1 Basic Safety Instructions

The COMBICONTROL is designed and constructed in accordance with state-of-the-art technology and the recognised safety rules and regulations. However, the use of such devices may cause functional hazards for life and limb of the user or third parties, or damages to the system and other material property.

The following safety instructions have been created by the manufacturer for the area of electric drive technology. They can be supplemented by local, country- or application-specific safety instructions. This list is not exhaustive. Non-observance of the safety instructions by the customer, user or other third party leads to the loss of all resulting claims against the manufacturer.

NOTICE

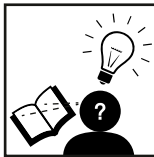

Hazards and risks through ignorance.

- ▶ Read the instructions for use !
- ▶ Observe the safety and warning instructions !
- ▶ If anything is unclear, please contact KEB Automation KG !

1.1 Target Group

This manual is written for design, project planning, servicing and commissioning experts. Qualified personnel for the purpose of this instruction manual must have the following qualifications:

- Knowledge and understanding of the safety instructions.
- Knowledge of automation technology.
- Knowledge of functional safety.
- Skills for installation and assembly of electrical equipment.
- Detection of hazards and risks of the electrical drive technology.
- Understanding of the function in the used machine.
- Knowledge of the operation of the Windows operating system.
- Knowledge of *DIN IEC 60364-5-54*.
- Knowledge of *EN 60204-1*
- Knowledge of national safety regulations (e.g. *DGUV regulation 3*).

1.2 Transport, storage and proper use

The transport is carried out by qualified persons in accordance with the environmental conditions specified in this manual. The devices shall be protected against excessive strains.



Electronic devices contain electrostatic sensitive components.

- ▶ Avoid contact.
- ▶ Wear ESD-protective clothing.

Do not store the devices

- in the environment of aggressive and/or conductive liquids or gases.
- with direct sunlight.
- outside the specified environmental conditions.

1.3 Installation

⚠ DANGER



Do not operate in an explosive environment!

- ▶ The device is not intended for the use in potentially explosive environment.

To prevent damages to the device:

- Make sure that no components are bent and/or isolation distances are changed.
- The device must not be put into operation in case of mechanical defects. Non-compliance with the applicable standards.
- Do not allow moisture or mist to penetrate the unit.
- Avoid dust permeating the device. Allow for sufficient heat dissipation if installed in a dust-proof housing.
- Note installation position and minimum distances to surrounding elements. Do not cover the ventilation openings.
- Mounting according to the specified degree of protection.
- Make sure that no small parts fall into the device during assembly and wiring (drilling chips, screws etc.). This also applies to mechanical components, which can lose small parts during operation.
- Check the reliable fit of the device connections in order to avoid contact resistances and sparking.
- The safety instructions are to be kept!

1.5 Electrical connection

ATTENTION

In order to prevent malfunctions or unpredictable conditions, observe the following instructions:

- ▶ For any work on the device switch off the supply voltage.
- ▶ Never bridge upstream protective devices (also not for test purposes).
- ▶ Install all required covers and protective devices for operation.
- ▶ The electrical installation shall be carried out in accordance with the relevant requirements.
- ▶ Cable cross-sections and fuses must be dimensioned according to the design of the machine manufacturer. Specified minimum / maximum values may not be fallen below /exceeded.
- ▶ With existing or newly wired circuits the person installing the units or machines must ensure the EN requirements are met.
- ▶ When using components without isolated inputs/outputs, it is necessary that equipotential bonding exists between the components to be connected (e.g. by the equipotential line). Disregard can cause destruction of the components by equalizing currents.

1.6 Start-up and operation

When the device is installed in machines, start-up (i.e. commencement of the intended operation) is prohibited until it is determined that the machine complies with the machine directive; Account is to be taken of [EN 60204-1](#).

- During operation, all covers and doors shall be kept closed.
- Use only approved accessories for this device.
- Never touch terminals, busbars or cable ends.

1.4 Location of installation

Ensure that temperatures, contaminations, impact, vibration and electromagnetic interference are no impediment to the installation.

1.4.1 Temperature

Consider heat sources such as general heating of rooms, sunlight, heat accumulation in assembly rooms or control cabinets.

1.4.2 Contamination

Use suitable housings to avoid possible negative influences due to humidity, corrosive gas, liquid and conductive dust.

1.6.1 Impact and vibration

Consider possible influences caused by motors, compressors, transfer lines, presses, ramming machines and vehicles.

1.6.2 Electromagnetic interference

Consider electromagnetic interference from various local sources: motors, switching devices, switching thyristors, radio-controlled devices, welding equipment, arcing, switched-mode power supplies, converters/inverters.

1.7 Special interference sources in the environment

1.7.1 Inductive actuators

Switching off inductances (such as from relays, contactors, solenoids or switching magnets) produce surge voltages. It is necessary to reduce these extra voltages to a minimum. Reducing elements may be diodes, Z-diodes, varistors and RC elements. For suitable dimensioning, the technical data of the manufacturer or supplier of the actuators must be observed.

1.8 Maintenance

The following maintenance work has to be carried out when required, but at least once per year by authorized and trained personnel. Check unit for loose screws and plugs and tighten if necessary.

- ▶ Check unit for loose screws and plugs and tighten if necessary.
- ▶ Clean the device from dirt and dust deposits. Depending on the device, pay particular attention to ventilation slots or cooling fins.
- ▶ Examine and clean extracted air filter and cooling air filter of the control cabinet.

1.9 Repair

In case of malfunction, unusual noises or smells inform a person in charge!

DANGER



Unauthorized exchange, repair and modifications!

Unpredictable malfunctions!

- ▶ The function of electronic devices can be influenced by the setting and parameterization. Never replace without knowledge of the application.
- ▶ Modification or repair is permitted only by KEB Automation KG authorized personnel.
- ▶ Only use original manufacturer parts.
- ▶ Infringement will annul the liability for resulting consequences.

1.10 Disposal

Electronic devices of the KEB Automation KG are exclusively professional devices for further industrial processing (so-called B2B devices).

Manufacturers of B2B devices are obliged to take back and recycle devices manufactured after 14.08.2018. These devices may not be disposed at the collection centres of public sector disposal organisations.



If no deviating agreement has been made between the customer and KEB or no deviating mandatory legal regulation exists, KEB products marked in this way can be returned. Company and keyword to the return point can be taken from the list below. Shipping costs are paid by the customer. Thereupon the devices will be professionally recycled and disposed.

The entry numbers are listed country-specific in the following table. The corresponding KEB return addresses can be found on our website.

Withdrawal by	WEEE-Reg.-No.	Keyword
Austria		
KEB Automation GmbH	ERA: 51976	Stichwort „Rücknahme WEEE“
France		
RÉCYLUM - Recycle point	ADEME: FR021806	Mots clés „KEB DEEE“
Germany		
KEB Automation KG	EAR: DE12653519	Stichwort „Rücknahme WEEE“
Italy		
COBAT	AEE: (IT) 19030000011216	Parola chiave „Ritiro RAEE“

The packaging must be feed to paper and cardboard recycling.

2 System Description

2.1 EtherCAT — Ethernet Control Automation Technology

EtherCAT is the most powerful Ethernet-based fieldbus system currently available on the market. EtherCAT puts up the top speed mark, and its flexible topology and simple configuration make it the perfect means of controlling extremely fast processes. To give you a clue: 1000 I/Os can be addressed in 30 μ s.

Because of its high performance, the simple wiring and its open protocol support, EtherCAT is often used as a fast motion control and I/O bus driven by an industrial PC or in conjunction with control technology on a smaller scale. EtherCAT moves beyond the limits of conventional fieldbus systems. Its interconnections between the controller at one end and both the I/O modules and drives at the other as fast as those of a backplane bus. EtherCAT controllers thus nearly act like centralised control systems, overcoming the issue of bus transfer times that conventional fieldbus systems are burdened with.

2.2 C6 - Automation platform

The automation platform C6 has been specifically engineered with applications near to machine in mind. C6 provides flexible automation solutions including hardware and software PLCs based around industrial PCs and embedded controls, remote I/Os, remote PLCs and decentralised drives. EtherCAT, PROFIBUS-DP and CANopen are supported for networking. C6 industrial PCs and Embedded controls as EtherCAT masters feature hard-coded real-time response and a CoDeSys PLC.

2.3 C6 Remote I/O

C6 Remote I/O is a system of I/O moduls for connecting the process signals to an EtherCAT network. C6 Remote I/O consists of the C6 Remote I/O bus coupler and a range of C6 Remote I/O modules.

The C6 Remote I/O bus coupler converts the physical transfer technology (twisted pair) to LVDS (E-bus) and generates the system voltages required by the LVDS modules. The standard 100 Base TX lines used for office network communications connect to the one side, the C6 Remote I/O modules for the process signals connect to the other. This is how the EtherCAT protocol is retained right through to the last I/O module. At the end of the modular device, the connection between the forward and return lines is automatically closed, the effect being that another 100 Base TX line can be plugged in to connect the next EtherCat unit to the second bus coupler port.

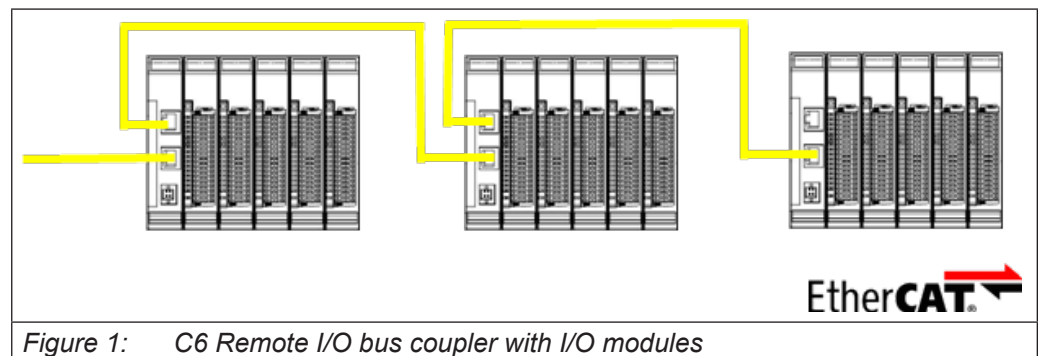

Figure 1: C6 Remote I/O bus coupler with I/O modules

2.4 General instructions

General spring-assisted blocks of sockets allow fast and simple wiring. A multiple socket connector densely packs the wires on a small footprint. Use the unlock button to easily disconnect the wires where there is little space.

Tool: blade screwdriver	0.4 x 2.5
Cores:	0.20 - 1.0 mm ² (IEC) / 28 - 18 AWG (UL)
rated current:	5 A (CSA) / 10 A (UL)

ATTENTION

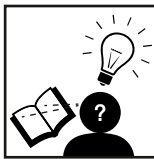

Dangers and risks

- ▶ *To ensure that there is as little interference as possible, install a central power supply point and establish a star topology of as short wires as possible between the central point and C6 Remote I/O. Do not connect the power supply lines through from one C6 Remote I/O power supply port to the next.*

2.4.1 Bus coupler

The system power supply connects to the bus coupler through a 2-pole plug-type terminal block. Since the bus coupler supplies power to both the E-bus and the logic circuits of the I/O modules, its power consumption depends on the number of connected I/O modules. Power to the I/O module outputs is supplied separately.

2.4.2 I/O modules

The I/O supply connects to the I/O module, normally together with the I/Os, using plug-type terminal blocks with different number of poles.

Power to the I/O module logic circuits is supplied by the bus coupler.

3 Operation

3.1 Mechanical design

For the basic layout of the C6 Remote I/O module see the picture below.

The bus coupler and the I/O modules differ in their connectors and indicators, however.

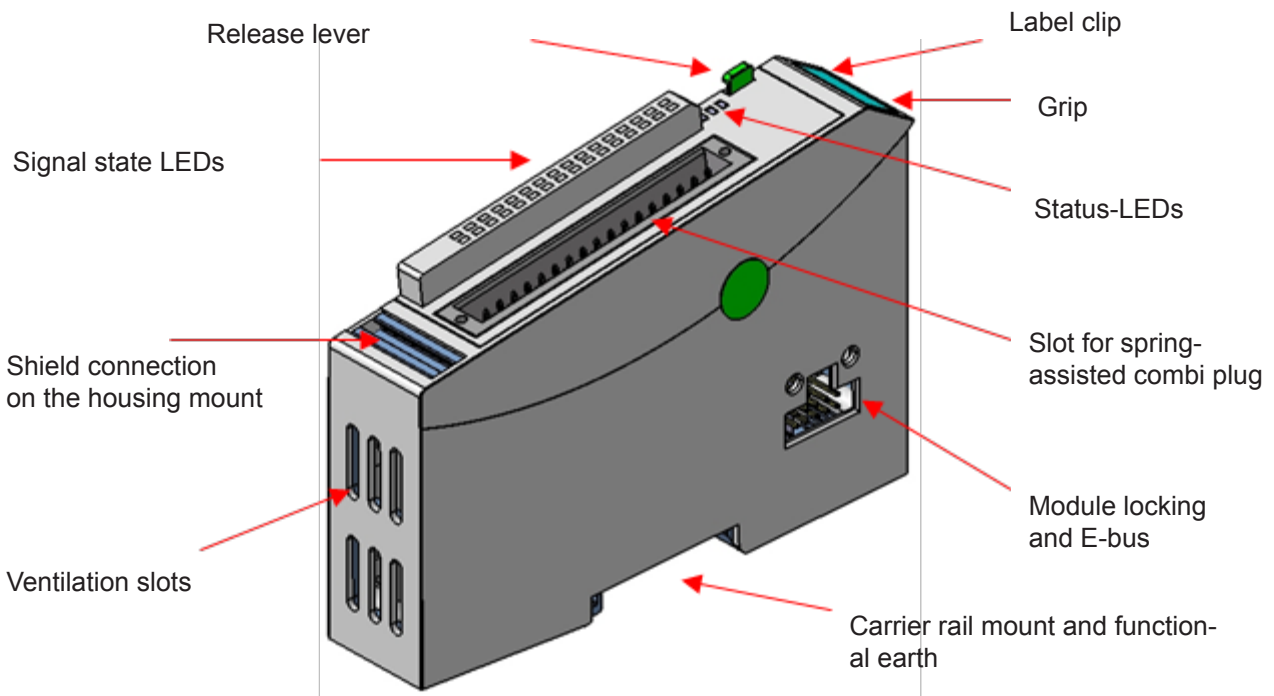

The housing mount consists of an aluminum profile with an integral snap-on device used to snap the module to a 35mm DIN mounting rail. The housing trough including the optical fibres for the status indicators, the side face and the front is made of plastic and contains the module. The optical fibre of the signal state indicators (LEDs) are located next to the spring-assisted combi plug. They slightly protrude from the housing and allow a clear diagnosis at a glance.

3.2 Earth

Since the operative earth connectors dissipate HF currents, it is of utmost importance for the module's noise immunity. HF interference is dissipated from the electronics board to the metal housing. The metal housing therefore needs to be suitably connected to an operative earth connector. You will normally have to ensure that:

- the connection between module housing and mounting rail conducts well
- the connection between mounting rail and control cabinet conducts well
- the control cabinet is safely connected to earth.

In special cases you may attach the earth wire straight to the module.

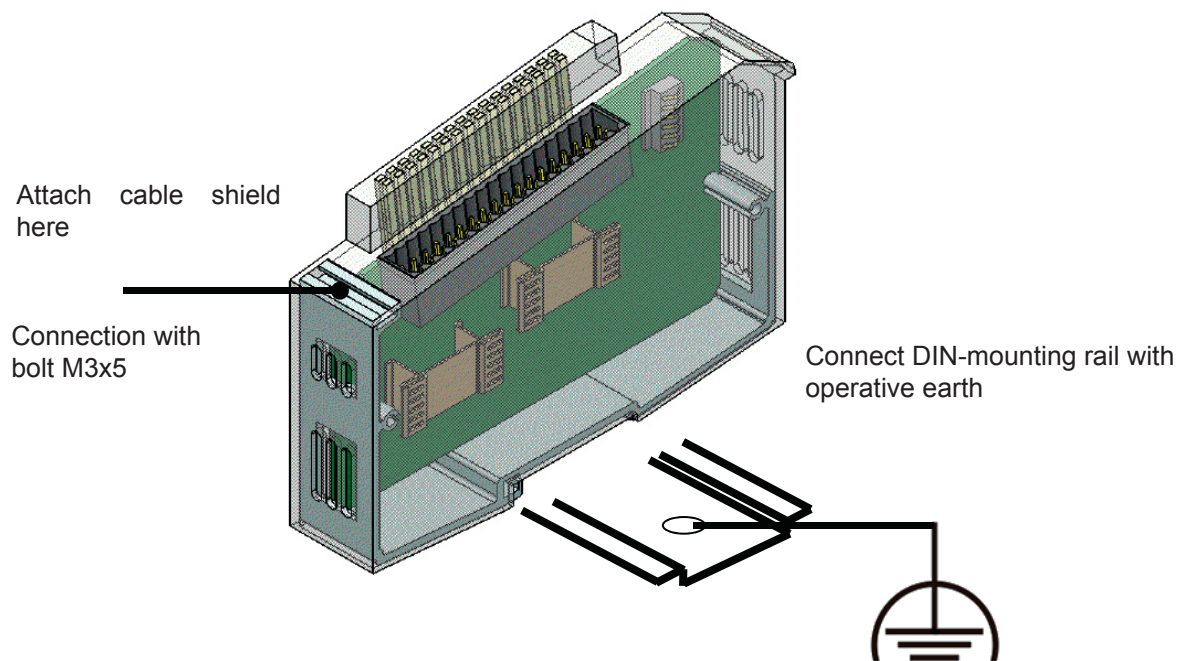

The functional earth should be short as possible and laid on a large surface.

3.3 Installation

3.3.1 Mechanical Installation

The I/O modules are intended for mounting rail installation (according DIN EN 50022, 35 x 7,5mm).

3.3.1.1 To snap on a single module

- Push the module against the mounting rail from below, allowing the metal spring to snap in between mounting rail and mounting areas as illustrated.
- Push the module against the mounting wall until it snaps in.

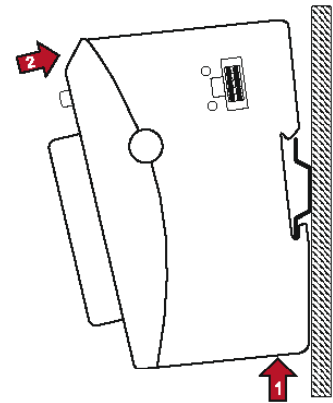

3.3.1.2 To interconnect two modules

- After you have snapped the first module on the mounting rail, snap the second module to the right in about 1cm distance to the first module on the mounting rail.
- Push the second module along the mounting rail towards the first module until you hear the locking device snap in.

3.3.1.3 To disconnect two modules

- Push down the unlock button of the module to be disconnected from the module to the left of it.
- Push the module to be removed to approx. 1 cm distance.

3.3.1.4 To take down a single module

- Push the module up and against the metal spring located on the under-side of the rail guide.
- Tip the module away from the mounting rail as shown in the illustration.
- Pull the module down and out of the mounting rail.

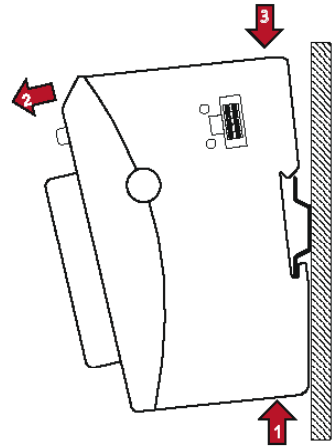

3.3.2 Assembly and distances

The device is designed to be mounted onto a DIN rail in closed cabinets and the like, which provide protection against fire hazards, environmental conditions and mechanical effects.

The mounting rail is mounted horizontally. The socket connector of the modules are facing forward. In order to ensure sufficient ventilation through the convection slots of the modules, the minimum distance of 20 mm upwards and 35 mm to adjacent devices and control cabinet surfaces must not fall below. The lateral distance to third-party devices and control cabinet surfaces must not be less than 20 mm.

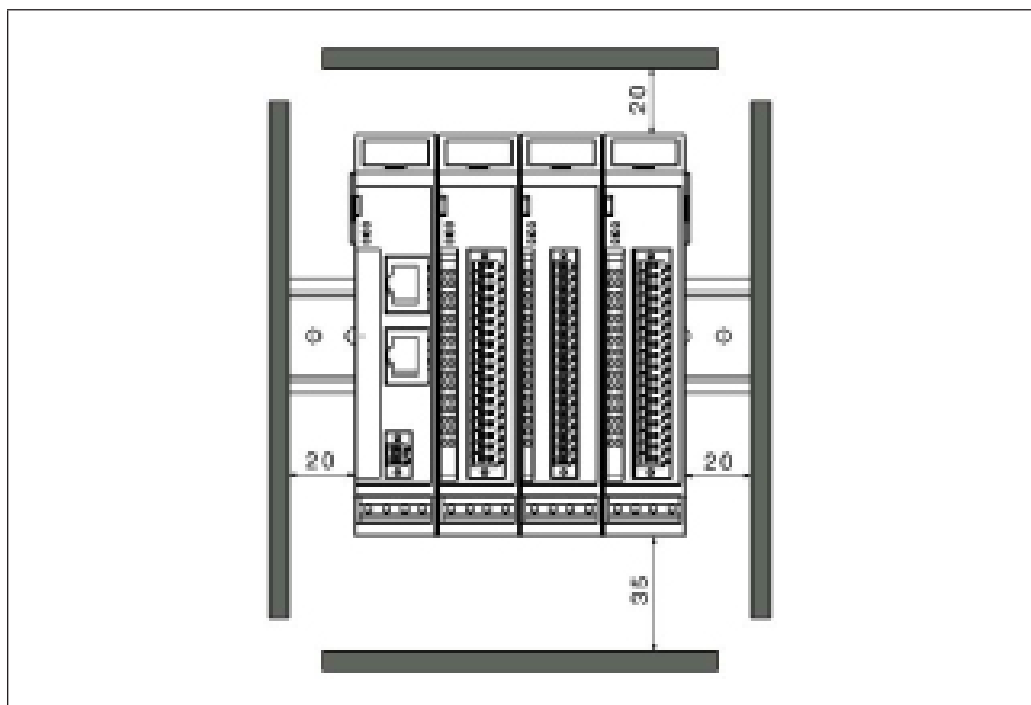

Figure 2: Assembly and distances

3.3.3 Electrical Installation

Module interconnection

The different modules connect electrically by pushing the individual modules together. This automatically connects them to the EtherCAT bus system and supplies power to the EtherCAT communication modules. Please note that the maximum current supplied by the bus coupler limits the number of KEB I/O modules you may connect to a single block.

The module does not require an external supply of 24Vdc. It is supplied via the internal E-bus connector.

A functional equipotential bonding serves, among other things, for large-area derivation of disturbances. This improves the interference immunity while reducing the emitted interference. This is done via a metallic foot in case of C6 Remote I/O modules, which locks into position on the mounting rail during mounting. The module does not require an external supply of 24Vdc. It is supplied via the internal E-bus connector.

A functional equipotential bonding serves, among other things, for large-area derivation of disturbances. This improves the interference immunity while reducing the emitted interference. This is done via a metallic foot in case of C6 Remote I/O modules, which locks into position on the mounting rail during mounting. The module requires only 24Vdc and implements the communication between different bus systems.

The module does not require an external 24Vdc supply and is supplied via the internal E-bus connector.

ATTENTION

Undefined conditions due to HF interference.

Pay attention on large well conducting connections between

- mounting rail and mounting plate,
- mounting plate and earthing.

4 Bus coupler and Extender

4.1 Bus coupler

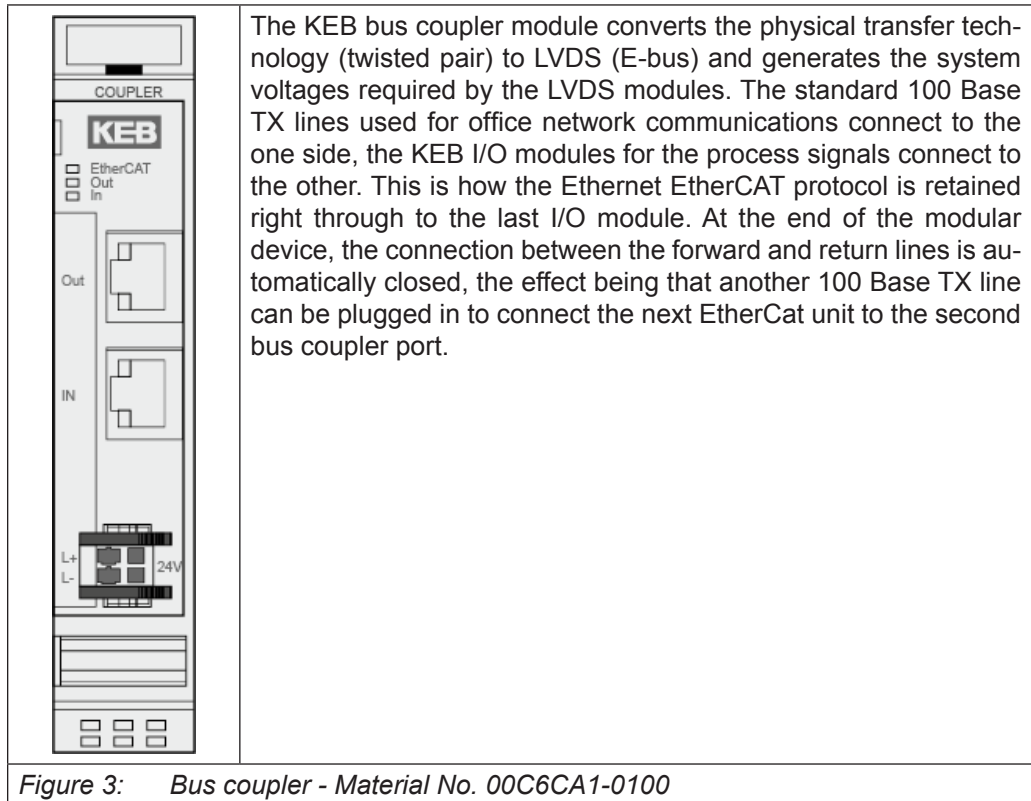

Figure 3: Bus coupler - Material No. 00C6CA1-0100

4.1.1 Terminals

Module supply

L+	24 VDC
L-	0V

EtherCAT

IN	RJ45 socket	Input (from previous EtherCAT station)
OUT	RJ45 socket	Output port (to the next EtherCAT device)

4.1.2 Status LEDs

4.1.2.1 LED „EtherCAT Run“

The LED labelled „EtherCAT Run“ indicates the state of the EtherCAT ASIC.

State	LED, flash code	Explanation
init	Red, on	Initialising, no data exchange
Pre-Op	Red/green, 1:1	Pre-operational, no data exchange
Safe-Op	Red/green, 3:1	Safe operation, inputs readable
Op	Green, on	Operational, unrestricted data exchange

4.1.2.2 LED „In L/A“, LED „Out L/A“

The „In L/A“-LED and „Out L/A“-LED indicate the physical state of the Ethernet ports they are allocated to (Link/Activity).



State	LED, flash code	Explanation
Not connected	Off	No Ethernet connection
Connected	Green, on	Connected to Ethernet
Traffic	Green, flashing	Exchanging telegrams

4.1.3 Function

4.1.3.1 Module state

Variable	Data type	Explanation
Undervoltage	BOOL	Low voltage (supplied power < 19.2V)

4.1.4 Technical data

Function	Connects a 100Base-TX EtherCAT with C6 remote I/O modules; Generates of LVDS system voltages		
Controller	ASIC ET1100		
Baud rate	100Mbit/s		
Cable	CAT5		
Cable length	max. 100m between two bus couplers		
Connector	EtherCAT 2 x RJ45		
Voltage supply	24V DC -20% +25%		
Connector Power	Plug 2-pole (part of the module)		
Input current	50 mA + E-bus power supply		
E-Bus power supply	max. 3A (approx. 20 modules)		
E-bus load	195mA		
Part no.	00C6CA1-0100		
Approvals			

4.2 Bus coupler DI16/DO16

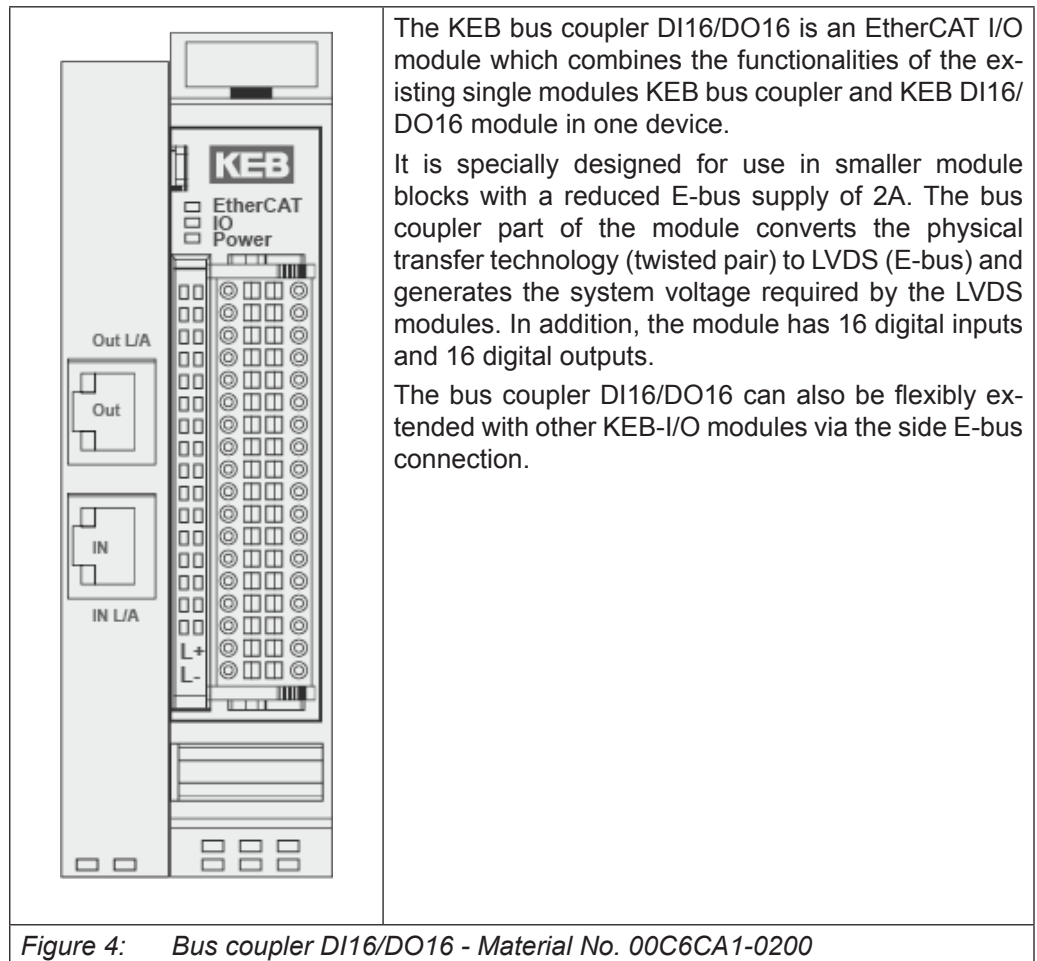

4.2.1 Terminals



24 V supply is required for the bus coupler and the second 24 V supply for part DI16/DO16.

Supply bus coupler		
L+ left	24 VDC	
L- left	0 VDC	
Supply DI16/DO16		
L+ right	24 VDC	
L- right	0 VDC	
EtherCAT		
IN	RJ45 socket	Input (from previous EtherCAT device)
OUT	RJ45 socket	Output (to the next EtherCAT device)



The best results with regard to emitted interference are obtained by connecting the shield of the EtherCAT cable to the functional earth.

4.2.2 Status LEDs

4.2.2.1 LED „EtherCAT Run“

The LED labelled „EtherCAT“ indicates the state of the EtherCAT ASIC.

4.2.2.2 LED „IO“

The LED labelled "IO" indicates the state of the module's I/Os.

State	LED, flash code	Explanation
OK	Off	No error
KS	Red, flashing light	Short-circuited digital output



The output drivers have a thermal fuse to automatically turn off any short-circuited outputs. In case the short circuit prevails, the outputs are allowed to cool down to be turned back on until the thermal fuse blows again.

4.2.2.3 „Power“ LED

The LED labelled "Power" indicates the state of the I/O power supply of the I/O module.
 Error! Reference source not found.



The module has undervoltage monitoring for logic and load!

4.2.2.4 LED „In L/A“, LED „Out L/A“

The „In L/A“-LED and „Out L/A“-LED indicate the physical state of the Ethernet port they are allocated to (Link/Activity).

State	LED, flash code	Explanation
Not connected	Off	No Ethernet connection
Connected	Green, on	Connected to Ethernet
Exchanging telegrams	Green, flashing	Exchanging telegrams

4.2.2.5 LED „Channel“



State	LED, flash code	Explanation
On	Green, on	Input signal TRUE / output enabled
Off	Off	Input signal FALSE / output enabled

4.2.3 Function

4.2.3.1 Module state

Variable	Data type	Explanation
U24_Load	BOOL	Low voltage (supplied power < 19.2V)
U24_Logic	BOOL	Low voltage (supplied power < 19.2V)
Shortcut Output	BOOL	Short-circuited digital output

4.2.4 Technical data

Function	Connects a 100Base-TX EtherCAT with C6 remote I/O modules; Generates of LVDS system voltages		
Controller	ASIC ET1100		
Baud rate	100Mbit/s		
Cable	CAT5		
Cable length	max. 100m between two bus couplers		
Connector	EtherCAT 2 x RJ45		
Voltage supply	24V DC -20% +25%		
Connector Power	Plug 2-pole (part of the module)		
Input current	50 mA + E-bus power supply		
E-Bus power supply	max. 2 A		
E-bus load	135mA		
Part no.	00C6CA1-0200		
Approvals			

4.3 Extender 2 Port

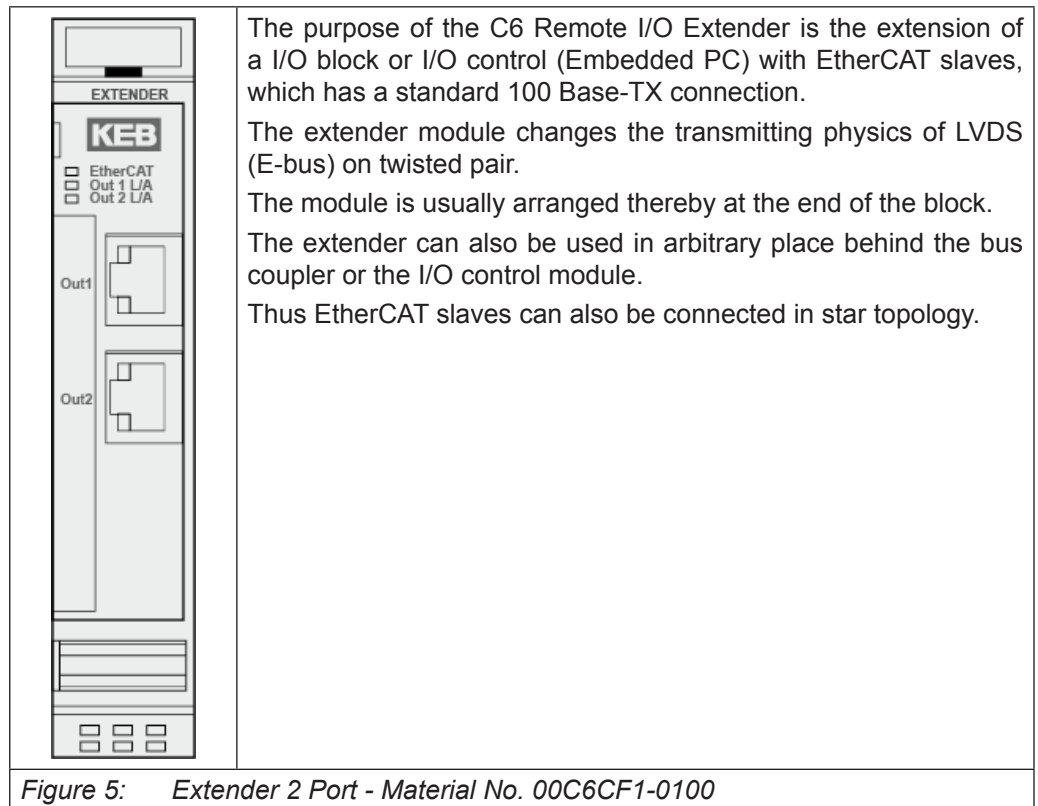

4.3.1 Terminals

The extender 2 port module has actually 4 ports. Name 2 port module was chosen because of the 2 standard 100 base-TX (OUT1, OUT2) RJ45 connections. Another 2 ports are covered by the E-bus.

It is important to the configuration in which sequence the connections are operated, i.e. which way the EtherCAT frame runs.

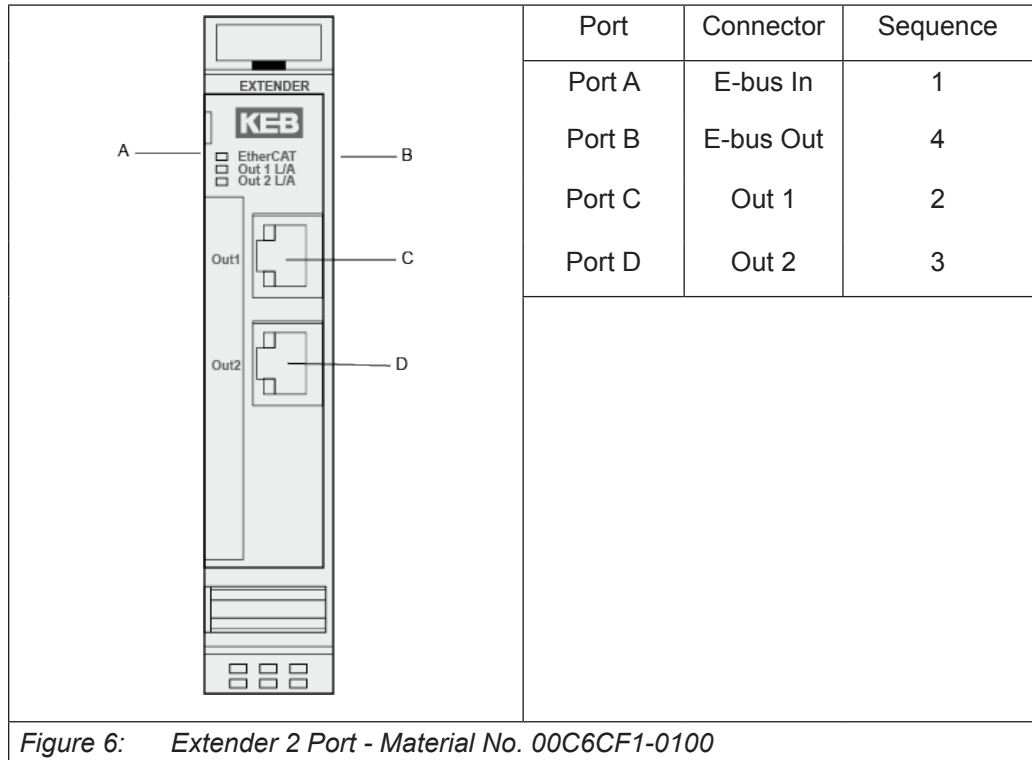

4.3.2 Status LEDs

4.3.2.1 LED „EtherCAT Run“

The LED labelled „EtherCAT“ indicates the state of the EtherCAT ASIC.

4.3.2.2 LED „Out2“, LED „Out1“

„Out2“-LED and „Out1“ LED indicate the physical state of the respective Ethernet port.

State	LED, flash code	Explanation
Not connected	Off	No Ethernet connection
Connected	Green, on	Connected to Ethernet
Exchanging telegrams	Green, flashing	Exchanging telegrams

4.3.3 Technical data

Function	Extension of a C6 I/O block or C6 Remote control (Embedded PC). Transformation of transmission physics from LVDS (E-bus) to 100Base-TX.		
Controller	ASIC ET1100		
Baud rate	100Mbit/s		
Cable	CAT5		
Cable length	max. 100 m		
Connector	EtherCAT 2 x RJ45		
Voltage supply	via E-bus		
Connector Power	Plug 2-pole (part of the module)		
E-bus load	160mA for Out1 / 210 mA for Out1+Out2		
Part no.	00C6CF1-0100		
Approvals			

5 Digital KEB I/O moduls

5.1 DI16/DO16

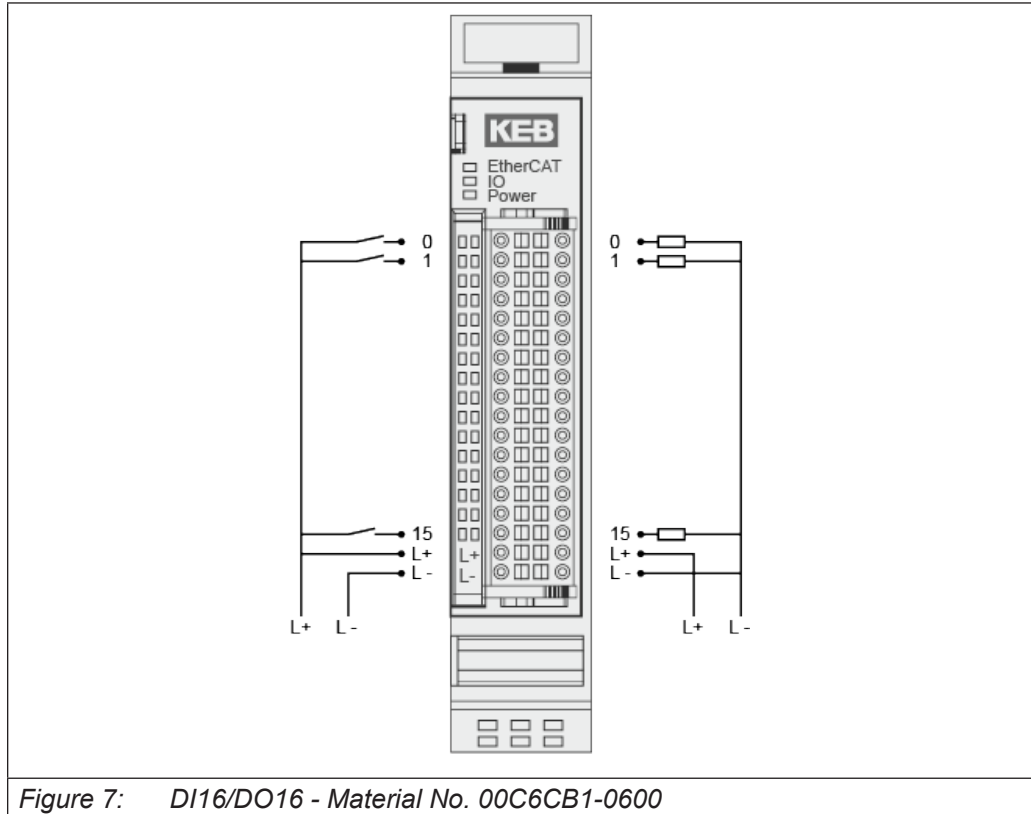

Figure 7: DI16/DO16 - Material No. 00C6CB1-0600

5.1.1 Terminals

Module supply

L+	24 VDC
L-	0V



Connect L+ to both L+ terminals if the total current exceeds the 6A limit.
The 2 terminals of L+ and L- are internally bridged!

5.1.2 Status LEDs

5.1.2.1 LED „EtherCAT Run“

The LED labelled „EtherCAT Run“ indicates the state of the EtherCAT ASIC.

State	LED, flash code	Explanation
init	Off	Initialising, no data exchange
Pre-Op	Off/green, 1:1	Pre-operational, no data exchange
Safe-Op	Off/green, 5:1	Safe operation, inputs readable
Op	Green, on	Operational, unrestricted data exchange

5.1.2.2 „IO“ LED

State	LED, flash code	Explanation
OK	Off	No error
KS	Red, on	Short-circuited digital output



The output drivers have a thermal fuse to automatically turn off any short-circuited outputs. In case the short circuit prevails, the outputs are allowed to cool down to be turned back on until the thermal fuse blows again.

5.1.2.3 „Power“ LED

The LED labelled "Power" indicates the state of the I/O module's I/O power supply.

State	LED, flash code	Explanation
On	Green, on	24 VDC supply available
Off	Off	24 VDC supply not available



The module is not monitored for low voltage states.

5.1.2.4 „Channel“ LEDs

State	LED, flash code	Explanation
On	Green, on	Input signal TRUE / output enabled
Off	Off	Input signal FALSE / output disabled



5.1.3 Function

The DI16/DO16 module features 16 digital inputs and 16 digital outputs.

5.1.3.1 Variable

Variable	Data type	Explanation
DigitalInputn	BOOL	Digital input (n=0...15)
DigitalOutputn	BOOL	Digital output (n=0...15)

5.1.4 Technical data

Digital inputs	16		
Input delay	1ms / 5ms (typically)		
Signal level	Off: -3 ... 5V		
	On: 15V ... 30V		
Digital outputs	16		
max. current	0.5A for each output		
Total current	max. 8A		
Connector I/O / Power	Connector 36-pole		
Controller	ASIC ET1200		
Baud rate	100 Mbit/s		
E-bus port	10-pin system plug in side wall		
Term. module	not required		
Voltage supply	24V DC -20% +25%		
E-bus load	135mA		
Part no.	00C6CB1-0600		
Approvals			

5.2 DI16/DO16 LS (Low side)

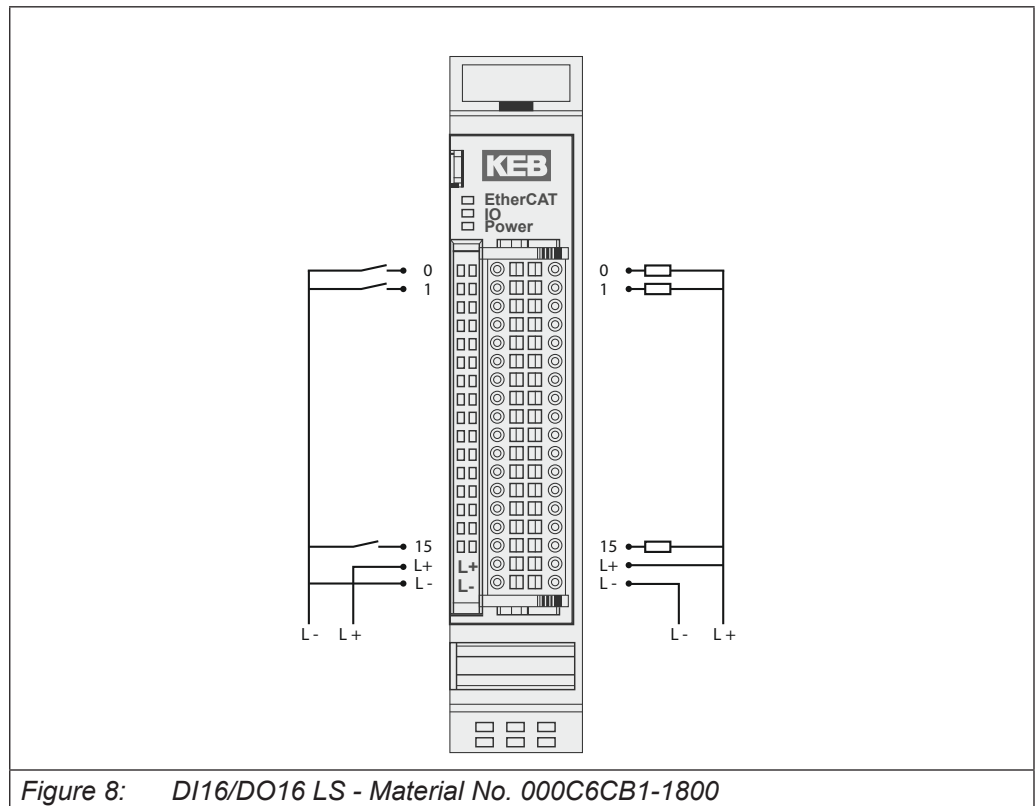

Figure 8: DI16/DO16 LS - Material No. 000C6CB1-1800

5.2.1 Terminals

Module supply

L+	24 VDC
L-	0V



Connect L+ to both L+ terminals if the total current exceeds the 6A limit.
The 2 terminals of L+ and L- are internally bridged!

5.2.2 Status LEDs

5.2.2.1 LED „EtherCAT Run“

The LED labelled „EtherCAT Run“ indicates the state of the EtherCAT ASIC.

State	LED, flash code	Explanation
init	Off	Initialising, no data exchange
Pre-Op	Off/green, 1:1	Pre-operational, no data exchange
Safe-Op	Off/green, 5:1	Safe operation, inputs readable
Op	Green, on	Operational, unrestricted data exchange

5.2.2.2 „IO“ LED

There is no LED labelled "IO".

5.2.2.3 „Power“ LED

The LED labelled "Power" indicates the state of the I/O module's I/O power supply.

State	LED, flash code	Explanation
On	Green, on	24 VDC supply available
Off	Off	24 VDC supply not available

5.2.2.4 „Channel“ LEDs

State	LED, flash code	Explanation
On	Green, on	Input signal Low (TRUE) / output enabled
Off	Off	Input signal High (FALSE) / output disabled

5.2.3 Function

The DI16/DO16 LS module features 16 digital low-side inputs and 16 digital low-side outputs.



The output drivers have a thermal fuse to automatically turn off any short-circuited outputs. In case the short circuit prevails, the outputs are allowed to cool down to be turned back on until the thermal fuse blows again.





The module is not monitored for low voltage states.

5.2.3.1 Variable

Variable	Data type	Explanation
DigitalInputn	BOOL	Digital input (n=0...15)
DigitalOutputn	BOOL	Digital output (n=0...15)

5.2.4 Technical data

Digital inputs	16		
Input delay	1ms (typically)		
Signal level	Off: -3 ... 5V		
	On: 15V ... 30V		
Input current	2mA (typically)		
Digital outputs	16		
max. current	0.5A for each output		
Total current	max. 8A		
Connector I/O / Power	Connector 36-pole		
Controller	ASIC ET1200		
Baud rate	100 Mbit/s		
E-bus port	10-pin system plug in side wall		
Term. module	not required		
Voltage supply	24V DC -20% +25%		
E-bus load	135mA		
Part no.	00C6CB1-1800		
Approvals			

5.3 DI32

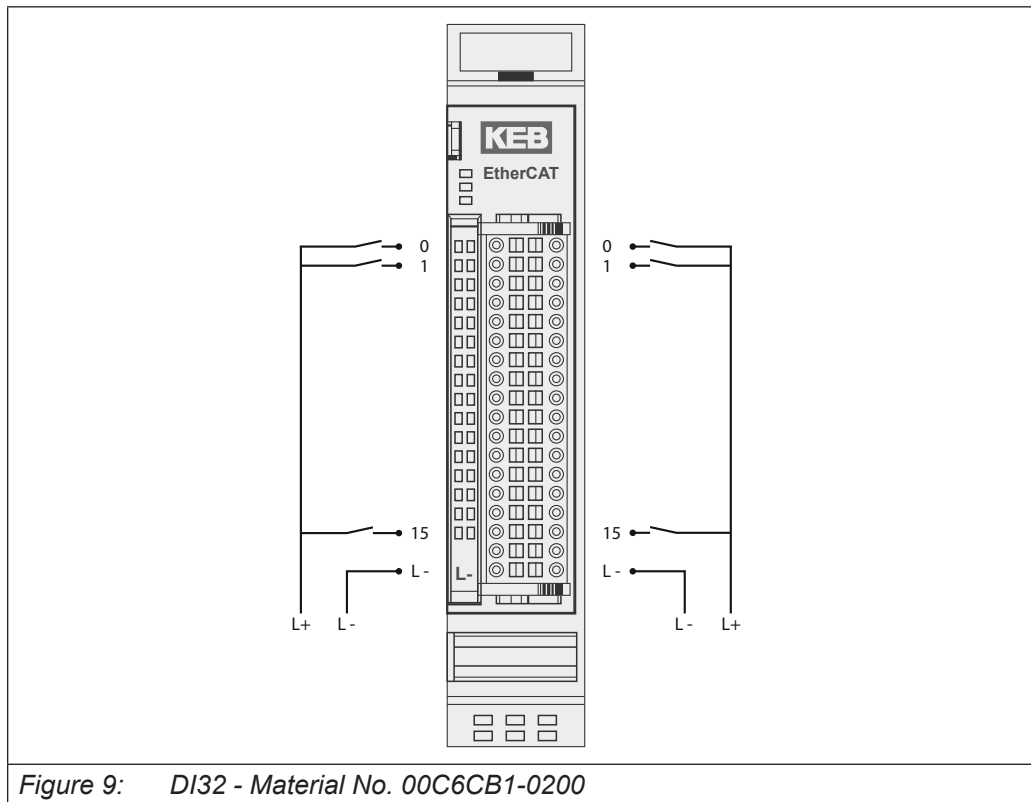

Figure 9: DI32 - Material No. 00C6CB1-0200

5.3.1 Terminals

Module supply

L-	0V
----	----

5.3.2 Status LEDs

5.3.2.1 LED „EtherCAT Run“

The LED labelled „EtherCAT Run“ indicates the state of the EtherCAT ASIC.

State	LED, flash code	Explanation
init	Off	Initialising, no data exchange
Pre-Op	Off/green, 1:1	Pre-operational, no data exchange
Safe-Op	Off/green, 5:1	Safe operation, inputs readable
Op	Green, on	Operational, unrestricted data exchange

5.3.2.2 „IO“ LED

There is no LED labelled "IO".

5.3.2.3 „Power“ LED

There is no LED labelled "Power" because a separate feed-in is not required.

5.3.2.4 „Channel“ LEDs

State	LED, flash code	Explanation
On	Green, on	Input signal TRUE
Off	Off	Input signal FALSE



5.3.3 Function

The module DI32 has 32 digital inputs.

5.3.3.1 Variable

Variable	Data type	Explanation
DigitalInputn	BOOL	Digital input (n=0...31)

5.3.4 Technical data

Digital inputs	32		
Input delay	1ms (typically)		
Signal level	Off: -3 ... 5V		
	On: 15V ... 30V		
Connector I/O / Power	Connector 36-pole		
Controller	ASIC ET1100		
Baud rate	100 Mbit/s		
E-bus port	10-pin system plug in side wall		
Term. module	not required		
Voltage supply	24V DC -20% +25%		
E-bus load	85mA		
Part no.	00C6CB1-0200		
Approvals			

5.4 DI16

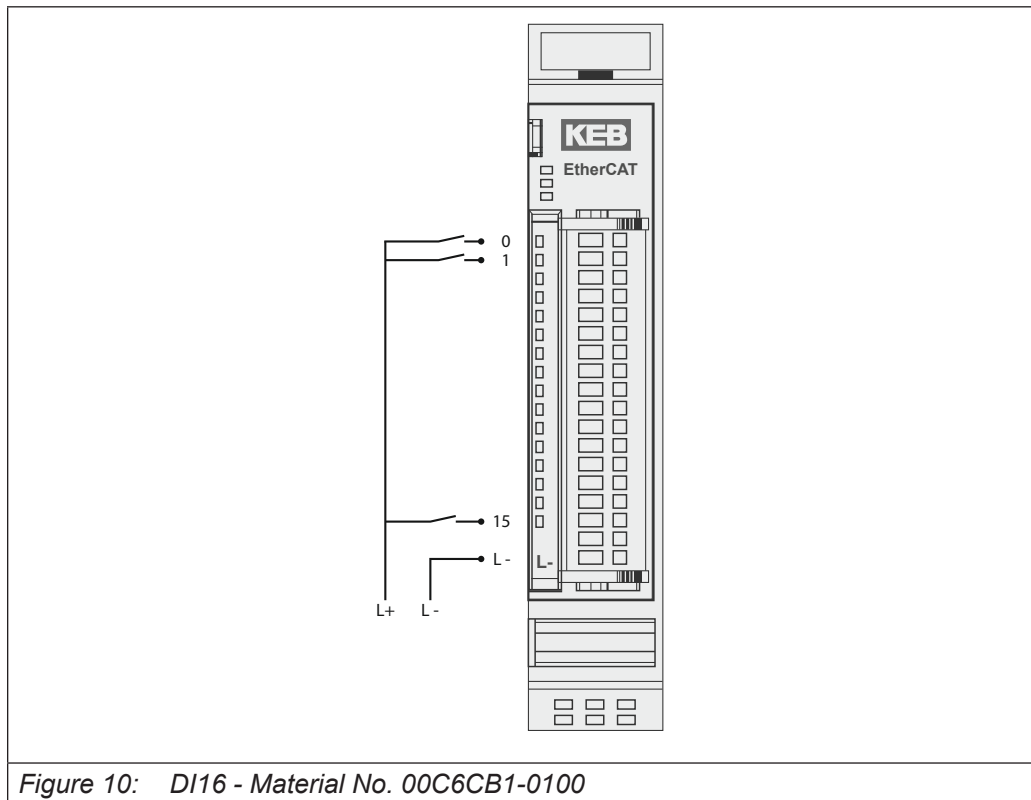

Figure 10: DI16 - Material No. 00C6CB1-0100

5.4.1 Terminals

Module supply

L-	0V
----	----

5.4.2 Status LEDs

5.4.2.1 LED „EtherCAT Run“

The LED labelled „EtherCAT Run“ indicates the state of the EtherCAT ASIC.

State	LED, flash code	Explanation
init	Off	Initialising, no data exchange
Pre-Op	Off/green, 1:1	Pre-operational, no data exchange
Safe-Op	Off/green, 5:1	Safe operation, inputs readable
Op	Green, on	Operational, unrestricted data exchange

5.4.2.2 „IO“ LED

There is no LED labelled "IO".

5.4.2.3 „Power“ LED

There is no LED labelled "Power" because a separate feed-in is not required.

5.4.2.4 „Channel“ LEDs

State	LED, flash code	Explanation
On	Green, on	Input signal TRUE
Off	Off	Input signal FALSE



5.4.3 Function

The DI16 module has 16 digital inputs.

5.4.3.1 Variable

Variable	Data type	Explanation
DigitalInputn	BOOL	Digital input (n=0...15)

5.4.4 Technical data

Digital inputs	16		
Input delay	1ms (typically)		
Signal level	Off: -3 ... 5V		
	On: 15V ... 30V		
Connector I/O / Power	Connector 18-pole		
Controller	ASIC ET1200		
Baud rate	100 Mbit/s		
E-bus port	10-pin system plug in side wall		
Term. module	not required		
Voltage supply	24V DC -20% +25%		
E-bus load	100mA		
Part no.	00C6CB1-0100		
Approvals		 LISTED Prog. Cntrl. E479848	 EtherCAT Conformance tested

5.5 DI16/DO8

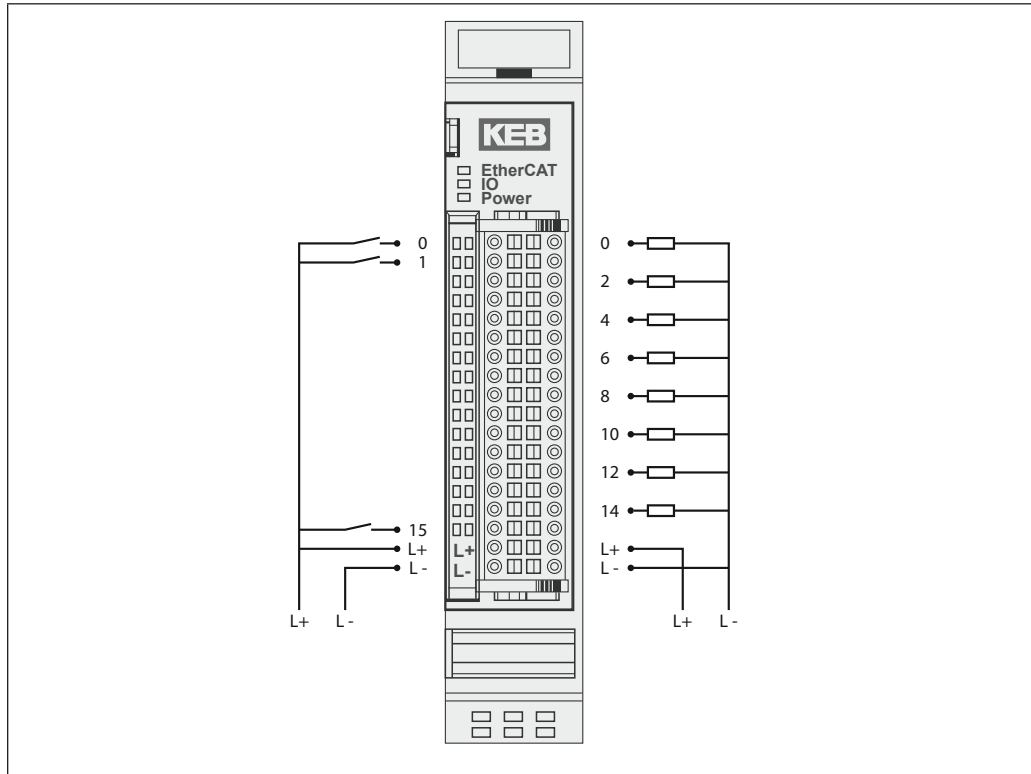

Figure 11: DI16/DO8 - Material No. 00C6CB1-0900

5.5.1 Terminals

Module supply

L+	24 VDC
L-	0V



Connect L+ to both L+ terminals if the total current exceeds the 6A limit.
The 2 terminals of L+ and L- are internally bridged!

5.5.2 Status LEDs

5.5.2.1 LED „EtherCAT Run“

The LED labelled „EtherCAT Run“ indicates the state of the EtherCAT ASIC.

State	LED, flash code	Explanation
init	Off	Initialising, no data exchange
Pre-Op	Off/green, 1:1	Pre-operational, no data exchange
Safe-Op	Off/green, 5:1	Safe operation, inputs readable
Op	Green, on	Operational, unrestricted data exchange

5.5.2.2 „IO“ LED

State	LED, flash code	Explanation
OK	Off	No error
KS	Red, on	Short-circuited digital output



The output drivers have a thermal fuse to automatically turn off any short-circuited outputs. In case the short circuit prevails, the outputs are allowed to cool down to be turned back on until the thermal fuse blows again.

5.5.2.3 „Power“ LED

The LED labelled "Power" indicates the state of the I/O module's I/O power supply.

State	LED, flash code	Explanation
On	Green, on	24 VDC supply available
Off	Off	24 VDC supply not available



The module is not monitored for low voltage states.

5.5.2.4 „Channel“ LEDs

State	LED, flash code	Explanation
On	Green, on	Input signal TRUE / output enabled
Off	Off	Input signal FALSE / output disabled



5.5.3 Function

The DI16/DO8 module features 16 digital inputs and 8 digital outputs.

5.5.3.1 Variable

Variable	Data type	Explanation
DigitalInputn	BOOL	Digital input (n=0...15)
DigitalOutputn	BOOL	Digital output (n=0...7)
reserved	BOOL	Unused output addresses

5.5.4 Technical data

Digital inputs	16		
Input delay	1ms (typically)		
Signal level	Off: -3 ... 5V		
	On: 15V ... 30V		
Digital outputs	8		
max. current	1.0A for each output		
Total current	max. 8A		
Connector I/O / Power	Connector 36-pole		
Controller	ASIC ET1200		
Baud rate	100 Mbit/s		
E-bus port	10-pin system plug in side wall		
Term. module	not required		
Voltage supply	24V DC -20% +25%		
E-bus load	135mA		
Part no.	00C6CB1-0900		
Approvals			

5.6 DO16

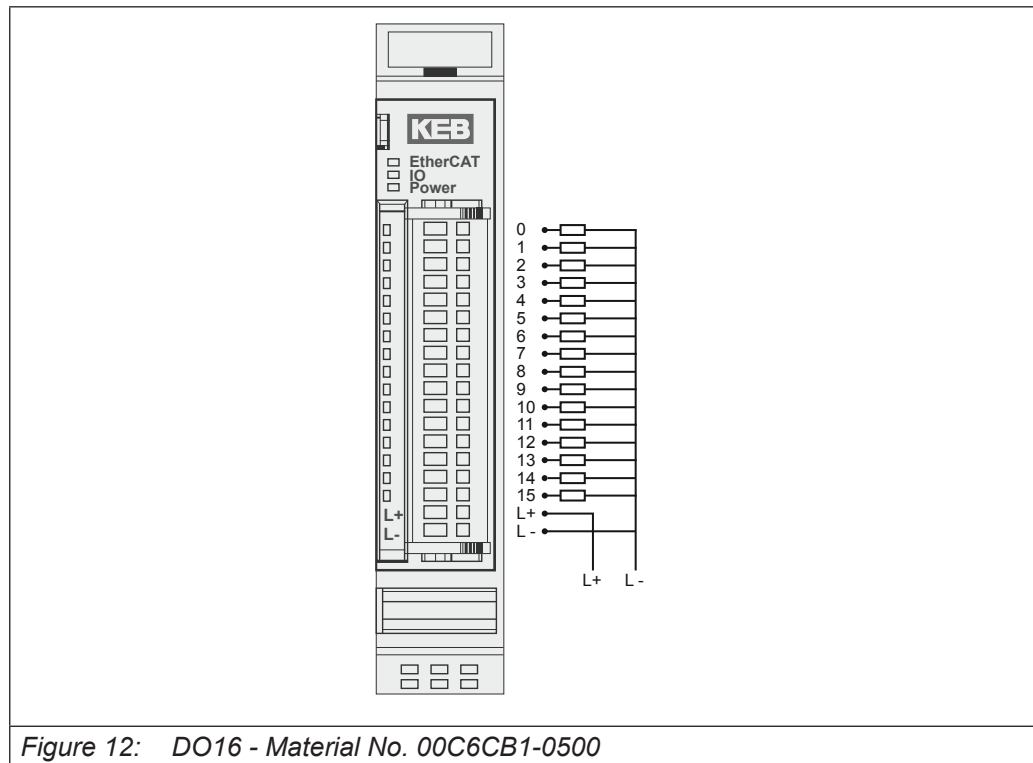

Figure 12: DO16 - Material No. 00C6CB1-0500

5.6.1 Terminals

Module supply

L+	24 VDC
L-	0V

5.6.2 Status LEDs

5.6.2.1 LED „EtherCAT Run“

The LED labelled „EtherCAT Run“ indicates the state of the EtherCAT ASIC.

State	LED, flash code	Explanation
init	Off	Initialising, no data exchange
Pre-Op	Off/green, 1:1	Pre-operational, no data exchange
Safe-Op	Off/green, 5:1	Safe operation, inputs readable
Op	Green, on	Operational, unrestricted data exchange

5.6.2.2 „IO“ LED

State	LED, flash code	Explanation
OK	Off	No error
KS	Red, on	Short-circuited digital output



The output drivers have a thermal fuse to automatically turn off any short-circuited outputs. In case the short circuit prevails, the outputs are allowed to cool down to be turned back on until the thermal fuse blows again.

5.6.2.3 „Power“ LED

The LED labelled "Power" indicates the state of the I/O module's I/O power supply.

State	LED, flash code	Explanation
On	Green, on	24 VDC supply available
Off	Off	24 VDC supply not available



The module is not monitored for low voltage states.

5.6.2.4 „Channel“ LEDs

State	LED, flash code	Explanation
On	Green, on	Output on
Off	Off	Output off



5.6.3 Function

The DO16 module has 16 digital outputs.

5.6.3.1 Variable

Variable	Data type	Explanation
DigitalOutputn	BOOL	Digital output (n=0...15)

5.6.4 Technical data

Digital outputs	16		
max. current	0.5A for each output		
Total current	max. 8A		
Connector I/O / Power	Connector 18-pole		
Controller	ASIC ET1200		
Baud rate	100 Mbit/s		
E-bus port	10-pin system plug in side wall		
Term. module	not required		
Voltage supply	24V DC -20% +25%		
E-bus load	130mA		
Part no.	00C6CB1-0500		
Approvals			

5.7 DO8

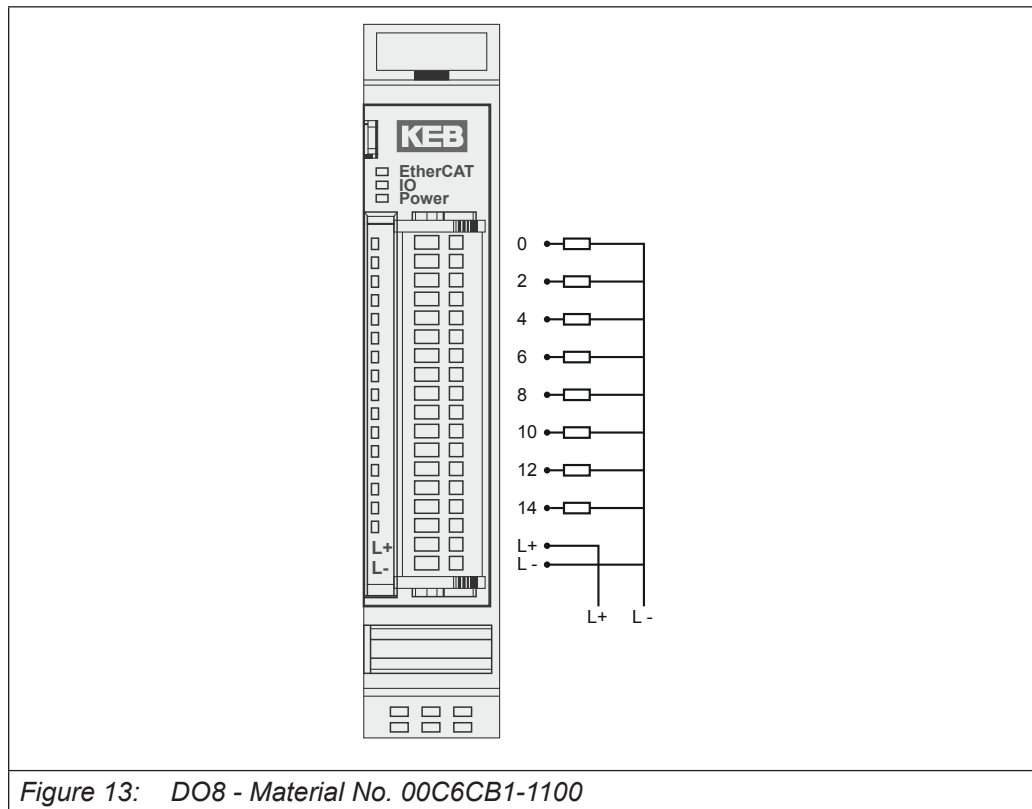

Figure 13: DO8 - Material No. 00C6CB1-1100

5.7.1 Terminals

Module supply

L+	24 VDC
L-	0V

5.7.2 Status LEDs

5.7.2.1 LED „EtherCAT Run“

The LED labelled „EtherCAT Run“ indicates the state of the EtherCAT ASIC.

State	LED, flash code	Explanation
init	Off	Initialising, no data exchange
Pre-Op	Off/green, 1:1	Pre-operational, no data exchange
Safe-Op	Off/green, 5:1	Safe operation, inputs readable
Op	Green, on	Operational, unrestricted data exchange

5.7.2.2 „IO“ LED

State	LED, flash code	Explanation
OK	Off	No error
KS	Red, on	Short-circuited digital output



The output drivers have a thermal fuse to automatically turn off any short-circuited outputs. In case the short circuit prevails, the outputs are allowed to cool down to be turned back on until the thermal fuse blows again.

5.7.2.3 „Power“ LED

The LED labelled "Power" indicates the state of the I/O module's I/O power supply.

State	LED, flash code	Explanation
On	Green, on	24 VDC supply available
Off	Off	24 VDC supply not available



The module is not monitored for low voltage states.

5.7.2.4 „Channel“ LEDs

State	LED, flash code	Explanation
On	Green, on	Output on
Off	Off	Output off



5.7.3 Function

The DO8 module has 8 digital outputs.

5.7.3.1 Variable

Variable	Data type	Explanation
DigitalOutputn	BOOL	Digital output (n=0...7)
Reserved	BOOL	Unused output addresses

5.7.4 Technical data

Digital outputs	8		
max. current	1.0A for each output		
Total current	max. 8A		
Connector I/O / Power	Connector 18-pole		
Controller	ASIC ET1200		
Baud rate	100 Mbit/s		
E-bus port	10-pin system plug in side wall		
Term. module	not required		
Voltage supply	24V DC -20% +25%		
E-bus load	130mA		
Part no.	00C6CB1-1100		
Approvals			

5.8 DO08 Relay NO 24 V

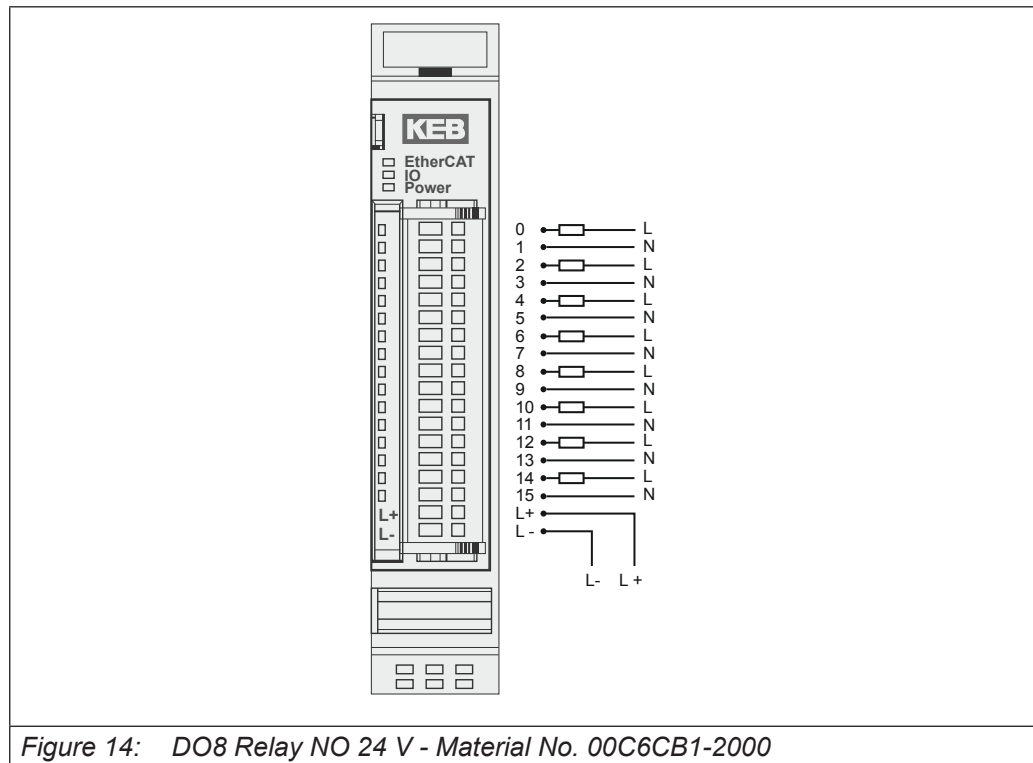

Figure 14: DO08 Relay NO 24 V - Material No. 00C6CB1-2000

5.8.1 Terminals

Module supply

L+	24 VDC
L-	0V

5.8.2 Status LEDs

5.8.2.1 LED „EtherCAT Run“

The LED labelled „EtherCAT Run“ indicates the state of the EtherCAT ASIC.

State	LED, flash code	Explanation
init	Off	Initialising, no data exchange
Pre-Op	Off/green, 1:1	Pre-operational, no data exchange
Safe-Op	Off/green, 5:1	Safe operation, inputs readable
Op	Green, on	Operational, unrestricted data exchange

5.8.2.2 „IO“ LED

The "IO" LED is without function.

5.8.2.3 „Power“ LED

The LED labelled "Power" indicates the state of the I/O module's I/O power supply.

State	LED, flash code	Explanation
On	Green, on	24 VDC supply available
Off	Off	24 VDC supply not available

5.8.2.4 „Channel“ LEDs

State	LED, flash code	Explanation
On	Green, on	Output on
Off	Off	Output off



5.8.3 Function

The module DO8 Relay NO 24 V DC has 8 relay outputs.

5.8.3.1 Variable

Variable	Data type	Explanation
DigitalOutputn	BOOL	Digital output (n=0...7)
Reserved	BOOL	Unused output addresses

5.8.4 Technical data

Digital outputs	8 no contact relay		
max. current (ohmic)	5.0A for each output		
max. current (inductive)	2.0A for each output		
min. permissible load	10mA @ 5 VDC		
Switching cycles mech. (min.)	2 x 10 ⁷		
Switching cycles electr. (min.)	3 x 10 ⁵ (2A/30 VDC)		
Switching voltage	max. 24 VDC/VAC		
Connector I/O / Power	Connector 18-pole		
Controller	ASIC ET1200		
Baud rate	100 Mbit/s		
E-bus port	10-pin system plug in side wall		
Term. module	not required		
Voltage supply	24V DC -20% +25%		
E-bus load	130mA		
Part no.	00C6CB1-2000		
Approvals			

5.9 DO08 Relay NO 230 VAC

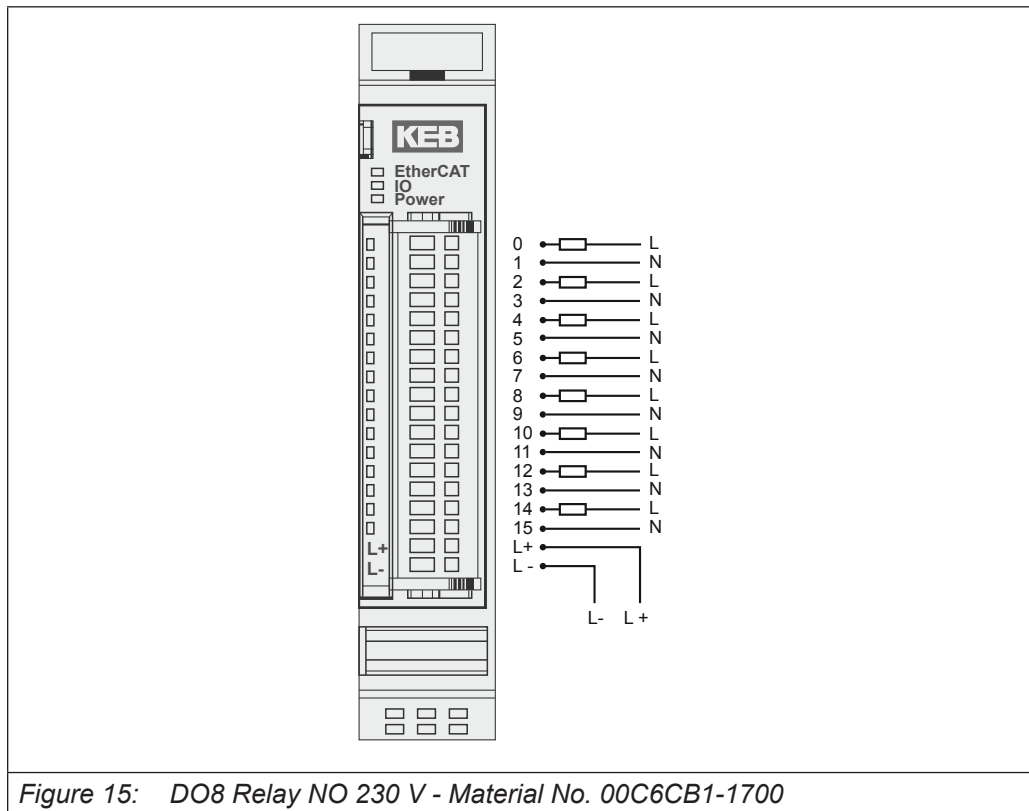

Figure 15: DO8 Relay NO 230 V - Material No. 00C6CB1-1700

5.9.1 Terminals

Module supply

L+	24 VDC
L-	0V

5.9.2 Status LEDs

5.9.2.1 LED „EtherCAT Run“

The LED labelled „EtherCAT Run“ indicates the state of the EtherCAT ASIC.

State	LED, flash code	Explanation
init	Off	Initialising, no data exchange
Pre-Op	Off/green, 1:1	Pre-operational, no data exchange
Safe-Op	Off/green, 5:1	Safe operation, inputs readable
Op	Green, on	Operational, unrestricted data exchange

5.9.2.2 „IO“ LED

The "IO" LED is without function.

5.9.2.3 „Power“ LED

The LED labelled "Power" indicates the state of the I/O module's I/O power supply.

State	LED, flash code	Explanation
On	Green, on	24 VDC supply available
Off	Off	24 VDC supply not available

5.9.2.4 „Channel“ LEDs

State	LED, flash code	Explanation
On	Green, on	Output on
Off	Off	Output off



5.9.3 Function

The module DO8 Relay NO 230 V AC has 8 relay outputs.

5.9.3.1 Variable

Variable	Data type	Explanation
DigitalOutputn	BOOL	Digital output (n=0...7)
Reserved	BOOL	Unused output addresses

5.9.4 Technical data

Digital outputs	8 no contact relay		
max. current (ohmic)	5.0A for each output		
max. current (inductive)	2.0A for each output		
min. permissible load	10mA @ 5 VDC		
Switching cycles mech. (min.)	2 x 10 ⁷		
Switching cycles electr. (min.)	3 x 10 ⁵ (2A/30 VDC)		
Switching voltage	max. 24 VDC/230 VAC		
Connector I/O / Power	Connector 18-pole		
Controller	ASIC ET1200		
Baud rate	100 Mbit/s		
E-bus port	10-pin system plug in side wall		
Term. module	not required		
Voltage supply	24V DC -20% +25%		
E-bus load	130mA		
Part no.	00C6CB1-1700		
Approvals			

6 Counter2

6.1 Counter2

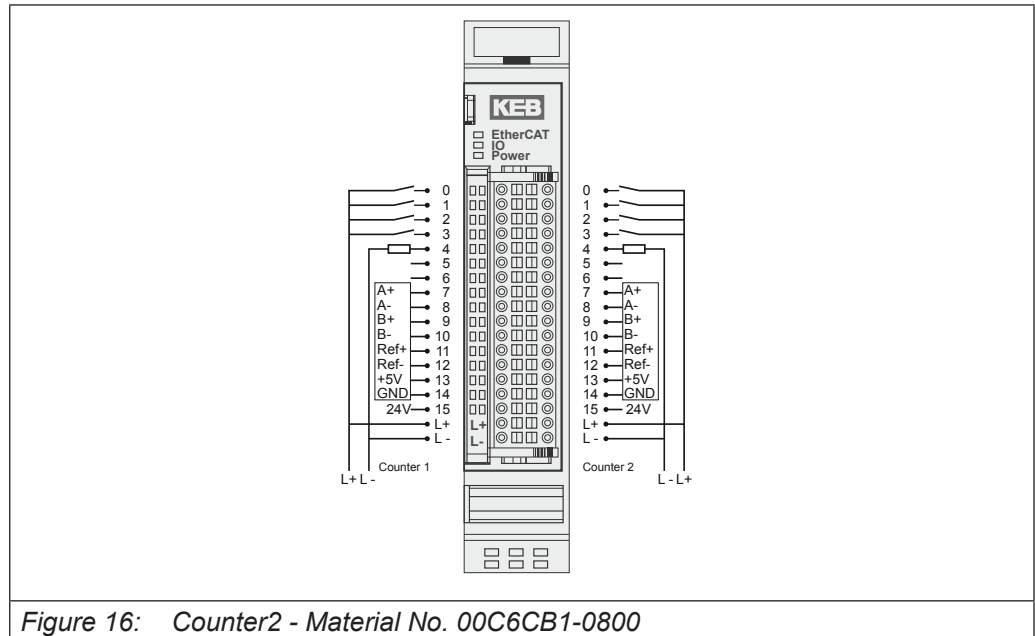

Figure 16: Counter2 - Material No. 00C6CB1-0800

6.1.1 Terminals

Terminal	Signal	Explanation
0...3	In_0...3	Digital inputs
4	Out_0	Digital output
5...6	A_Out	Analog output (only Counter/Posi2)
7...12	A, B, Ref	Incremental encoder signals*
13...14	5V	Encoder supply 5V (0.2A fuse)
15	+24V	Encoder supply +24V (0.2A fuse)
16...17	24V	Module supply

*connect unused encoder signals to +5V

6.1.2 Status LEDs

6.1.2.1 LED „EtherCAT Run“

The LED labelled „EtherCAT Run“ indicates the state of the EtherCAT ASIC.

State	LED, flash code	Explanation
init	Off	Initialising, no data exchange
Pre-Op	Off/green, 1:1	Pre-operational, no data exchange
Safe-Op	Off/green, 5:1	Safe operation, inputs readable
Op	Green, on	Operational, unrestricted data exchange

6.1.2.2 „IO“ LED

State	LED, flash code	Explanation
OK	Green, on	No error
Error	Off	Malfunction of module if E-bus LED = On Inoperative if E-bus LED = Off
	Red, 2 x	Low voltage
	Red, 3 x	Watchdog internal
	Red, 4 x	EtherCat watchdog control
	Red, 7 x	Configuration error (E-Bus in Pre-Op state), number of process data differs from that in the module
Defective	Red, on	Module defective

6.1.2.3 „Power“ LED

The LED labelled "Power" indicates the state of the I/O module's I/O power supply.

State	LED, flash code	Explanation
On	Green, on	24 VDC supply available
Off	Off	24 VDC supply not available

6.1.2.4 Status LEDs of the IOs

The status LEDs of single IOs display the status of single digital I/Os.

Terminal	Voltage supply	LED	Explanation
0...3	24 V	Green	Digital inputs
4	24 V	Green	Digital output
7, 9, 11	5V	Green	Incremental encoder signals A, B, Ref

6.1.3 Function

The module Counter2 has 2 identical channels. Each channel has terminals for 1 encoder and 4 digital inputs and 1 digital output. The Counter / Posi2 module also has an analog output.

There are structured groups of variables for:

1. Controlling and monitoring the entire module:
 - Module control/module status
2. For control and monitoring of counter 1 or 2:
 - Options/controlling/status/error
3. For the counts of counter 1 or 2:
 - Setpoints/actual values
4. For the state of the digital IOs of counter 1 or 2:
 - Digital outputs/digital inputs/input edge-time stamp/output delay
5. For the state of the analog outputs of counter 1 or 2:
 - Optional analog output (function only with module Counter/Posi2)



Principle of control and status:

If a control bit is set (=TRUE), the module will operate the corresponding function due to the rising edge of the bit.

The module indicates the execution of the function by setting the corresponding status bit (=TRUE). When the control bit is reset (=FALSE) the module will also reset the status bit (=FALSE).



The function of counter/posi 1 is described in the following. The data apply as follows for counter/posi 2.

Frame- or DC synchronous operation

Depending on whether Distributed Clocks (DC) are used or not, the module adjusts itself independently on the suitable mode of operation.

The module is preset on Frame synchronous operation. With the receipt of the first DC telegram the module is changed over to DC-synchronous mode and maintains this mode of operation up to the next switching off.

Frame-synchronous

The EtherCAT master sends EtherCAT frames with the output data for the module. With the receipt of such frame the output data are accepted and processed by the module. The module places its input data into the EtherCAT frame, so that the master can receive it.

DC-synchronous

If the module is adjusted to DC-synchronous operation, it produces interrupts according to the rules of the Distributed Clocks DC.

The EtherCAT master sends also here EtherCAT Frames away with the output data for the module. With the receive of such frames the output data of the module are accepted however then processed only if a DC interrupt has occurred. With the DC interrupt the module places its input data into a buffer, from which they are transported with the next EtherCAT Frame to the master.

With this method time-synchronous functions for digital inputs and digital outputs for several modules in an EtherCAT network are possible.

Controlling and monitoring the entire module

The module control occurs with the variables from the group "Module control". The status of the settings is displayed in the variables of the group module status.

Module control

The module has currently no different module global options.

The module indicates error with different "module status" bits. These error bits are stored. They can be reset only then if the fault is not there any more. To reset the error bits set control bit "ResetError" to a rising edge.

6.1.3.1 Variable

Variable	Data type	Explanation
ResetError	BOOL	rising edge -> acknowledges error

6.1.3.2 Module status

The following module status bits are indicated:

Variable	Data type	Explanation
LowSupplyVoltage	BOOL	Low voltage
Watchdog	BOOL	Internal watchdog of module
EtherCAT_Error	BOOL	Configuration error or watchdog control

6.1.3.3 Control/monitoring counter 1

The setting of the functions of the counter is carried out with the variables of the group "Counter 1 options".

The module control is carried out with the variables from the group „Counter 1 controlling“.

The status of the settings is displayed in the variables of the group „Counter 1 status“.



The use of the counter module in a variety of different applications is possible by use of the variables from the groups counter 1 options, controlling and status.

Counter 1 options

The module offers different options for the operation of counter 1. The options are set in the module with the help of the control bit "SetOptions_1" (see also counter 1 controlling) and then valid up to the next setting.

To set up the module choose the options as appropriate and accept by setting control bit "SetOptions_1" to a rising edge.

The module indicates the execution by

„OptionsSet_1=TRUE“. When „SetOptions_1“ becomes FALSE again, the module responds by

„OptionsSet_1=FALSE“. So the module is ready for the next setting process.

Variable	Data type	Value	Explanation
Enable_Compare_1	BOOL	0	Deactivate compare function
		1	Activate compare function
SelectEncoder_1	BOOL	0	A, B, Ref with direction detection
		1	Event counter at A B=0 downwards B=1 upwards
SetResolution_1	BOOL		Only if SelectEncoder = 1 (Event counter)
		0	Rising and falling edges
		1	Only rising edges
ControlOutput_1	BOOL	0	Output_0_0 is a digital output
		1	Output_0_0 is controlled by the compare function.
OnErrorForceOutputsOff_1 (from release 3)	BOOL	0	All digital and analog outputs are updated in case of module errors.
		1	All digital and analog outputs are set to 0 in case of module errors.

Counter 1 controlling

Enabling and disabling of counting and referencing are determined by the state of the control variables.

Set and reset functions are activated by setting of the appropriate variables.

The execution is indicated in the corresponding status variable.

If the control variable is reset, the counter module also resets the corresponding status variable.

Variable	Data type	Value	Explanation
SetOptions_1	BOOL	0/1	Take over Counter 1 options
ResetReferenced_1	BOOL	0/1	Reset of status bit "Referenced_1"
ResetCompared_1	BOOL	0/1	Reset of status bit "Compared_1"
ResetCaptured_1	BOOL	0/1	Reset of status bit "Captured_1"
EnableCounter_1	BOOL	0	Disable counter
		1	Enable counter
EnableReferencing_1	BOOL	0	Disable referencing
		1	Enable referencing
SetCounter_1	BOOL	0/1	Set counter to preset value
SetCompare_1	BOOL	0/1	Set compare value
SetPreset_1	BOOL	0/1	Set preset value register
SetMax_1	BOOL	0/1	Set maximum value time

Counter 1 status

The status variables indicate the status of the counter. This applies

- to the occurrence of events and
- the message about the execution of settings.

Variable	Data type	Explanation
Counting_1	BOOL	Counter is enabled
Referenced_1	BOOL	Reference function was executed Reset by ResetReferenced_1
Clockwise_1	BOOL	Counter counts up
Compared_1	BOOL	Compare function was executed Reset by ResetCompared_1
Captured_1	BOOL	Capture function was executed Reset by ResetCaptured_1
CounterSet_1	BOOL	Counter is set to preset value
CompareSet_1	BOOL	Compare value is set
PresetSet_1	BOOL	Preset value is set
MaxSet_1	BOOL	Maximum value is set
OptionsSet_1	BOOL	Options of counter 1 are set
OutputsOnErrorOff_1	BOOL	The outputs are switched off in case of error. (from release 3)

Counter 1 error

The variables are provided for the indication of error states.

Variable	Data type	Explanation
OutputsForcedOff_1	BOOL	Outputs were set to 0 in case of module errors (from release 3)
Err_Reserved_1_x	BOOL	reserved error bits

Counts of counter 1

Counter 1 setpoints

The counter can be preset with different setpoints. That is done by help of the variable "SetValue_1". After setting the following control bits the contents of "Counter 1 controlling" will be copied in the corresponding register.

Variable	Explanation
SetCounter_1	Copy "SetValue_1" to the current counter value
SetCompare_1	Copy "SetValue_1" to the compare value register
SetPreset_1	Copy "SetValue_1" to the preset value register
SetMax_1	Copy "SetValue_1" to the maximum value register

- The current set values can be read in the variable "SelectedValue" from the current counter value.
- Select the variable "Select_1", which value you want to see in the variable "SelectedValue".

Variable	Explanation
SetCounter_1	Copy "SetValue_1" to the current counter value
SetCompare_1	Copy "SetValue_1" to the compare value register
SetPreset_1	Copy "SetValue_1" to the preset value register
SetMax_1	Copy "SetValue_1" to the maximum value register

Variable	Data type	Explanation
Select_1	USINT	Selection of the value of counter 1, which shall be displayed in the variable "SelectedValue".
		0 no
		1 Compare value (Compare)
		2 Preset value (Preset)
		3 Final value (Max) (Default:2,147,483,647)
		4 Capture value (Capture)
		5 Counter pulses/second
		6 Revolutions per minute
		128 Version info
SetValue_1	UDINT	Set value of counter1 for transfer via a control bit

Counter 1 actual values

These variables display the current counter value and the current preset values. The preset values are displayed multiplexed in the variable "SelectedValue" (Selection by Select_1).

Variable	Data type	Explanation
Counter_1	UDINT	Actual value of counter 1
Select_1	USINT	Selection of the value of counter 1, which shall be displayed in the variable "SelectedValue". (Value of Select_1 read from the module)
		0 no
		1 Compare value (Compare)
		2 Preset value (Preset)
		3 Max value (Max)
		4 Capture value (Capture)
		5 Counter pulses/second
		6 Revolutions per minute
		128 Version info
SetValue_1	UDINT	Selected current value of counter 1

Version Info:

Byte	3	2	1	0
Explanation	Version #	Release	level	Type code
Example	0x2	0x00	0x00	0x53
	2	0	0	S

Digital I/Os

Counter 1 digital inputs

The variables indicate the status of the digital inputs.

Variable	Data type	Explanation
Input_0_0	BOOL	Digital input 0
Input_0_1	BOOL	Digital input 1
Input_0_2	BOOL	Digital input 2
Input_0_3	BOOL	Digital input 3
In_Output_0_0	BOOL	Status of digital output 0 (reads the status)

Counter 1 input edges-time stamp

The variables indicate the time when a state change has taken place at the digital inputs. When the time measurement is started, depends on the operating mode.

Variable	Data type	Explanation
Input_0_0_TS	UINT	Time stamp for digital input 0 (hardware trigger)
Input_0_1_TS	UINT	Time stamp for digital input 1 (software polling)
Input_0_2_TS	UINT	Time stamp for digital input 2 (software polling)
Input_0_3_TS	UINT	Time stamp for digital input 3 (software polling)



The time stamp is measured between frame- or DC interrupts and signal changes on the input in μs . The value of the time stamp becomes to 0xFFFF, when no signal change takes place between two frame- or DC interrupts.

In Frame-synchronous operation:

The time from the last frame-interrupt to the status change of the input is stored in the time stamp and sent in the following frame to the EtherCAT master.

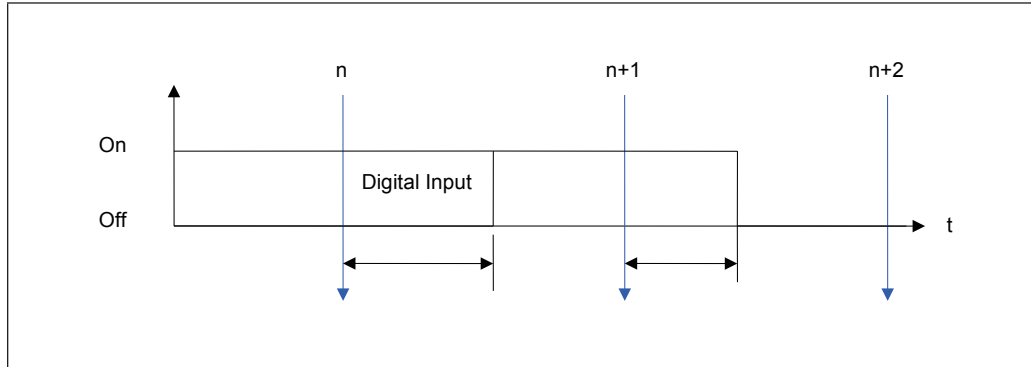

Frame	Digital Input	
	Variable	Time stamp
n+1	TRUE	Time stamp (n)
n+2	FALSE	Time stamp (n+1)

In DC-synchronous operation:

The time from the last DC-interrupt to the status change at the input is stored in the time stamp and sent to the EtherCAT master in the following frame.

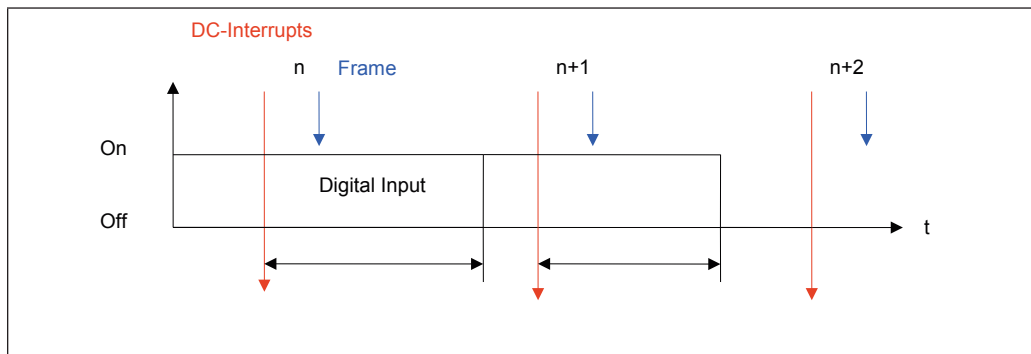

Frame	Digital Input	
	Variable	Time stamp
n+1	TRUE	Time stamp (n)
n+2	FALSE	Time stamp (n+1)

Digital outputs

The variables define the state of the digital outputs.

Variable	Data type	Explanation
Output_0_0	BOOL	Digital output 0

Output delay (in preparation)

This variable determines the time when the output is set.

Variable	Data type	Explanation
Output_0_0_Del	UINT	Output delay in μ s

In Frame-synchronous operation:

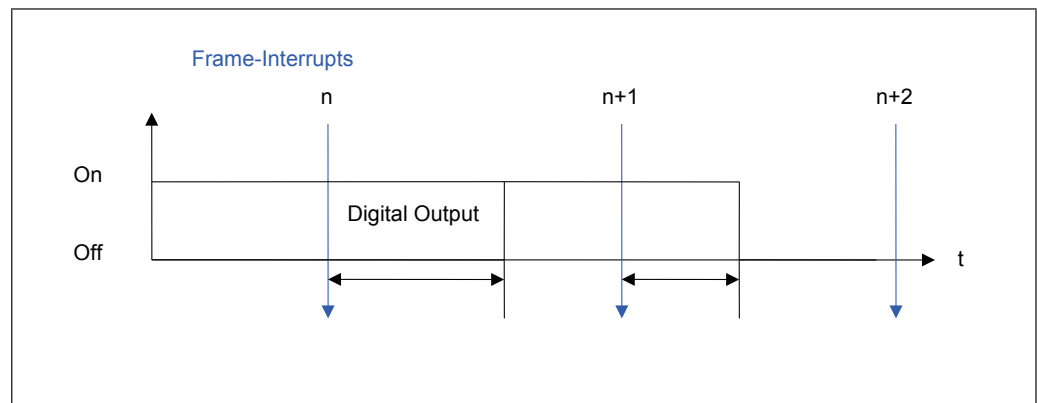

Frame	Digital Output	
	Variable	Output delay
n	TRUE	Output delay (n)
n+1	FALSE	Output delay (n+1)

In DC-synchronous operation:

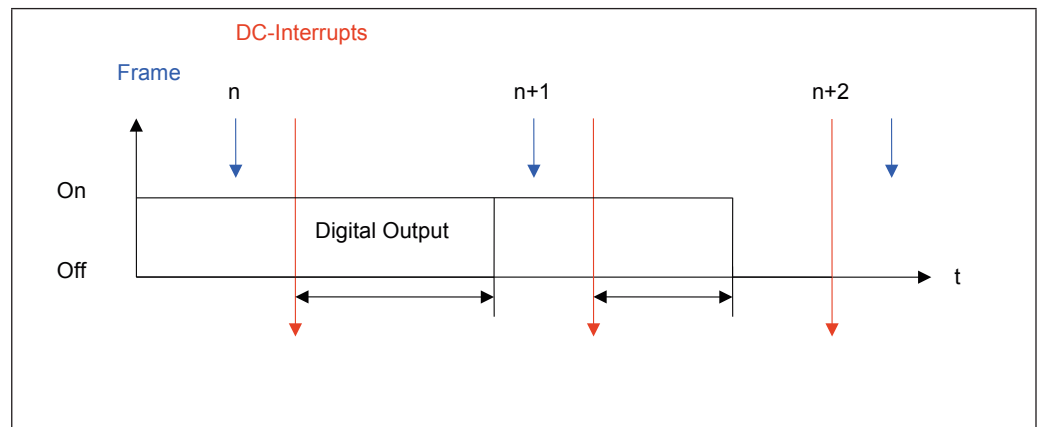

Frame	Digital Ouput	
	Variable	Output delay
n	TRUE	Output delay (n)
n+1	FALSE	Output delay (n+1)

Set counter / clear

Copying the content of "SetValue_1" into the current counter value is executed by a rising edge to "SetCounter_1". The execution is indicated by "CounterSet_1=TRUE".

If "SetCounter_1" is reset to FALSE again, "CounterSet_1" becomes also again FALSE.

```

Term2_SetValue_1:=diCounterValue; (*Write value in the register*)
                                 (* 0 = Clear*)
Term2_SetCounter_1:=TRUE;      (*copy to the counter current value*)
Term2_CounterSet_1;           (*TRUE, if set*)
    
```

Set compare value

Configuration settings in 'Counter 1 Options' are activated by the rising edge of control bit "SetOptions_1". The successful acceptance of the adjustments is confirmed with status bit "OptionsSet_1", such as set comparison value function.

```

var
    bInit_BOOL :=TRUE;
    Step: USINT;
END_VAR
-----
IF bInit THEN
    CASE Step OF
        (*Selecting of the options and setting them by a rising edge v. "Set_Options"*)
        0:  Term2_EnableCounter_1:=TRUE; (*Enable counter*)
            Term2_EnableCom- (*Activate compare function*)
            pare_1:=TRUE;
            Term2_ControlOutput_1:=TRUE; (*Compare function controls output*)
            Term2_SetValue_1:=10000; (*Set value = 10000..*)
            Term2_SetCompare_1:=TRUE; (*..use as compare value*)
            Term2_SetOptions_1:=TRUE; (*Activate selected options*)
            Step:= 1;
        (* Wait for confirmations "OptionsSet" and "CompareSet"*)
    
```

```

1: IF Term2_OptionsSet_1 AND Term2_CompareSet_1 THEN
    Step:=2;
    END_IF
(* Set "Set_Options" and " SetCompare" in the starting position*)
2: Term2_SetOptions_1:=FALSE;
   Term2_SetCompare_1:=FALSE;
   Step:=0;
   bInit:=FALSE;
   END_CASE
END_IF

```

Set preset value register

Copying the contents of "SetValue_1" into the preset value is executed by a rising edge to "SetPreset_1". The execution is displayed with "PresetSet_1=TRUE".

If "SetPreset_1" is reset to FALSE again, "PresetSet_1" becomes also again FALSE.

```

Term2_SetValue_1:=diPresetValue;      (*Write value in the register*)
Term2_SetPreset_1:=TRUE;              (*Copy to the preset value*)
Term2_PresetSet_1;                    (*TRUE, if set*)

```

Set maximum value

Copying the value of "SetValue_1" into the preset value is executed by a rising edge to "SetMax_1". The execution is displayed by „MaxSet_1=TRUE“.

If "SetMax_1" is reset to FALSE again, "MaxSet_1" becomes also again FALSE.

```

Term2_SetValue_1:=diMaxValue;        (*Write value in the register*)
Term2_SetMax_1:=TRUE;                (*Copy to the maximum value*)
Term2_MaxSet_1;                      (*TRUE, if set*)

```

Digital output

The digital output can be controlled optionally by the variable "Output_0_0" or the compare function. The selection is done by the variable „ControlOutput_1“

The current status of the output is read from the module and displayed in "In_Output_0_0".

```

Term2_ControlOutput_1:=FALSE;        (*Term2_Output_0_0 controls output*)
Term2_ControlOutput_1:=TRUE;        (*Compare function controls output*)
Term2_In_Output_0_0;                (*Status of the output*)

```

Operation as A-B-Ref-counter or event counter

The counter can be operated as A, B, Ref-counter with self detection of the direction or as event counter. Selection is done by the variable „SelectEncoder_1“

```

Term2_SelectEncoder_1:=FALSE;        (*A, B, Ref with direction detection*)
Term2_SelectEncoder_1:=TRUE;        (*Event counter at A*)
                                     (*B=FALSE:down, B=TRUE:up*)

```

Single and multiple counting

This option is valid in the event counter mode only

The counter can count edges (all rising and falling) or pulses (only rising edges).

The selection is done by the variable „SetResolution_1“

Term2_SetResolution_1:=FALSE; (*all edges*)

Term2_SetResolution_1:=TRUE; (*Pulses*)

Referencing

The counter can be set to a preset value when a pulse occurs at the Ref input. The preset value can be 0, but also any other 32-bit value.

Task:

An encoder with 500 pulses provides 2000 increments per revolution in the all edges mode.

Every Ref pulse shall set the counter to the preset value 2000. It shall be counted down to 0 within 1 encoder revolution.

(The counting direction is determined by the direction of the incremental encoder).

PROGRAM Referencing

```
var
    bInIt: BOOL := TRUE;
    StepInIt: USINT;
    bInItReady: BOOL;
    Step: USINT;
END_VAR
```

(*1. Initializing: Enabling of the counter and setting of the prese value*)

IF bInIt THEN

 CASE StepInIt OF

(*Selecting of the options and setting them by a rising edge v. "Set_Options"*)

 0: Term2_EnableCounter_1:=TRUE;

 Term2_SetValue_1:=2000;

 Term2_SetPreset_1:=TRUE;

 Term2_SetOptions_1:=TRUE;

 StepInIt:=1;

(* Wait for confirmations „OptionsSet“ and „PresetSet“*)

```

1: IF Term2_OptionsSet_1 AND Term2_PresetSet_1 THEN
    StepInit:=2;
    END_IF
(* Reset "Set_Options" and "Set_Preset" into the start position*)

2: Term2_SetOptions_1:=FALSE;
   Term2_SetPreset_1:=FALSE;
   StepInit:=0;
   bInit:=FALSE;
   bInitReady:=TRUE;
   END_CASE
END_IF

(*2. Controlling of the referencing*)
IF bInitReady THEN
    CASE Step OF
        (*Switch on the referencing mode*)
        1:          IF Term2_Referenced_1 THEN
                                Step:=2;
                                END_IF

                                (*Reset of the referencing message*)
        2:          Term2_ResetReferenced_1:=TRUE;
                                Step:=3;
        3:          IF NOT Term2_Referenced_1 THEN
                                (* Reset "ResetReferenced_1 into the start position*)
                                Term2_ResetReferenced_1:=FALSE;
                                (*Switch off the referencing mode*)

                                Term2_EnableReferencing_1:=FALSE;
                                Step:=0;  (*Next revolution the same procedure*)
                                END_IF
                                END_CASE
END_IF

```

Capture

A falling edge at the digital input 1 can be used as trigger in order to save the current counter value (capture).

You get a message in the status bit "Captured_1" that a capture event has appeared. You have to reset "Captured_1" by "ResetCaptured_1" that the next capture event can be indicated.

```
Term2_Input_0_1;      (*Status of input 1*)
Term2_Select_1:=4;   (*Display capture value in Term2_SelectedValue_1*)
Term2_Selected_1;    (* =4, if capture value in Term2_SelectedValue_1*)
Term2_SelectedValue_1; (* Here you can read the capture value*)
Term2_Captured_1;    (* A capture event has appeared*)
Term2_ResetCaptured_1; (* Reset of Term2_Captured_1*)
```

Digital inputs (Input_0_x)



The status of the digital inputs is indicated in the variables "Input_0_x".

Permanent auxiliary function:

The current counter value is saved in the capture register when a falling edge appears at input_0_1.

```
Term2_Input_0_0;      (*Status of input 0*)
Term2_Input_0_1;      (*Status of input 1*)
Term2_Input_0_2;      (*Status of input 2*)
Term2_Input_0_3;      (*Status of input 3*)
```

6.1.4 Technical data

Counter2 5V			
Encoder*	2 x incremental encoder signal A, B, Ref		
	*Encoder signals that are not used must be connected to +5 V.		
Encoder type	RS422, 5V, 24VDC		
Count frequency	RS422:	200kHz	
	24V:	200kHz	
Digital inputs	8		
Input delay	1ms		
Signal level	Off:	-3 ... 5V	
	On:	15V ... 30V (EN 61131-3, Type1)	
Digital outputs	2		
max. current	2A for each output		
Fieldbus	EtherCAT 100 Mbit/s		
WxHxD	25x120x90 mm		
Installation	35mm DIN mounting rail		
Controller	ASIC ET1200		
E-bus port	10-pin system plug in side wall		
Term. module	not required		
E-bus load	300mA		
Voltage supply	Power24V DC -20% +25%		
Connector I/O / Power	Connector 36-pole		
Potential separation	modules electrically insulated from one another and from the bus		
Storage temperature	-25 °C...+70 °C		
Operating temperature	0°C...+55°C		
Relative humidity	5%...95% without condensation		
Degree of protection	IP20		
Interference immunity	Zone B		
Part no.	00C6CB1-0800		
Approvals		 LISTED Prog. Cntrl. E479848	 EtherCAT® Conformance tested

7 Counter/Posi2

7.1 Counter/Posi2

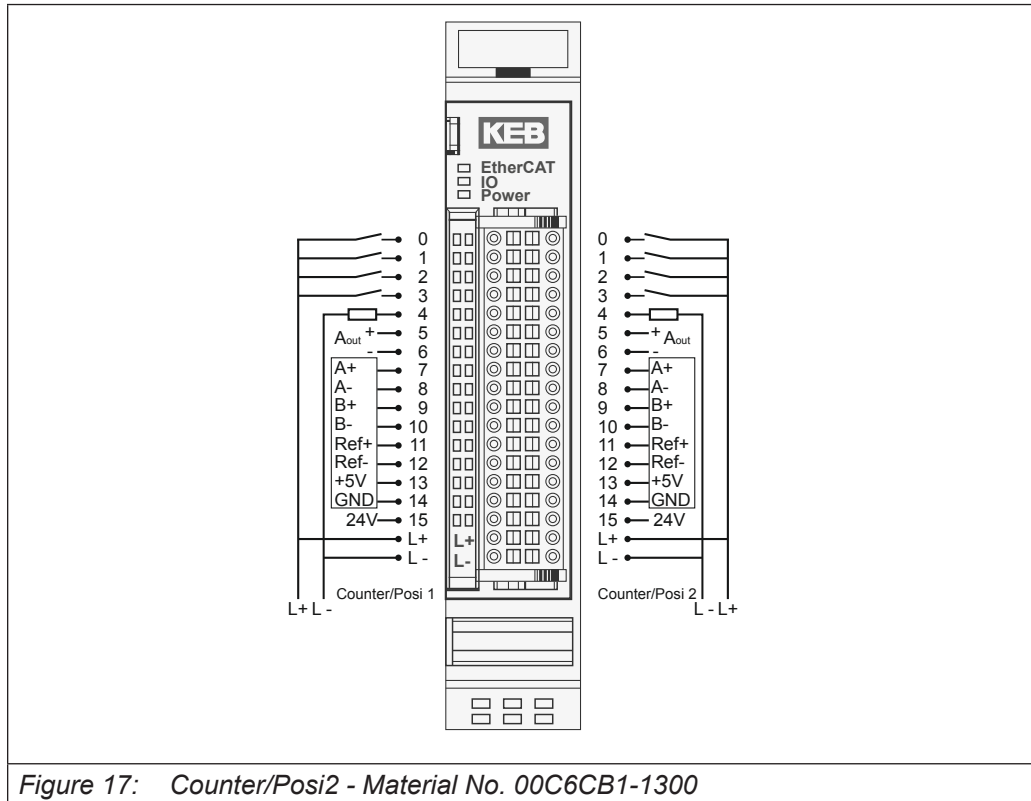

Figure 17: Counter/Posi2 - Material No. 00C6CB1-1300

7.1.1 Terminals

Terminal	Signal	Explanation
0...3	In_0...3	Digital inputs
4	Out_0	Digital output
5...6	A_Out	Analog output (only Counter/Posi2)
7...12	A, B, Ref	Incremental encoder signals*
13...14	5V	Encoder supply 5V (0.2A fuse)
15	+24V	Encoder supply +24V (0.2A fuse)
16...17	24V	Module supply

*connect unused encoder signals to +5V

7.1.2 Status LEDs

7.1.2.1 LED „EtherCAT Run“

The LED labelled „EtherCAT Run“ indicates the state of the EtherCAT ASIC.

State	LED, flash code	Explanation
init	Off	Initialising, no data exchange
Pre-Op	Off/green, 1:1	Pre-operational, no data exchange
Safe-Op	Off/green, 5:1	Safe operation, inputs readable
Op	Green, on	Operational, unrestricted data exchange

7.1.2.2 „IO“ LED

State	LED, flash code	Explanation
OK	Green, on	No error
Error	Off	Malfunction of module if E-bus LED = On Inoperative if E-bus LED = Off
	Red, 2 x	Low voltage
	Red, 3 x	Watchdog internal
	Red, 4 x	EtherCat watchdog control
	Red, 7 x	Configuration error (E-Bus in Pre-Op state), number of process data different than in the module
Defective	Red, on	Module defective

7.1.2.3 „Power“ LED

The LED labelled "Power" indicates the state of the I/O module's I/O power supply.

State	LED, flash code	Explanation
On	Green, on	24 VDC supply available
Off	Off	24 VDC supply not available

7.1.2.4 Status LEDs of the IOs

The status LEDs of single IOs display the status of single digital I/Os.

Terminal	Voltage supply	LED	Explanation
0...3	24 V	Green	Digital inputs
4	24 V	Green	Digital output
7, 9, 11	5V	Green	Incremental encoder signals A, B, Ref

7.1.3 Function

The module Counter2 has 2 identical channels. Each channel has terminals for 1 encoder and 4 digital inputs and 1 digital output. The Counter / Posi2 module also has an analog output.

There are structured groups of variables for.

1. Controlling and monitoring the entire module:
 - Module control/module status
2. For control and monitoring of counter 1 or 2:
 - Options/controlling/status/error
3. For the counts of counter 1 or 2:
 - Setpoints/actual values
4. For the state of the digital IOs of counter 1 or 2:
 - Digital outputs/digital inputs/input edge-time stamp/output delay
5. For the state of the analog outputs of counter 1 or 2:
 - Optional analog output (function only with module Counter/Posi2)

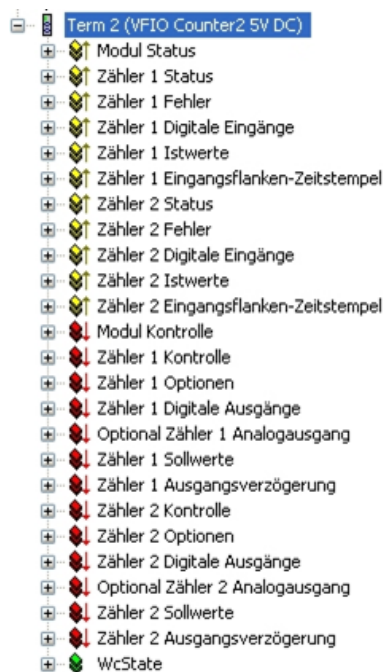

Principle of control and status:

If a control bit is set (=TRUE), the module will operate the corresponding function due to the rising edge of the bit.

The module indicates the execution of the function by setting the corresponding status bit (=TRUE). When the control bit is reset (=FALSE) the module will also reset the status bit (=FALSE).



The function of counter/posi 1 is described in the following. The data apply as follows for counter/posi 2.

Frame- or DC synchronous operation

Depending on whether Distributed Clocks (DC) are used or not, the module adjusts itself independently on the suitable mode of operation.

The module is preset on Frame synchronous operation. With the receipt of the first DC telegram the module is changed over to DC-synchronous mode and maintains this mode of operation up to the next switching off.

Frame-synchronous

The EtherCAT master sends EtherCAT frames with the output data for the module. With the receipt of such frame the output data are accepted and processed by the module. The module places its input data into the EtherCAT frame, so that the master can receive it.

DC-synchronous

If the module is adjusted to DC-synchronous operation, it produces interrupts according to the rules of the Distributed Clocks DC.

The EtherCAT master sends also here EtherCAT Frames away with the output data for the module. With the receive of such frames the output data of the module are accepted however then processed only if a DC interrupt has occurred. With the DC interrupt the module places its input data into a buffer, from which they are transported with the next EtherCAT Frame to the master.

With this method time-synchronous functions for digital inputs and digital outputs for several modules in an EtherCAT network are possible.

Controlling and monitoring the entire module

The module control occurs with the variables from the group "Module control". The status of the settings is displayed in the variables of the group module status.

Module control

The module has currently no different module global options.

The module indicates error with different "module status" bits. These error bits are stored. They can be reset only then if the fault is not there any more. To reset the error bits set control bit "ResetError" to a rising edge.

7.1.3.1 Variable

Variable	Data type	Explanation
ResetError	BOOL	rising edge -> acknowledges error

7.1.3.2 Module status

The following module status bits are indicated:

Variable	Data type	Explanation
LowSupplyVoltage	BOOL	Low voltage
Watchdog	BOOL	Internal watchdog of module
EtherCAT_Error	BOOL	Configuration error or watchdog control

7.1.3.3 Control/monitoring counter 1

The setting of the functions of the counter is carried out with the variables of the group "Counter 1 options".

The module control is carried out with the variables from the group „Counter 1 controlling“.

The status of the settings is displayed in the variables of the group „Counter 1 status“.



The use of the counter module in a variety of different applications is possible by use of the variables from the groups counter 1 options, controlling and status.

Counter 1 options

The module offers different options for the operation of counter 1. The options are set in the module with the help of the control bit "SetOptions_1" (see also counter 1 controlling) and then valid up to the next setting.

To set up the module choose the options as appropriate and accept by setting control bit "SetOptions_1" to a rising edge.

The module indicates the execution by

„OptionsSet_1=TRUE“. When „SetOptions_1“ becomes FALSE again, the module responds by

„OptionsSet_1=FALSE“. So the module is ready for the next setting process.

Variable	Data type	Value	Explanation
Enable_Compare_1	BOOL	0	Deactivate compare function
		1	Activate compare function
SelectEncoder_1	BOOL	0	A, B, Ref with direction detection
		1	Event counter at A B=0 downwards B=1 upwards
SetResolution_1	BOOL		Only if SelectEncoder = 1 (Event counter)
		0	Rising and falling edges
		1	Only rising edges
ControlOutput_1	BOOL	0	Output_0_0 is a digital output
		1	Output_0_0 is controlled by the compare function.
OnErrorForceOutputsOff_1 (from release 3)	BOOL	0	All digital and analog outputs are updated in case of module errors.
		1	All digital and analog outputs are set to 0 in case of module errors.

Counter 1 controlling

Enabling and disabling of counting and referencing are determined by the state of the control variables.

Set and reset functions are activated by setting of the appropriate variables.

The execution is indicated in the corresponding status variable.

If the control variable is reset, the counter module also resets the corresponding status variable.

Variable	Data type	Value	Explanation
SetOptions_1	BOOL	0/1	Take over Counter 1 options
ResetReferenced_1	BOOL	0/1	Reset of status bit "Referenced_1"
ResetCompared_1	BOOL	0/1	Reset of status bit "Compared_1"
ResetCaptured_1	BOOL	0/1	Reset of status bit "Captured_1"
EnableCounter_1	BOOL	0	Disable counter
		1	Enable counter
EnableReferencing_1	BOOL	0	Disable referencing
		1	Enable referencing
SetCounter_1	BOOL	0/1	Set counter to preset value
SetCompare_1	BOOL	0/1	Set compare value
SetPreset_1	BOOL	0/1	Set preset value register
SetMax_1	BOOL	0/1	Set maximum value time

Counter 1 status

The status variables indicate the status of the counter. This applies

- to the occurrence of events and
- the message about the execution of settings.

Variable	Data type	Explanation
Counting_1	BOOL	Counter is enabled
Referenced_1	BOOL	Reference function was executed, Reset by ResetReferenced_1
Clockwise_1	BOOL	Counter counts up
Compared_1	BOOL	Compare function was executed Reset by ResetCompared_1
Captured_1	BOOL	Capture function was executed Reset by ResetCaptured_1
CounterSet_1	BOOL	Counter is set to preset value
CompareSet_1	BOOL	Compare value is set
PresetSet_1	BOOL	Preset value is set
MaxSet_1	BOOL	Maximum value is set
OptionsSet_1	BOOL	Options of counter 1 are set
OutputsOnErrorOff_1	BOOL	The outputs are switched off in case of error. (from release 3)

Counter 1 error

The variables are provided for the indication of error states.

Variable	Data type	Explanation
OutputsForcedOff_1	BOOL	Outputs were set to 0 in case of module errors (from release 3)
Err_Reserved_1_x	BOOL	reserved error bits

Counts of counter 1

Counter 1 setpoints

The counter can be preset with different set values. That is done by help of the variable "SetValue_1". After setting the following control bits the contents of "Counter 1 controlling" will be copied in the corresponding register.

Variable	Explanation
SetCounter_1	Copy "SetValue_1" to the current counter value
SetCompare_1	Copy "SetValue_1" to the compare value register
SetPreset_1	Copy "SetValue_1" to the preset value register
SetMax_1	Copy "SetValue_1" to the maximum value register

- The current set values can be read in the variable "SelectedValue" from the current counter value.
- Select the variable "Select_1", which value you want to see in the variable "SelectedValue".

Variable	Explanation
SetCounter_1	Copy "SetValue_1" to the current counter value
SetCompare_1	Copy "SetValue_1" to the compare value register
SetPreset_1	Copy "SetValue_1" to the preset value register
SetMax_1	Copy "SetValue_1" to the maximum value register

Variable	Data type	Explanation
Select_1	USINT	Selection of the value of counter 1, which shall be displayed in the variable "SelectedValue".
		0 no
		1 Compare value (Compare)
		2 Preset value (Preset)
		3 Final value (Max) (Default:2,147,483,647)
		4 Capture value (Capture)
		5 Counter pulses/second
		6 Revolutions per minute
128 Version info		
SetValue_1	UDINT	Sollwert von Zähler1 zur Übernahme mit Hilfe eines Steuerbits

Counter 1 actual values

These variables display the current counter value and the current preset values. The preset values are

displayed multiplexed in the variable "SelectedValue" (Selection by Select_1).

Variable	Data type	Explanation
Counter_1	UDINT	Actual value of counter 1
Select_1	USINT	Selection of the value of counter 1, which shall be displayed in the variable "SelectedValue". (Value of Select_1 read from the module)
		0 no
		1 Compare value (Compare)
		2 Preset value (Preset)
		3 Max value (Max)
		4 Capture value (Capture)
		5 Counter pulses/second
		6 Revolutions per minute
128 Version info		
SetValue_1	UDINT	Selected current value of counter 1

Version Info:

Byte	3	2	1	0
Explanation	Version #	Release	level	Type code
Example	0x2	0x00	0x00	0x53
	2	0	0	S

Digital I/Os

Counter 1 digital inputs

The variables indicate the status of the digital inputs.

Variable	Data type	Explanation
Input_0_0	BOOL	Digital input 0
Input_0_1	BOOL	Digital input 1
Input_0_2	BOOL	Digital input 2
Input_0_3	BOOL	Digital input 3
In_Output_0_0	BOOL	Status of digital output 0 (reads the status)

Counter 1 input edges-time stamp

The variables indicate the time when a state change has taken place at the digital inputs. When the time measurement is started, depends on the operating mode.

Variable	Data type	Explanation
Input_0_0_TS	UINT	Time stamp for digital input 0 (hardware trigger)
Input_0_1_TS	UINT	Time stamp for digital input 1 (software polling)
Input_0_2_TS	UINT	Time stamp for digital input 2 (software polling)
Input_0_3_TS	UINT	Time stamp for digital input 3 (software polling)



The time stamp is measured between frame- or DC interrupts and signal changes on the input in μs . The value of the time stamp becomes to 0xFFFF, when no signal change takes place between two frame- or DC interrupts.

In Frame-synchronous operation:

The time from the last frame-interrupt to the status change of the input is stored in the time stamp and sent in the following frame to the EtherCAT master.

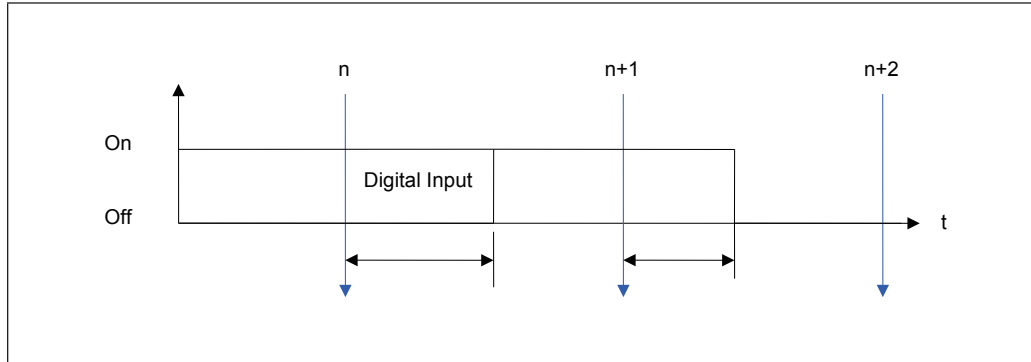

Frame	Digital Input Variable	Time stamp
n+1	TRUE	Time stamp (n)
n+2	FALSE	Time stamp (n+1)

In DC-synchronous operation:

The time from the last DC-interrupt to the status change at the input is stored in the time stamp and sent to the EtherCAT master in the following frame.

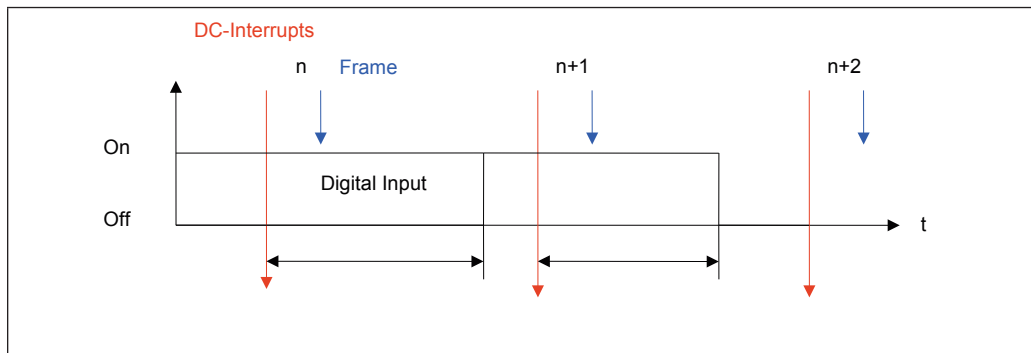

Frame	Digital Input Variable	Time stamp
n+1	TRUE	Time stamp (n)
n+2	FALSE	Time stamp (n+1)

Digital outputs

The variables define the state of the digital outputs.

Variable	Data type	Explanation
Output_0_0	BOOL	Digital output 0

Output delay (in preparation)

This variable determines the time when the output is set.

Variable	Data type	Explanation
Output_0_0_Del	UINT	Output delay in μ s

In Frame-synchronous operation:

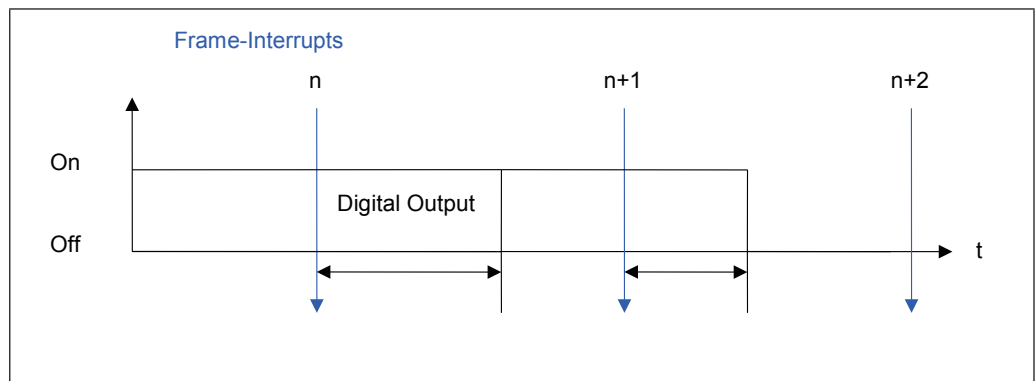

Frame	Digital Output	
	Variable	Output delay
n	TRUE	Output delay (n)
n+1	FALSE	Output delay (n+1)

In DC-synchronous operation:

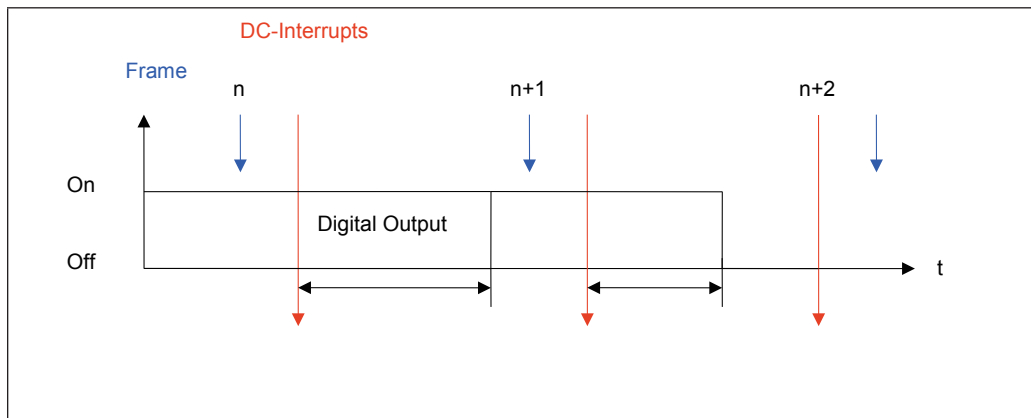

Frame	Digital Output	
	Variable	Output delay
n	TRUE	Output delay (n)
n+1	FALSE	Output delay (n+1)

Analog outputs

The variables determine the voltage values at the analog outputs.

Variable	Data type	Explanation
AnalogOutput_1	UINT	Analog output 1

Voltage [V]	Value hexadecimal	Value decimal
-10	0x8000	-32768
-5	0xC000	-16384
0	0x0	0
5	0x3FFF	16384
10	0x7FFF	32767

Examples

Enable counter

The counter is active, when the variable "EnableCounter_1" is TRUE.

```
Term2_EnableCounter_1:=TRUE;      (*Release of the counter*)
(*Release of the counter*)        (*TRUE, if counter is enabled*)
Term2_Clockwise_1;                (*Count direction, TRUE, when up*)
```

Set counter / clear

Copying the content of "SetValue_1" into the current counter value is executed by a rising edge to "SetCounter_1". The execution is indicated by "CounterSet_1=TRUE".

If "SetCounter_1" is reset to FALSE again, "CounterSet_1" becomes also again FALSE.

```
Term2_SetValue_1:=diCounterValue; (*Write value in the register*)
(* 0 = Clear*)
Term2_SetCounter_1:=TRUE;          (*copy to the counter current value*)
Term2_CounterSet_1;                (*TRUE, if set*)
```

Set compare value

Configuration settings in 'Counter 1 Options' are activated by the rising edge of control bit "SetOptions_1". The successful acceptance of the adjustments is confirmed with status bit "OptionsSet_1", such as set comparison value function.

```
var
    blnit_BOOL :=TRUE;
    Step: USINT;
END_VAR
-----
IF blnit THEN
    CASE Step OF
(*Selecting of the options and setting them by a rising edge v. "Set_Options"*)
        0:  Term2_EnableCounter_1:=TRUE; (*Enable counter*)
            Term2_EnableCompare_1:=TRUE; (*Activate compare function*)
            Term2_ControlOutput_1:=TRUE; (*Compare function controls output*)
            Term2_SetValue_1:=10000; (*Set value = 10000..*)
            Term2_SetCompare_1:=TRUE; (*..use as compare value*)
            Term2_SetOptions_1:=TRUE; (*Activate selected options*)
            Step:= 1;
(* Wait for confirmations "OptionsSet" and "CompareSet"*)
```

```

1: IF Term2_OptionsSet_1 AND Term2_CompareSet_1 THEN
    Step:=2;
    END_IF
(* Set "Set_Options" and " SetCompare" in the starting position*)
2: Term2_SetOptions_1:=FALSE;
   Term2_SetCompare_1:=FALSE;
   Step:=0;
   bInit:=FALSE;
   END_CASE
END_IF

```

Set preset value register

Copying the contents of "SetValue_1" into the preset value is executed by a rising edge to "SetPreset_1". The execution is displayed with "PresetSet_1=TRUE".

If "SetPreset_1" is reset to FALSE again, "PresetSet_1" becomes also again FALSE.

```

Term2_SetValue_1:=diPresetValue;      (*Write value in the register*)
Term2_SetPreset_1:=TRUE;               (*Copy to the preset value*)
Term2_PresetSet_1;                     (*TRUE, if set*)

```

Set maximum value

Copying the value of "SetValue_1" into the preset value is executed by a rising edge to "SetMax_1". The execution is displayed by „MaxSet_1=TRUE“.

If "SetMax_1" is reset to FALSE again, "MaxSet_1" becomes also again FALSE.

```

Term2_SetValue_1:=diMaxValue;         (*Write value in the register*)
Term2_SetMax_1:=TRUE;                 (*Copy to the maximum value*)
Term2_MaxSet_1;                       (*TRUE, if set*)

```

Digital output

The digital output can be controlled optionally by the variable "Output_0_0" or the compare function. The selection is done by the variable „ControlOutput_1“

The current status of the output is read from the module and displayed in "In_Output_0_0".

```

Term2_ControlOutput_1:=FALSE;        (*Term2_Output_0_0 controls output*)
Term2_ControlOutput_1:=TRUE;         (*Compare function controls output*)
Term2_In_Output_0_0;                 (*Status of the output*)

```

Operation as A-B-Ref-counter or event counter

The counter can be operated as A, B, Ref-counter with self detection of the direction or as event counter. Selection is done by the variable „SelectEncoder_1“

```

Term2_SelectEncoder_1:=FALSE;        (*A, B, Ref with direction detection*)
Term2_SelectEncoder_1:=TRUE;         (*Event counter at A*)
                                      (*B=FALSE:down, B=TRUE:up*)

```

Single and multiple counting

This option is valid in the event counter mode only

The counter can count edges (all rising and falling) or pulses (only rising edges).

The selection is done by the variable „SetResolution_1“

Term2_SetResolution_1:=FALSE; (*all edges*)

Term2_SetResolution_1:=TRUE; (*Pulses*)

Referencing

The counter can be set to a preset value when a pulse occurs at the Ref input. The preset value can be 0, but also any other 32-bit value.

Task:

An encoder with 500 pulses provides 2000 increments per revolution in the all edges mode.

Every Ref pulse shall set the counter to the preset value 2000. It shall be counted down to 0 within 1 encoder revolution.

(The counting direction is determined by the direction of the incremental encoder).

PROGRAM Referencing

```
var
    bInIt: BOOL := TRUE;
    StepInIt: USINT;
    bInItReady: BOOL;
    Step: USINT;
END_VAR
```

(*1. Initializing: Enabling of the counter and setting of the prese value*)

```
IF bInIt THEN
    CASE StepInIt OF
    (*Selecting of the options and setting them by a rising edge v. "Set_Options"*)
    0: Term2_EnableCounter_1:=TRUE;
        Term2_SetValue_1:=2000;
        Term2_SetPreset_1:=TRUE;
        Term2_SetOptions_1:=TRUE;
        StepInIt:=1;
    (* Wait for confirmations „OptionsSet“ and „PresetSet“*)
    1: IF Term2_OptionsSet_1 AND Term2_PresetSet_1 THEN
        StepInIt:=2;
    END_IF
    (* Reset "Set_Options" and "Set_Preset" into the start position*)
```

```

2: Term2_SetOptions_1:=FALSE;
   Term2_SetPreset_1:=FALSE;
   StepInit:=0;
   bInit:=FALSE;
   bInitReady:=TRUE;
END_CASE
END_IF

(*2. Controlling of the referencing*)
IF bInitReady THEN
  CASE Step OF
    (*Switch on the referencing mode*)
    1:      IF Term2_Referenced_1 THEN
              Step:=2;
            END_IF

    (*Reset of the referencing message*)
    2:      Term2_ResetReferenced_1:=TRUE;
            Step:=3;
    3:      IF NOT Term2_Referenced_1 THEN
    (* Reset "ResetReferenced_1 into the start position*)
            Term2_ResetReferenced_1:=FALSE;
    (*Switch off the referencing mode*)

            Term2_EnableReferencing_1:=FALSE;
            Step:=0;  (*Next revolution the same procedure*)
            END_IF
          END_CASE
END_IF

```

Capture

A falling edge at the digital input 1 can be used as trigger in order to save the current counter value (capture).

You get a message in the status bit "Captured_1" that a capture event has appeared. You have to reset "Captured_1" by "ResetCaptured_1" that the next capture event can be indicated.

```

Term2_Input_0_1;      (*Status of input 1*)
Term2_Select_1:=4;    (*Display capture value in Term2_SelectedValue_1*)
Term2_Selected_1;     (* =4, if capture value in Term2_SelectedValue_1*)
Term2_SelectedValue_1; (* Here you can read the capture value*)
Term2_Captured_1;     (* A capture event has appeared*)
Term2_ResetCaptured_1; (* Rücksetzen von Term2_Captured_1*)

```

Digital inputs (Input_0_x)

The status of the digital inputs is indicated in the variables "Input_0_x".

Permanent auxiliary function:

The current counter value is saved in the capture register when a falling edge appears at input_0_1.

Term2_Input_0_0; (*Status of input 0*)

Term2_Input_0_1; (*Status of input 1*)

Term2_Input_0_2; (*Status of input 2*)

Term2_Input_0_3; (*Status of input 3*)

Analog outputs (only with Counter/Posi2 5V)



The output values for the analog outputs are written to the variables „AnalogOutput_x“.

Term2_AnalogOutput_1:= 16#7FFF; (* output of +10V to analog output1*)

Term2_AnalogOutput_2:= 16#8000; (* output of -10V to analog output2*)

Output values: See analog outputs (only with Counter/Posi2 5V).

7.1.4 Technical data

Counter/Posi2 5V			
Encoder*	2 x incremental encoder signals A, B, Ref		
	*Encoder signals that are not used must be connected to +5 V.		
Encoder type	RS422, 5V, 24VDC		
Count frequency	RS422:	200kHz	
	24V:	200kHz	
Digital inputs	8		
Input delay	1ms		
Signal level	Off:	-3 ... 5V	
	On:	15V ... 30V (EN 61131-3, Type1)	
Digital outputs	2		
max. current	2A for each output		
Analog outputs	2		
Voltage supply	-10V to +10V		
Resolution	12 Bit		
Fieldbus	EtherCAT 100 Mbit/s		
WxHxD	25x120x90 mm		
Installation	35mm DIN mounting rail		
Controller	ASIC ET1200		
E-bus port	10-pin system plug in side wall		
Term. module	not required		
E-bus load	300mA		
Voltage supply	Power24V DC -20% +25%		
Connector I/O / Power	Connector 36-pole		
Potential separation	modules electrically insulated from one another and from the bus		
Storage temperature	-25 °C...+70 °C		
Operating temperature	0°C...+55°C		
Relative humidity	5% to 95% without condensation		
Degree of protection	IP20		
Interference immunity	Zone B		
Part no.	00C6CB1-1300		
Approvals			

8 Mixed Module

8.1 MIX02

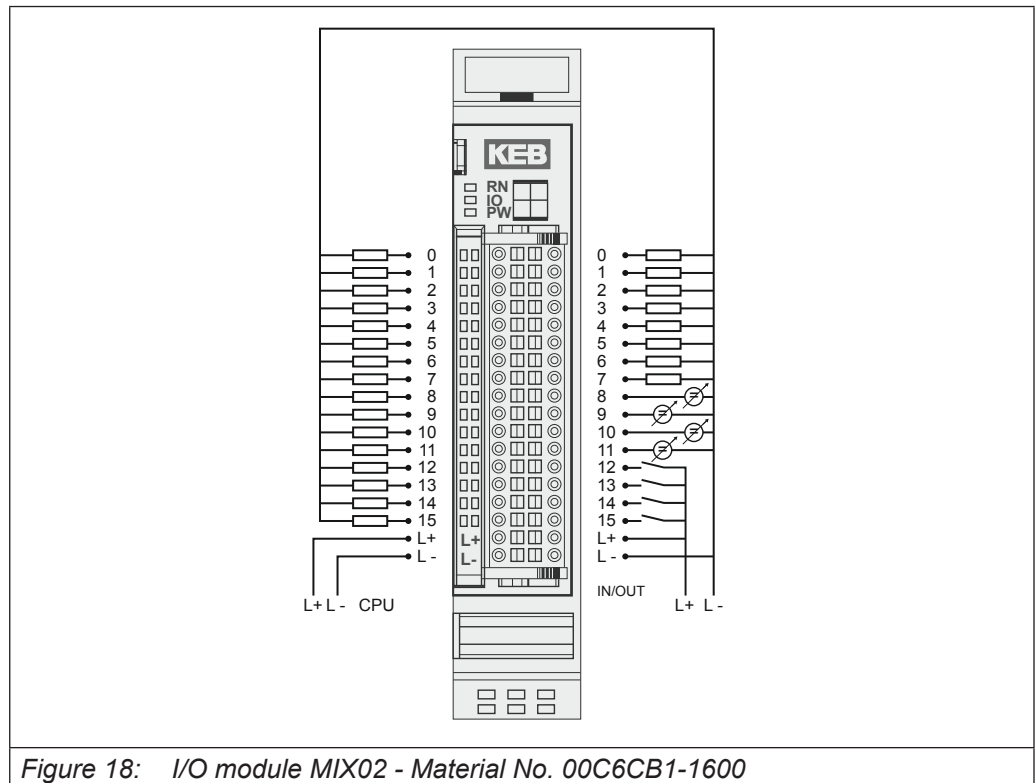

Figure 18: I/O module MIX02 - Material No. 00C6CB1-1600

8.1.1 Terminals

I/O connection 36-pole, male

Site	Terminal	Signal	Explanation			
left	0...15	DO8...DO23	Digital outputs 8...23			
	16, 17	+24VDC, 0V	Module supply CPU			
	0...7	DO0...DO7	Digital outputs 1...7			
	8...11	AI0...AI3, DI0...DI3	Analog inputs (can also be used as DI)			
		12	DI4	Digital input DI		
	13	DI5	C_Clock	DI	Counter clock input (pos. edge)	
	14	DI6	C_Dir	DI	Counting Di- rection	FALSE: up TRUE: down
	15	DI7	C_Clear	DI	Clear counter (pos. edge)	
	16, 17	+24VDC, 0V			I/O supply	

RS485 connection

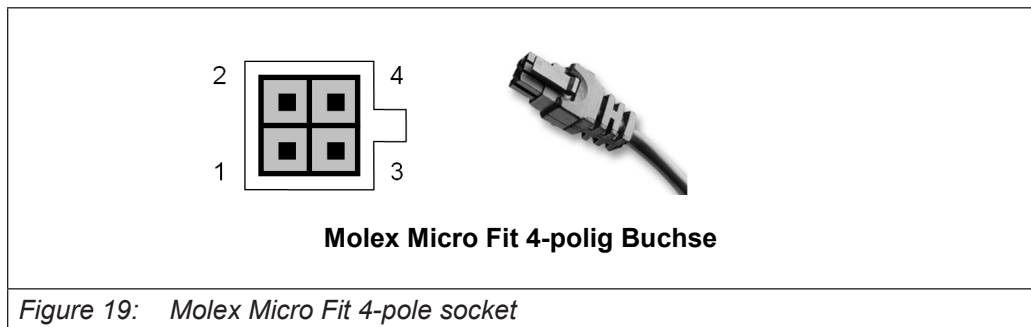

Pin	Signal	Explanation
1	DGND	Data ground potential (reference potential to TxD/RxD)
2	GND	Ground potential
3	RxD/TxD-P	Data+
4	RxD/TxD-N	Data-

8.1.2 Status LEDs

8.1.2.1 LED „RN“

The LED labelled „RN“ indicates the state of the EtherCAT-ASIC.

State	LED, flash code	Explanation
init	Off	Initialising, no data exchange
Pre-Op	Off/green, 1:1	Pre-operational, no data exchange
Safe-Op	Off/green, 5:1	Safe operation, inputs readable
Op	Green, on	Operational, unrestricted data exchange

8.1.2.2 „IO“ LED

The LED labelled „IO“ indicates the state of the EtherCAT-ASIC.

State	LED, flash code	Explanation
Ok	Green, on	No error
Error	Red, flashing light	1 x short circuit
		2 x undervoltage
Start, defective	Red	Module not Initialised

8.1.2.3 LED „PW“

State	LED, flash code	Explanation
On	Green, on	24 VDC supply available
Off	Off	24 VDC supply not available

Function (CoE variant)

The MIX 02 module has 4 interruptible digital inputs (can also be used as counter), 4 analog inputs (can also be used as digital inputs) and 24 digital outputs.

The IOs and the module status are accessed via process data objects, which are mapped in variables in the control program of the EtherCAT master.

8.1.3 Inputs

The following input values can be found in the group inputs:

Variable	Data type	Explanation	
StateWord	UINT	Status word	
		Bit0	RS485 received data available
		Bit1	RS485 receive overflow
		Bit2	Short circuit (overload) outputs
		Bit3	Undervoltage CPU
		Bit4	Undervoltage In/Out (load)
		Bit5	EtherCAT watchdog error
		Bit6...15	free
DigitalInput0	BOOL	Digital input 0	
DigitalInput1	BOOL	Digital input 1	
DigitalInput2	BOOL	Digital input 2	
DigitalInput3	BOOL	Digital input 3	
DigitalInput4	BOOL	Digital input 4	
DigitalInput5	BOOL	Digital input 5	
DigitalInput6	BOOL	Digital input 6	
DigitalInput7	BOOL	Digital input 7	
Counter	UDINT	Counter reading from event counter at DI5...7	
SampleCycleCounter	UINT	is incremented when new analog values are available	

8.1.3.1 AnalogIn0

The following input values can be found in the group AnalogIn0:

Variable	Data type	Explanation
AnalogIn0_Sample0	UINT	Analog input 0, measurement n
AnalogIn0_Sample1	UINT	Analog input 0, measurement n+1
AnalogIn0_Sample2	UINT	Analog input 0, measurement n+2
AnalogIn0_Sample3	UINT	Analog input 0, measurement n+3
AnalogIn0_Sample4	UINT	Analog input 0, measurement n+4

8.1.3.2 AnalogIn1

The following input values can be found in the group AnalogIn1:

Variable	Data type	Explanation
AnalogIn1_Sample0	UINT	Analog input 1, measurement n
AnalogIn1_Sample1	UINT	Analog input 1, measurement n+1
AnalogIn1_Sample2	UINT	Analog input 1, measurement n+2
AnalogIn1_Sample3	UINT	Analog input 1, measurement n+3
AnalogIn1_Sample4	UINT	Analog input 1, measurement n+4

8.1.3.3 AnalogIn2

The following input values can be found in the group AnalogIn2:

Variable	Data type	Explanation
AnalogIn2_Sample0	UINT	Analog input 2, measurement n
AnalogIn2_Sample1	UINT	Analog input 2, measurement n+1
AnalogIn2_Sample2	UINT	Analog input 2, measurement n+2
AnalogIn2_Sample3	UINT	Analog input 2, measurement n+3
AnalogIn2_Sample4	UINT	Analog input 2, measurement n+4

8.1.3.4 AnalogIn3

The following input values can be found in the group AnalogIn3:

Variable	Data type	Explanation
AnalogIn3_Sample0	UINT	Analog input 3, measurement n
AnalogIn3_Sample1	UINT	Analog input 3, measurement n+1
AnalogIn3_Sample2	UINT	Analog input 3, measurement n+2
AnalogIn3_Sample3	UINT	Analog input 3, measurement n+3
AnalogIn3_Sample4	UINT	Analog input 3, measurement n+4

8.1.4 Outputs

The following input values can be found in the group outputs:

Variable	Data type	Explanation	
Controlword	UINT	Bit0	Error message reset
		Bit1	Counter reset (Function by edge 0->1)
		Bit2...15	free
DigitalOutput0	BOOL	Digital output 0	
DigitalOutput1	BOOL	Digital output 1	
DigitalOutput2	BOOL	Digital output 2	
DigitalOutput3	BOOL	Digital output 3	
DigitalOutput4	BOOL	Digital output 4	
DigitalOutput5	BOOL	Digital output 5	
DigitalOutput6	BOOL	Digital output 6	
DigitalOutput7	BOOL	Digital output 7	
DigitalOutput8	BOOL	Digital output 8	
DigitalOutput9	BOOL	Digital output 9	
DigitalOutput10	BOOL	Digital output 10	
DigitalOutput11	BOOL	Digital output 11	
DigitalOutput12	BOOL	Digital output 12	
DigitalOutput13	BOOL	Digital output 13	
DigitalOutput14	BOOL	Digital output 14	
DigitalOutput15	BOOL	Digital output 15	
DigitalOutput16	BOOL	Digital output 16	
DigitalOutput17	BOOL	Digital output 17	
DigitalOutput18	BOOL	Digital output 18	
DigitalOutput19	BOOL	Digital output 19	
DigitalOutput20	BOOL	Digital output 20	
DigitalOutput21	BOOL	Digital output 21	
DigitalOutput22	BOOL	Digital output 22	
DigitalOutput23	BOOL	Digital output 23	
DigitalOutput24	BOOL	Digital output 24	

8.1.5 Object Dictionary

Index	Name	Type	Default	Min. Max.	Access
1000	Device Typ	UINT32	0xF0191		RO
1008	Device Name	String	MIX 02		RO
1009	Hardware Version	String	1.0		RO
100A	Software Version	String	2.00		RO
1018	Identity Object	Array			
1018, 1	Vendor Id	UINT32	0x0048554B		RO
1018, 2	Product Code	UINT32	177173		RO
1018, 3	Revision Number	UINT32	2		RO
1018, 4	Serial Number	UINT32	0		RO
2000	OversamplingCount	UINT8	5	1,5	RW
2001	Rs485Baudrate	UINT8	2	0,9	RW
2002	Rs485Data	Octet-String 10			RW
6000	Counter	UINT32			RO P
6001	Digital Inputs	Array			
6001, 1...8	DigitalIn0...7	BOOL			RO P
6010	SampleCycle-Counter	UINT16			RO P
6401	AnalogIn0	Array			
6401, 1...5	Sample0...4	UINT16			RO P
6402	AnalogIn1	Array			
6402, 1	Sample0	UINT16			RO P
6402, 2	Sample1	UINT16			RO P
6402, 3	Sample2	UINT16			RO P
6402, 4	Sample3	UINT16			RO P
6402, 5	Sample4	UINT16			RO P
6403	AnalogIn2	Array			
6403, 1...5	Sample0...5	UINT16			RO P
6404	AnalogIn3	Array			
6404, 1...5	Sample0...5	UINT16			RO P
6500	StateWord	UINT16			RO P
7000	DigitalOutputs	Array			
7000, 1...24	DigitalOut0...23	BOOL			RW P
7001	ControlWord	UINT16			RW P

RO=Read only, RW= Read/Write, P=Process image

8.1.6 Analog inputs / Oversampling

The measured values of the analog inputs are determined cyclically on the module and provided in variables for retrieval by the EtherCAT master. Both the cycle time of the analog conversions and the EtherCAT cycle define the evaluation of an analog value curve.

For a precise evaluation, the module offers oversampling with adjustable parameters. There are 2 control methods which can already be selected in the configurator:

SM synchronous (SM=Sync master)

DC synchronous (DC=Distributed Clocks)

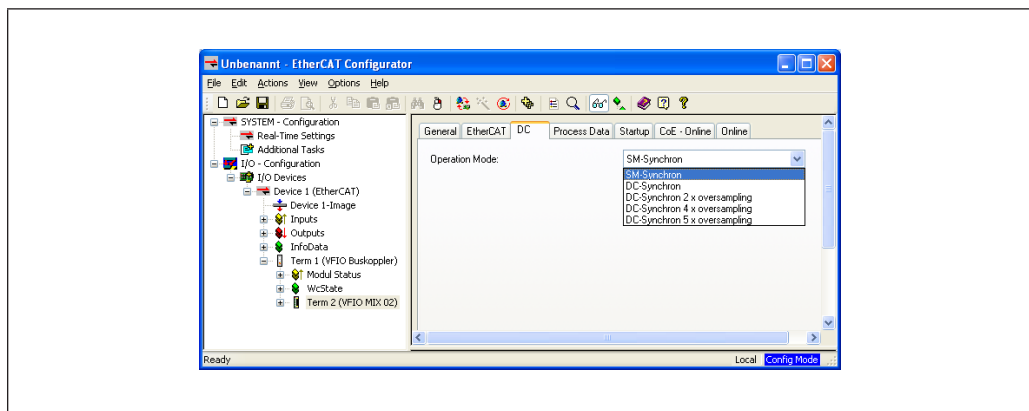

Figure 20: Analog inputs / Oversampling

8.1.7 Analog inputs / Oversampling SM synchronous

Analog inputs / Oversampling SM synchronous

The module measures 4 analog values every millisecond. Depending on the setting of the oversampling parameter (object index 0x2000), these values are entered into the process image. The default setting is 5.

With this setting, the analog process image is only renewed after 5ms (recognizable by the incremented counter Inputs, SampleCycleCounter). The millisecond measured values are in sample 0 to 4 of the variables on AnalogIn0... AnalogIn4.

If the parameter value is smaller, the process image is updated faster and the unused sample values remain empty.

Example:

If the oversampling parameter is set to 1, a new process image will be generated after only one millisecond.

Then the values are set to sample 0. Sample 1 to 4 are unused.

Oversampling DC synchronous

The SYNC0 interrupt is used for analog measurement and the SYNC1 interrupt for transferring the data to the process image.

The SYNC0 can be faster by the factor of 1 to 5 than the SYNC1.

Example1:

Bus cycle is 5ms. The setting is "DC synchronous 5 x oversampling".

Sync1 is triggered every 5ms and SYNC0 every 1ms.

The analog values are measured every millisecond and entered after 5ms into the process image on sample 0 to 4. The SampleCycleCounter is incremented after 5ms.

Example2:

Bus cycle is 2ms. The setting is "DC synchronous 4 x oversampling".

Sync1 is triggered every 2ms and SYNC0 every 0.5ms.

The analog values are measured every half millisecond and entered after 2ms into the process image on sample 0 to 3. Sample4 remains 0. The SampleCycleCounter is incremented after 2ms.

Example3:

Bus cycle is 1ms. The setting is "DC synchronous".

Sync0 is triggered every 1ms.

The analog values are measured every millisecond and entered into the process image on sample 0. Sample1 to 4 remain 0.

The SampleCycleCounter is incremented after 1ms.

RS485

The baud rate of the RS485 is set via the object 0x2001.

Value	Baud rate
0	2400
1	4800
2 (default)	9600
3	19200
4	38400
5	57600
6	115200
7	230400
8	460800
9	921600

Data is sent and received via object 0x2002..

Byte	Explanation
0	Number of data
1	-
2	Data Byte 0
...	...
9	Data Byte 7

If the object is written, [number of data] are sent from the data of bytes 0 to 7.

If the object is read, a maximum of 8 data bytes are taken from the receive queue.

If [Number of data] = 0, no data was received.

The SDO transfer to and from the object has always a length of 10 bytes.

If there are data in the receive queue, this is indicated by bit0 in the StateWord.

The receive buffer contains a maximum of 1024 bytes. An overflow is signalled by bit1 in the StateWord.

Counter

Parallel to the use as digital inputs, inputs DI5 to 7 are evaluated for an event counter.

The counter value Inputs, Counter is a 32 bit value.

- The counting cycle is connected to DI5.
- The counting direction is determined by the state of DI6.

If DI6=FALSE, each rising edge at DI5 will increment inputs, counters.

If DI6=TRUE, each rising edge at DI5 will decrement inputs data, position counter.

Input and counter are set to value 0 by rising edge at DI7.

The counter value can also be reset by software (rising edge at outputs, ControlWord Bit1).

Analog inputs / Oversampling

Analog value conversion runs cyclically every 1ms and is not synchronised with the receipt of EtherCAT telegrams.

The module offers oversampling.

Depending on the setting of the oversampling parameter, the measured values are entered into the process image. The default setting is 5:

With this setting, the analog values in the process image are only renewed after 5 ms as a consistent set (recognizable by the incremented counter in the StateWord).

The values measured at intervals of 1ms are then available in the variablesAnalogInx_Sample 0 to 4. (x = 0 to 3).

If the oversampling parameter value is smaller, the process image is updated faster and the unused sample values remain empty.

If the oversampling parameter is set to 1, a new process image will be generated after only one millisecond. Then the values are set to sample 0. Sample 1 to 4 are unused.



Validity of the analog values in the EtherCAT master:

Take the EtherCAT cycle into account to assess how much the values stored by the EtherCAT master are up-to-date. The module described in this section will accept the above times from 1 to 5 ms as ideal EtherCAT cycle setup.



Consistency analog values:

The module provides consistent sets of analog values. Note that you must also consistently evaluate the sample values in the master.



Quality of the analog values:

Best results are obtained by connecting the shield of the signal cables to functional earth.

Low voltage

The outputs are switched off with undervoltage CPU or undervoltage load, bits 3 or 4 in inputs and the StateWord are set and the IO-LED of the module flashes (2x).



When the voltage is within the permissible range again (24V -20% to +25%), the error state can be reset again via Outputs, ControlWord Bit0. Then the outputs are switched on again.

Short circuit

The outputs are thermally protected at the output driver. If the permissible current is exceeded, the affected output is switched off, bits 3 are set to Inputs, StateWord and the IO LED of the module flashes (1x).

When the short circuit is removed, the error state can be reset via Outputs, ControlWord Bit0.

8.1.8 Technical data

Digital inputs	4 (8)		
	DI0...3	1ms	
	DI4	0.1ms	
	DI5...7	0.001ms	
Counter (DI5)	500kHz (to 1 MHz)		
Digital outputs	24		
	DO0...7:	0.5A	
	DO8...23:	0.1A	
Analog inputs	4 x 0...10V		
Resolution	12 Bit		
Sampling frequency	1ms		
RS485	electrically isolated		
Baud rate	2.4...921.6 kBit/s		
Connection	e.g. 4 x KDT 621 (9.6 or 19.2 kBit/s)		
Connection I/O / power	Connector 36-pole		
Controller	ASIC ET1200		
Baud rate	100 Mbit/s		
E-bus port	10-pin system plug in side wall		
Term. module	not required		
Voltage supply	24V DC -20% +25%		
E-bus load	90mA		
Part no.	00C6CB1-1600		
Approvals			

9 Analog KEB I/O Modules



Downloading and reading the following old documentation is possible here: [C6 Remote I/Os](#).

Analog inputs/outputs

AI4	00C6CC1-0100
AI4-I	00C6CC1-0200
AI4/8-U	00C6CC1-0300
AI8/16-U	00C6CC1-0400
AO4	00C6CC1-0500

Analog inputs temperature

AI4 PT/NI100	00C6CC1-0700
AI8 PT/NI100	00C6CC1-0800
AI4 PT/NI1000	00C6CC1-0900
AI8 PT/NI1000	00C6CC1-1000
AI4 Thermo	00C6CC1-1100
AI4 Thermo	00C6CC1-1200

9.1 AO4-U/I - 16 Bit (CoE)

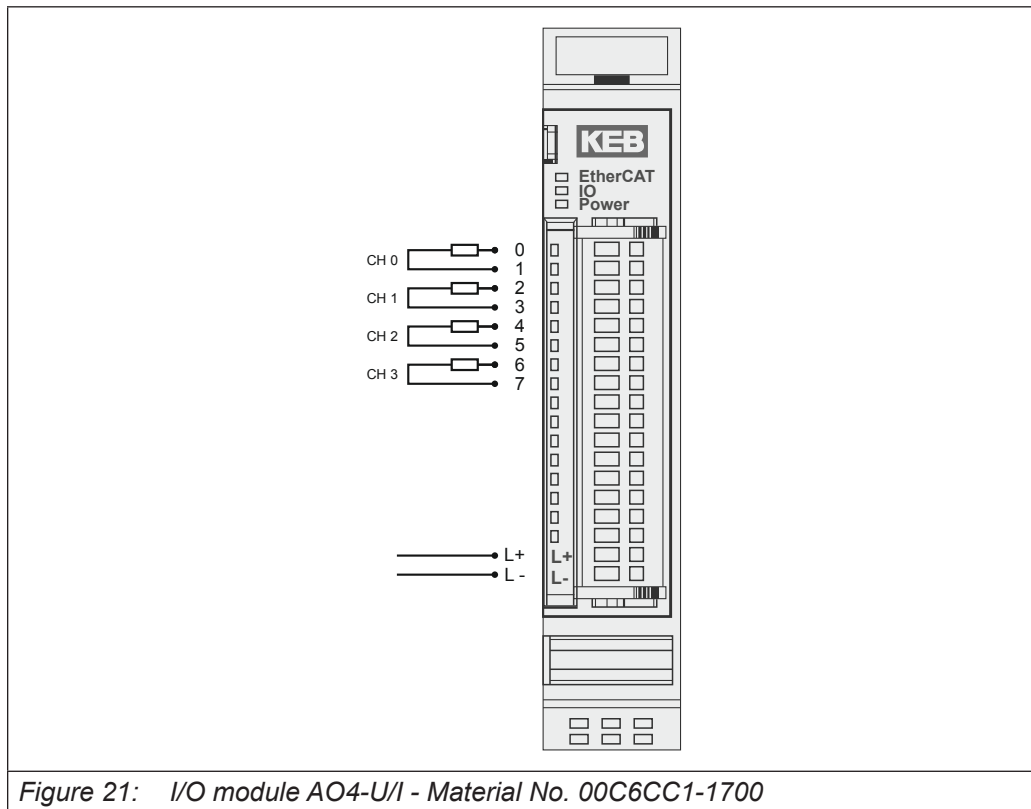

Figure 21: I/O module AO4-U/I - Material No. 00C6CC1-1700

9.1.1 Terminals

Module supply

L+	24 VDC
L-	0V



The module 00C6CC1-1700 KEB-I/O AO4 16Bit (CoE) is the non-compatible successor of the module 00C6CC1-0500 KEB Remote I/O AO4 12Bit.

The module is ETG compliant.

There are changes in the control program of the EtherCAT master necessary, if the module 00C6CC1-0500 KEB-I/O AO4 12 Bit is to be replaced by the module 00C6CC1-1700 KEB-I/O AO4 16 Bit.

Note the following differences:

KEB-I/O AO4 12Bit	KEB-I/O AO4 16Bit (CoE)
Current: 0...+20mA	Current: 0...+20mA
Short circuit detectable	Short circuit not detectable, but outputs with short circuit protection
Output asynchron to the EtherCAT	Output SM or DC-synchron

The output of the analog values can be DC-synchron (Distributed Clocks) or SM-synchron (Sync Manager).

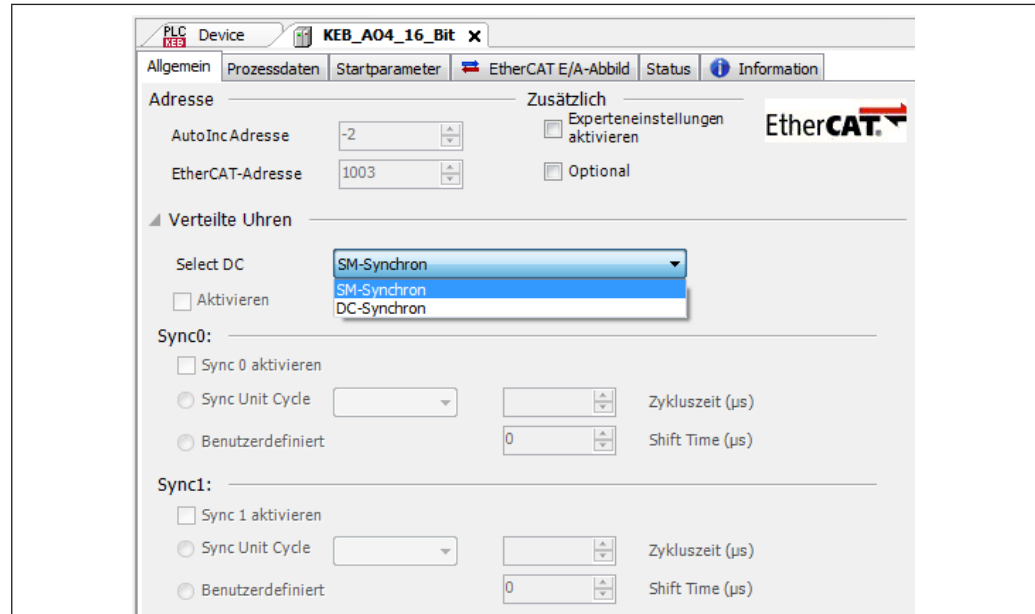

Figure 22: DC-synchron (Distributed Clocks) / SM-synchron (Sync Manager)

The output values and the module status are accessed via process data objects, which are mapped in variables in the control program of the EtherCAT master.

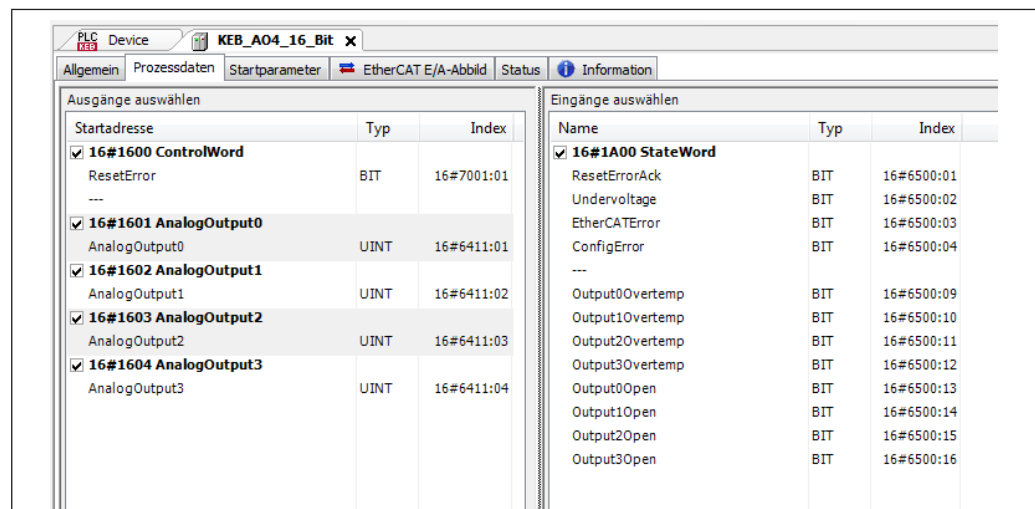

Figure 23: Process data objects

Service data objects are configured for information and settings.

Settings for the AO4 16Bit module, such the properties of the individual outputs, can already be made offline in the configurator. Then these are executed by the EtherCAT master during startup.

With the SDO transfer module available for the EtherCAT master, it is also possible to make runtime settings.

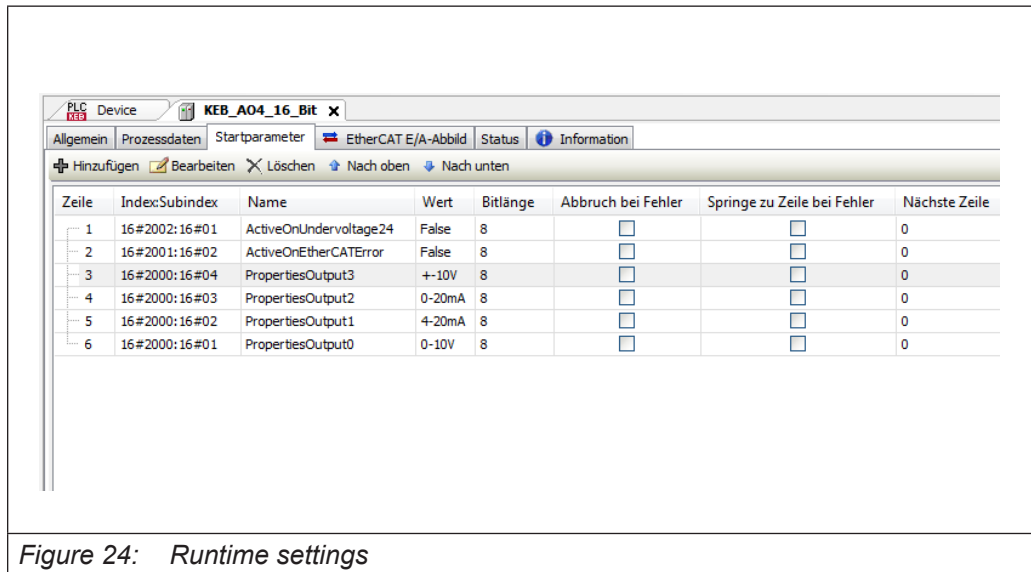

Figure 24: Runtime settings

Press the "Add..." button, select the object and set the desired value.

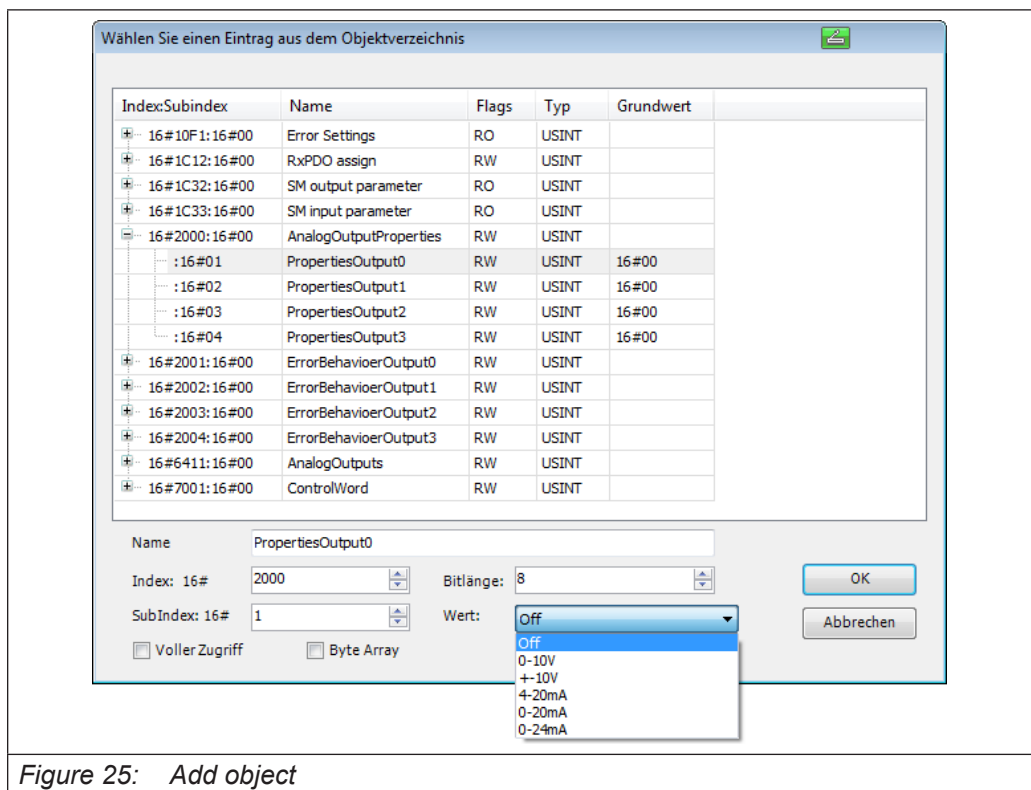

Figure 25: Add object

9.1.2 Status LEDs

9.1.2.1 LED „EtherCAT Run“

The LED labelled „EtherCAT Run“ indicates the state of the EtherCAT ASIC.

State	LED, flash code	Explanation
init	Off	Initialising, no data exchange
Pre-Op	Off/green, 1:1	Pre-operational, no data exchange
Safe-Op	Off/green, 5:1	Safe operation, inputs readable
Op	Green, on	Operational, unrestricted data exchange

9.1.2.2 „IO“ LED

State	LED, flash code	Explanation
OK	Green, on	No error
Error	Off	Malfunction of module if E-bus LED = On Inoperative if E-bus LED = Off
	Red, 1 x	Short circuit
	Red, 2 x	Low voltage
	Red, 3 x	Watchdog internal
	Red, 4 x	EtherCat watchdog control
	Red, 7 x	Configuration error (E-Bus in Pre-Op state), number of process data differs from that in the module
Defective	Red, on	Module defective

9.1.2.3 „Power“ LED

The LED labelled "Power" indicates the state of the I/O module's I/O power supply.

State	LED, flash code	Explanation
On	Green, on	24 VDC supply available
Off	Off	24 VDC supply not available

9.1.2.4 LED „Channel“

State	LED, flash code	Explanation
On	Green, on	Channel enabled
Off	Off	Channel disabled
Error	Red, 1 x	Short circuit
	Red, 3 x	Broken wire
	Red, 5 x	Overtemperature of the output driver

9.1.3 Function

The AO4 module has 4 analog outputs. Every channel can be separately set to the unipolar or bipolar for output of voltages or current.

To output voltage or current values at the analog outputs (measured values), the values must be written in 2 byte two-complement format into the corresponding output variables. The letter n in the tables below represents the channel number ($n=0\dots3$).

Measured value				Variable value (at 16 Bit)			
± 10	0 ... 20	4 ... 20	0 ... 24	Bipolar [UINT]		Unipolar [UINT]	
V	mA	mA	mA	decimal	hexadecimal	decimal	hexadecimal
-10				-32768	16#8000		
-9				-29492	16#8CCC		
-8				-26215	16#9999		
-7				-22938	16#A666		
-6				-19661	16#B333		
-5				-16384	16#C000		
-4				-13108	16#CCCC		
-3				-9831	16#D999		
-2				-6554	16#E666		
-1				-3292	16#F324		
0	0	4	0	0	0	0	0
1	2	5,6	2,4	3276	16#0CCC	6553	16#1999
2	4	7,2	4,8	6553	16#1999	13107	16#3332
3	6	8,8	7,2	9830	16#2666	19660	16#4CCC
4	8	10,4	9,6	13106	16#3332	26214	16#6665
5	10	12,0	12,0	16383	16#3FFF	32767	16#7FFF
6	12	13,6	14,4	19660	16#4CCC	39320	16#9998
7	14	15,2	16,8	22936	16#5998	45874	16#B332
8	16	16,8	19,2	26213	16#6665	52427	16#CCCB
9	18	18,4	21,6	29490	16#7332	58981	16#E665
10	20	20,0	24,0	32767	16#7FFF	65534	16#FFFE

9.1.4 StateWord

The status word contains messages about the state of the module:

Bit	Name	Explanation
0	ResetErrorAck	Acknowledge for "Reset Error" in Module Control
1	Undervoltage24	Undervoltage 24V supply
2	EtherCATError	Sync Manager Watchdog
3	ConfigError	Mismatch of Sync Manager's quantity structure
4	-	
5	-	
6	-	
7	-	
8	Output 0 Overtemp	Output driver has detected overtemperature (automatic switch-off)
9	Output 1 Overtemp	Output driver has detected overtemperature (automatic switch-off)
10	Output 2 Overtemp	Output driver has detected overtemperature (automatic switch-off)
11	Output 3 Overtemp	Output driver has detected overtemperature (automatic switch-off)
12	Output 0 Open	In current mode, when no current is flowing
13	Output 1 Open	In current mode, when no current is flowing
14	Output 2 Open	In current mode, when no current is flowing
15	Output 3 Open	In current mode, when no current is flowing

9.1.5 Analog outputs

Write the output values into the following variables:

Variable	Data type	Explanation
c	UINT	Output value for channel n (n=0...3).

9.1.6 ControlWord

The control word contains a bit for error acknowledgement.

Bit	Name	Explanation
0	ResetError	0 -> Errors remain active, 1 -> Error is reset (error cause removed)
1-15	-	not used

9.1.7 Object Dictionary



Index	Name	Type	Default	Min Max	Access
1000	Device Typ	UINT32	0xF0191		RO
1001	Error Register	UINT8			RO
1008	Device Name	String			RO
1009	Hardware Version	String	1.00		RO
100A	Software Version	String	1.00		RO
1018	Identity Object	Array			
1018, 0	Number of Entries	UINT8	4		RO
1018, 1	Vendor Id	UINT32	0x0048554B		RO
1018, 2	Product Code	UINT32			RO
1018, 3	Revision Number	UINT32	2		RO
1018, 4	Serial Number	UINT32	0		RO
2000	Analog Output Properties	Array			
2000, 0	Number of Entries	UINT8	4		RO
2000, 1	Properties Output 0	UINT8	0-10V	Off (0), 0-10V (1), +-10V (3), 0-20mA (6), 4-20mA (5), 0-24mA (7)	RW
2000, 2	Properties Output 1	UINT8	0-10V	Off, 0-10V, +-10V, 0-20mA, 4-20mA, 0-24mA	RW
2000, 3	Properties Output 2	UINT8	0-10V	Off, 0-10V, +-10V, 0-20mA, 4-20mA, 0-24mA	RW
2000, 4	Properties Output 3	UINT8	0-10V	Off, 0-10V, +-10V, 0-20mA, 4-20mA, 0-24mA	RW
2001	ErrorBehavior Output 0	Array			

2001, 0	Number of Entries	UINT8	2		RO
2001, 1	Active on Undervoltage 24	BOOL	FALSE		RW
2001, 1	Active on EtherCAT Watchdog Error	BOOL	FALSE		RW
2002	ErrorBehavior Output 1	Array			
2002, 0	Number of Entries	UINT8	2		RO
2002, 1	Active on Undervoltage 24	BOOL	FALSE		RW
2002, 1	Active on EtherCAT Watchdog Error	BOOL	FALSE		RW
2003	ErrorBehavior Output 2	Array			
2003, 0	Number of Entries	UINT8	2		RO
2003, 1	Active on Undervoltage 24	BOOL	FALSE		RW
2003, 1	Active on EtherCAT Watchdog Error	BOOL	FALSE		RW
2004	ErrorBehavior Output 3	Array			
2004, 0	Number of Entries	UINT8	2		RO
2004, 1	Active on Undervoltage 24	BOOL	FALSE		RW
2004, 1	Active on EtherCAT Watchdog Error	BOOL	FALSE		RW
6411	Analog Outputs	Array			
6411, 0	Number of Entries	UINT8	4		RO
6411, 1	Analog Output 0	UINT16			RW P
6411, 2	Analog Output 1	UINT16			RW P
6411, 3	Analog Output 2	UINT16			RW P
6411, 4	Analog Output 3	UINT16			RW P
6500	State Word	Array			
6500, 0	Number of Entries	UINT8	16		RO
6500, 1	Reset Error Ack	BOOL			RO P
6500, 2	Undervoltage24	BOOL			RO P
6500, 3	EtherCAT Error	BOOL			RO P
6500, 4	ConfigError	BOOL			RO P
6500, 5	-	BOOL			RO P
6500, 6	-	BOOL			RO P
6500, 7	-	BOOL			RO P
6500, 8	-	BOOL			RO P
6500, 9	Output 0 Overtemp	BOOL			RO P
6500, 10	Output 1 Overtemp	BOOL			RO P
6500, 11	Output 2 Overtemp	BOOL			RO P
6500, 12	Output 3 Overtemp	BOOL			RO P
6500, 13	Output 0 Open	BOOL			RO P
6500, 14	Output 1 Open	BOOL			RO P
6500, 15	Output 2 Open	BOOL			RO P

6500, 16	Output 3 Open	BOOL			RO P
7001	Control Word	Array			
7001, 0	Number of Entries	UINT8	1		RO
7001, 1	Reset Error	BOOL			RW P

RO=Read only, RW= Read/Write, P=Process image

9.1.8 Technical data

Analog outputs	4
Resolution	16 Bit
Output frequency	SM /DC synchronous
Basic error	±0.2%
Temperature error	±0.005%/K
Destruction limit against volt-ages applied from outside	15V
Voltage supply	
Measuring range	0 ... 10V, ± 10V
Sort-circuit protection	yes
Sort-circuit current	max. 30mA
Load resistance	min. 1kΩ
Response time	0->10V: 22µs at 2kΩ/<200pF
Current	
Measuring range	0...20mA, 4...20mA, 0...24mA
Load resistance	max. 500Ω, max. 1mH (inductive)
Response time	0->16V: 25µs at 300Ω/<1mH
Baud rate	100 Mbit/s
Controller	ASIC ET1200
E-bus port	10-pin system plug in side wall
Term. module	not required
Connection IO/Power	Connector 18-pole
Voltage supply	24V DC -20% +25%
E-bus load	150mA
Part no.	00C6CC1-1700
Approvals	  

9.2 AI4/8-U 13 Bit (CoE)

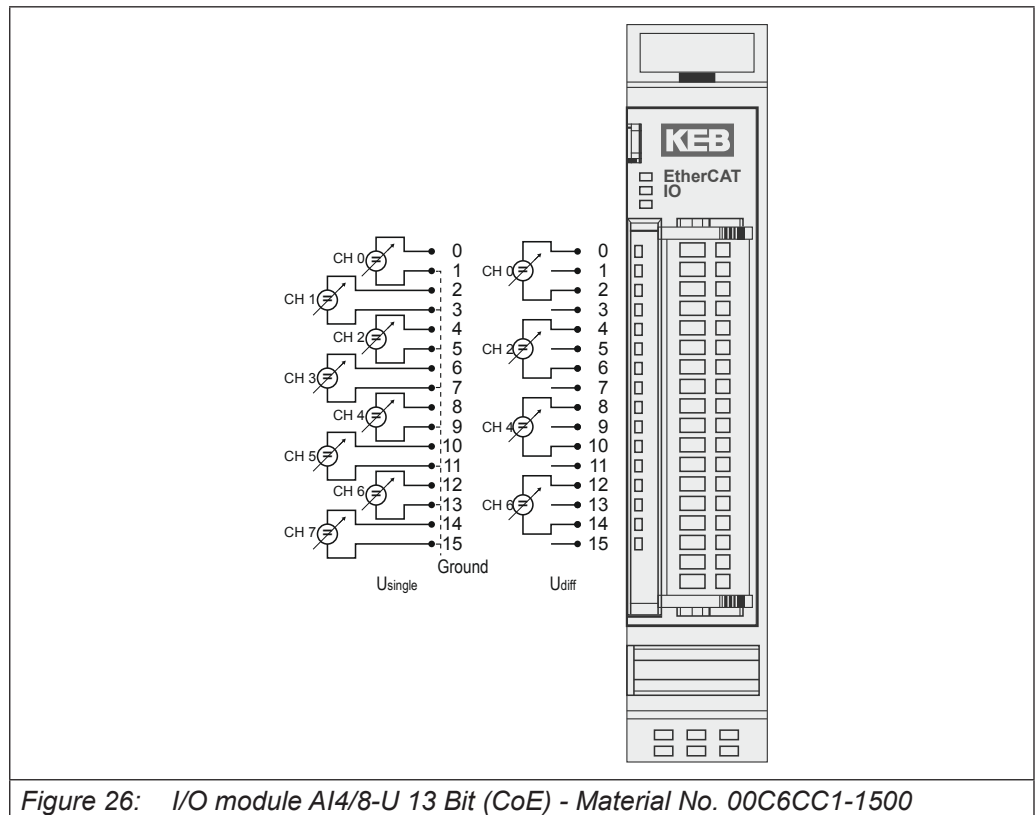

Figure 26: I/O module AI4/8-U 13 Bit (CoE) - Material No. 00C6CC1-1500

Terminals

The module needs no separate 24V connector. Power is supplied to the module through the E-bus connector.



The module 00C6CC1-1500 KEB Remote I/O AI4/8-U 13Bit (CoE) is the non-compatible successor of the module 00C6CC1-0300 KEB Remote I/O AI4/8-U 13Bit.

The module is ETG compliant.

There are changes in the control program of the EtherCAT master necessary, if the module 00C6CC1-0300 KEB Remote I/O AI4/8-U 13Bit is to be replaced by the module 00C6CC1-1500 KEB Remote I/O AI4/8-U 13Bit (CoE).

9.2.1 Status LEDs

9.2.1.1 LED „EtherCAT Run“

The LED labelled „EtherCAT Run“ indicates the state of the EtherCAT ASIC.

State	LED, flash code	Explanation
init	Off	Initialising, no data exchange
Pre-Op	Off/green, 1:1	Pre-operational, no data exchange
Safe-Op	Off/green, 5:1	Safe operation, inputs readable
Op	Green, on	Operational, unrestricted data exchange

9.2.1.2 „IO“ LED

The LED labelled "IO" indicates the state of the module's I/Os.

State	LED, flash code	Explanation
OK	Green, on	No error
Error	Off	Malfunction of module if E-bus LED = On Inoperative if E-bus LED = Off
	Red, 4 x	EtherCat watchdog control
	Red, 7 x	Configuration error (E-Bus in Pre-Op state), number of process data differs from that in the module
Defective	Red, on	Module defective

9.2.1.3 „Power“ LED

There is no LED labelled "Power" because a separate feed-in is not required.

9.2.1.4 LED „Channel“

The "Channel" LEDs display the status of the respective channel.

State	LED, flash code	Explanation
On	Green, on	Channel enabled
Off	Off	Channel disabled

9.2.2 Function

The AI4/8-U module has 8 analog inputs. If signal lines are single ended (measured against earth L-) 8 channels are available. If differential signals shall be measured, two channels are to be used for each, i.e. altogether 4 differential signals can be measured. Channels can be combined as follows: 0/1, 2/3, 4/5 and 6/7.

Measured value			Variable value (at 16 Bit)			
±10	±5V	±2.5V	Bipolar [UINT]		Unipolar [UINT*] *Data type conversion required	
V	V	V	decimal	hexadecimal	decimal	hexadecimal
-10	-5	-2,5	-32768	16#8000		
-9	-4,5	-2,25	-29492	16#8CCC		
-8	-4	-2	-26215	16#9999		
-7	-3,5	-1,75	-22938	16#A666		
-6	-3	-1,5	-19661	16#B333		
-5	-2,5	-1,25	-16384	16#C000		
-4	-2	-1	-13108	16#CCCC		
-3	-1,5	-0,75	-9831	16#D999		
-2	-1	-0,5	-6554	16#E666		
-1	-0,5	-0,25	-3292	16#F324		
0	0	0	0	0	0	0
1	0,5	0,25	3276	16#0CCC	6553	16#1999
2	1	0,5	6553	16#1999	13107	16#3332
3	1,5	0,75	9830	16#2666	19660	16#4CCC
4	2	1	13106	16#3332	26214	16#6665
5	2,5	1,25	16383	16#3FFF	32767	16#7FFF
6	3	1,5	19660	16#4CCC	39320	16#9998
7	3,5	1,75	22936	16#5998	45874	16#B332
8	4	2	26213	16#6665	52427	16#CCCB
9	4,5	2,25	29490	16#7332	58981	16#E665
10	5	2,5	32767	16#7FFF	65534	16#FFFE



If the inputs are not used but switched on, the measured values displayed in the I/O image start to float. To prevent this, deactivate the measuring channel in the start parameters or connect the input to ground (short-circuit when measuring differential signals).

9.2.3 Adjust options

The conversion of the analog values can be DC-synchron (Distributed Clocks) or SM-synchron (Sync Manager).

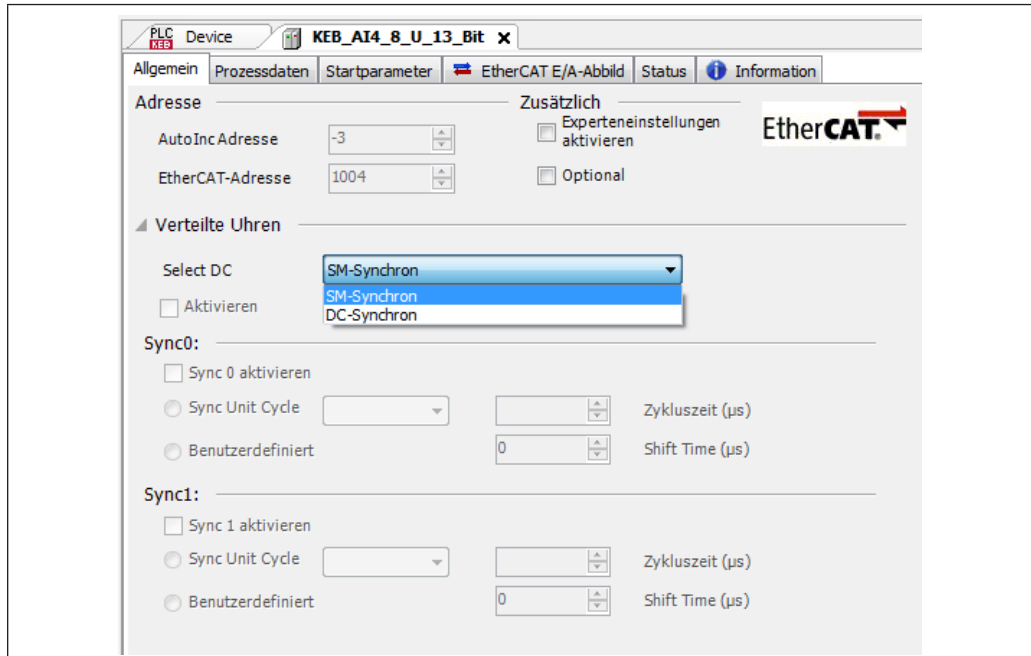

Figure 27: Adjust options

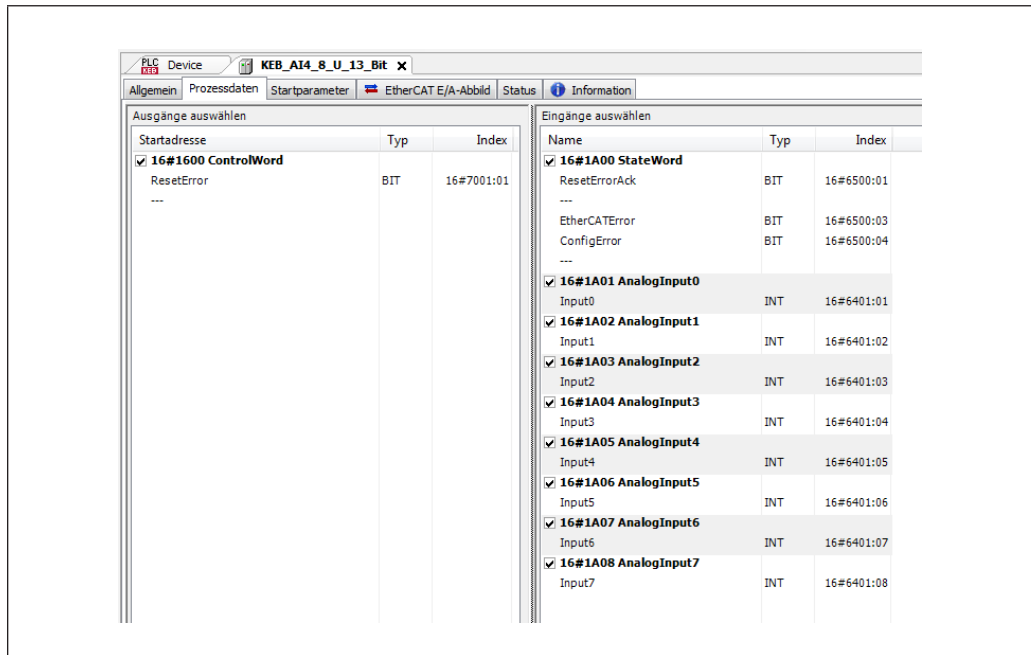

Figure 28: Adjust options

Service data objects are configured for information and settings.

Settings for the AI4/8-U 16Bit module, such the properties of the individual inputs, can already be made offline in the configurator under „Start parameters“. Then these are executed by the EtherCAT master during startup.

With the SDO transfer module available for the EtherCAT master, it is also possible to make runtime settings.

Press the "Add..." button, select the object and set the desired value.

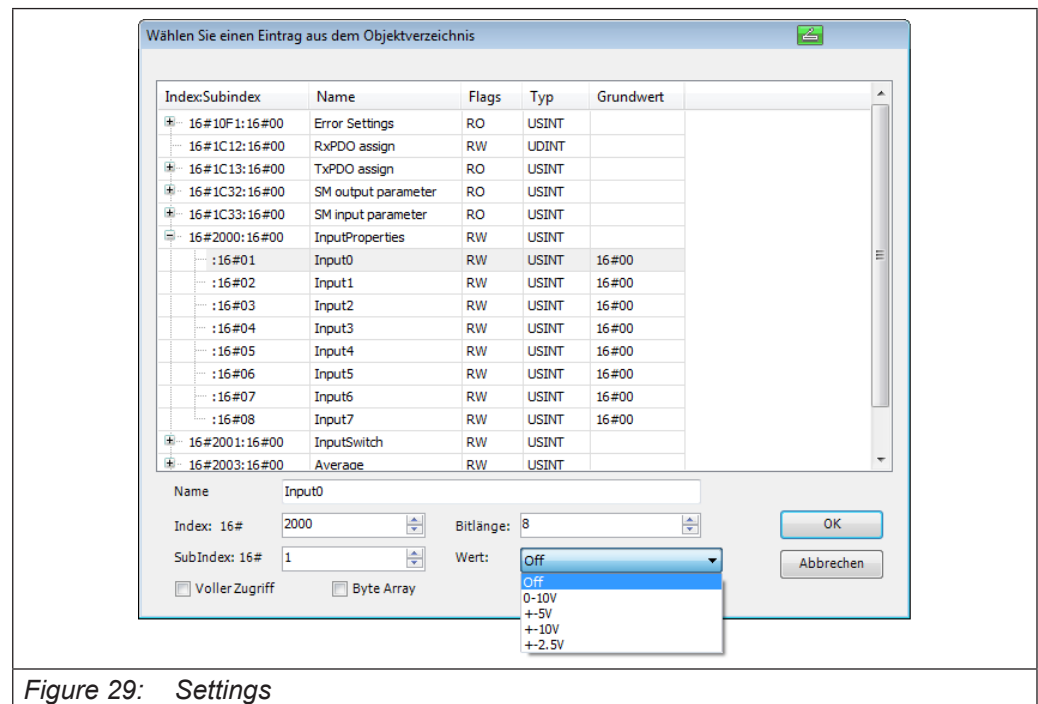

Figure 29: Settings

9.2.4 Options

The following options can be set:

Name	Value	Explanation
InputProperties	0	Off (default)
	1	0-10V
	2	±5V
	3	±10V
	4	±2.5V
InputSwitch	0	Single-Ended (default)
	1	Differential
Average	n=1...255	Inputn= Average value after n cycles (default=1)

9.2.5 StateWord

The status word contains messages about the state of the module:

Bit	Name	Explanation
0	ResetErrorAck	Acknowledge for "Reset Error" in Module Control
1		not used
2	EtherCATError	Sync Manager Watchdog
3	ConfigError	Mismatch of Sync Manager's quantity structure
4-15		not used

9.2.6 Analog inputs

The digitized input values can be found in the following variables:

Variable	Data type	Explanation
Inputn	INT	Value for channel n (n=0...15).

9.2.7 ControlWord

The control word contains a bit for error acknowledgement.

Bit	Name	Explanation
0	ResetError	0 -> Errors remain active, 1 -> Error is reset (error cause removed)
1-15	-	not used

9.2.8 Object Dictionary

Index	Name	Type	Default	Min Max	Access
1000	Device Typ	UINT32	0x40191		RO
1001	Error Register	UINT8			RO
1008	Device Name	String	AI4/8-U 13 Bit		RO
1009	Hardware Version	String	1.00		RO
100A	Software Version	String	1.00		RO
1018	Identity Object	Array			
1018, 0	Number of Entries	UINT8	4		RO
1018, 1	Vendor Id	UINT32	0x0048554B		RO
1018, 2	Product Code	UINT32	185341		RO
1018, 3	Revision Number	UINT32	2		RO

1018, 4	Serial Number	UINT32	0		RO
2000	Analog Input Properties	Array			
2000, 0	Number of Entries	UINT8	16		RO
2000, 1	Input 0	UINT8	Off	Off (0), 0-10V (1), +5V (2) +-10V (3) +-2.5V (4)	RW
2000, 2	Input 1	UINT8	Off	Off (0), 0-10V (1), +5V (2) +-10V (3) +-2.5V (4)	RW
2000, 3	Input 2	UINT8	Off	Off (0), 0-10V (1), +5V (2) +-10V (3) +-2.5V (4)	RW
2000, 4	Input 3	UINT8	Off	Off (0), 0-10V (1), +5V (2) +-10V (3) +-2.5V (4)	RW
2000, 5	Input 4	UINT8	Off	Off (0), 0-10V (1), +5V (2) +-10V (3) +-2.5V (4)	RW
2000, 6	Input 5	UINT8	Off	Off (0), 0-10V (1), +5V (2) +-10V (3) +-2.5V (4)	RW
2000, 7	Input 6	UINT8	Off	Off (0), 0-10V (1), +5V (2) +-10V (3) +-2.5V (4)	RW



ANALOG KEB I/O MODULES

2000, 8	Input 7	UINT8	Off	Off (0), 0-10V (1), +5V (2) +10V (3) +-2.5V (4)	RW
2001	Input Switch	Array			
2001, 0	Number of Entries	UINT8	4		RO
2001, 1	Input_1 Switch	UINT8	Single-ended	Single-ended (0) Differential (1)	RW
2001, 2					
2001, 3					
2001, 4					
2003	Input Average	Array			
2003, 0	Number of Entries	UINT8	16		RO
2003, 1	Input 0 Average	UINT8	1	1...255	RW
2003, 2	Input 1 Average	UINT8	1	1...255	RW
2003, 3	Input 2 Average	UINT8	1	1...255	RW
2003, 4	Input 3 Average	UINT8	1	1...255	RW
2003, 5	Input 4 Average	UINT8	1	1...255	RW
2003, 6	Input 5 Average	UINT8	1	1...255	RW
2003, 7	Input 6 Average	UINT8	1	1...255	RW
2003, 8	Input 7 Average	UINT8	1	1...255	RW
6401	Analog Input	Array			
6401, 0	Number of Entries	UINT8	16		RO
6401, 1	Analog Input 0	UINT16			RO P
6401, 2	Analog Input 1	UINT16			RO P
6401, 3	Analog Input 2	UINT16			RO P
6401, 4	Analog Input 3	UINT16			RO P
6401, 5	Analog Input 4	UINT16			RO P
6401, 6	Analog Input 5	UINT16			RO P
6401, 7	Analog Input 6	UINT16			RO P
6401, 8	Analog Input 7	UINT16			RO P
6500	StateWord	Array			
6500, 0	Number of Entries	UINT8	16		RO
6500, 1	ResetErrorAck	BOOL			RO P
6500, 3	EtherCAT Error	BOOL			RO P
6500, 4	ConfigError	BOOL			RO P
7001	Module Control	Array			

7001, 0	Number of Entries	UINT8	1		RO
7001, 1	Reset Error	BOOL			RW P

RO=Read only, RW= Read/Write, P=Process image

9.2.9 Technical data

Analog inputs	8 single ended respectively 4 differential		
Measuring range	0 ... 10V, $\pm 5V$, $\pm 10V$, $\pm 2.5V$		
Resolution	13 Bit		
Start AD conversion	DC-synchron, SM-synchron		
Conversion time	580 μs (if all channels are enabled)		
Internal resistance	> 1M Ω		
Limit frequency input filter	typically 1 kHz		
Measuring error	< $\pm 0.4\%$, typically < $\pm 0.2\%$ of final value		
Baud rate	100 Mbit/s		
Controller	ASIC ET1200		
E-bus port	10-pin system plug in side wall		
Term. module	not required		
Connection IO/Power	Connector 36-pole		
Voltage supply	24V DC -20% +25%		
E-bus load	190mA		
Part no.	00C6CC1-1500		
Approvals		 LISTED Prog. Cntrl. E479848	 Conformance tested

9.3 AI8/16-U 13 Bit (CoE)

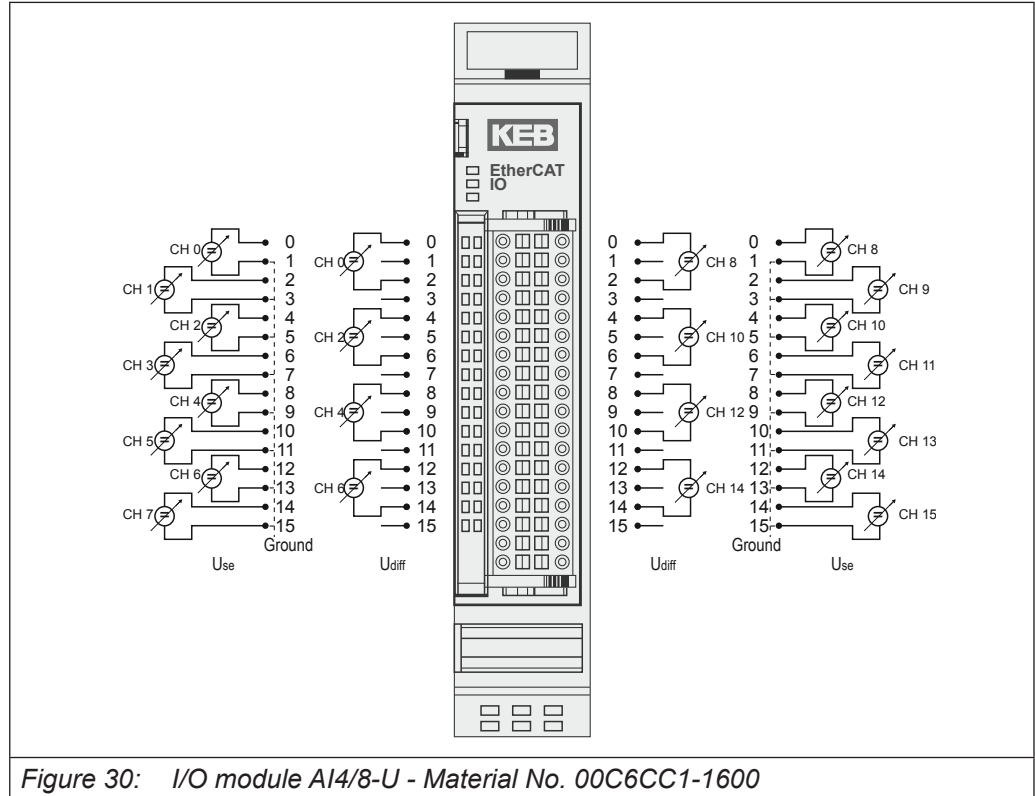

Figure 30: I/O module AI4/8-U - Material No. 00C6CC1-1600

Terminals

The module needs no separate 24V connector. Power is supplied to the module through the E-bus connector.



The module 00C6CC1-1600 KEB Remote I/O AI8/16-U 13Bit (CoE) is the non-compatible successor of the module 00C6CC1-0400 KEB Remote I/O AI8/16-U 13Bit.

The module is ETG compliant.

There are changes in the control program of the EtherCAT master necessary, if the module 00C6CC1-0400 KEB Remote I/O AI8/16-U 13Bit is to be replaced by the module 00C6CC1-1600 KEB Remote I/O AI8/16-U 13Bit (CoE).

9.3.1 Status LEDs

9.3.1.1 LED „EtherCAT Run“

The LED labelled „EtherCAT Run“ indicates the state of the EtherCAT ASIC.

State	LED, flash code	Explanation
init	Off	Initialising, no data exchange
Pre-Op	Off/green, 1:1	Pre-operational, no data exchange
Safe-Op	Off/green, 5:1	Safe operation, inputs readable
Op	Green, on	Operational, unrestricted data exchange

9.3.1.2 „IO“ LED

The LED labelled "IO" indicates the state of the module's I/Os.

State	LED, flash code	Explanation
OK	Green, on	No error
Error	Off	Malfunction of module if E-bus LED = On Inoperative if E-bus LED = Off
	Red, 4 x	EtherCat watchdog control
	Red, 7 x	Configuration error (E-Bus in Pre-Op state), number of process data differs from that in the module
Defective	Red, on	Module defective

9.3.1.3 „Power“ LED

There is no LED labelled "Power" because a separate feed-in is not required.

9.3.1.4 LED „Channel“

The "Channel" LEDs display the status of the respective channel.

State	LED, flash code	Explanation
On	Green, on	Channel enabled
Off	Off	Channel disabled

9.3.2 Function

The AI8/16-U module has 16 analog inputs. If signal lines are single ended (measured against earth L-) 16 channels are available. If differential signals shall be measured, two channels are to be used for each, i.e. altogether 8 differential signals can be measured. Channels can be combined as follows: 0/1, 2/3, 4/5, 6/7, 8/9, 10/11, 12/13 and 14/15.

Measured value			Variable value (at 16 Bit)			
±10	±5V	±2.5V	Bipolar [UINT]		Unipolar [UINT*] *Data type conversion required	
V	V	V	decimal	hexadecimal	decimal	hexadecimal
-10	-5	-2,5	-32768	16#8000		
-9	-4,5	-2,25	-29492	16#8CCC		
-8	-4	-2	-26215	16#9999		
-7	-3,5	-1,75	-22938	16#A666		
-6	-3	-1,5	-19661	16#B333		
-5	-2,5	-1,25	-16384	16#C000		
-4	-2	-1	-13108	16#CCCC		
-3	-1,5	-0,75	-9831	16#D999		
-2	-1	-0,5	-6554	16#E666		
-1	-0,5	-0,25	-3292	16#F324		
0	0	0	0	0	0	0
1	0,5	0,25	3276	16#0CCC	6553	16#1999
2	1	0,5	6553	16#1999	13107	16#3332
3	1,5	0,75	9830	16#2666	19660	16#4CCC
4	2	1	13106	16#3332	26214	16#6665
5	2,5	1,25	16383	16#3FFF	32767	16#7FFF
6	3	1,5	19660	16#4CCC	39320	16#9998
7	3,5	1,75	22936	16#5998	45874	16#B332
8	4	2	26213	16#6665	52427	16#CCCB
9	4,5	2,25	29490	16#7332	58981	16#E665
10	5	2,5	32767	16#7FFF	65534	16#FFFE

 If the inputs are not used but switched on, the measured values displayed in the I/O image start to float. To prevent this, deactivate the measuring channel in the start parameters or connect the input to ground (short-circuit when measuring differential signals).

9.3.3 Adjust options

The conversion of the analog values can be DC-synchron (Distributed Clocks) or SM-synchron (Sync Manager).

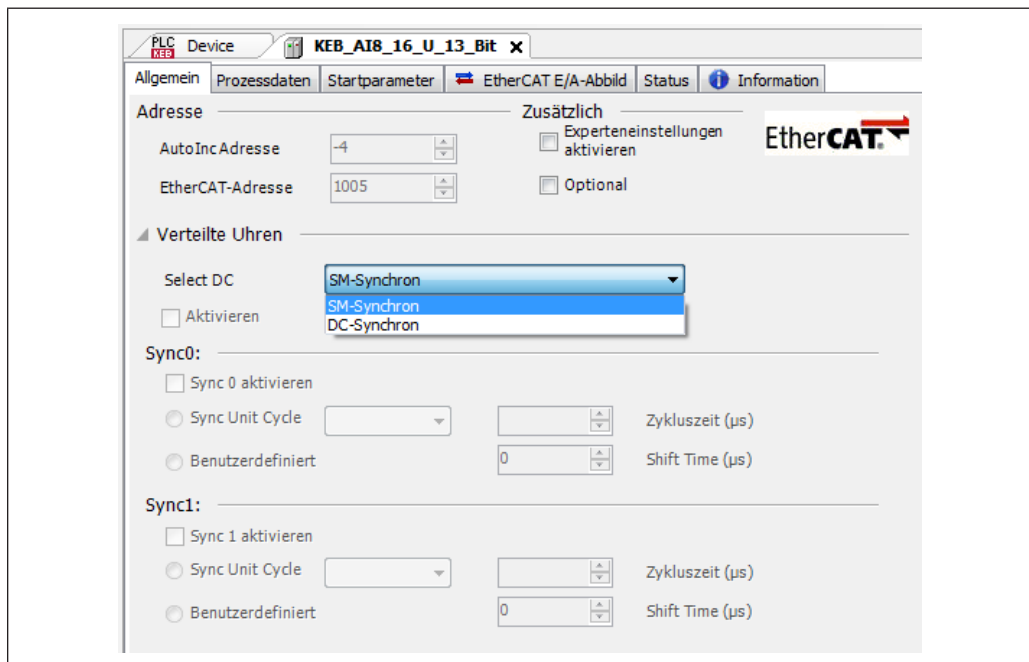

Figure 31: Adjust options

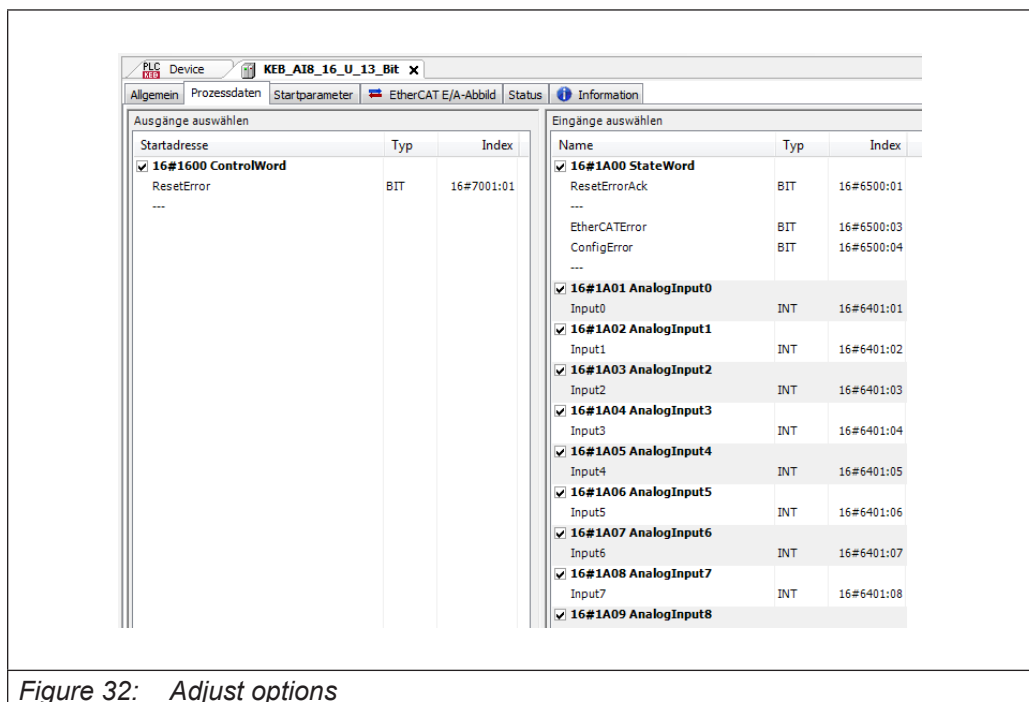

Figure 32: Adjust options

The input values and the module status are accessed via process data objects, which are mapped in variables in the control program of the EtherCAT master.

Service data objects are configured for information and settings.

Settings for the AI4/8-U 16Bit module, such the properties of the individual inputs, can already be made offline in the configurator under „Start parameters“. Then these are executed by the EtherCAT master during startup.

With the SDO transfer module available for the EtherCAT master, it is also possible to make runtime settings.

Press the "Add..." button, select the object and set the desired value.

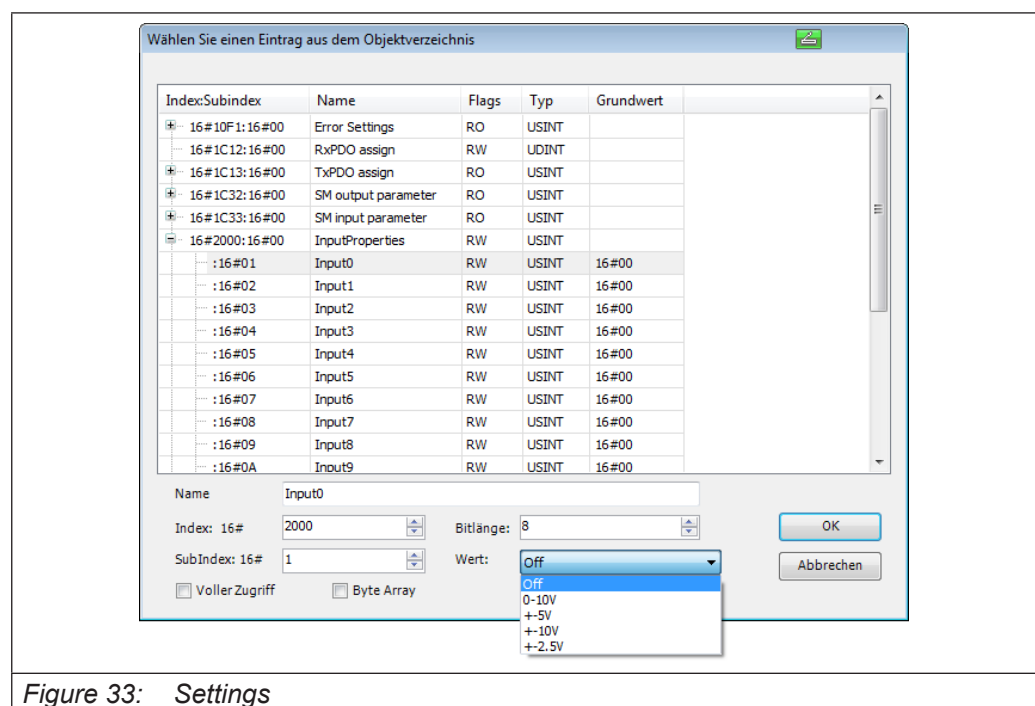

Figure 33: Settings

9.3.4 Options

The following options can be set:

Name	Value	Explanation
InputProperties	0	Off (default)
	1	0-10V
	2	±5V
	3	±10V
	4	±2.5V
InputSwitch	0	Single-Ended (default)
	1	Differential
Average	n=1...255	Inputn= Average value after n cycles (default=1)

9.3.5 StateWord

The status word contains messages about the state of the module:

Bit	Name	Explanation
0	ResetErrorAck	Acknowledge for "Reset Error" in Module Control
1		not used
2	EtherCATErrror	Sync Manager Watchdog
3	ConfigError	Mismatch of Sync Manager's quantity structure
4-15		not used

9.3.6 Analog inputs

The digitized input values can be found in the following variables:

Variable	Data type	Explanation
Inputn	INT	Value for channel n (n=0...15).

9.3.7 ControlWord

The control word contains a bit for error acknowledgement.

Bit	Name	Explanation
0	ResetError	0 -> Errors remain active, 1 -> Error is reset (error cause removed)
1-15	-	not used

9.3.8 Object Dictionary

Index	Name	Type	Default	Min Max	Access
1000	Device Typ	UINT32	0x40191		RO
1001	Error Register	UINT8			RO
1008	Device Name	String	A14/8-U 13 Bit		RO
1009	Hardware Version	String	1.00		RO
100A	Software Version	String	1.00		RO
1018	Identity Object	Array			
1018, 0	Number of Entries	UINT8	4		RO
1018, 1	Vendor Id	UINT32	0x0048554B		RO
1018, 2	Product Code	UINT32	185341		RO
1018, 3	Revision Number	UINT32	2		RO
1018, 4	Serial Number	UINT32	0		RO
2000	Analog Input Properties	Array			
2000, 0	Number of Entries	UINT8	16		RO
2000, 1	Input 0	UINT8	Off	Off (0), 0-10V (1), +5V (2) +-10V (3) +-2.5V (4)	RW
2000, 2	Input 1	UINT8	Off	Off (0), 0-10V (1), +5V (2) +-10V (3) +-2.5V (4)	RW
2000, 3	Input 2	UINT8	Off	Off (0), 0-10V (1), +5V (2) +-10V (3) +-2.5V (4)	RW
2000, 4	Input 3	UINT8	Off	Off (0), 0-10V (1), +5V (2) +-10V (3) +-2.5V (4)	RW
2000, 5	Input 4	UINT8	Off	Off (0), 0-10V (1), +5V (2) +-10V (3) +-2.5V (4)	RW

ANALOG KEB I/O MODULES

2000, 6	Input 5	UINT8	Off	Off (0), 0-10V (1), +-5V (2) +-10V (3) +-2.5V (4)	RW
2000, 7	Input 6	UINT8	Off	Off (0), 0-10V (1), +-5V (2) +-10V (3) +-2.5V (4)	RW
2000, 8	Input 7	UINT8	Off	Off (0), 0-10V (1), +-5V (2) +-10V (3) +-2.5V (4)	RW
2000, 9	Input 8	UINT8	Off	Off (0), 0-10V (1), +-5V (2) +-10V (3) +-2.5V (4)	RW
2000, 10	Input 9	UINT8	Off	Off (0), 0-10V (1), +-5V (2) +-10V (3) +-2.5V (4)	RW
2000, 11	Input 10	UINT8	Off	Off (0), 0-10V (1), +-5V (2) +-10V (3) +-2.5V (4)	RW
2000, 12	Input 11	UINT8	Off	Off (0), 0-10V (1), +-5V (2) +-10V (3) +-2.5V (4)	RW
2000, 13	Input 12	UINT8	Off	Off (0), 0-10V (1), +-5V (2) +-10V (3) +-2.5V (4)	RW



2000, 14	Input 13	UINT8	Off	Off (0), 0-10V (1), +-5V (2) +-10V (3) +-2.5V (4)	RW
2000, 15	Input 14	UINT8	Off	Off (0), 0-10V (1), +-5V (2) +-10V (3) +-2.5V (4)	RW
2000, 16	Input 15	UINT8	Off	Off (0), 0-10V (1), +-5V (2) +-10V (3) +-2.5V (4)	RW
2001	Number of Entries	UINT8	8		RO
2001, 1	Input0_1 Switch	UINT8	Single-ended	Single-ended (0) Differential (1)	RW
2001, 2	Input 2_3 Switch	UINT8	Single-ended	Single-ended (0) Differential (1)	RW
2001, 3	Input 4_5 Switch	UINT8	Single-ended	Single-ended (0) Differential (1)	RW
2001, 4	Input 6_7 Switch	UINT8	Single-ended	Single-ended (0) Differential (1)	RW
2001, 5	Input 8_9 Switch	UINT8	Single-ended	Single-ended (0) Differential (1)	RW
2001, 6	Input 10_11 Switch	UINT8	Single-ended	Single-ended (0) Differential (1)	RW
2001, 7	Input 12_13 Switch	UINT8	Single-ended	Single-ended (0) Differential (1)	RW
2001, 8	Input 14_15 Switch	UINT8	Single-ended	Single-ended (0) Differential (1)	RW
2003	Input Average	Array			
2003, 0	Number of Entries	UINT8	16		RO
2003, 1	Input 0 Average	UINT8	1	1...255	RW
2003, 2	Input 1 Average	UINT8	1	1...255	RW
2003, 3	Input 2 Average	UINT8	1	1...255	RW
2003, 4	Input 3 Average	UINT8	1	1...255	RW
2003, 5	Input 4 Average	UINT8	1	1...255	RW
2003, 6	Input 5 Average	UINT8	1	1...255	RW
2003, 7	Input 6 Average	UINT8	1	1...255	RW
2003, 8	Input 7 Average	UINT8	1	1...255	RW

ANALOG KEB I/O MODULES

2003, 9	Input 8 Average	UINT8	1	1...255	RW
2003, 10	Input 9 Average	UINT8	1	1...255	RW
2003, 11	Input 10 Average	UINT8	1	1...255	RW
2003, 12	Input 11 Average	UINT8	1	1...255	RW
2003, 13	Input 12 Average	UINT8	1	1...255	RW
2003, 14	Input 13 Average	UINT8	1	1...255	RW
2003, 15	Input 14 Average	UINT8	1	1...255	RW
2003, 16	Input 15 Average	UINT8	1	1...255	RW
6401	Analog Input	Array			
6401, 0	Number of Entries	UINT8	16		RO
6401, 1	Analog Input 0	UINT16			RO P
6401, 2	Analog Input 1	UINT16			RO P
6401, 3	Analog Input 2	UINT16			RO P
6401, 4	Analog Input 3	UINT16			RO P
6401, 5	Analog Input 4	UINT16			RO P
6401, 6	Analog Input 5	UINT16			RO P
6401, 7	Analog Input 6	UINT16			RO P
6401, 8	Analog Input 7	UINT16			RO P
6401, 9	Analog Input 8	UINT16			RO P
6401, 10	Analog Input 9	UINT16			RO P
6401, 11	Analog Input 10	UINT16			RO P
6401, 12	Analog Input 11	UINT16			RO P
6401, 13	Analog Input 12	UINT16			RO P
6401, 14	Analog Input 13	UINT16			RO P
6401, 15	Analog Input 14	UINT16			RO P
6401, 16	Analog Input 15	UINT16			RO P
6500	StateWord	Array			
6500, 0	Number of Entries	UINT8	16		RO
6500, 1	ResetErrorAck	BOOL			RO P
6500, 3	EtherCAT Error	BOOL			RO P
6500, 4	ConfigError	BOOL			RO P
7001	Module Control	Array			
7001, 0	Number of Entries	UINT8	1		RO
7001, 1	Reset Error	BOOL			RW P

RO=Read only, RW= Read/Write, P=Process image

9.3.9 Technical data

Analog inputs	16 single-ended respectively 8 differential		
Measuring range	0 ... 10V, $\pm 5V$, $\pm 10V$, $\pm 2.5V$		
Resolution	13 Bit		
Start AD conversion	DC-synchron, SM-synchron		
Conversion time	580 μs (if all channels are enabled)		
Internal resistance	> 1M Ω		
Limit frequency input filter	typically 1 kHz		
Measuring error	< $\pm 0.4\%$, typically < $\pm 0.2\%$ of final value		
Baud rate	100 Mbit/s		
Controller	ASIC ET1200		
E-bus port	10-pin system plug in side wall		
Term. module	not required		
Connection IO/Power	Connector 36-pole		
Voltage supply	24V DC -20% +25%		
E-bus load	190mA		
Part no.	00C6CC1-1600		
Approvals			

9.4 AI4-I - 12 Bit (CoE)

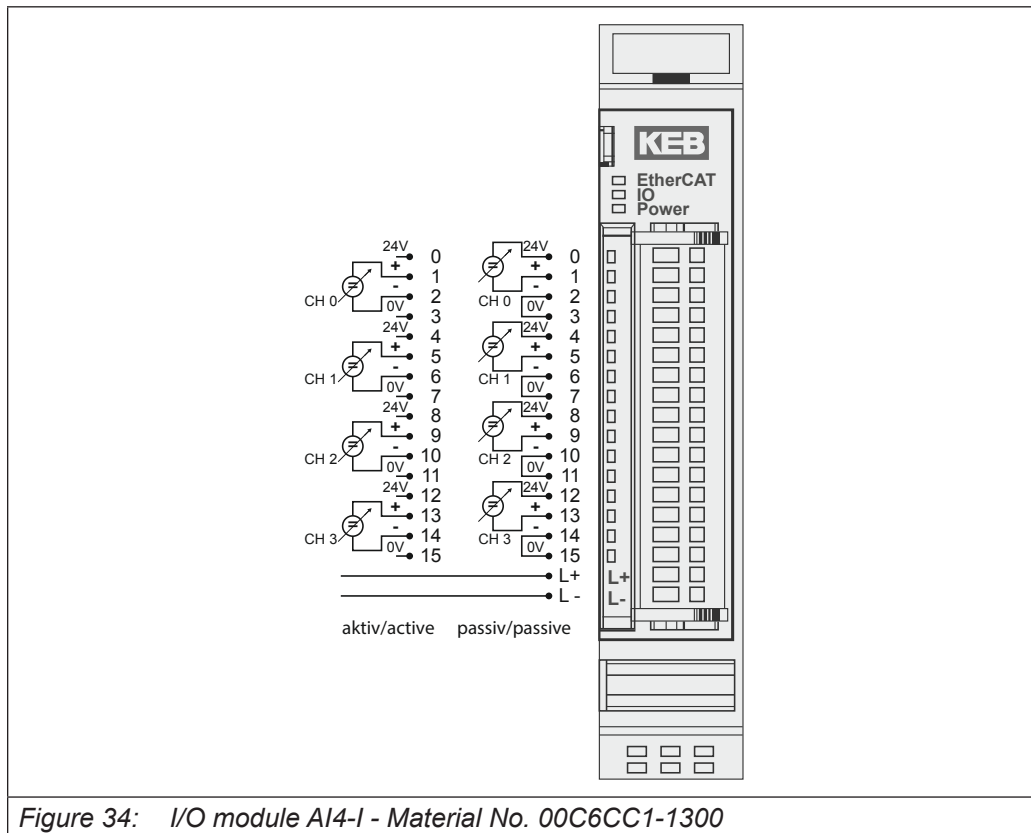

Figure 34: I/O module AI4-I - Material No. 00C6CC1-1300

Terminals

The 24V connection is used to supply the encoders.

Power is supplied to the module through the E-bus connector.



The module 00C6CC1-1300 KEB Remote I/O AI4-I 12Bit (CoE) is the non-compatible successor of the module 00C6CC1-0100 KEB Remote I/O AI4-I 12Bit.

The module is ETG compliant.

There are changes in the control program of the EtherCAT master necessary, if the module 00C6CC1-0100 KEB Remote I/O AI4-I 12Bit is to be replaced by the module 00C6CC1-1300 KEB Remote I/O AI4-I 12Bit (CoE).

9.4.1 Status LEDs

9.4.1.1 LED „EtherCAT Run“

The LED labelled „EtherCAT Run“ indicates the state of the EtherCAT ASIC.

State	LED, flash code	Explanation
init	Off	Initialising, no data exchange
Pre-Op	Off/green, 1:1	Pre-operational, no data exchange
Safe-Op	Off/green, 5:1	Safe operation, inputs readable
Op	Green, on	Operational, unrestricted data exchange

9.4.1.2 „IO“ LED

The LED labelled "IO" indicates the state of the module's I/Os.

State	LED, flash code	Explanation
OK	Green, on	No error
Error	Off	Malfunction of module if E-bus LED = On Inoperative if E-bus LED = Off
	Red, 4 x	EtherCat watchdog control
	Red, 7 x	Configuration error (E-Bus in Pre-Op state), number of process data differs from that in the module
Defective	Red, on	Module defective

9.4.1.3 „Power“ LED

The LED labelled "Power" indicates the state of the I/O encoder supply of the I/O module.

State	LED, flash code	Explanation
On	Green, on	24 VDC supply available
Off	Off	24 VDC supply not available

9.4.1.4 LED „Channel“

The "Channel" LEDs display the status of the respective channel.

State	LED, flash code	Explanation
On	Green, on	Channel enabled
Off	Off	Channel disabled
Error	Red, 1x	Current > 20.5mA
	Red, 2x	Current < 3.5mA (4...20mA mode)

9.4.2 Function

The AI4-I module has 4 analog current signal inputs. The measuring range can be set separately for every channel, i.e. either 0 to 20 mA or 4 to 20 mA.

9.4.3 Analog inputs

The digitized input values can be found in the following variables:

Variable	Data type	Explanation
AnalogInputn	INT	Measured value of channel n (n= 0...3)

9.4.4 Measured value

Current mode 0-20mA

Current [mA]	Value [Hex]
0	0x0
10	0x7FFF
20	0xFFFF

Current mode 4-20mA

Current [mA]	Value [Hex]
4	0x0
12	0x7FFF
20	0xFFFF

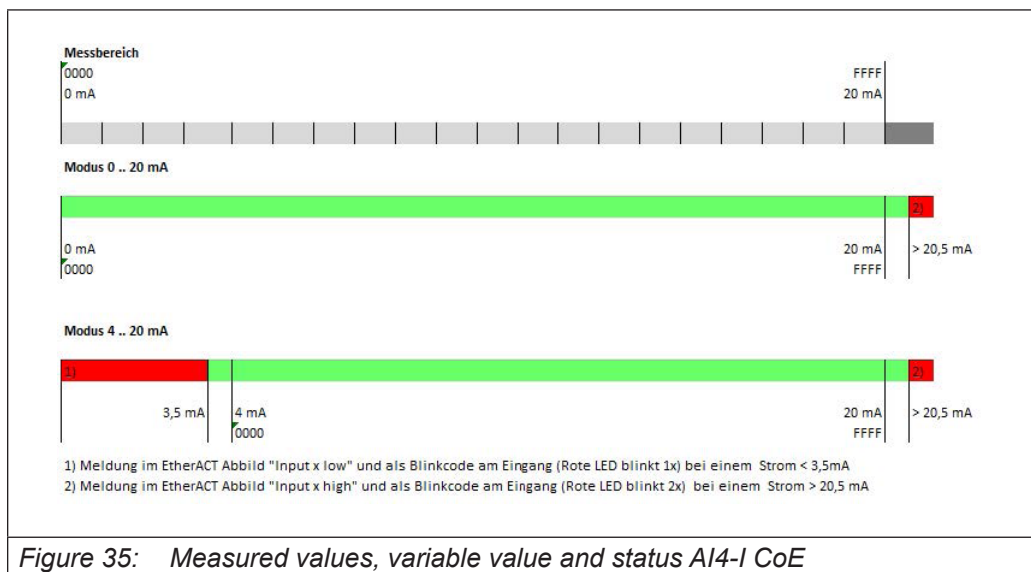

Figure 35: Measured values, variable value and status AI4-I CoE

9.4.5 Adjust options

The conversion of the analog values can be DC-synchron (Distributed Clocks) or SM-synchron (Sync Manager).

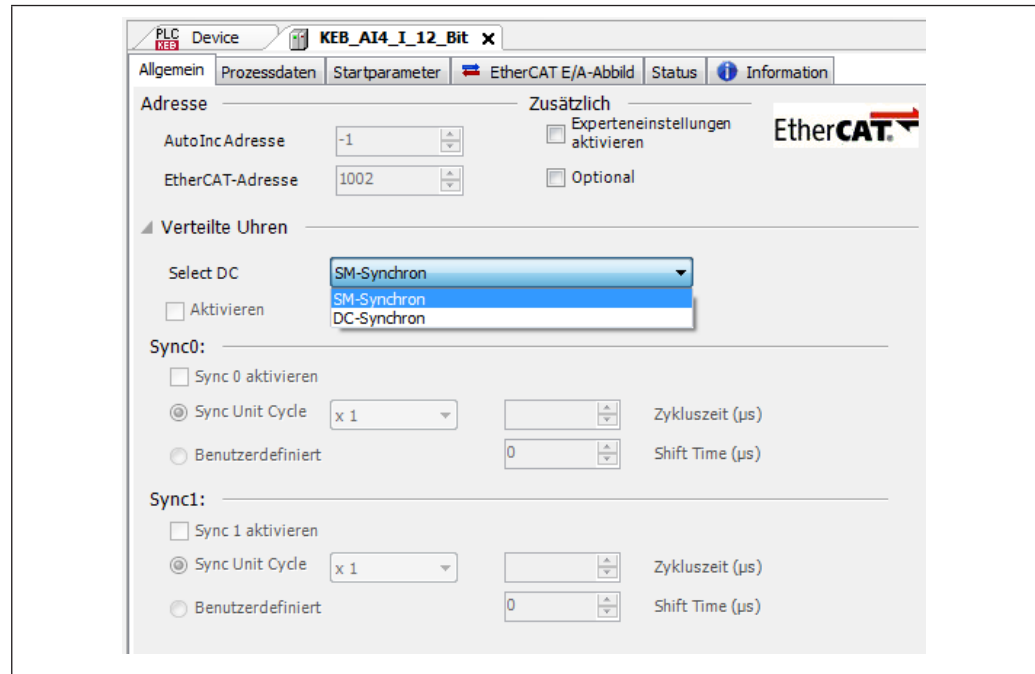

Figure 36: Adjust options

The input values and the module status are accessed via process data objects, which are mapped in variables in the control program of the EtherCAT master.

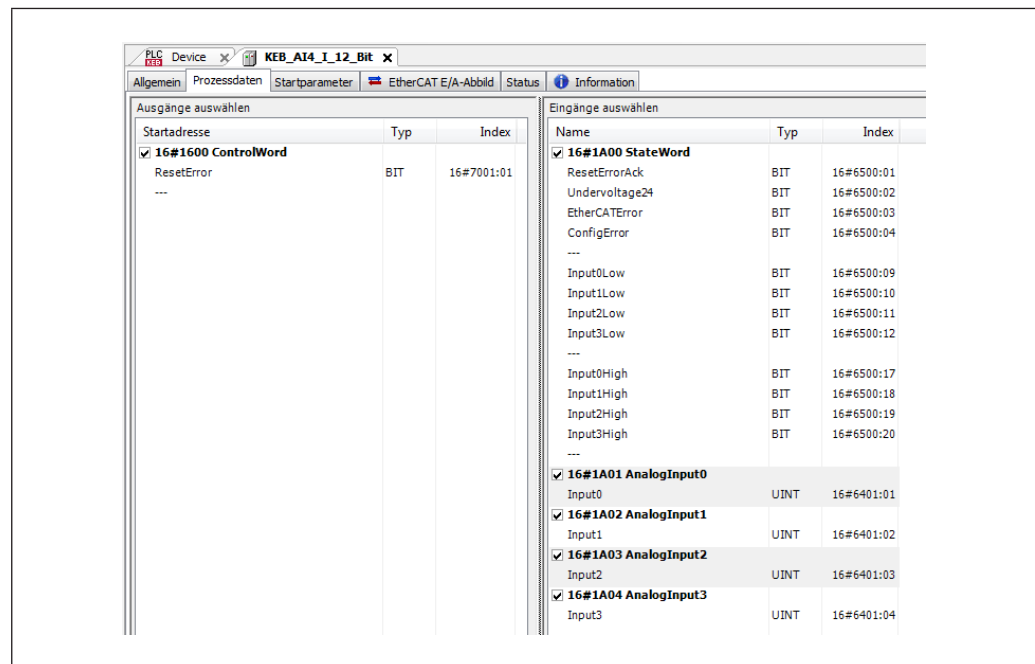

Figure 37: Adjust options

Service data objects are configured for information and settings.

Settings for the AI4-I 12Bit module, such the features of the individual inputs, can already be made offline in the configurator under "Start parameters". Then these are executed by the EtherCAT master during startup.

With the SDO transfer module available for the EtherCAT master, it is also possible to make runtime settings.

Press the "Add..." button, select the object and set the desired value.

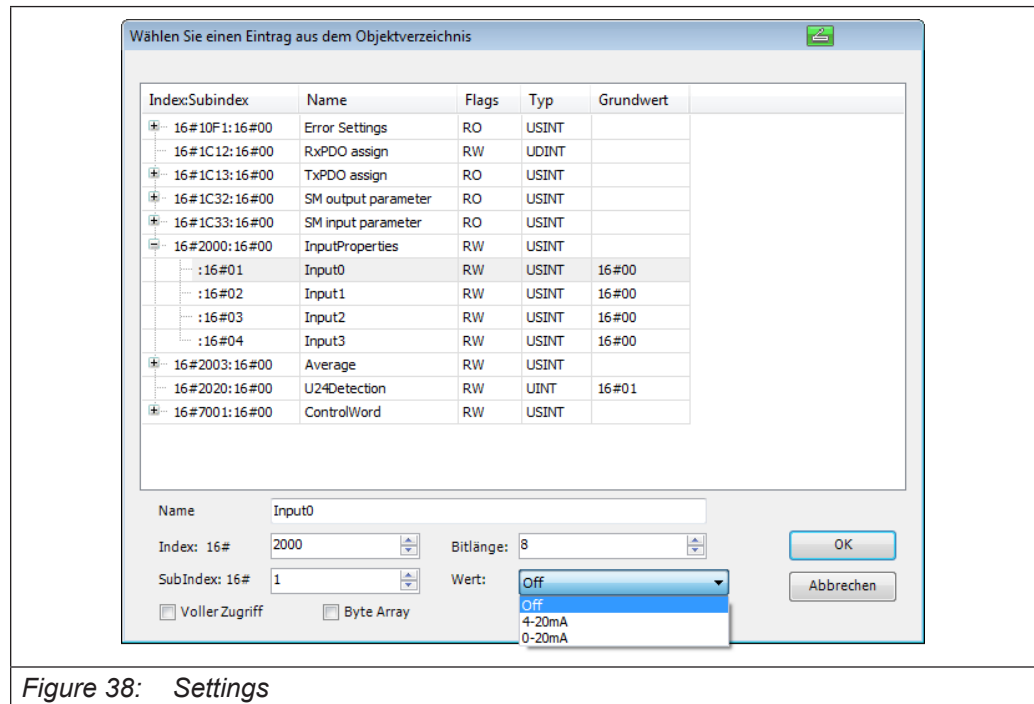

Figure 38: Settings

9.4.6 Options

The following options can be set:

Name	Value	Explanation
InputProperties	0	Off (default)
	5	4-20mA
	6	-20mA
Average	n=1...255	Inputn= Average value after n cycles (default=1)

9.4.7 StateWord

The status word contains messages about the state of the module:

Bit	Name	Explanation
0	ResetErrorAck	Acknowledge for "Reset Error" in Module Control
1	Undervoltage24	Supply of passive sensors < 19V (no error, only info)
2	EtherCATError	Sync Manager Watchdog
3	ConfigError	Mismatch of Sync Manager's quantity structure
4-7		not used
8	Input0low	Current at 4-20mA < 3.5mA
9	Input1low	Current at 4-20mA < 3.5mA
10	Input2low	Current at 4-20mA < 3.5mA
11	Input3low	Current at 4-20mA < 3.5mA
12-15		not used
16	Input0high	Current > 20.5mA
17	Input1high	Current > 20.5mA
18	Input2high	Current > 20.5mA
19	Input3high	Current > 20.5mA
20-31	-	not used

9.4.8 Analog inputs

The digitized input values can be found in the following variables:

Variable	Data type	Explanation
AnalogInputn	INT	Measured value of channel n (n= 0...3)

9.4.9 ControlWord

The control word contains a bit for error acknowledgement.

Bit	Name	Explanation
0	ResetError	0 -> Errors remain active, 1 -> Error is reset (error cause removed)
1-15	-	not used



9.4.10 Object Dictionary

Index	Name	Type	Default	Min Max	A c - cess
1000	Device Typ	UINT32	0x40191		RO
1001	Error Register	UINT8			RO
1008	Device Name	String	A14-I 12 Bit		RO
1009	Hardware Version	String	1.00		RO
100A	Software Version	String	1.00		RO
1018	Identity Object	Array			
1018, 0	Number of Entries	UINT8	4		RO
1018, 1	Vendor Id	UINT32	0x0048554B		RO
1018, 2	Product Code	UINT32	185339		RO
1018, 3	Revision Number	UINT32	1		RO
1018, 4	Serial Number	UINT32			RO
2000	Analog Input Properties	Array			
2000, 0	Number of Entries	UINT8	4		RO
2000, 1	Input 0	UINT8	Off	Off (0), 4-20mA (5), 0-20mA (6)	RW
2000, 2	Input 1	UINT8	Off	Off (0), 4-20mA (5), 0-20mA (6)	RW
2000, 3	Input 2	UINT8	Off	Off (0), 4-20mA (5), 0-20mA (6)	RW
2000, 4	Input 3	UINT8	Off	Off (0), 4-20mA (5), 0-20mA (6)	RW
2003	Input Average	Array			
2003, 0	Number of Entries	UINT8	4		RO
2003, 1	Input 0 Average	UINT8	1	1...255	RW
2003, 2	Input 1 Average	UINT8	1	1...255	RW
2003, 3	Input 2 Average	UINT8	1	1...255	RW
2003, 4	Input 3 Average	UINT8	1	1...255	RW
6401	Analog Input	Array			
6401, 0	Number of Entries	UINT8	4		RO
6401, 1	Analog Input 0	UINT16			RO P
6401, 2	Analog Input 1	UINT16			RO P

6401, 3	Analog Input 2	UINT16			RO P
6401, 4	Analog Input 3	UINT16			RO P
6500	StateWord	Array			
6500, 0	Number of Entries	UINT8	32		RO
6500, 1	ResetErrorAck	BOOL			RO P
6500, 2	Undervoltage24	BOOL			RO P
6500, 3	EtherCAT Error	BOOL			RO P
6500, 4	ConfigError	BOOL			RO P
6500, 5...8	-	BOOL			RO P
6500, 9	Input 0 low	BOOL			RO P
6500, 10	Input 1 low	BOOL			RO P
6500, 11	Input 2 low	BOOL			RO P
6500, 12	Input 3 low	BOOL			RO P
6500, 13...16	-	BOOL			RO P
6500, 17	Input 0 high	BOOL			RO P
6500, 18	Input 1 high	BOOL			RO P
6500, 19	Input 2 high	BOOL			RO P
6500, 20	Input 3 high	BOOL			RO P
6500, 21...32	-	BOOL			RO P
6500, 1	ResetErrorAck	BOOL			RO P
6500, 3	EtherCAT Error	BOOL			RO P
6500, 4	ConfigError	BOOL			RO P
7001	Module Control	Array			
7001, 0	Number of Entries	UINT8	1		RO
7001, 1	Reset Error	BOOL			RW P

RO=Read only, RW= Read/Write, P=Process image

9.4.11 Technical data

Analog inputs	4		
Measuring range	0 ...20mA, 4...20mA (limit value 20mA)		
Resolution	12 Bit		
Start AD conversion	DC-synchron, SM-synchron		
Conversion time	235µs (if all channels are enabled)		
Internal resistance	< 300Ω		
Limit frequency input filter	< 100kHz		
Measuring error	< ±0.5%, typically < ±0.4% of final value		
Baud rate	100 Mbit/s		
Controller	ASIC ET1200		
E-bus port	10-pin system plug in side wall		
Term. module	not required		
Connection IO/Power	Connector 18-pole		
Voltage supply	24V DC -20% +25%		
E-bus load	180mA		
Part no.	00C6CC1-1300		
Approvals			

9.5 AI8-I - 12 Bit (CoE)

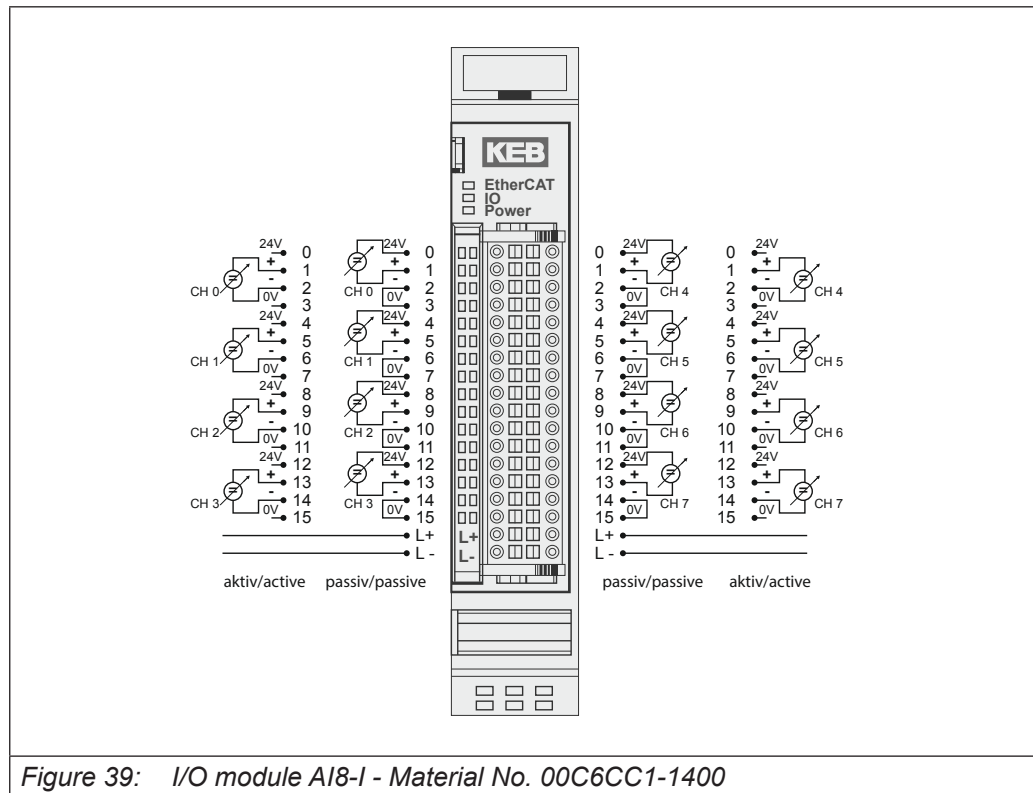

Figure 39: I/O module AI8-I - Material No. 00C6CC1-1400

Terminals

The 24V connection is used to supply the encoders.

Power is supplied to the module through the E-bus connector.



The module 00C6CC1-1400 KEB Remote I/O AI8-I 12Bit (CoE) is the non-compatible successor of the module 00C6CC1-0200 KEB Remote I/O AI8-I 12Bit.

The module is ETG compliant.

There are changes in the control program of the EtherCAT master necessary, if the module 00C6CC1-0200 KEB Remote I/O AI8-I 12Bit is to be replaced by the module 00C6CC1-1400 KEB Remote I/O AI8-I 12Bit (CoE).

9.5.1 Status LEDs

9.5.1.1 LED „EtherCAT Run“

The LED labelled „EtherCAT Run“ indicates the state of the EtherCAT ASIC.

State	LED, flash code	Explanation
init	Off	Initialising, no data exchange
Pre-Op	Off/green, 1:1	Pre-operational, no data exchange
Safe-Op	Off/green, 5:1	Safe operation, inputs readable
Op	Green, on	Operational, unrestricted data exchange

9.5.1.2 „IO“ LED

The LED labelled "IO" indicates the state of the module's I/Os.

State	LED, flash code	Explanation
OK	Green, on	No error
Error	Off	Malfunction of module if E-bus LED = On Inoperative if E-bus LED = Off
	Red, 4 x	EtherCat watchdog control
	Red, 7 x	Configuration error (E-Bus in Pre-Op state), number of process data differs from that in the module
Defective	Red, on	Module defective

9.5.1.3 „Power“ LED

The LED labelled "Power" indicates the state of the I/O encoder supply of the I/O module.

State	LED, flash code	Explanation
On	Green, on	24 VDC supply available
Off	Off	24 VDC supply not available

9.5.1.4 LED „Channel“

The "Channel" LEDs display the status of the respective channel.

State	LED, flash code	Explanation
On	Green, on	Channel enabled
Off	Off	Channel disabled
Error	Red, 1x	Current > 20.5mA
	Red, 2x	Current < 3.5mA (4...20mA mode)

9.5.2 Function

The AI8-I module has 8 analog current signal inputs. The measuring range can be set separately for every channel, i.e. either 0 to 20 mA or 4 to 20 mA.

9.5.3 Analog inputs

The digitized input values can be found in the following variables:

Variable	Data type	Explanation
AnalogInputn	INT	MValue measured on channel n (n= 0...7)

9.5.4 Measured value

Current mode 0-20mA

Current [mA]	Value [Hex]
0	0x0
10	0x7FFF
20	0xFFFF

Current mode 4-20mA

Current [mA]	Value [Hex]
4	0x0
12	0x7FFF
20	0xFFFF

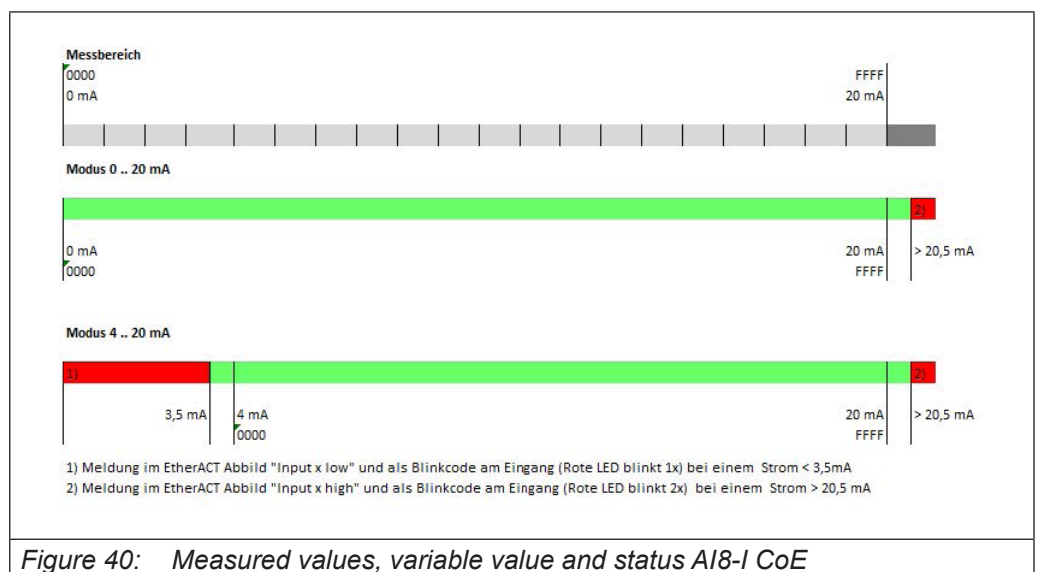

Figure 40: Measured values, variable value and status AI8-I CoE

9.5.5 Options

The following options can be set for each channel:

Name	Value	Explanation
InputProperties	0	Off (default)
	5	4-20mA
	6	0-20mA
Average	n=1...255	Inputn= Average value after n cycles (default=1)

9.5.6 StateWord

The status word (DWORD) contains messages about the state of the module:

Bit	Name	Explanation
0	ResetErrorAck	Acknowledge for "Reset Error" in Module Control
1	Undervoltage24	Supply of passive sensors < 19V (no error, only info)
2	EtherCATErrror	Sync Manager Watchdog
3	ConfigError	Mismatch of Sync Manager's quantity structure
4-7		not used
8	Input0low	Current at 4-20mA < 3.5mA
9	Input1low	Current at 4-20mA < 3.5mA
10	Input2low	Current at 4-20mA < 3.5mA
11	Input3low	Current at 4-20mA < 3.5mA
12	Input4low	Current at 4-20mA < 3.5mA
13	Input5low	Current at 4-20mA < 3.5mA
14	Input6low	Current at 4-20mA < 3.5mA
15	Input7low	Current at 4-20mA < 3.5mA
16	Input0high	Current > 20.5mA
17	Input1high	Current > 20.5mA
18	Input2high	Current > 20.5mA
19	Input3high	Current > 20.5mA
20	Input4high	Current > 20.5mA
21	Input5high	Current > 20.5mA
22	Input6high	Current > 20.5mA
23	Input7high	Current > 20.5mA
24-31	-	not used

9.5.7 Analog inputs

The digitized input values can be found in the following variables:

Variable	Data type	Explanation
Inputn	INT	Value for channel n (n=0...7)

9.5.8 ControlWord

The control word contains a bit for error acknowledgement.

Bit	Name	Explanation
0	ResetError	0 -> Errors remain active, 1 -> Error is reset (error cause removed)
1-15	-	not used

9.5.9 Object Dictionary

Index	Name	Type	Default	Min Max	Access
1000	Device Typ	UINT32	0x40191		RO
1001	Error Register	UINT8			RO
1008	Device Name	String	A18-I 12 Bit		RO
1009	Hardware Version	String	1.00		RO
100A	Software Version	String	1.00		RO
1018	Identity Object	Array			
1018, 0	Number of Entries	UINT8	4		RO
1018, 1	Vendor Id	UINT32	0x0048554B		RO
1018, 2	Product Code	UINT32	185345		RO
1018, 3	Revision Number	UINT32	1		RO
1018, 4	Serial Number	UINT32			RO
2000	Analog Input Properties	Array			
2000, 0	Number of Entries	UINT8	8		RO
2000, 1	Input 0	UINT8	Off	Off (0), 4-20mA (5), 0-20mA (6)	RW
2000, 2	Input 1	UINT8	Off	Off (0), 4-20mA (5), 0-20mA (6)	RW
2000, 3	Input 2	UINT8	Off	Off (0), 4-20mA (5), 0-20mA (6)	RW
2000, 4	Input 3	UINT8	Off	Off (0), 4-20mA (5), 0-20mA (6)	RW
2000, 5	Input 4	UINT8	Off	Off (0), 4-20mA (5), 0-20mA (6)	RW
2000, 6	Input 5	UINT8	Off	Off (0), 4-20mA (5), 0-20mA (6)	RW



2000, 7	Input 6	UINT8	Off	Off (0), 4-20mA (5), 0-20mA (6)	RW
2000, 8	Input 7	UINT8	Off	Off (0), 4-20mA (5), 0-20mA (6)	RW
2003	Input Average	Array			
2003, 0	Number of Entries	UINT8	8		RO
2003, 1	Input 0 Average	UINT8	1	1...255	RW
2003, 2	Input 1 Average	UINT8	1	1...255	RW
2003, 3	Input 2 Average	UINT8	1	1...255	RW
2003, 4	Input 3 Average	UINT8	1	1...255	RW
2003, 5	Input 4 Average	UINT8	1	1...255	RW
2003, 6	Input 5 Average	UINT8	1	1...255	RW
2003, 7	Input 6 Average	UINT8	1	1...255	RW
2003, 8	Input 7 Average	UINT8	1	1...255	RW
6401	Analog Input	Array			
6401, 0	Number of Entries	UINT8	8		RO
6401, 1	Analog Input 0	UINT16			RO P
6401, 2	Analog Input 1	UINT16			RO P
6401, 3	Analog Input 2	UINT16			RO P
6401, 4	Analog Input 3	UINT16			RO P
6401, 5	Analog Input 4	UINT16			RO P
6401, 6	Analog Input 5	UINT16			RO P
6401, 7	Analog Input 6	UINT16			RO P
6401, 8	Analog Input 7	UINT16			RO P
6500	StateWord	Array			
6500, 0	Number of Entries	UINT8	32		RO
6500, 1	ResetErrorAck	BOOL			RO P
6500, 3	EtherCAT Error	BOOL			RO P
6500, 4	ConfigError	BOOL			RO P
6500, 5...8	-	BOOL			RO P
6500, 9	Input 0 low	BOOL			RO P
6500, 10	Input 1 low	BOOL			RO P
6500, 11	Input 2 low	BOOL			RO P
6500, 12	Input 3 low	BOOL			RO P
6500, 13	Input 4 low	BOOL			RO P

ANALOG KEB I/O MODULES

6500, 14	Input 5 low	BOOL			RO P
6500, 15	Input 6 low	BOOL			RO P
6500, 16	Input 7 low	BOOL			RO P
6500, 17	Input 0 high	BOOL			RO P
6500, 18	Input 1 high	BOOL			RO P
6500, 19	Input 2 high	BOOL			RO P
6500, 20	Input 3 high	BOOL			RO P
6500, 21	Input 4 high	BOOL			RO P
6500, 22	Input 5 high	BOOL			RO P
6500, 23	Input 6 high	BOOL			RO P
6500, 24	Input 7 high	BOOL			RO P
6500, 25...32	-	BOOL			RO P
6500, 1	ResetErrorAck	BOOL			RO P
6500, 3	EtherCAT Error	BOOL			RO P
6500, 4	ConfigError	BOOL			RO P
7001	Module Control	Array			
7001, 0	Number of Entries	UINT8	1		RO
7001, 1	Reset Error	BOOL			RW P

RO=Read only, RW= Read/Write, P=Process image

9.5.10 Technical data

Analog inputs	8		
Measuring range	0 ...20mA, 4...20mA (limit value 20mA)		
Resolution	12 Bit		
Start AD conversion	DC-synchron, SM-synchron		
Conversion time	290µs (if all channels are enabled)		
Internal resistance	< 300Ω		
Limit frequency input filter	< 100kHz		
Measuring error	< ±0.5%, typically < ±0.4% of final value		
Baud rate	100 Mbit/s		
Controller	ASIC ET1200		
E-bus port	10-pin system plug in side wall		
Term. module	not required		
Connection IO/Power	Connector 36-pole		
Voltage supply	24V DC -20% +25%		
E-bus load	190mA		
Part no.	00C6CC1-1400		
Approvals			

9.6 AI4-Pt/Ni/TC -16 Bit (CoE)

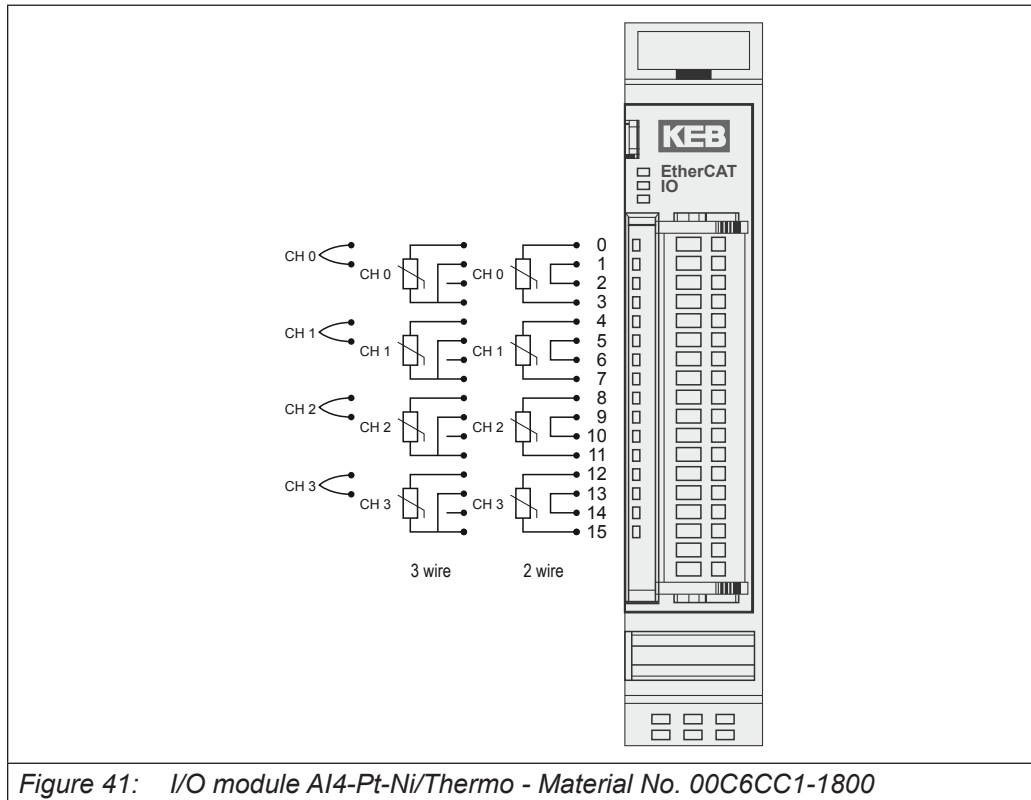

Figure 41: I/O module AI4-Pt/Ni/Thermo - Material No. 00C6CC1-1800

Terminals

The module needs no separate 24V connector. Power is supplied to the module through the E-bus connector.



The module 00C6CC1-1800 AI4 PT/Ni/Thermo 16Bit (CoE) is the incompatible successor of the following modules:

- | | |
|--------------|------------------------------------|
| 00C6CC1-0700 | KEB Remote I/O AI4 PT/Ni100 16Bit |
| 00C6CC1-0900 | KEB Remote I/O AI4 PT/Ni1000 16Bit |
| 00C6CC1-1100 | KEB Remote I/O AI4-TE 16Bit |

The module is ETG compliant.

There are changes in the control program of the EtherCAT master necessary, if the modules 00C6CC1-0700 KEB Remote I/O AI4 PT/Ni100 16Bit or 00C6CC1-0900 KEB Remote I/O AI4 PT/Ni1000 16Bit or 600C6CC1-1100 KEB Remote I/O AI4-TE 16Bit are to be replaced by the modules 00C6CC1-0700 KEB Remote I/O AI4 PT/Ni100 16Bit or 00C6CC1-0900 KEB Remote I/O AI4 PT/Ni1000 16Bit or 600C6CC1-1100 KEB Remote I/O AI4-TE 16Bit.

9.6.1 Status LEDs

9.6.1.1 LED „EtherCAT Run“

The LED labelled „EtherCAT Run“ indicates the state of the EtherCAT ASIC.

State	LED, flash code	Explanation
init	Off	Initialising, no data exchange
Pre-Op	Off/green, 1:1	Pre-operational, no data exchange
Safe-Op	Off/green, 5:1	Safe operation, inputs readable
Op	Green, on	Operational, unrestricted data exchange

9.6.1.2 „IO“ LED

The LED labelled "IO" indicates the state of the module's I/Os.

State	LED, flash code	Explanation
OK	Green, on	No error
Error	Off	Malfunction of module if E-bus LED = On Inoperative if E-bus LED = Off
	Red, 4 x	EtherCat watchdog control
	Red, 7 x	Configuration error (E-Bus in Pre-Op state), number of process data differs from that in the module
Defective	Red, on	Module defective

9.6.1.3 LED „Channel“

The "Channel" LEDs display the status of the respective channel.

State	LED, flash code	Explanation
On	Green, on	Channel enabled
Off	Off	Channel disabled
Error	Red 1x	Sensor low
	Red 2x	Sensor high



Information about operating mode Pt100/Ni100

In operating mode Pt100 and Ni100, the error message "Input High" is not output if no temperature sensor is connected. If the wiring is correct (2-wire connection with bridge or 3-wire connection), the errors are correctly detected/displayed.



Information about the operating mode thermocouple

- The error messages "Input Low" or "Input High" only indicate that the temperature value range has been exceeded or not reached.
- A short circuit ("Input Low") is not detected in the operating mode thermocouple (type J,K), because the thermoelectric voltage is very low that it does not matter whether it is short-circuited or not.
- A wire break is not detected, here the floating of the values in the module can lead to the message "Input High" or "Input Low".

9.6.2 Function

The module AI 4 PT/Ni/Thermo has 4 analog inputs for temperature sensors. The sensor type can be set channel by channel to millivolt encoder, Pt100, Pt1000, Ni100, Ni1000 (DIN43760) and thermocouple.

9.6.3 Measured value

The output of the measured value is in 0.1°C (default setting). Alternatively the output can be selected in ohm/volt or as raw value.

9.6.4 Adjust options

The conversion of the analog values can be DC-synchron (Distributed Clocks) or SM-synchron (Sync Manager).

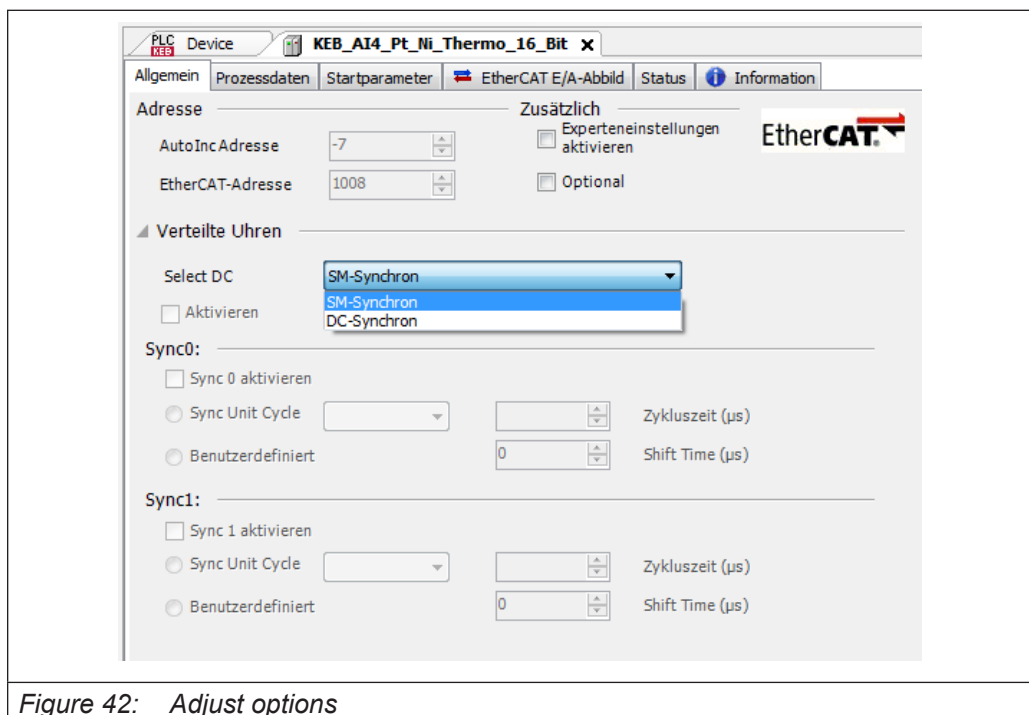

Figure 42: Adjust options

The input values and the module status are accessed via process data objects, which are mapped in variables in the control program of the EtherCAT master.

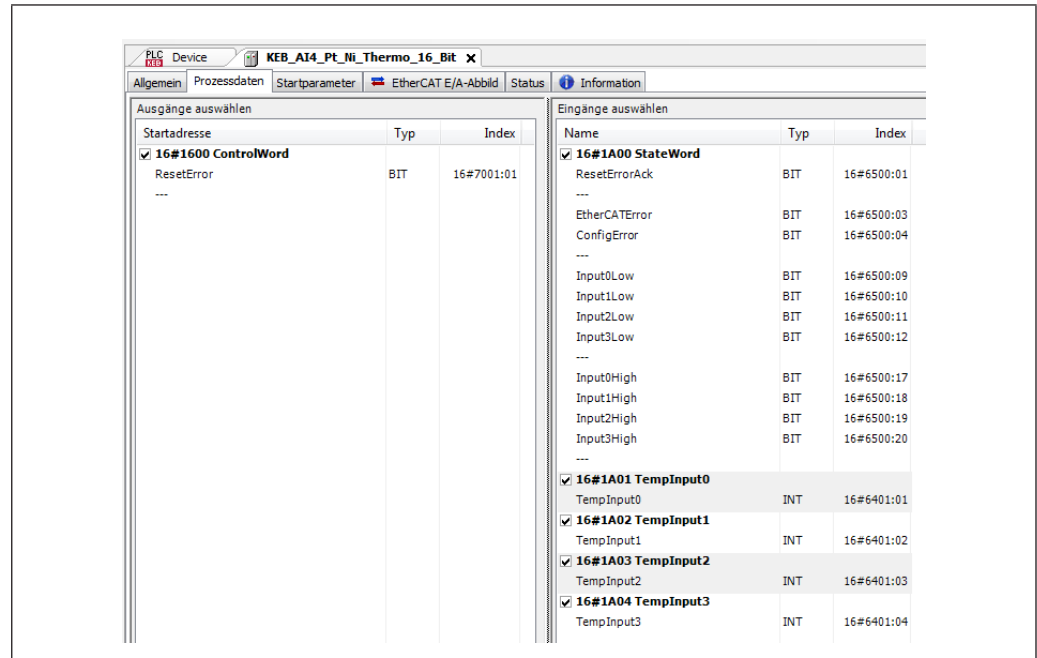

Figure 43: Adjust options

Service data objects are configured for information and settings.

Settings for the AI4-I 12Bit module, such the features of the individual inputs, can already be made offline in the configurator under "Start parameters". Then these are executed by the EtherCAT master during startup.

With the SDO transfer module available for the EtherCAT master, it is also possible to make runtime settings.

Press the "Add..." button, select the object and set the desired value.

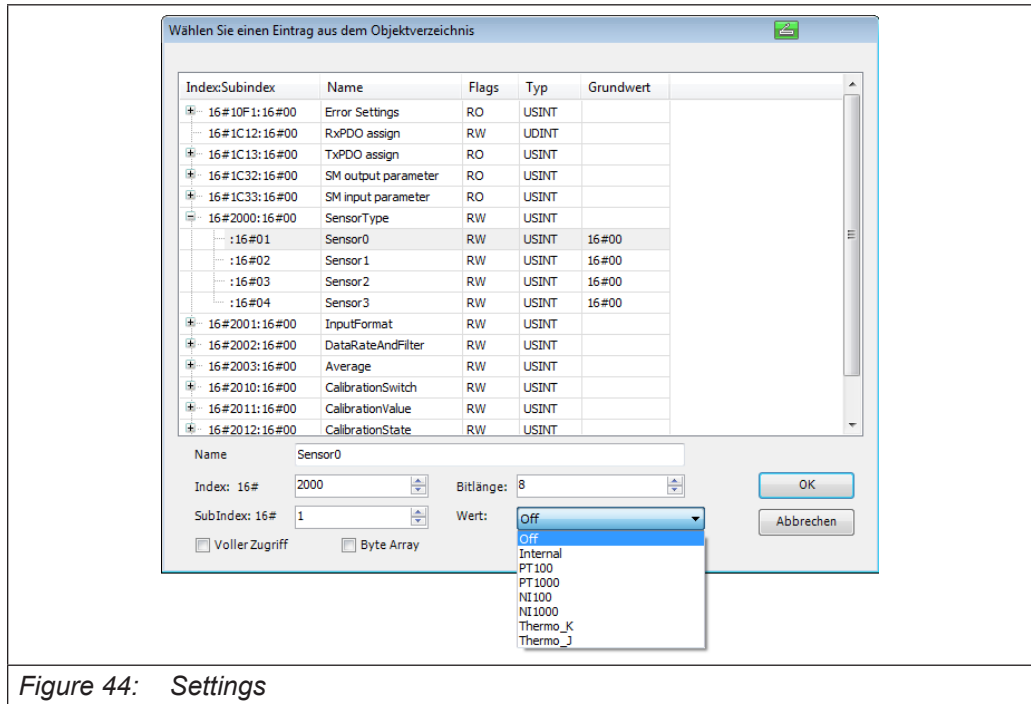

Figure 44: Settings

9.6.5 Options

The following options can be set:

Name	Value	Explanation
Sensor Type	0	Off (default)
	1	Internal (mV)
	2	Pt100
	3	Pt1000
	4	Ni100
	5	Ni1000 (DIN43760)
	6	Thermo K
	7	Thermo J
InputFormat	0	0,1 °C
	1	Ω / V
	2	Raw (raw value)
Data rate and filter	0	1000 measurements per second
	1	600 measurements per second
	2	330 measurements per second
	3	175 measurements per second
	4	90 measurements per second
	5	45 measurements per second
	6	20 measurements per second
	7	20 measurements per second + 50 & 60Hz filter
	8	20 measurements per second + 50Hz filter
	9	20 measurements per second + 60Hz filter
Average	n=1...255	Inputn= Average value after n cycles (default=1)

9.6.6 StateWord

The status word (DWORD) contains messages about the state of the module:

Bit	Name	Explanation
0	ResetErrorAck	Acknowledge for "Reset Error" in Module Control
1	-	not used
2	EtherCATErrror	Sync Manager Watchdog
3	ConfigError	Mismatch of Sync Manager's quantity structure
4-7	-	not used
8	Input0low	connected measured value in the wrong range
9	Input1low	connected measured value in the wrong range
10	Input2low	connected measured value in the wrong range
11	Input3low	connected measured value in the wrong range
12-15	-	not used
16	Input0high	connected measured value in the wrong range
17	Input1high	connected measured value in the wrong range
18	Input2high	connected measured value in the wrong range
19	Input3high	connected measured value in the wrong range
20-31	-	not used

9.6.7 Analog inputs

The digitized input values can be found in the following variables:

Variable	Data type	Explanation
TempInputn	INT	Value for channel n (n=0...3) in 0.1°C, Ω or 2μV

9.6.8 ControlWord

The control word contains a bit for error acknowledgement.

Bit	Name	Explanation
0	ResetError	0 -> Errors remain active, 1 -> Error is reset (error cause removed)
1-15	-	not used

9.6.9 Cold-junction compensation

Cold-junction compensation is performed automatically when thermocouples are used. The temperature is measured directly at the plug near the connections.

9.6.10 Calibration

A calibration by the end user is not intended for this module, the necessary calibrations are carried out after module production.

The calibration can only be carried out once, because the calibration values are permanently stored.

The objects available in the start parameters for calibration (2010:n; 2011:n and 2012:n) are for internal use only.

9.6.11 Object Dictionary

Index	Name	Type	Default	Min Max	Access
1000	Device Typ	UINT32	0x40191		RO
1001	Error Register	UINT8			RO
1008	Device Name	String	AI4_Pt/Ni/ Thermo		RO
1009	Hardware Version	String	1.00		RO
100A	Software Version	String	1.00		RO
1018	Identity Object	Array			
1018, 0	Number of Entries	UINT8	4		RO
1018, 1	Vendor Id	UINT32	0x0048554B		RO
1018, 2	Product Code	UINT32	185345		RO
1018, 3	Revision Number	UINT32	1		RO
1018, 4	Serial Number	UINT32			RO
2000	Sensor Type	Array			
2000, 0	Number of Entries	UINT8	4		RO
2000, 1	Sensor0	UINT8	Off	Off (0), Internal (1), PT100 (2), PT1000 (3), NI100 (4), NI1000 (5), Thermo_K (6), Thermo_J (7)	RW
2000, 2	Sensor1	UINT8	Off	Off, Internal, PT100, PT1000, NI100, NI1000, Thermo_K, Thermo_J	RW
2000, 3	Sensor2	UINT8	Off	Off, Internal, PT100, PT1000, NI100, NI1000, Thermo_K, Thermo_J	RW

2000, 4	Sensor3	UINT8	Off	Off, Internal, PT100, PT1000, NI100, NI1000, Thermo_K, Thermo_J	RW
2001	Input Format	Array			
2001, 0	Number of Entries	UINT8	4		RO
2001, 1	Input0Format	UINT8	0.1 °C	0.1°C (0), Ω / V (1) Raw (2)	RW
2001, 2	Input1Format	UINT8	0.1 °C	0.1°C, Ω / V Raw	RW
2001, 3	Input2Format	UINT8	0.1 °C	0.1°C, Ω / V Raw	RW
2001, 4	Input3Format	UINT8	0.1 °C	0.1°C, Ω / V Raw	RW
2002	Data RateAndFilter	Array			
2002, 0	Number of Entries	UINT8	4		
2002, 1	Input0DataRateAnd Filter	UINT8	20 PLC	1000 PLC (0) 600 PLC (1) 330 PLC (2) 175 PLC (3) 90 PLC (4) 45 PLC (5) 20 PLC (6) 20 PLC+50&60Hz (7) 20 PLC + 50Hz (8) 20 PLC + 60 Hz (9)	RO



ANALOG KEB I/O MODULES

2002, 2	Input1DataRateAndFilter	UINT8	20 PLC	1000 PLC 600 PLC 330 PLC 175 PLC 90 PLC 45 PLC 20 PLC 20 PLC+50&60Hz 20 PLC + 50Hz 20 PLC + 60 Hz	RO
2002, 3	Input2DataRateAndFilter	UINT8	20 PLC	1000 PLC 600 PLC 330 PLC 175 PLC 90 PLC 45 PLC 20 PLC 20 PLC+50&60Hz 20 PLC + 50Hz 20 PLC + 60 Hz	RO
2002, 4	Input3DataRateAndFilter	UINT8	20 PLC	1000 PLC 600 PLC 330 PLC 175 PLC 90 PLC 45 PLC 20 PLC 20 PLC+50&60Hz 20 PLC + 50Hz 20 PLC + 60 Hz	RO
2003	Average	Array			
2003, 0	Number of Entries	UINT8	4		RO
2003, 1	Input 0 Average	UINT8	1	1...255	RW
2003, 2	Input 1 Average	UINT8	1	1...255	RW
2003, 3	Input 2 Average	UINT8	1	1...255	RW
2003, 4	Input 3 Average	UINT8	1	1...255	RW
6401	Analog Input	Array			
6401, 0	Number of Entries	UINT8	4		RO
6401, 1	Analog Input 0	UINT16			RO P
6401, 2	Analog Input 1	UINT16			RO P
6401, 3	Analog Input 2	UINT16			RO P
6500	StateWord	Array			RO P

6500, 0	Number of Entries	UINT8	32		RO P
6500, 1	ResetErrorAck	BOOL			RO P
6500, 2	-	BOOL			RO P
6500, 3	EtherCAT Error	BOOL			RO P
6500, 4	ConfigError	BOOL			RO P
6500, 5...8	-	BOOL			RO P
6500, 9	Input 0 low	BOOL			RO P
6500, 10	Input 1 low	BOOL			RO P
6500, 11	Input 2 low	BOOL			RO P
6500, 12	Input 3 low	BOOL			RO P
6500, 13...16	-	BOOL			RO P
6500, 17	Input 0 high	BOOL			RO P
6500, 18	Input 1 high	BOOL			RO P
6500, 19	Input 2 high	BOOL			RO P
6500, 20	Input 3 high	BOOL			RO P
6500, 21...32	-	BOOL			RO P
7001	Module Control	Array			
7001, 0	Number of Entries	UINT8	1		RO
7001, 1	Reset Error	BOOL			RW P

RO=Read only, RW= Read/Write, P=Process image

9.6.12 Technical data

Analog inputs	4
Resolution	16 Bit
Limit frequency input filter	0.33Hz (typically)
Conversion time	50ms (adjustable)
Thermocouple	
Sensor types	J,K, mV (internal)
Cold-junction compensation	yes
Measuring range type K	200°C...+1372°C
Measuring range type J	-50°C...+760°C
Measuring range mV	-40 ... +65 mV
Measuring error	<±0.54% (of the upper range value)
Temperature drift	<±50ppm (of the upper range value)
Pt1000 / Ni1000 DIN43760	
Measuring range Pt	-75°C...+670°C
Measuring range Ni	-60°C...+250°C
Input resistance	700...3200
Measuring current	0.1mA (typically)
Measuring error	<±1.0°C (at 25°C ambient temperature)
Baud rate	100 Mbit/s
Controller	ASIC ET1200
E-bus port	10-pin system plug in side wall
Term. module	not required
Connection IO/Power	Connector 18-pole
Voltage supply	no
E-bus load	170mA
Part no.	00C6CC1-1800
Approvals	  

9.7 AI8-Pt/Ni/TC - 16 Bit (CoE)

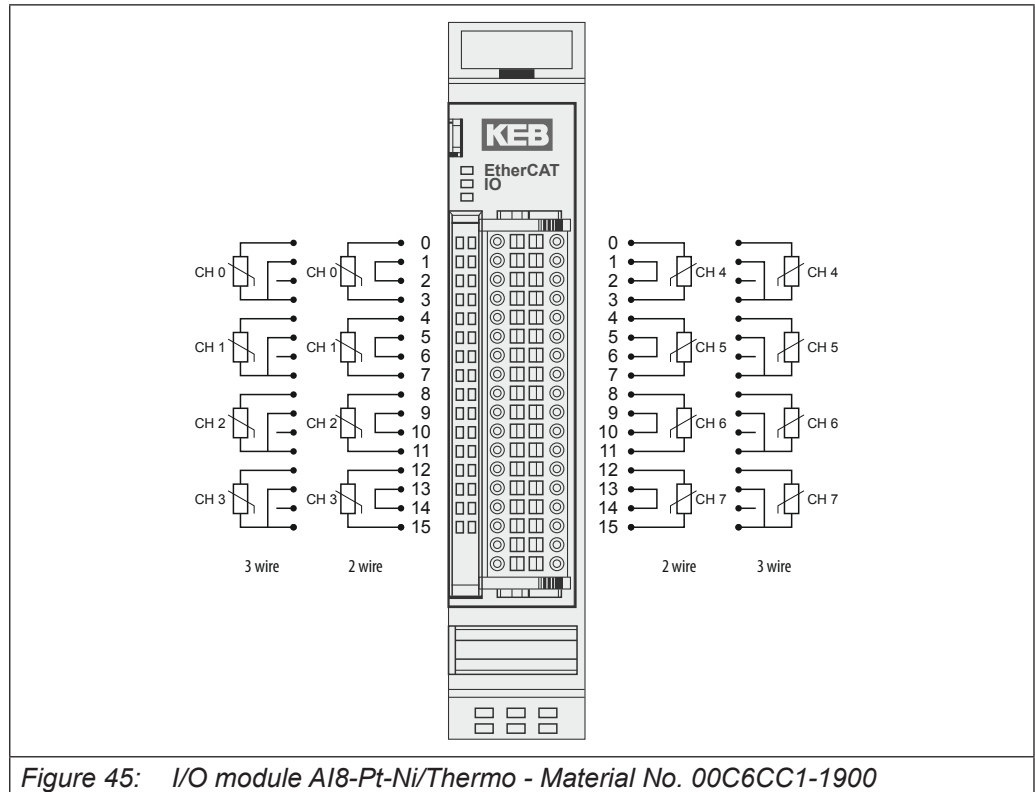

Figure 45: I/O module AI8-Pt-Ni/Thermo - Material No. 00C6CC1-1900

Terminals

The module needs no separate 24V connector. Power is supplied to the module through the E-bus connector.



The module 00C6CC1-1900 AI8 PT/Ni/Thermo 16Bit (CoE) is the incompatible successor of the following modules:

00C6CC1-0800 KEB Remote I/O AI8 PT/Ni100 16Bit

00C6CC1-1000 KEB Remote I/O AI8 PT/Ni1000 16Bit

00C6CC1-1200 KEB Remote I/O AI8-TE 16Bit

The module is ETG compliant.

There are changes in the control program of the EtherCAT master necessary, if the modules 00C6CC1-0800 KEB Remote I/O AI8 PT/Ni100 16Bit or 00C6CC1-1000 KEB Remote I/O AI8 PT/Ni1000 16Bit or 00C6CC1-1200 KEB Remote I/O AI8-TE 16Bit are to be replaced by the module 00C6CC1-1900 AI8 PT/Ni/Thermo 16Bit (CoE).

9.7.1 Status LEDs

9.7.1.1 LED „EtherCAT Run“

The LED labelled „EtherCAT Run“ indicates the state of the EtherCAT ASIC.

State	LED, flash code	Explanation
init	Off	Initialising, no data exchange
Pre-Op	Off/green, 1:1	Pre-operational, no data exchange
Safe-Op	Off/green, 5:1	Safe operation, inputs readable
Op	Green, on	Operational, unrestricted data exchange

9.7.1.2 „IO“ LED

The LED labelled "IO" indicates the state of the module's I/Os.

State	LED, flash code	Explanation
OK	Green, on	No error
Error	Off	Malfunction of module if E-bus LED = On
		Inoperative if E-bus LED = Off
	Red, 4 x	EtherCat watchdog control
	Red, 7 x	Configuration error (E-Bus in Pre-Op state), number of process data differs from that in the module
Defective	Red, on	Module defective

9.7.1.3 LED „Channel“

The "Channel" LEDs display the status of the respective channel.

State	LED, flash code	Explanation
On	Green, on	Channel enabled
Off	Off	Channel disabled
Error	Red 1x	Sensor low
	Red 2x	Sensor high



Information about operating mode Pt100/Ni100

In operating mode Pt100 and Ni100, the error message "Input High" is not output if no temperature sensor is connected. If the wiring is correct (2-wire connection with bridge or 3-wire connection), the errors are correctly detected/displayed.



Information about the operating mode thermocouple

- The error messages "Input Low" or "Input High" only indicate that the temperature value range has been exceeded or not reached.
- A short circuit ("Input Low") is not detected in the operating mode thermocouple (type J,K), because the thermoelectric voltage is very low that it does not matter whether it is short-circuited or not.
- A wire break is not detected, here the floating of the values in the module can lead to the message "Input High" or "Input Low".

9.7.2 Function

The module AI4-Pt/Ni/TC has 4 analog inputs for temperature sensors. The sensor type can be set channel by channel to millivolt encoder, Pt100, Pt1000, Ni100, Ni1000 (DIN43760) and thermocouple.

9.7.3 Measured value

The output of the measured value is in 0.1°C (default setting). Alternatively the output can be selected in ohm/volt or as raw value.

9.7.4 Adjust options

The conversion of the analog values can be DC-synchron (Distributed Clocks) or SM-synchron (Sync Manager).

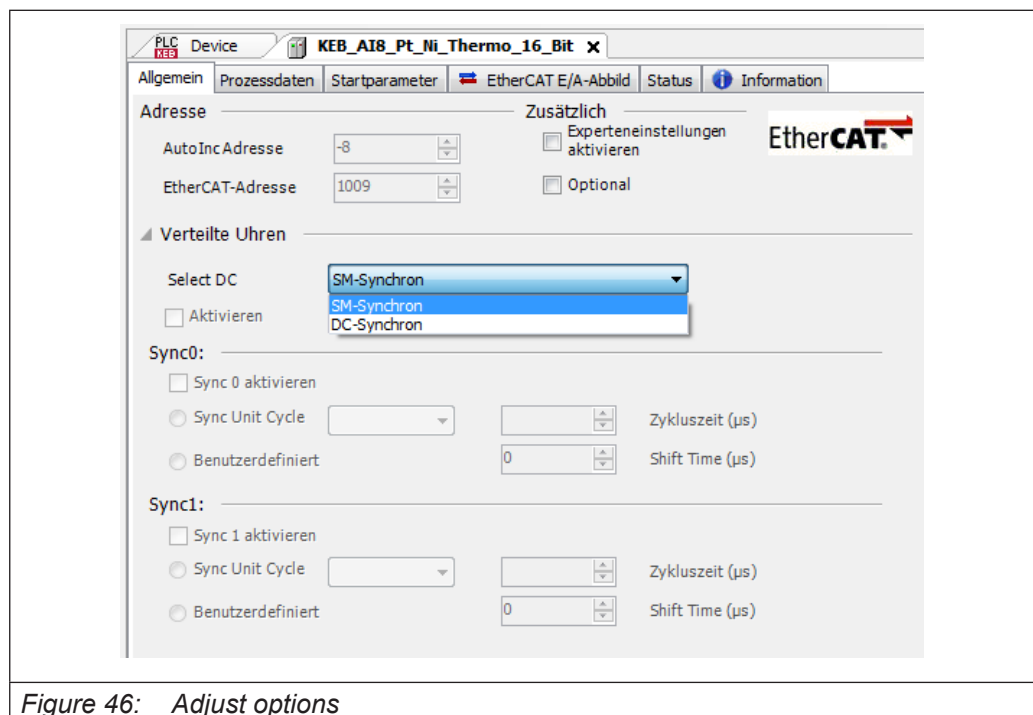

Figure 46: Adjust options

The input values and the module status are accessed via process data objects, which are mapped in variables in the control program of the EtherCAT master.

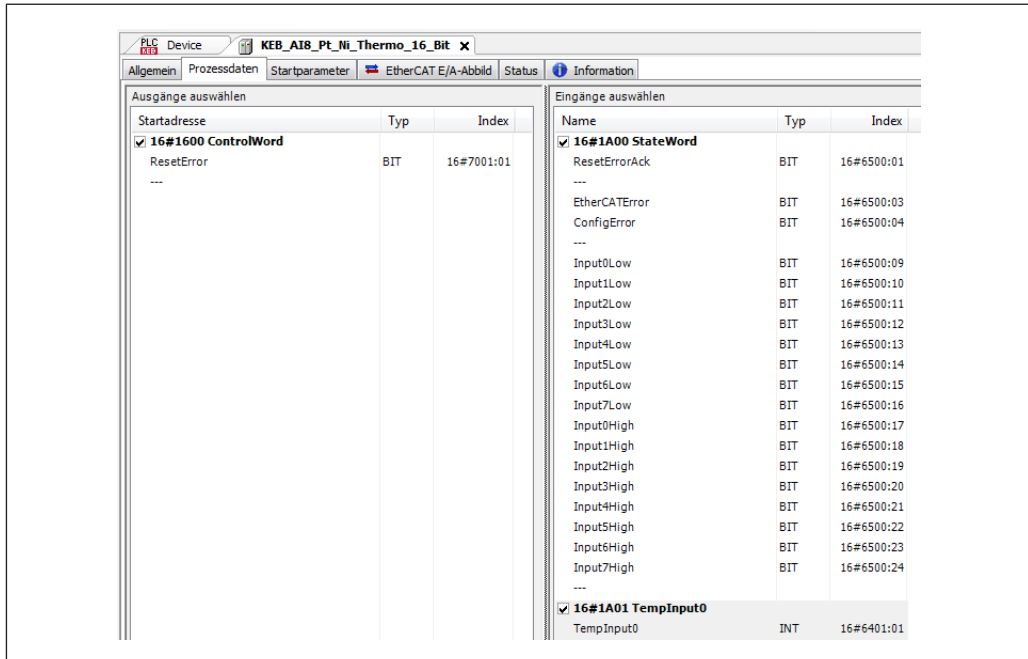

Figure 47: Adjust options

Service data objects are configured for information and settings.

Settings for the AI8-Pt/Ni/Thermo module, such the features of the individual inputs, can already be made offline in the configurator under "Start parameters". Then these are executed by the EtherCAT master during startup.

With the SDO transfer module available for the EtherCAT master, it is also possible to make runtime settings.

Press the "Add..." button, select the object and set the desired value.

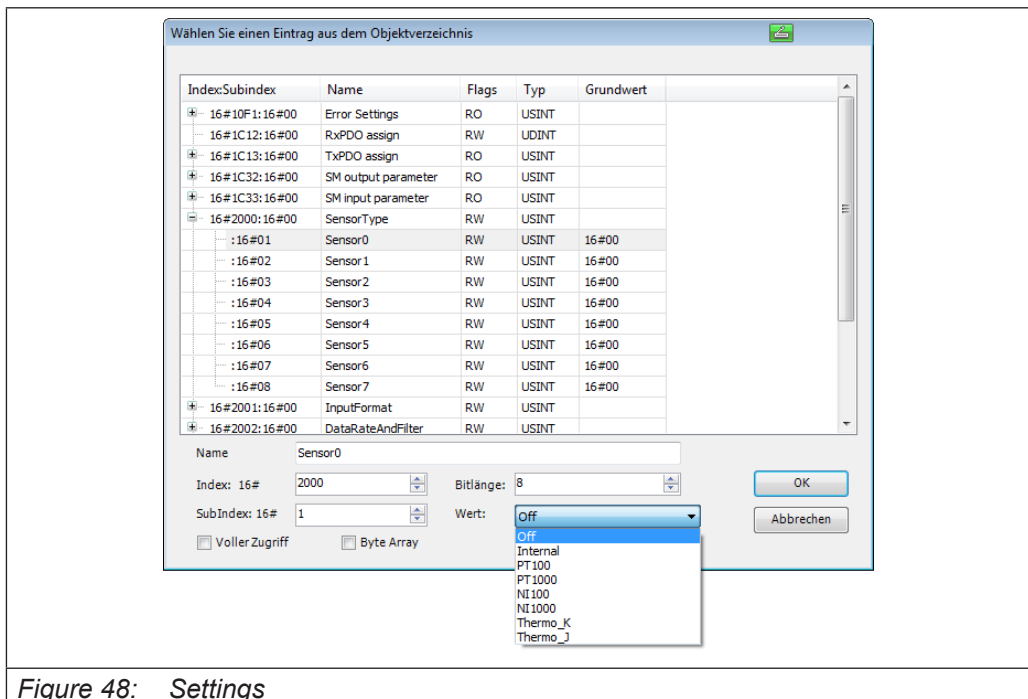

Figure 48: Settings

9.7.5 Options

The following options can be set:

Name	Value	Explanation
Sensor Type	0	Off (default)
	1	Internal (mV)
	2	Pt100
	3	Pt1000
	4	Ni100
	5	Ni1000 (DIN43760)
	6	Thermo K
	7	Thermo J
InputFormat	0	0,1 °C
Data rate and filter	1	Ω / V
	2	330 measurements per second
	0	1000 measurements per second
Average	1	600 measurements per second
	2	330 measurements per second
	3	175 measurements per second
	4	90 measurements per second
	5	45 measurements per second
	6	20 measurements per second
	7	20 measurements per second + 50 & 60Hz filter
	8	20 measurements per second + 50Hz filter
	9	20 measurements per second + 60Hz filter
	n=1...255	Inputn= Average value after n cycles (default=1)

9.7.6 StateWord

The state word (DWORD) contains messages about the state of the module:

Bit	Name	Explanation
0	ResetErrorAck	Acknowledge for "Reset Error" in Module Control
1	-	not used
2	EtherCATErrror	Sync Manager Watchdog
3	ConfigError	Mismatch of Sync Manager's quantity structure
4-7	-	not used
8	Input0low	connected measured value in the wrong range
9	Input1low	connected measured value in the wrong range
10	Input2low	connected measured value in the wrong range
11	Input3low	connected measured value in the wrong range
12	Input4low	connected measured value in the wrong range
13	Input5low	connected measured value in the wrong range
14	Input6low	connected measured value in the wrong range
15	Input7low	connected measured value in the wrong range
16	Input0high	connected measured value in the wrong range
17	Input1high	connected measured value in the wrong range
18	Input2high	connected measured value in the wrong range
19	Input3high	connected measured value in the wrong range
20	Input4high	connected measured value in the wrong range
21	Input5high	connected measured value in the wrong range
22	Input6high	connected measured value in the wrong range
23	Input7high	connected measured value in the wrong range
24-31	-	not used

9.7.7 Analog inputs

The digitized input values can be found in the following variables:

Variable	Data type	Explanation
TempInputn	INT	Value for channel n (n=0...7) in 0.1°C, Ω or 2μV

9.7.8 ControlWord

The control word contains a bit for error acknowledgement.

Bit	Name	Explanation
0	ResetError	0 -> Errors remain active, 1 -> Error is reset (error cause removed)
1-15	-	not used

9.7.9 Cold-junction compensation

Cold-junction compensation is performed automatically when thermocouples are used. The temperature is measured directly at the plug near the connections.

9.7.10 Calibration

A calibration by the end user is not intended for this module, the necessary calibrations are carried out after module production.

The calibration can only be carried out once, because the calibration values are permanently stored.

The objects available in the start parameters for calibration (2010:n; 2011:n and 2012:n) are for internal use only.

9.7.11 Object Dictionary

Index	Name	Type	Default	Min Max	A c - cess
1000	Device Typ	UINT32	0x40191		RO
1001	Error Register	UINT8			RO
1008	Device Name	String	AI8_Pt/Ni/ Thermo		RO
1009	Hardware Version	String	1.00		RO
100A	Software Version	String	1.00		RO
1018	Identity Object	Array			
1018, 0	Number of Entries	UINT8	4		RO
1018, 1	Vendor Id	UINT32	0x0048554B		RO
1018, 2	Product Code	UINT32	185346		RO
1018, 3	Revision Number	UINT32	1		RO
1018, 4	Serial Number	UINT32			RO
2000	Sensor Type	Array			
2000, 0	Number of Entries	UINT8	8		RO
2000, 1	Sensor0	UINT8	Off	Off (0), Internal (1), PT100 (2), PT1000 (3), NI100 (4), NI1000 (5), Thermo_K (6), Thermo_J (7)	RW
2000, 2	Sensor1	UINT8	Off	Off, Internal, PT100, PT1000, NI100, NI1000, Thermo_K, Thermo_J	RW
2000, 3	Sensor2	UINT8	Off	Off, Internal, PT100, PT1000, NI100, NI1000, Thermo_K, Thermo_J	RW

2000, 4	Sensor3	UINT8	Off	Off, Internal, PT100, PT1000, NI100, NI1000, Thermo_K, Thermo_J	RW
2000, 5	Sensor4	UINT8	Off	Off, Internal, PT100, PT1000, NI100, NI1000, Thermo_K, Thermo_J	RW
2000, 6	Sensor5	UINT8	Off	Off, Internal, PT100, PT1000, NI100, NI1000, Thermo_K, Thermo_J	RW
2000, 7	Sensor6	UINT8	Off	Off, Internal, PT100, PT1000, NI100, NI1000, Thermo_K, Thermo_J	RW
2000, 8	Sensor7	UINT8	Off	Off, Internal, PT100, PT1000, NI100, NI1000, Thermo_K, Thermo_J	RW
2001	Input Format	Array			
2001, 0	Number of Entries	UINT8	8		RO

ANALOG KEB I/O MODULES

2001, 1	Input0Format	UINT8	0.1 °C	0.1°C (0), Ω / V (1) Raw (2)	RW
2001, 2	Input1Format	UINT8	0.1 °C	0.1°C, Ω / V Raw	RW
2001, 3	Input2Format	UINT8	0.1 °C	0.1°C, Ω / V Raw	RW
2001, 4	Input3Format	UINT8	0.1 °C	0.1°C, Ω / V Raw	RW
2001, 5	Input4Format	UINT8	0.1 °C	0.1°C, Ω / V Raw	RW
2001, 6	Input5Format	UINT8	0.1 °C	0.1°C, Ω / V Raw	RW
2001, 7	Input6Format	UINT8	0.1 °C	0.1°C, Ω / V Raw	RW
2001, 8	Input Format	UINT8	0.1 °C	0.1°C, Ω / V Raw	RW
2002	Data RateAndFilter	Array			
2002, 0	Number of Entries	UINT8	8		
2002, 1	Input0DataRateAnd Filter	UINT8	20 PLC	1000 PLC (0) 600 PLC (1) 330 PLC (2) 175 PLC (3) 90 PLC (4) 45 PLC (5) 20 PLC (6) 20 PLC+50&60Hz (7) 20 PLC + 50Hz (8) 20 PLC + 60 Hz (9)	RO

2002, 2	Input1DataRateAndFilter	UINT8	20 PLC	1000 PLC 600 PLC 330 PLC 175 PLC 90 PLC 45 PLC 20 PLC 20 PLC+50&60Hz 20 PLC + 50Hz 20 PLC + 60 Hz	RO
2002, 3	Input2DataRateAndFilter	UINT8	20 PLC	1000 PLC 600 PLC 330 PLC 175 PLC 90 PLC 45 PLC 20 PLC 20 PLC+50&60Hz 20 PLC + 50Hz 20 PLC + 60 Hz	RO
2002, 4	Input3DataRateAndFilter	UINT8	20 PLC	1000 PLC 600 PLC 330 PLC 175 PLC 90 PLC 45 PLC 20 PLC 20 PLC+50&60Hz 20 PLC + 50Hz 20 PLC + 60 Hz	RO
2002, 5	Input4DataRateAndFilter	UINT8	20PLC	1000PLC 600PLC 330PLC 175 PLC 90 PLC 45 PLC 20 PLC 20 PLC+50&60Hz 20 PLC + 50Hz 20 PLC + 60 Hz	RO



ANALOG KEB I/O MODULES

2002, 6	Input5DataRateAnd Filter	UINT8	20 PLC	1000PLC 600PLC 330PLC 175 PLC 90 PLC 45 PLC 20 PLC 20 PLC+50&60Hz 20 PLC + 50Hz 20 PLC + 60 Hz	RO
2002, 7	Input6DataRateAndFilter	UINT8	20 PLC	1000PLC 600PLC 330PLC 175 PLC 90 PLC 45 PLC 20 PLC 20 PLC+50&60Hz 20 PLC + 50Hz 20 PLC + 60 Hz	RO
2002, 8	Input7DataRateandFilter	UINT8	20 PLC	1000PLC 600PLC 330PLC 175 PLC 90 PLC 45 PLC 20 PLC 20 PLC+50&60Hz 20 PLC + 50Hz 20 PLC + 60 Hz	RO
2003	Average	Array			
2003, 0	Number of Entries	UINT8	8		RO
2003, 1	Input 0 Average	UINT8	1	1...255	RW
2003, 2	Input 1 Average	UINT8	1	1...255	RW
2003, 3	Input 2 Average	UINT8	1	1...255	RW
2003, 4	Input 3 Average	UINT8	1	1...255	RW
2003, 5	Input 4 Average	UINT8	1	1...255	RW
2003, 6	Input 5 Average	UINT8	1	1...255	RW
2003, 7	Input 6 Average	UINT8	1	1...255	RW
2003, 8	Input 7 Average	UINT8	1	1...255	RW
6401	Analog Input	Array			
6401, 0	Number of Entries	UINT8	8		RO
6401, 1	Analog Input 0	UINT16			RO P

6401, 2	Analog Input 1	UINT16			RO P
6401, 3	Analog Input 2	UINT16			RO P
6401, 4	Analog Input 3	UINT16			RO P
6401, 5	Analog Input 4	UINT16			RO P
6401, 6	Analog Input 5	UINT16			RO P
6401, 7	Analog Input 6	UINT16			RO P
6401, 8	Analog Input 7	UINT16			RO P
6500	StateWord	Array			
6500, 0	Number of Entries	UINT8	32		RO
6500, 1	ResetErrorAck	BOOL			RO P
6500, 2	-	BOOL			RO P
6500, 3	EtherCAT Error	BOOL			RO P
6500, 4	ConfigError	BOOL			RO P
6500, 5...8	-	BOOL			RO P
6500, 9	Input 0 low	BOOL			RO P
6500, 10	Input 1 low	BOOL			RO P
6500, 11	Input 2 low	BOOL			RO P
6500, 12	Input 3 low	BOOL			RO P
6500, 13	Input 4 low	BOOL			RO P
6500, 14	Input 5 low	BOOL			RO P
6500, 15	Input 6 low	BOOL			RO P
6500, 16	Input 7 low	BOOL			RO P
6500, 17	Input 0 high	BOOL			RO P
6500, 18	Input 1 high	BOOL			RO P
6500, 19	Input 2 high	BOOL			RO P
6500, 20	Input 3 high	BOOL			RO P
6500, 21	Input 4 high	BOOL			RO P
6500, 22	Input 5 high	BOOL			RO P
6500, 23	Input 6 high	BOOL			RO P
6500, 24	Input 7 high	BOOL			RO P
6500, 25...32	ResetErrorAck	BOOL			RO P
6500, 1	EtherCAT Error	BOOL			RO P
6500, 3	ConfigError	BOOL			RO P
6500, 4	Module Control	Array			
7001	Number of Entries	UINT8	1		RO
7001, 0	Reset Error	BOOL			RW P
7001, 1					

RO=Read only, RW= Read/Write, P=Process image

9.7.12 Technical data

Analog inputs	8		
Resolution	16 Bit		
Limit frequency input filter	0.33Hz (typically)		
Conversion time	50ms (adjustable)		
Thermocouple			
Sensor types	J,K, mV (internal)		
Cold-junction compensation	yes		
Measuring range type K	200°C...+1372°C		
Measuring range type J	-50°C...+760°C		
Measuring range mV	-40 ... +65 mV		
Measuring error	<±0.54% (of the upper range value)		
Temperature drift	<±50ppm (of the upper range value)		
Pt1000 / Ni1000 DIN43760			
Measuring range Pt	-75°C...+670°C		
Measuring range Ni	-60°C...+250°C		
Input resistance	700...3200		
Measuring current	0.1mA (typically)		
Measuring error	<±1.0°C (at 25°C ambient temperature)		
Baud rate	100 Mbit/s		
Controller	ASIC ET1200		
E-bus port	10-pin system plug in side wall		
Term. module	not required		
Connection I/O / power	Connector 36-pole		
Voltage supply	no		
E-bus load	170mA		
Part no.	00C6CC1-1900		
Approvals		 LISTED Prog. Cntrl. E479848	 EtherCAT® Conformance tested

10 Multi Fieldbus Interface



Downloading and reading the documentation is possible here: [MFI manual](#)

10.1 PROFINET-Slave - Technical Data

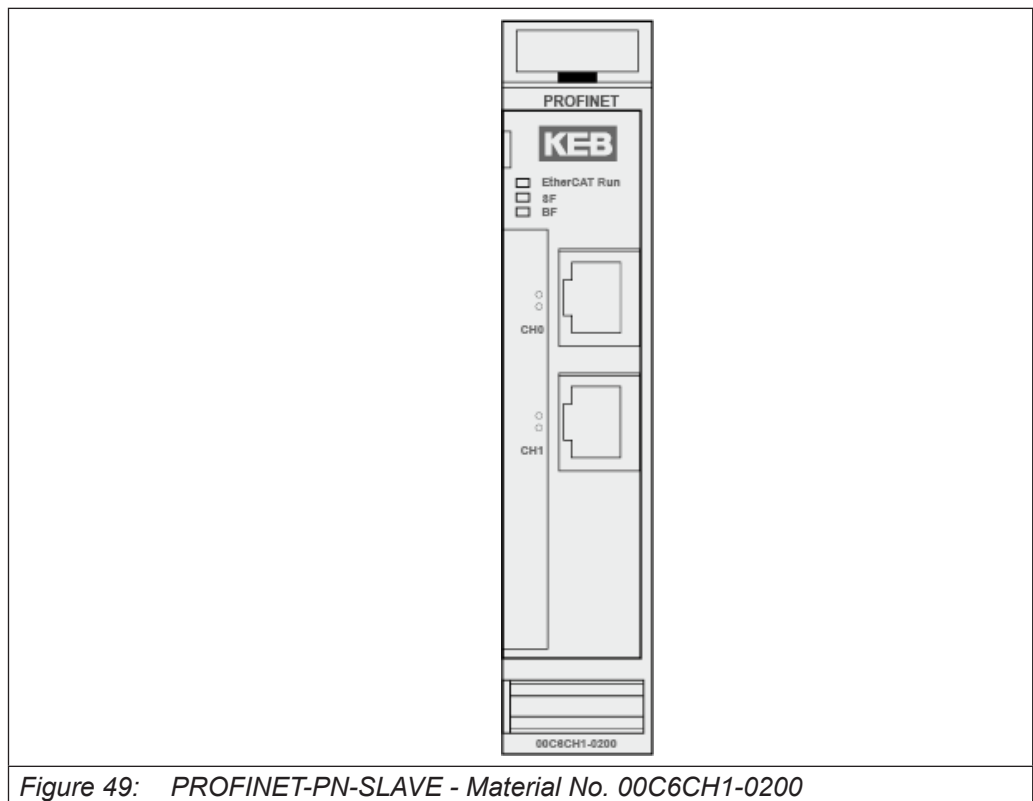





Figure 49: PROFINET-PN-SLAVE - Material No. 00C6CH1-0200

Fieldbus1 (system)	EtherCAT 100 Mbit/s		
EtherCAT file	KEB_C6_MFI.xml		
Fieldbus2	PROFINET-Slave		
Implementation type	NetX		
Interface	2x Ethernet-Port (RJ45)		
Baud rate	max. 100 Mbit/s		
Detection	automatically		
Addressing	via EtherCAT variables		
WxHxD	25x120x90mm		
Installation	35mm DIN mounting rail		
Controller	ASIC ET1200		
Connection	10-pin system plug in the side wall		
Voltage supply	from EtherCAT coupler via E-bus connector		
E-bus load	400mA for Out1 & Out2		
Potential separation	modules electrically insulated from one another and from the bus		
Storage temperature	-25°C...+70°C		
Operating temperature	0°C...+55°C		
Relative humidity	5% ... 95%, non-condensing		
Degree of protection	IP20		
Interference immunity	Zone B, mounted on earthed DIN rail in earthed control cabinet		
Interference immunity	Zone B		
Part no.	00C6CH1-0200		
Approvals			

10.2 EtherCAT-Slave - Technical Data

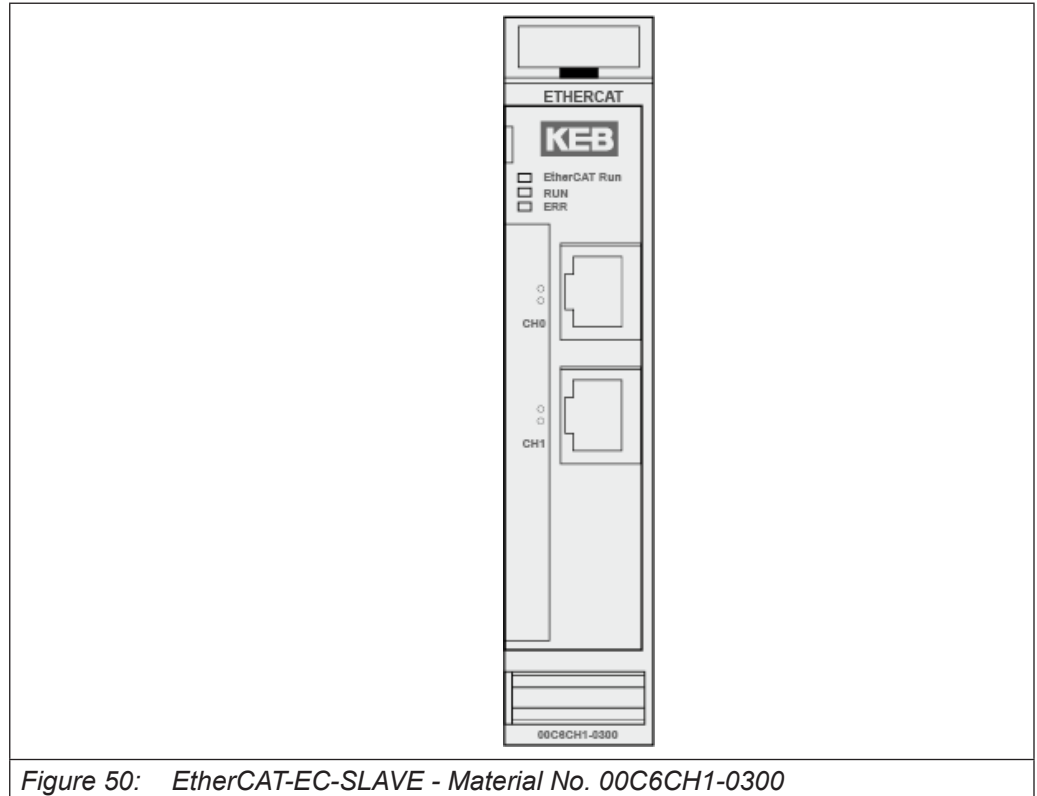





Figure 50: EtherCAT-EC-SLAVE - Material No. 00C6CH1-0300

Fieldbus1 (system)	EtherCAT 100 Mbit/s		
EtherCAT file	KEB_C6_MFI_EtherCAT.xml		
Fieldbus2	EtherCAT Slave		
Implementation type	NetX		
Interface	2x Ethernet-Port (RJ45)		
Baud rate	max. 100 Mbit/s		
Detection	automatically		
Addressing	Topological or via EtherCAT		
WxHxD	25x120x90mm		
Installation	35mm DIN mounting rail		
Controller	ASIC ET1200		
Connection	10-pin system plug in the side wall		
Voltage supply	from EtherCAT coupler via E-bus connector		
E-bus load	400mA for Out1 & Out2		
Potential separation	modules electrically insulated from one another and from the bus		
Storage temperature	-25°C...+70°C		
Operating temperature	0°C...+55°C		
Relative humidity	5% ... 95%, non-condensing		
Degree of protection	IP20		
Interference immunity	Zone B, mounted on earthed DIN rail in earthed control cabinet		
Part no.	00C6CH1-0300		
Approvals			

10.3 Ethernet-IP-Slave - Technical Data

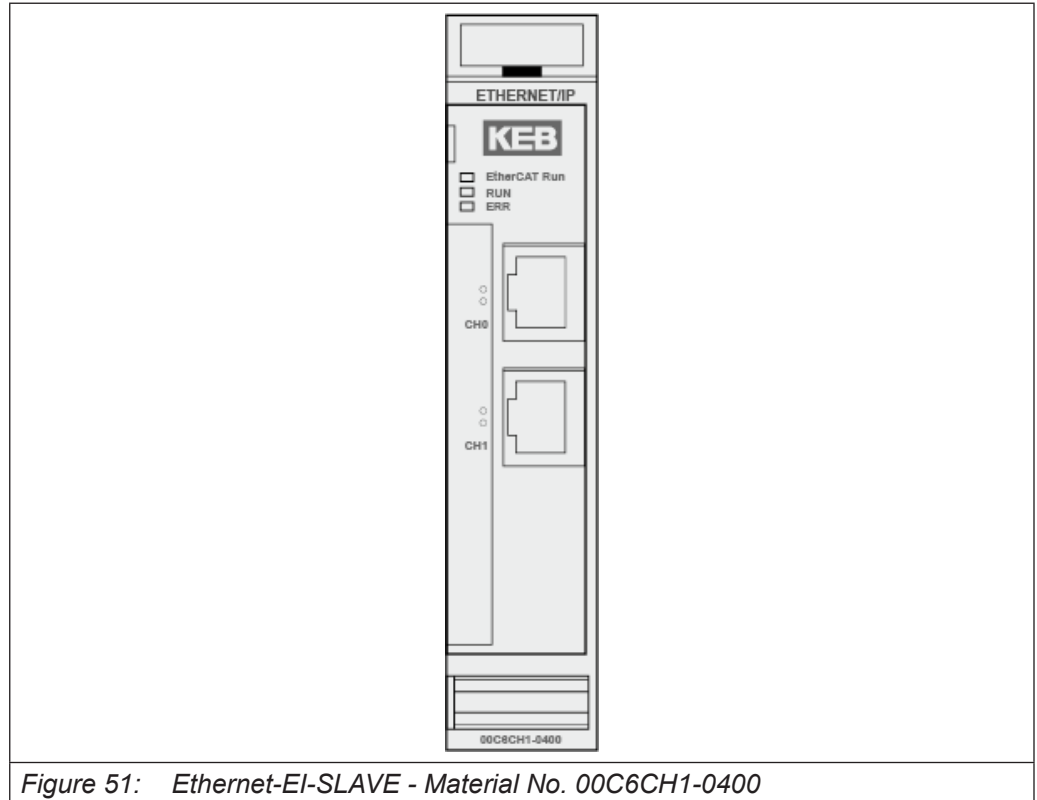





Figure 51: Ethernet-EI-SLAVE - Material No. 00C6CH1-0400

Fieldbus1 (system)	EtherCAT 100 Mbit/s		
EtherCAT file	KEB_C6_MFI_EthernetIP.xml		
Fieldbus2	Ethernet/IP-Slave		
Implementation type	NetX		
Interface	2x Ethernet-Port (RJ45)		
Baud rate	max. 100 Mbit/s		
Detection	automatically		
Addressing	via EtherCAT variables		
WxHxD	25x120x90mm		
Installation	35mm DIN mounting rail		
Controller	ASIC ET1200		
Connection	10-pin system plug in the side wall		
Voltage supply	from EtherCAT coupler via E-bus connector		
E-bus load	400mA for Out1 & Out2		
Potential separation	modules electrically insulated from one another and from the bus		
Storage temperature	-25°C...+70°C		
Operating temperature	0°C...+55°C		
Relative humidity	5% ... 95%, non-condensing		
Degree of protection	IP20		
Interference immunity	Zone B, mounted on earthed DIN rail in earthed control cabinet		
Part no.	00C6CH1-0400		
Approvals			

10.4 POWERLINK-Slave - Technical Data

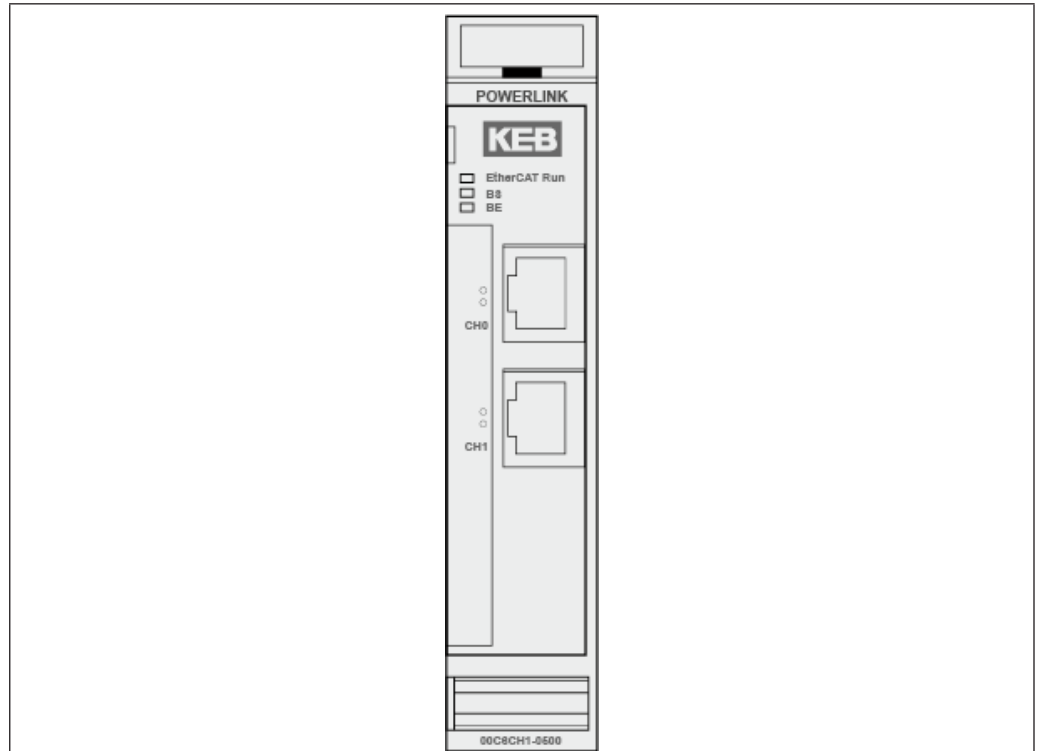





Figure 52: POWERLINK-PL-SLAVE - Material No. 00C6CH1-0500

Fieldbus1 (system)	EtherCAT 100 Mbit/s		
EtherCAT file	KEB_C6_MFI_Powerlink.xml		
Fieldbus2	Powerlink		
Implementation type	NetX		
Interface	2x Ethernet-Port (RJ45)		
Baud rate	max. 100 Mbit/s		
Detection	automatically		
Addressing	via EtherCAT variables		
WxHxD	25x120x90mm		
Installation	35mm DIN mounting rail		
Controller	ASIC ET1200		
Connection	10-pin system plug in the side wall		
Voltage supply	from EtherCAT coupler via E-bus connector		
E-bus load	400mA for Out1 & Out2		
Potential separation	modules electrically insulated from one another and from the bus		
Storage temperature	-25°C...+70°C		
Operating temperature	0°C...+55°C		
Relative humidity	5% ... 95%, non-condensing		
Degree of protection	IP20		
Interference immunity	Zone B, mounted on earthed DIN rail in earthed control cabinet		
Part no.	00C6CH1-0500		
Approvals			

11 Drive Control Stepper



Downloading and reading the documentation is possible here:
[Drive Control Stepper](#)

11.1 Technical data

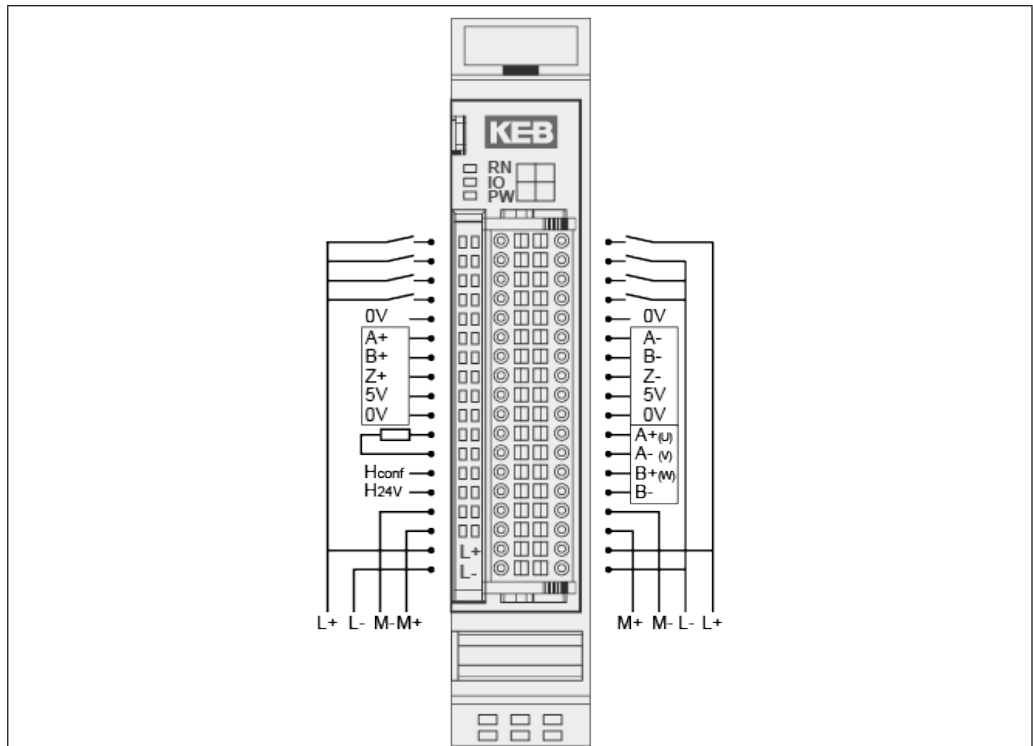

Figure 53: Drive Control Stepper - Material No. 00C6CJ1-0100

Fieldbus	EtherCAT 100 Mbit/s				
EtherCAT controller	ASIC ET1200				
Baud rate	100 Mbit/s				
E-bus port	10-pin system plug in side wall				
Electrical insulation	Modules electrically insulated from one another and from the bus.				
Diagnosis	LED: bus status, module status				
Connection IO/Power	36-pin spring-assisted combi plug with mechanical ejector-				
E-bus load	max. 100 mA				
Term. module	not required				
Supply voltage logic part (L+)	24 V DC -20% / +25%				
Interference immunity	Zone B to EN 61131-2, mounted on earthed DIN rail in earthed control cabinet.				
Service conditions					
Degree of protection	IP20				
Mounting position	vertical, stackable				
Storage temperature	-25°C ... + 70°C				
Operating temperature	0°C ... + 55°C				
Relative humidity	5% ... 95%, non-condensing				
Mechanical properties					
Installation	35mm DIN-rail (mounting rail)				
Dimensions	25mm x 120mm x 90mm (B x H x T)				
Housing mount	Aluminium				
Shield connection	directly at the module housing				
Module-specific details					
Product name	KEB C6 Remonte I/O Stepper/BLDC				
Article number	00C6CJ1-0100				
Motor connection	2-phase stepper motor or brushless DC motor				
Motor supply voltage (M+)	max. 72 VDC				
Motor voltage	12...24 VDC	>24...48 VDC		>48...72 VDC 1)	
Nominal motor current	5A ²⁾	4.2A ³⁾	4.5A ²⁾	3.9A ³⁾	Tbd. Tbd.
Peak current	stepper motor: 10A / brushless DC motor: 15A				
Incremental encoder	5V / 24V (A, /A, B, /B, Z, /Z) Count frequency RS422: 200kHz, 24V Single ended 25kHz Note: Connect unused encoder signals to + 5V DC!				
Hall sensor	5V / 24V (H1, H2, H3) or 3 extra low side switching digital inputs Count frequency 25kHz				
Digital inputs	5x 1ms (configurable, e.g. reference switch, limit switch, enable)				
Digital outputs	1x 0.5A (brake output or standard output)				
1) Not cULus approved 2) without load at the digital output 3) with max. 0.5A load at the digital output					

12 Safety PLC



Downloading and reading the documentation is possible here:
[Safety PLC](#)

12.1 Technical data

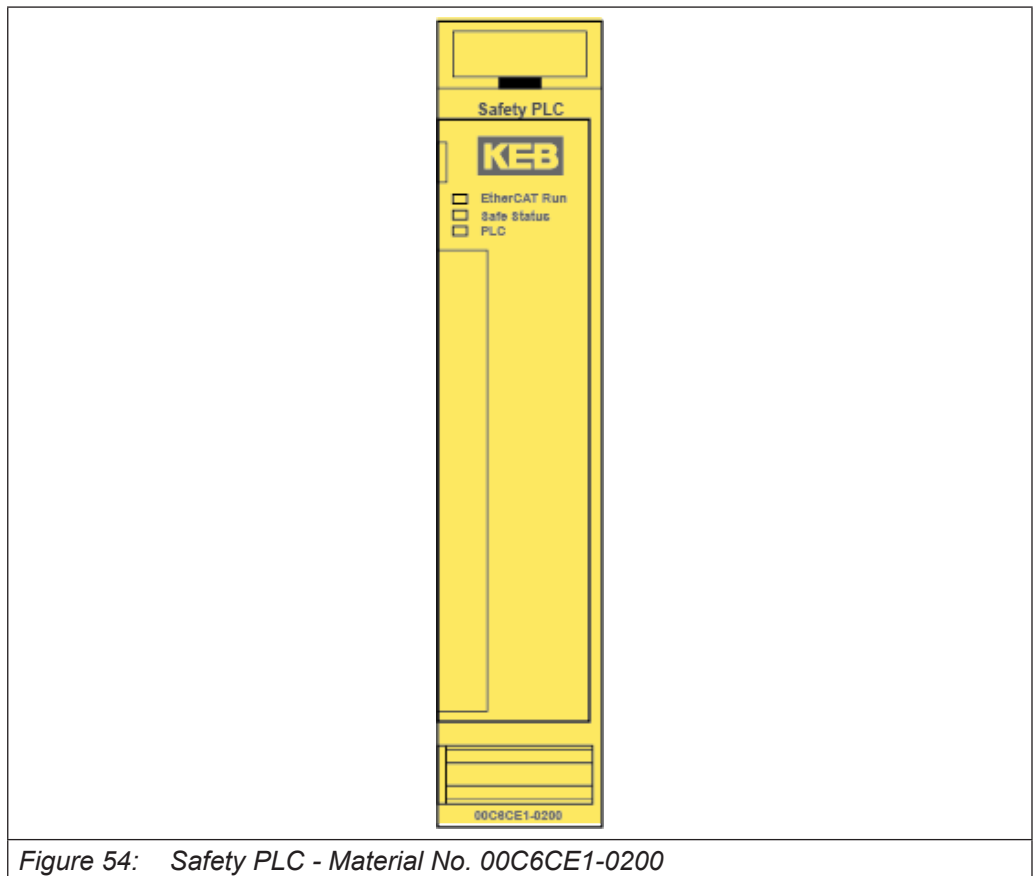



Figure 54: Safety PLC - Material No. 00C6CE1-0200

Product name	Safety PLC
Fieldbus	EtherCAT 100Mbit/s
E-bus port	10-pin system plug in side wall
Electrical insulation	All modules electrically insulated from one another and from the bus
Diagnosis	LEDs
E-bus load	maximum 240 mA (system supply)
Term. module	Cover for module bus required on last module
System power supply	
Supply voltage	5 V DC via E-bus connection comes from the head module (bus coupler or PLC in accordance with EN 61131-2, supply with 24 V DC, min. -15% / +20% SELV/PELV)
Overvoltage category	Category II according to EN 61131-2
Reverse polarity safeguard	Yes
Interference immunity	Installation in zone B according to 61000-6-2, in accordance with EN 61131-2, mounted on earthed DIN rail in earthed control cabinet. Lay the earthing according to the operating conditions.
Storage and transport conditions	
Surrounding temperature	-25°C ... + 70°C
Relative humidity	5% ... 95%, non-condensing
Atmospheric pressure	70 kPa to 108 kPa
Vibration	5 to 8.4 Hz: +/- 3.5 mm amplitude, 8.4 to 150 Hz: 10 m/ s ² (1g), to IEC 60068-2-6, Fc test
Shock	150 m/s ² (15g), 11 ms semi-sinusoidal wave to IEC 60068-2-27
Service conditions	
Mounting position	horizontal, stackable
Degree of contamination	II to IEC 60664-3
Admissible operating environment	Operation restricted to environment complying with IP54 or better to IEC 60529 (e.g. suitable control cabinet)
Operating temperature	0°C ... + 55°C
Relative humidity	5% ... 95%, non-condensing
Atmospheric pressure	80 kPa to 108 kPa
Vibration	5 to 8.4 Hz: +/- 3.5 mm amplitude, 8.4 to 150 Hz: 10 m/ s ² (1g), to IEC 60068-2-6, Fc test
Shock	150 m/s ² (15g), 11 ms semi-sinusoidal wave to IEC 60068-2-27
Mechanical properties	
Installation	35 mm DIN rail (mounting rail)
Dimensions	25 mm x 120 mm x 90 mm (W x H x D)
Degree of protection	IP20
Housing mount	Aluminium
Shield connection	directly at the module housing

continued on the next page

13 EtherCAT Safe-IN4 / Safe-Out2

	Downloading and reading the documentation is possible here: Safe-IN4 / Safe-Out2
---	---

13.1 Technical data

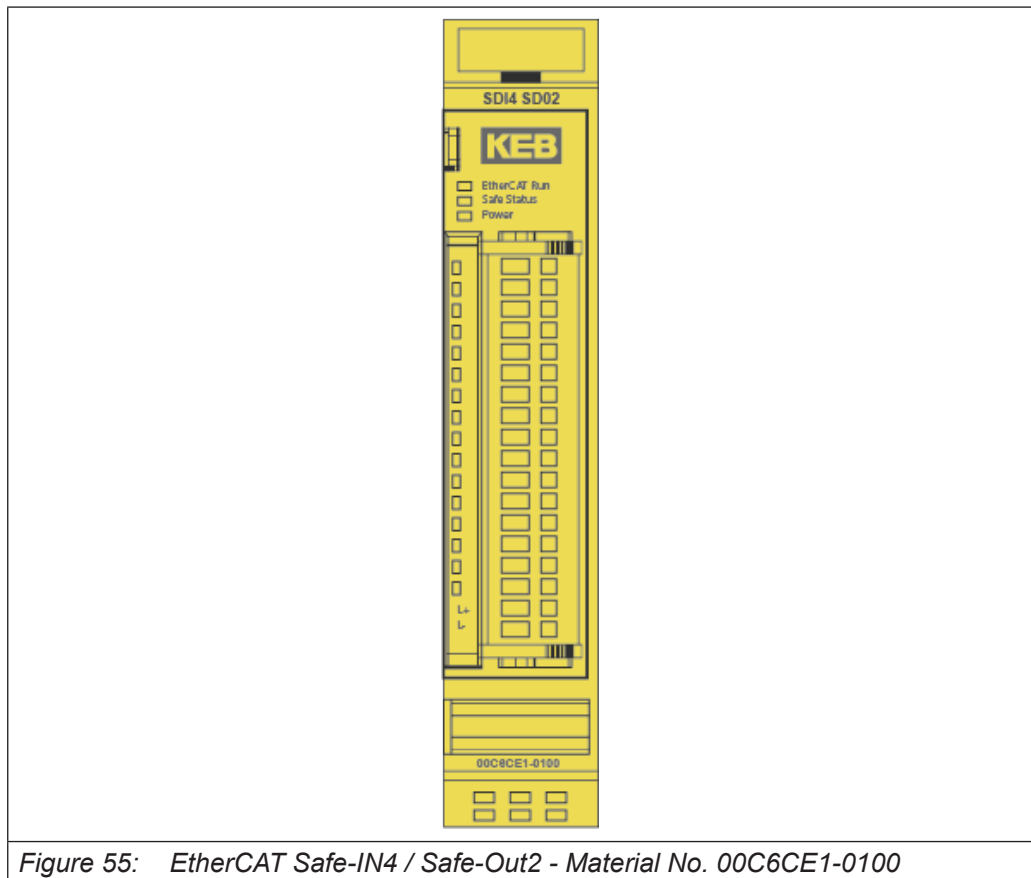

Product name	KEB-I/O EtherCAT Safe-In4 / Safe-Out2
Fieldbus	EtherCAT 100Mbit/s
Controller	ASIC ET1200
Baud rate	100 Mbit/s
E-bus port	10-pin system plug in side wall
Electrical insulation	All modules electrically insulated from one another and from the bus
Diagnosis	LED: bus state, module state, broken wire/overcurrent
I/O power connection	male 18-pole connector (not included in module package) Part No. 00C6CD1-0200) 18-pole spring-assisted combi plug with mechanical ejector
E-bus load	max. 300 mA (system power supply)
Term. module	not required
Power supply (I/O system power supply)	
Supply voltage	24 V DC -15% / +20% (SELV/PELV)
Overvoltage category	Category II according to EN 61131-2
Module power consumption	approx. 7 mA + load current
Reverse polarity safeguard	Yes
Nominal insulation voltage	500 V _{eff} measured between I/O supply and E-bus
Interference immunity	Zone B to EN 61131-2 Mounted on earthed mounting rail in earthed control cabinet
Storage and transport conditions	
Temperature	-25°C ... + 70°C
Relative humidity	5% ... 95%, non-condensing
Atmospheric pressure	70 kPa to 108 kPa / 0 to 3000 m above msl
Vibration	5 to 8.4 Hz: +/- 3.5 mm amplitude, 8.4 to 150 Hz: 10 m/ s ² (1g), to IEC 60068-2-6, Fc test
Shock	150 m/s ² (15g), 11 ms semi-sinusoidal wave to IEC 60068-2-27
Service conditions	
Mounting position	horizontal, stackable
Degree of contamination	II to IEC 60664-3
Admissible operating environment	Operation restricted to environment complying with IP54 or better to IEC 60529 (e.g. suitable control cabinet)
Operating temperature	0°C ... + 55°C
Relative humidity	5% ... 95%, non-condensing
Atmospheric pressure	80 kPa to 108 kPa / 0 to 2000 m msl
Vibration	5 to 8.4 Hz: +/- 3.5 mm amplitude, 8.4 to 150 Hz: 10 m/ s ² (1g), to IEC 60068-2-6, Fc test
Shock	150 m/s ² (15g), 11 ms semi-sinusoidal wave to IEC 60068-2-27
Mechanical properties	
Installation	35 mm DIN rail (mounting rail)
Dimensions	25 mm x 120 mm x 90 mm (W x H x D)
Degree of protection	IP20
Housing mount	Aluminium
Shield connection	directly at the module housing

14 Accessories

14.1 Shielding clamps

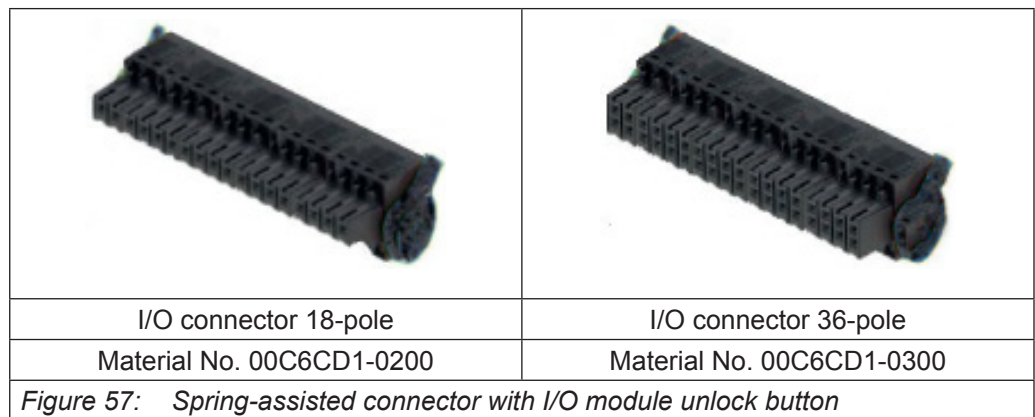
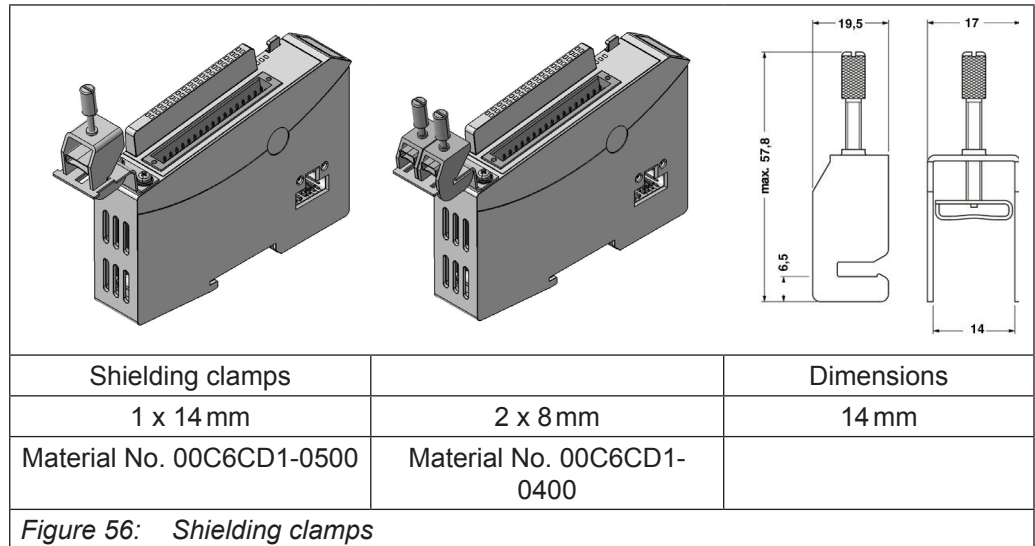

Only the 2-pole connectors of the I/O bus coupler module are part of the module and are supplied automatically.

The 18-pole and 36-pole I/O/ power connectors and D-SUB connectors are not part of the modules and must be ordered separately.

14.1.1 Terminals

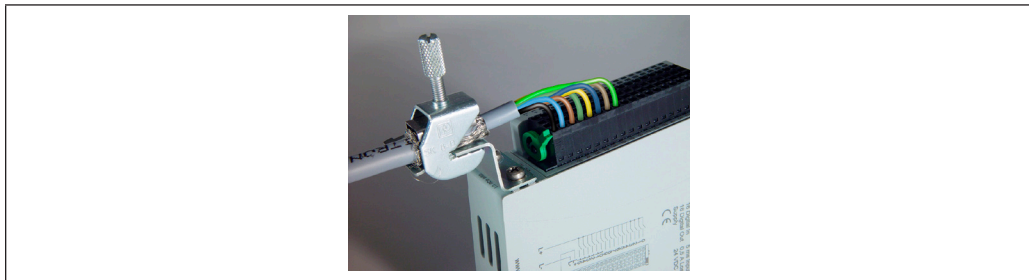

Figure 58: Terminals

The shield connection clamp consists of the shield clamp, the terminal holder, 2 screws M3x5 and 2 washers.

The terminal holder must be fastened with 2 screws and washers at the housing mount of the C6 Remote I/O module.

Use the tapped holes on the front side. They are provided for it.

14.1.2 I/O modules

The I/O supply connects to the I/O module, normally together with the I/Os, using plug-type terminal blocks with different number of poles.

Power to the I/O module logic circuits is supplied by the bus coupler.

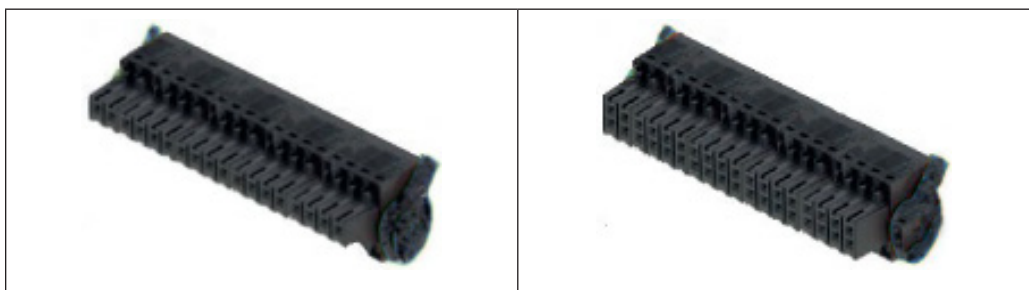

I/O connector 18-pole	I/O connector 36-pole
Material No. 00C6CD1-0200	Material No. 00C6CD1-0300
Figure 59: Spring-assisted connector with I/O module unlock button	

15 Configuration with COMBIVIS studio 6

For the EtherCAT configuration you need the file KebabModules.xml which is already included and pre-installed in COMBIVIS studio 6. If necessary this file must be imported into the used (third-party) EtherCAT-Master configurator.

Example:

C6 PLC as EtherCAT master, configuration with EtherCAT configurator from COMBIVIS studio6.

Online scan for devices

For the basic bus configuration add an EtherCAT master below the used target control, select the appropriate hardware interface and log into the control (without configure further EtherCAT slaves). Then you can search the connected slaves by right click on the EtherCAT master → scan devices online. Then the IDE makes a mirroring of the online identified devices with those in device opository and the result is tabularly listed. Then the identified slaves can be transferred to the PLC project by clicking on "Copy all devices to project".

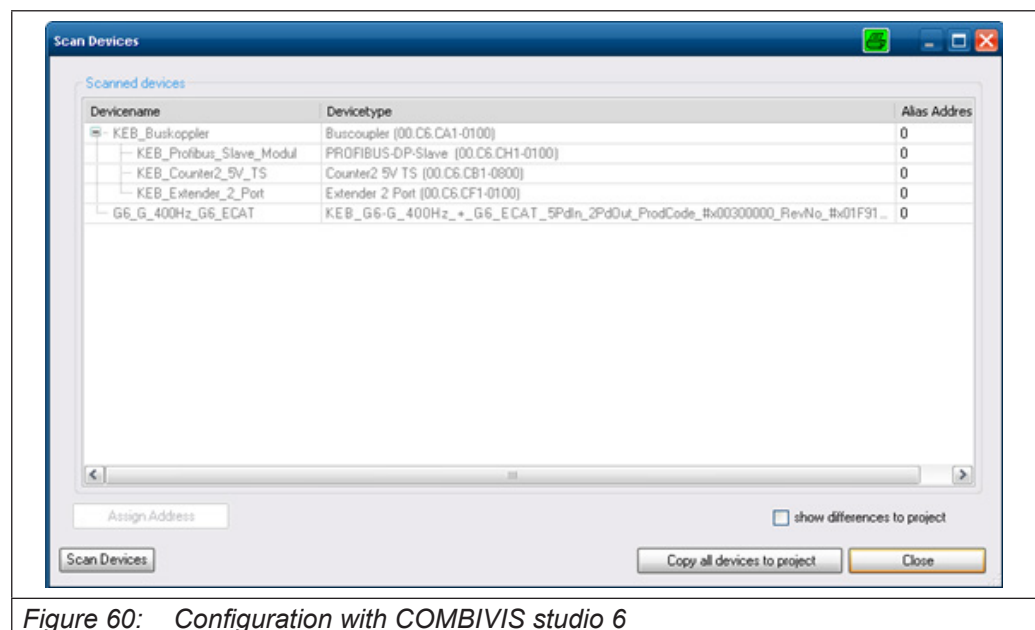

Figure 60: Configuration with COMBIVIS studio 6

15.1 Offline configuration

Instead of the scan the unit configuration can also be done manually. For this right click on the added EtherCAT master and select 'Add device'. A window opens with an overview of the currently available EtherCAT slave device descriptions on the development PC. Select the appropriate slave and confirm with 'OK'.

16 Change history

Version	Date	Description
00	2018-06	Pre-series
01	2019-04	Series - Update part numbers and safety information
02	2020-07	Revision analogue IO-modules

17 Configuration with EtherCAT Technology Group Configurator

The following procedure must be applied when using the ETG configurator.

There are two possibilities to document the characteristics of an EtherCAT slave.

- The basic properties are stored in an EEPROM of the slave, others are described in an XML device file.
- The characteristics are completely stored in an EEPROM of the slave. This method is not supported by any manufacturer.

EtherCAT configurators obtain convenient options by XML device files.

EtherCAT allows both, a configuration offline and the scanning of station data via an Ethernet line (online configuration).

The examples below are based around the standard ETG configuration tool (EtherCAT configuration tool supplied by Beckhoff Automation GmbH) which accesses the XML device files for both offline and online configuration.

For C6 Remote I/O it is the file „KebloModules.xml“.

Copy the file „KebloModules.xml“ into the directory C:\Programs\EtherCAT Configurator\EtherCAT or into the directory prescribed for the used configurator.

17.1 Offline configuration

- Start the EtherCAT configuration tool.
- Choose File, New to create a new I/O configuration.
- Select I/O Devices and operate „Append Devices“. This will add „Device 1 (EtherCAT)“ to your configuration, i.e. a new EtherCAT line.

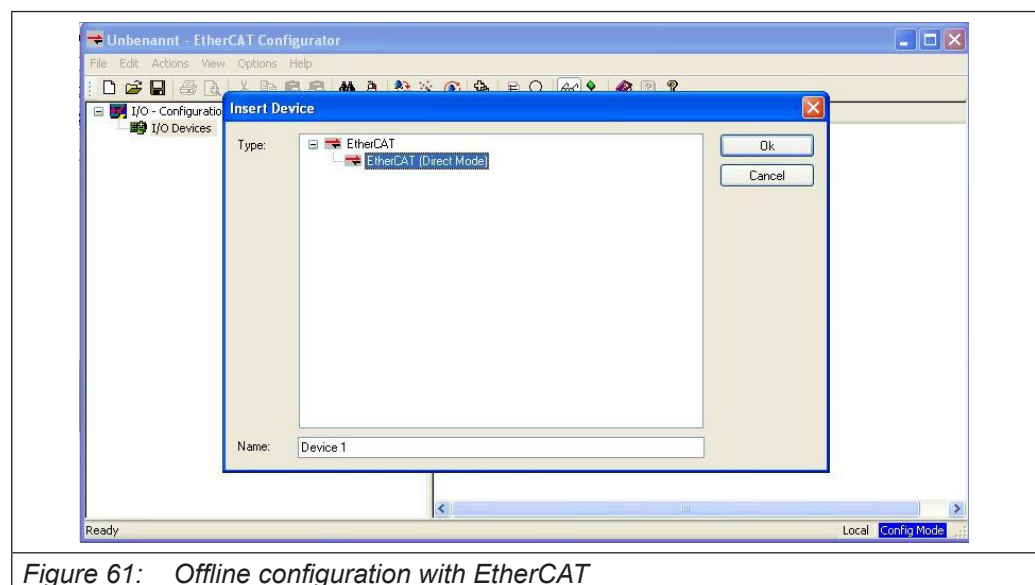

Figure 61: Offline configuration with EtherCAT

- Select „Device 1 (EtherCAT)“ and operate „Append Box“.
- Expand the branch labelled "KEB" and its sub-branch and select „Bus coupler“ (00C6CA1-0100).

- The software suggests to call it „Term1“. Change the name and add comments as appropriate.
- Select „Term 1 (C6 Remote I/O bus coupler)“ and operate „Append Box“.
- Expand the branch labelled "KEB Automation KG" and the sub-branch "Digital IO modules) and select e.g. "DI16/DO16 (00C6CB1-0600)".
- Keep repeating this step until your configuration is complete.

This completes the configuration required by the EtherCAT master which can be saved to an *.esm type of file. Then this file can be read also by other EtherCAT master.

18 Annex

18.1 Ordering data

Material No.	Name	IO/Power Connector
00C6CA1-0100	EtherCAT bus coupler (includes connector)	–
00C6CA1-0200	EtherCAT bus coupler + 16 digital input / 16 Digital Output (500 mA)	00C6CD1-0300
00C6CB1-0100	EtherCAT 16 digital input 24VDC, (1ms)	00C6CD1-0200
00C6CB1-0200	EtherCAT 32 digital input 24VDC, (1ms)	00C6CD1-0300
00C6CB1-0500	EtherCAT 16 digital output (500 mA)	00C6CD1-0200
00C6CB1-0600	EtherCAT 16 digital input / 16 digital output (500 mA)	00C6CD1-0300
00C6CB1-0800	EtherCAT counter2 (8DI / 2DO / fast input)	00C6CD1-0300
00C6CB1-0900	EtherCAT 16 digital input/ 8 digital output (1000 mA)	00C6CD1-0300
00C6CB1-1100	EtherCAT 8 digital output (1000 mA)	00C6CD1-0200
00C6CB1-1300	EtherCAT counter/posi 2 (8DI / 2DO / 2AO / fast input)	00C6CD1-0300
00C6CB1-1600	EtherCAT mix02 (4DI / 24DO / 4AI / RS485)	00C6CD1-0300
00C6CB1-1700	EtherCAT 8 digital output (relay 230VAC NO / 2000 mA)	00C6CD1-0200
00C6CB1-1800	EtherCAT 16 digital input / 16 digital output (500 mA)-LS	00C6CD1-0300
00C6CB1-2000	EtherCAT 8 digital output (relay 24VDC NO / 2000 mA)	00C6CD1-0200
00C6CB1-2100	EtherCAT 8 digital output (2000 mA)	00C6CD1-0200
00C6CC1-1300	EtherCAT 4 analog input (0-20 mA / 4-20 mA), 12bit (CoE)	00C6CD1-0200
00C6CC1-1400	EtherCAT 8 analog input (0-20 mA / 4-20 mA), 12bit (CoE)	00C6CD1-0300
00C6CC1-1500	EtherCAT 4/8 analog input (0-10V / +/- 10V), 13bit (CoE)	00C6CD1-0200
00C6CC1-1600	EtherCAT 8/16 analog input (0-10V / +/- 10V), 13bit (CoE)	00C6CD1-0300
00C6CC1-1700	EtherCAT 4 analog output (0-20 mA / 0-10V), 16bit (CoE)	00C6CD1-0200
00C6CC1-1800	EtherCAT 4 analog input (PT/NI/TC), 16bit (CoE)	00C6CD1-0200
00C6CC1-1900	EtherCAT 8 analog input (PT/NI/TC), 16bit (CoE)	00C6CD1-0300
00C6CE1-0100	EtherCAT safety SDI4 / SDO2	00C6CD1-0200
00C6CE1-0200	EtherCAT safety PLC	–
00C6CF1-0100	Extender 2 x RJ45 for EtherCAT branch	–
00C6CF1-0200	Potential distribution	00C6CD1-0300
00C6CH1-0200	EtherCAT MFI Profinet slave	–
00C6CH1-0300	EtherCAT MFI EtherCAT slave	–
00C6CH1-0400	EtherCAT MFI Ethernet/IP	–

00C6CH1-0500	EtherCAT MFI Powerlink slave	–
00C6CJ1-0100	EtherCAT drive module (Stepper / Brushless DC)	00C6CD1-0300

19 Certification

19.1 Mark of conformity

EU KONFORMITÄTSERKLÄRUNG



Dokument-Nr. / Monat.Jahr: ce_ca_remv-C6C-IO-f_de / 01.2019

Hersteller:	KEB Automation KG Südstraße 38 32683 BARNTRUP	
Produktbezeichnung:	Steuerung - Typenreihe Größe Spannungsklasse	yy C6C xx – xxxx yy = 00 x = beliebige Ziffer oder Buchstabe 24 Vdc

Das bezeichnete Produkt stimmt mit den Vorschriften folgender Europäischer Richtlinien überein:

Nummer:	EMV : 2014 / 30 / EU
Text:	Richtlinie des Rates zur Angleichung der Rechtsvorschriften der Mitgliedsstaaten über die elektromagnetische Verträglichkeit.
Nummer:	Gefährliche Substanzen: 2011 / 65 / EU (inkl. 2015 / 863 / EU)
Text:	Richtlinie des Rates zur Beschränkung der Verwendung bestimmter gefährlicher Stoffe in Elektro- und Elektronikgeräten.

Weitere Angaben zur Einhaltung dieser Richtlinien enthält der Anhang.

Anbringung der CE-Kennzeichnung: ja

Aussteller: KEB Automation KG
Südstraße 38
32683 BARNTRUP

Ort, Datum Barntrup, 28.12.2018

Rechtsverbindliche Unterschrift:

i. A. W. Hovestadt / Normenbeauftragter

W. Wiele / Technischer Leiter

Die Anhänge sind Bestandteil dieser Erklärung.
Diese Erklärung bescheinigt die Übereinstimmung mit den genannten Richtlinien, beinhaltet jedoch keine Zusicherung von Eigenschaften.

Die Sicherheitshinweise der mitgelieferten Produktdokumentation sind zu beachten.



ANHANG 1

Dokument-Nr. / Monat.Jahr: ce_ca_remv-C6C-IO-f_de / 01.2019

Produktbezeichnung: Steuerung - Typenreihe yy**C6C**xx – xxxx
 Größe yy = 00
 x = beliebige Ziffer oder Buchstabe
 Spannungsclassen 24 Vdc

Die Übereinstimmung des bezeichneten Produktes mit den Vorschriften der der Richtlinie 2014/30/EU wird nachgewiesen durch die vollständige Einhaltung der folgend angegebenen Normen. Grundlage für die Bewertung ist eine typische Konfiguration mit Zubehör und Antriebssystemen. Für die Einhaltung der Grenzwerte ist die Beachtung der EMV - Installationshinweise notwendig. Diese liegen jedem ausgelieferten Produkt als Teil der Dokumentation bei.

Berücksichtigte harmonisierte Europäische Normen:

EN - Norm	Text	Referenz	Ausgabe
EN 61000 – 6 – 4 Ausgabe 2007 + A1 aus 2011	Fachgrundnorm Funkentstörung Teil 2: Industriebereich	VDE 0839 – 6 - 4	09/2011
EN 61000 – 6 – 2 Ausgabe 2005 +Ber. 2011	Fachgrundnorm Störfestigkeit Teil 2: Industriebereich	VDE 0839 – 6 - 2	03/2006

Die Übereinstimmung des bezeichneten Produktes mit den Vorschriften der Richtlinie 2011/65/EG und der Änderung über 2015/863/EU wird nachgewiesen durch die Qualifikation von Bauteilen und Fertigungsverfahren im Rahmen der durch die ISO 9001 vorgegebene Qualitätssicherung. Die entsprechenden Informationen und Beschreibungen sind dokumentiert und abgelegt.

Das bezeichnete Produkt wurde unter einem umfassenden Qualitätsmanagementsystem entwickelt, hergestellt und geprüft.

Die Konformität des Qualitätsmanagementsystems nach DIN ISO 9001 wurde bescheinigt durch:

Notifizierte Stelle: TÜV - CERT
 Anschrift: Zertifizierungstelle des RWTÜV
 Steubenstrasse 53
 D - 45138 Essen

Nummer der Bescheinigung 041 004 500
 Ausstelldatum: 20.10.94
 Gültig durch Nachprüfung bis: 12.2021

19.2 UL approval



Acceptance according to UL for KEB products is marked by the adjacent logo and the E-file number on the nameplate. The instructions given in this manual must be observed.

Programmable Controllers

See General Information for Programmable Controllers

KEB AUTOMATION KG
 Suedstrasse 38
 32683 Barntrop, GERMANY

E479848

Investigated to ANSI/UL 508

Open type, Programmable controllers Model(s) 00C6CB1-0100, 00C6CB1-0200, 00C6CB1-0300, 00C6CB1-0400, 00C6CB1-0500, 00C6CB1-0600, 00C6CB1-0700, 00C6CB1-0800, 00C6CB1-0900, 00C6CB1-1000, 00C6CB1-1100, 00C6CB1-1200, 00C6CB1-1300, 00C6CB1-1400, 00C6CB1-1600, 00C6CB1-1700, 00C6CB1-1800, 00C6CB1-1900, 00C6CB1-2000, 00C6CB1-2100, 00C6CC1-0100, 00C6CC1-0200, 00C6CC1-0300, 00C6CC1-0400, 00C6CC1-0500, 00C6CC1-0700, 00C6CC1-0800, 00C6CC1-0900, 00C6CC1-1000, 00C6CC1-1100, 00C6CC1-1200, 00C6CC1-1300, 00C6CC1-1400, 00C6CC1-1500, 00C6CC1-1600, 00C6CC1-1700, 00C6CC1-1800, 00C6CC1-1900, 00C6CE1-0100, 00C6CE1-0200, 00C6CF1-0200, 00C6CH1-0100, 00C6CJ1-0100, 00C6HA1-xxxx, 00C6HB1-xxxx

Programmable Controllers Model(s) 00C6CA1-0100 where xy may be 00,02,03,04,06,07,08,09 or 10.
 00C6CF1-0100 where xy may be 00,02,03,04,06,07,08,09 or 10.

Programmable controllers Model(s) aaC6HA1-xxxx Where "a" may be any character for different sizes of panel display.
 aaC6HB1-xxxx Where "a" may be any character for different sizes of panel display.

Investigated to UL 61010-1 and UL 61010-2-201

Programmable Automation Controller, PAC Model(s) C6 Smart, xxC6Gxx-xxxx

Investigated to UL 61010-1, 3rd Edition and UL 61010-2-201, 1st Edition

Front-Panel Mounting or Open type Industrial PC Model(s) 00C6HM1-xxxx Where "xxxx" is a 4 digit / letter combination for different software configurations.

00C6HN1-xxxx Where "xxxx" is a 4 digit / letter combination for different software configurations.

aaC6HM1-xxxx Where "a" may be any character for different sizes of panel display. Where "xxxx" is a 4 digit / letter combination for different software configurations.

aaC6HN1-xxxx Where "a" may be any character for different sizes of panel display. Where "xxxx" is a 4 digit / letter combination for different software configurations.

industrial PC Model(s) 00C6HL1-xxxx Where "xxxx" is a 4 digit / letter combination for different software configurations.

Industrial PC Model(s) 00C6HP1-xxxx Where "xxxx" is a 4 digit / letter combination for different software configurations.

00C6HQ1-xxxx Where "xxxx" is a 4 digit / letter combination for different software configurations.

19.3 RoHS Declaration of Conformity

 The logo is a diamond shape with the text "RoHS" at the top and "2011/65/EU" at the bottom.	<p>In accordance with: EN 50581: Technical documentation for the assessment of electrical and electronic equipment with regard to the restriction of dangerous substances RoHS Directive 2011/65/EU</p>
---	---

Austria | KEB Automation GmbH

Ritzstraße 8 4614 Marchtrenk Austria
 Tel: +43 7243 53586-0 Fax: +43 7243 53586-21
 E-Mail: info@keb.at Internet: www.keb.at

Belgium | KEB Automation KG

Herenveld 2 9500 Geraardsbergen Belgium
 Tel: +32 544 37860 Fax: +32 544 37898
 E-Mail: vb.belgien@keb.de Internet: www.keb.de

Brazil | KEB South America - Regional Manager

Rua Dr. Omar Pacheco Souza Riberio, 70
 CEP 13569-430 Portal do Sol, São Carlos Brazil
 Tel: +55 16 31161294 E-Mail: roberto.arias@keb.de

France | Société Française KEB SASU

Z.I. de la Croix St. Nicolas 14, rue Gustave Eiffel
 94510 La Queue en Brie France
 Tel: +33 149620101 Fax: +33 145767495
 E-Mail: info@keb.fr Internet: www.keb.fr

Germany | **Headquarters**

KEB Automation KG
 Südstraße 38 32683 Barntrup Germany
 Telefon +49 5263 401-0 Telefax +49 5263 401-116
 Internet: www.keb.de E-Mail: info@keb.de

Germany | **Geared Motors**

KEB Antriebstechnik GmbH
 Wildbacher Straße 5 08289 Schneeberg Germany
 Telefon +49 3772 67-0 Telefax +49 3772 67-281
 Internet: www.keb-drive.de E-Mail: info@keb-drive.de

Italia | KEB Italia S.r.l. Unipersonale

Via Newton, 2 20019 Settimo Milanese (Milano) Italia
 Tel: +39 02 3353531 Fax: +39 02 33500790
 E-Mail: info@keb.it Internet: www.keb.it

Japan | KEB Japan Ltd.

15 - 16, 2 - Chome, Takanawa Minato-ku
 Tokyo 108 - 0074 Japan
 Tel: +81 33 445-8515 Fax: +81 33 445-8215
 E-Mail: info@keb.jp Internet: www.keb.jp

P.R. China | KEB Power Transmission Technology (Shanghai) Co. Ltd.

No. 435 QianPu Road Chedun Town Songjiang District
 201611 Shanghai P.R. China
 Tel: +86 21 37746688 Fax: +86 21 37746600
 E-Mail: info@keb.cn Internet: www.keb.cn

Republic of Korea | KEB Automation KG

Room 1709, 415 Missy 2000 725 Su Seo Dong
 Gangnam Gu 135- 757 Seoul Republic of Korea
 Tel: +82 2 6253 6771 Fax: +82 2 6253 6770 E-Mail: vb.korea@keb.de

Russian Federation | KEB RUS Ltd.

Lesnaya str, house 30 Dzerzhinsky MO
 140091 Moscow region Russian Federation
 Tel: +7 495 6320217 Fax: +7 495 6320217
 E-Mail: info@keb.ru Internet: www.keb.ru

Spain | KEB Automation KG

c / Mitjer, Nave 8 - Pol. Ind. LA MASIA
 08798 Sant Cugat Sessgarrigues (Barcelona) Spain
 Tel: +34 93 8970268 Fax: +34 93 8992035 E-Mail: vb.espana@keb.de

United Kingdom | KEB (UK) Ltd.

5 Morris Close Park Farm Industrial Estate
 Wellingborough, Northants, NN8 6 XF United Kingdom
 Tel: +44 1933 402220 Fax: +44 1933 400724
 E-Mail: info@keb.co.uk Internet: www.keb.co.uk

United States | KEB America, Inc

5100 Valley Industrial Blvd. South
 Shakopee, MN 55379 United States
 Tel: +1 952 2241400 Fax: +1 952 2241499
 E-Mail: info@kebameric.com Internet: www.kebameric.com



MORE KEB PARTNERS WORLDWIDE:

www.keb.de/company/representatives-agencies



Automation with Drive

www.keb.de

KEB Automation KG Suedstrasse 38 32683 Barntrup Germany Tel. +49 5263 401-0 E-Mail: info@keb.de