



DRIVE BASED SAFETY

The image shows a collection of KEB servo drives and a motor assembly. On the left is a tall, black, vertical servo motor with a silver shaft. In the center are two smaller, square servo drives, one in front of the other. On the right is a large, blue, industrial-grade servo drive cabinet with multiple ports and connectors on its front panel. The background features a light gray circuit board pattern.

COMBIVERT S6

SERVO DRIVES

EN



CONTENT	PAGE
System overview	3
Benefits at a glance	4
COMBIVERT S6 variants	6
Functional Safety	8
Electrical properties	10
Mechanical data, operating types, standards	11
Servo Motors DL3	12
Planetary gear	13
Servo Gear Motors	14
Servo Motors TA	15
DL3 cables	16
TA cables	17
Accessories	18
My Drive	19
COMBIVIS 6	20
KEB Service	22
KEB worldwide	23

SYSTEM OVERVIEW

Automation with Drive

stands for optimally selected combinations of control and automation solution. With the drive level at the end it is the key to successful machine concepts.

Let the following pages inspire you with regards to the diversity and performance of the COMBIVERT S6 servo system, and help you to find a solution that reliably meets your requirements.

IIoT



CONTROL HARDWARE

Visualisation



HMI

Engineering



Control Software

Remote Control

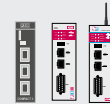

Router

CONTROL HARDWARE

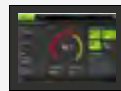

Web HMI



Embedded Control

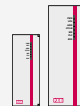

IPC



I/O



Safety PLC

DRIVES



Inverter



Servo Drive



Drive Controller



Pitch Drive

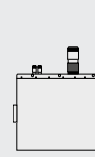

eMobility Drive

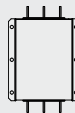

EMC & THD Filter

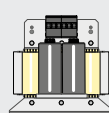

Sine Wave Filter

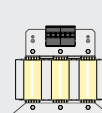

Motor Choke

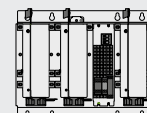

Sine Wave EMC Filter

MOTORS



AC Motor



PM Motor



PM Gear Motor



AC Gear Motor

BRAKES & CLUTCHES



Permanent Magnet Brake



Spring Applied Brake



Electromagnetic Brake



Electromagnetic Clutch

COMBIVERT S6 – BENEFITS AT A GLANCE

OPTIMALLY SELECTED COMPONENTS

The COMBIVERT S6 servo system adds a compact, flexible and powerful drive module to the KEB product portfolio for highly dynamic servo applications. The optimally selected KEB components are the key to this successful drive concept.

- At the heart, the innovative S6 servo drive is offered in an attractive book-style format and offers real-time performance. The S6 drives can be matched with the robust DL3 servo motors which are available in five sizes. Additionally, the DL3 servo motors may be paired with planetary gearheads with low rotational backlash.
- The TA series combines in direct connection the servo motor and industrial gears in the designs helical, helical bevel, helical worm and flat. You can now design the complete servo drive system that is best suited to your application.



DRIVE BASED SAFETY

POWERFUL

- Functional consistency across the entire power range
- 2,6 A ... 16 A in two housing sizes
- Book format for space-saving cabinet configuration
- Direct mains connection for 230 V and 400 V networks, alternatively also DC input 260 V ... 375 / 750 V
- Low leakage current mains filter (<5 mA) integrated, optionally without filter
- High overload for optimum dynamics (250 % / 3 s, 200 % / 60 s)
- Integrated safety technology
- Wide range of options for motors, encoders and communication

DRIVE BASED SAFETY

Integrated safety functionality:

- Basic function STO in COMPACT variant
- Additional modular high level safety in APPLICATION variant
- Encoderless safety in variant PRO

REAL-TIME COMMUNICATION

- Real-time Ethernet-based interfaces
 - CAN
- or simply serial:
- RS232 / 485 for diagnostics or display

ALL IN ONE – UNIVERSAL MOTOR OPERATIONS

For asynchronous, synchronous, IPM or synchronous reluctance motors

- With encoder or encoderless control: SCL and ASCL for precise speed control
- Motor temperature monitoring PTC, KTY or PT1000
- Two-channel multi-encoder interface
- Integrated brake transistor
- Integrated brake control

ANALOG / DIGITAL

Supports existing machine concepts with:

- 8 digital and 2 analogue inputs
- 2 digital outputs + 1 relay
- Analog output 0 V ... 10 V



HIGHLIGHTS

- Best speed and torque performance
- Modern real-time communication
- Integrated functional safety
- Particularly compact dimensions

COMBIVERT S6

MAINS CONNECTIONS

with pluggable terminals

FUNCTIONAL SAFETY

INTERFACE

CAN interface
Realtime Ethernet
Modbus

DC SUPPLY TERMINALS

and braking resistor

MOTOR TERMINALS

with pluggable terminals

I/O

8 digital inputs
2 digital outputs
1 relay
2 analog inputs
1 analog output
24V DC supply

DIAGNOSTIC INTERFACE

STATUS LEDS

configurable for APPLICATION
and PRO device variants

MULTI ENCODER INTERFACES

Resolver, EnDAT, Hiperface, BISS, SSI,
Incremental HTL / TTL,
Incremental output

MOTOR TEMPERATURE DETECTION

KTY / PTC / PT1000

BRAKE CONTROL 24 V / 2 A

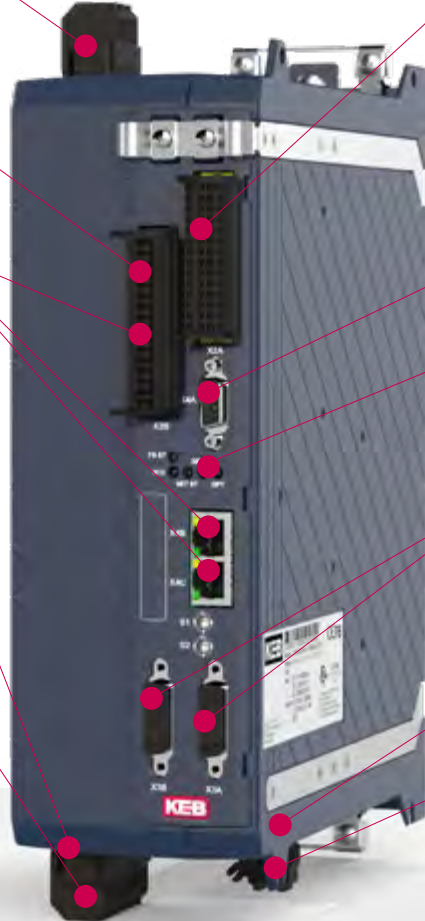

HIGHLIGHTS

- Compact and flexible servo system
- Highest performance in torque, speed and position control
- Uncompromising integration
- User-friendly
- Scalable safety functions

COMPACT
HIGHLY INTEGRATED
AND ECONOMICAL

STO

REALTIME ETHERNET

ETHERCAT OR VARAN

Communication interface

CAN
DIAGNOSTIC RS232 / 485

APPLICATION
MODULAR AND FLEXIBLE

STO, SBC and speed / position related safety functions

REALTIME ETHERNET

ETHERCAT
PROFINET
POWERLINK
ETHERNET / IP
MODBUS TCP

Communication interface

CAN
CAN CROSS-COMMUNICATION
DIAGNOSTIC RS232 / 485

PRO
ENCODERLESS SAFETY

STO, SBC and speed related safety functions without encoder feedback

REALTIME ETHERNET

ETHERCAT
PROFINET
MODBUS TCP

Communication interface

CAN
CAN CROSS-COMMUNICATION
DIAGNOSTIC RS232 / 485
ETHERNET
MODBUS RTU/ASCII



HIGHLIGHTS

- Brake handling
- Power-off
- DC-brake
- PID controller
- Round table function
- Recipe management
- Multi motor handling
- Anti cogging
- Etc.

SAFETY FUNCTIONS IN THE DRIVE

BASIS FOR SAFETY

COMPACT

In the COMPACT variant, the COMBIVERT F6 and S6 drive controllers are equipped with Safe Torque Off (STO).

SAFETY FUNCTIONS WITH SPEED AND POSITION MONITORING

APPLICATION

The device variant APPLICATION is available in two versions. In addition to STO, Module 1 adds Safe Brake Control (SBC) which provides a safe 24 V supply for the brakes.

Module 3 offers safe motion functionality according to IEC 61800-5-2 through speed and position detection using encoders. The error reaction time is shortened and costs are lowered by reducing the number of separate protective devices. Module 3 also offers the option of controlling all available safety functions and limit values via Safety over EtherCAT (FSoE) or PROFIsafe.

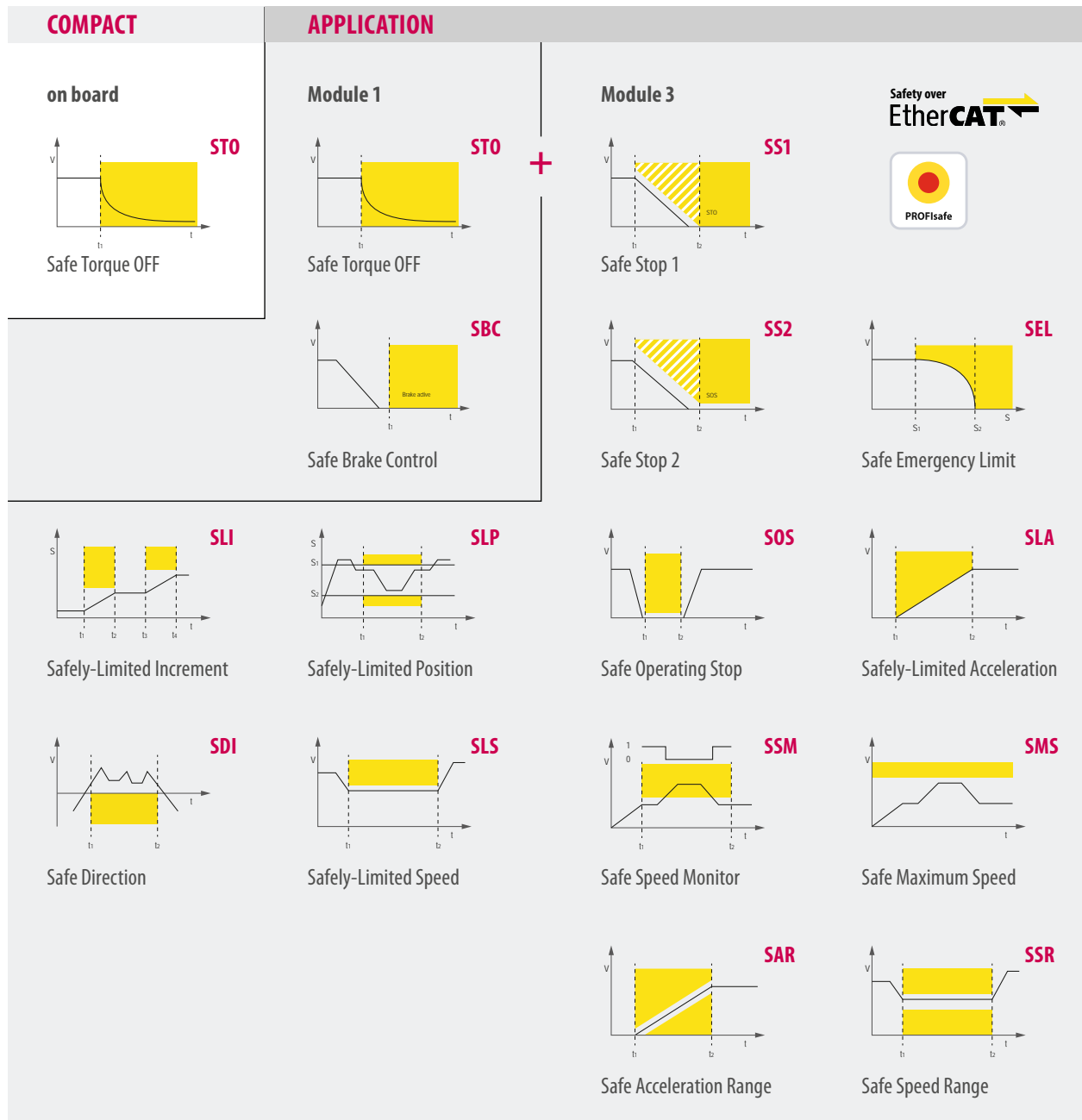

ENCODERLESS SAFETY FUNCTIONS

PRO

The PRO device variant of the COMBIVERT F6 and S6 drive controllers offers advanced safety functions without having to use a safety encoder. The device determines the safe velocity parameters from the pulse width modulation (PWM) of the motor supply.

In addition to STO, Module 5 is equipped with a safe brake control (SBC), which provides a safe 24 V supply for braking operation as well as a monitoring of the switching status of the brake via microswitch evaluation.

Module 5 also offers the option of controlling all available safety functions via Safety over EtherCAT (FSoE).

PRO

Module 5

Safety over EtherCAT

STO
Safe Torque OFF

SLS
Safely-Limited Speed

SS1
Safe Stop 1

SLA
Safely-Limited Acceleration

SMS
Safe Maximum Speed

SBC
Safe Brake Control

SSM
Safe Speed Monitor

SDLC
Safe Door-Lock Control



WHY USE DRIVE-BASED SAFETY (SAFE MOTION)?

- Less wiring – remove contactors and other traditional safety components
- Fast reaction – direct handling inside the drive
- Easy to operate – up to eight different safety setups per function
- Cost savings compared to traditional safety solution

COMBIVERT S6

ELECTRICAL PROPERTIES

HOUSING			2			4				
Device size			07	09	07	09	10	12	13	14
Mains phases			1		3					
Output rated current	I_N	[A]	4	7	2.6	4.1	5.8	9.5	12.0	16.5
Short maximum current (3 s / 60 s) ¹⁾	J_{SMC}	[%]	200 / 150		250 / 200					180 / 150
Output rated power *	S_A	[kVA]	1.8	2.8	1.8	2.8	4	6.6	8.3	11.4
Typical rated motor power	P_{mot}	[kW]	0.75	1.5	0.75	1.5	2.2	4.0	5.5	7.5
Nominal voltage (AC)			230		400					
Max. current 0 Hz / cutoff frequency at $f_s = 4$ kHz ¹⁾	I_0	[%]	175 / 240	157 / 240	215 / 300	193 / 300	155 / 284	273 / 300	283 / 300	133 / 216
Max. current 0 Hz / cutoff frequency at $f_s = 8$ kHz ¹⁾	I_0	[%]	150 / 240	114 / 228	162 / 292	132 / 234	103 / 206	189 / 294	183 / 293	109 / 212
Max. current 0 Hz / cutoff frequency at $f_s = 16$ kHz ¹⁾	I_0	[%]	100 / 200	85 / 200	92 / 200	73 / 146	50 / 120	105 / 189	116 / 175	60 / 127
Cutoff frequency point	f_d	[Hz]	6							
Input rated current	I_{IN}	[A]	8	14	3.6	6	8	13	17	21
Max. permissible mains fuses	Typ gG	[A]	15	20	6	10	10	15	20	25
Rated switching frequency	f_{SN}	[kHz]	8							
Max. switching frequency	f_{Smax}	[kHz]	16							
Rated losses	P_D	[W]	60	95	50	57	80	155	185	250
Standby losses	P_{Dnop}	[W]	8							
Min. brake resistance	R_{Bmin}	[Ω]	56	33	160	110	82	33	25	25
Max. braking current	I_{Bmax}	[A]	7.5	12.7	5.5	8	11	28	34	34
Input rated voltage (AC)	U_N	[V]	1-phase 230			3-phase 400 (UL: 480)				
Input voltage range (AC) ²⁾	U_{in}	[V]	184 ... 265			184 ... 550 ±0				
Input voltage range (DC)	U_{indc}	[V]	260 ... 375			260 ... 750 ±0				
Mains frequency	f_N	[Hz]	50 / 60			50 / 60 ±2				
Output voltage	U_A	[V]	3 x 0 ... U_{IN}							
Output frequency	f_A	[Hz]	0 ... 599 optional 0 ... 2,000							

* At nominal voltage 230 V / 400 V AC

¹⁾ The figures relate to the output rated current I_N on a percentage basis

²⁾ In the case of rated voltage ≥ 460 V, multiply rated current with a factor of 0.86

OPERATING TYPES, STANDARDS

OPERATING MODES

Motor control mode	PMSM: field-oriented with encoder, SCL encoderless IPMSM: field-oriented with encoder, SCL encoderless SynCRM: field-oriented with encoder, SCL encoderless ASM: V / F, field-oriented with encoder, ASCL encoderless
Application profile	CiA 402
Control mode	Velocity Mode Cyclic Synchronous Velocity Mode Cyclic Synchronous Torque Mode Cyclic Synchronous Position Velocity Mode Profile Position Mode Homing Mode Jog Mode

GENERAL

Product standard	EN 61800-2, -5-1
EMC transient emissions	
Grid-bound disturbance	EN 61800-3, C2 - 1-ph: 30 m - 3-ph: 50 m motor cable length (shielded), low-capacitance
Emitted disturbances	EN 61000-6 -1...4, C2
Protection class	IP 20 / VBG 4
Environment	EN 60721-3-3 Operating temperature -10 ... 45 °C Storage temperature -25 ... 55 °C Humidity 3K3 - 5 ... 85 % (no condensation)
Site altitude	max. 2,000 m above sea level, from 1,000 m: power reduction of 1 % per 100 m

HOUSING	2	4
H1	265	265
H2	275	275
H3	310	310
D	220	220
W	50	90

All dimensions in mm

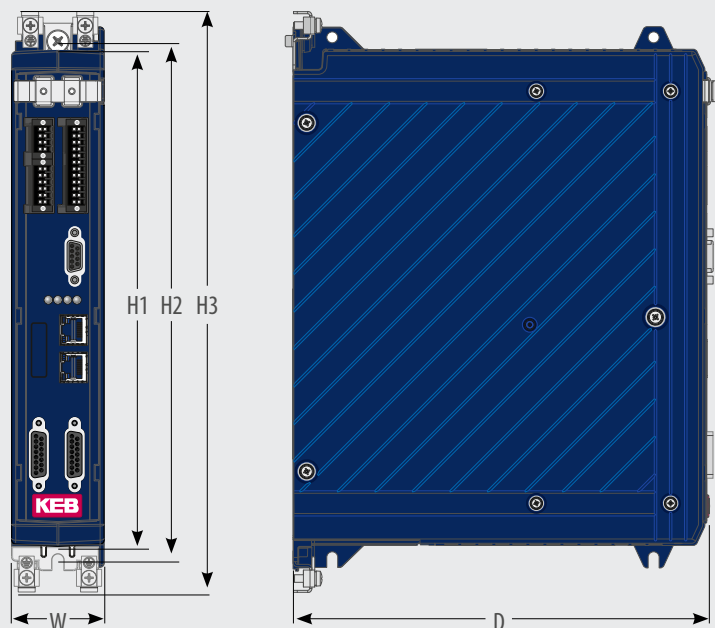

SERVO MOTORS

SERVOMOTORS DYNAMIC LINE 3

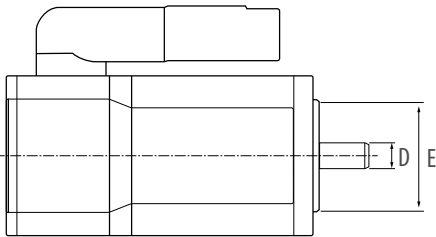
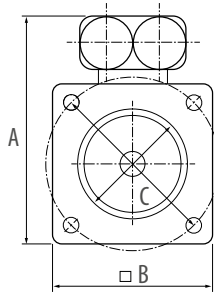

O_SMH_	0.2 ... 0.5
A_SMH_	0.5 ... 1.2
B_SMH_	1.4 ... 3.2
C_SMH_	2.6 ... 5.7
D_SMH_	4.9 ... 11.4
E_SMH_	12.8 ... 29.0

Stall torque in Nm

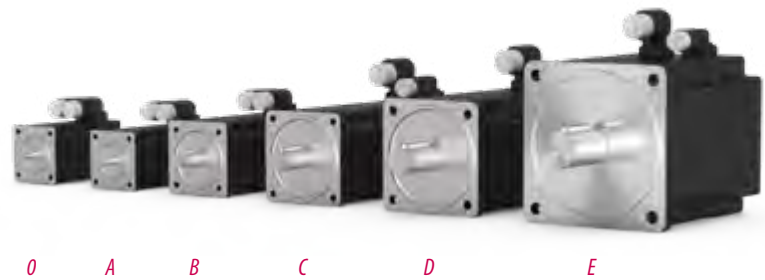

MOTOR	T ₀ [Nm]	T _N [Nm]	U _N [V]	I _{D0} /I _N [A]	N _N [min ⁻¹]	A [mm]	B [mm]	C [mm]	D [mm]	E [mm]	OPTION BRAKE	INERTIA
											T _n [Nm]	JM / J _{MwBr} [kgcm ²]
O1	0.2	0.18	230	0.76 / 0.73	8,000	65.4	40	46	8	30	0.6	0.0294 / 0.0521
O2SMHF_	0.38	0.33		1.3 / 1.2								0.0482 / 0.0709
O3	0.52	0.45		1.65 / 1.3								0.0670 / 0.0897
A1	0.5	0.5	400	0.85	5,000	128.5	87	100	19	80	9	0.134 / 0.205
A2SMHF_	0.8	0.7		1.50 / 1.30								0.253 / 0.324
A3	1.2	1.0		2.20 / 1.85								0.373 / 0.444
B1	1.4	1.3	400	1.95 / 1.90	6,000	96.4	72	75	14	60	2	0.462 / 0.541
B2SMHF_	2.4	2.2		2.95 / 2.75								0.842 / 0.921
B3	3.2	2.7		4.10 / 3.60								1.22 / 1.46
C1	2.5	2.3	400	3.00 / 2.90	5,000	145.5	104	115	24	95	9	1.08 / 1.74
C2SMHF_	4.1	3.7		4.10 / 3.80								1.98 / 2.63
C3	5.7	4.9		5.40 / 4.75								2.87 / 3.52
D1	4.9	4.4	400	4.75 / 4.20	4,000	183.5	142	165	32	130	9	2.23 / 2.89
D2SMHF_	8.2	6.9		6.30 / 5.20								4.06 / 4.72
D3	11.4	8.4		8.80 / 6.30								5.88 / 7
E1	12.8	11.0	400	7.80 / 6.80	3,000	183.5	142	165	32	130	20	11.1 / 1.34
E2SMHF_	21.1	15.2		12.4 / 9.40								20 / 22.3
E3	29.0	13.2		17.2 / 8.10								29 / 34.9



HIGHLIGHTS

- 0.2 Nm ... 29 Nm in six frame sizes
- Low inertia – high impulse torque
- Resolver or absolute rotary encoder, HIPERFACE single or multi-turn
- High degree of total efficiency
- Lifetime lubricated
- Universal installation positions
- Robust mechanics (optional: COMBIPERM holding brake, keyway with key, IP65 shaft sealing)

PLANETARY GEAR SG PAIRED WITH DYNAMIC LINE 3

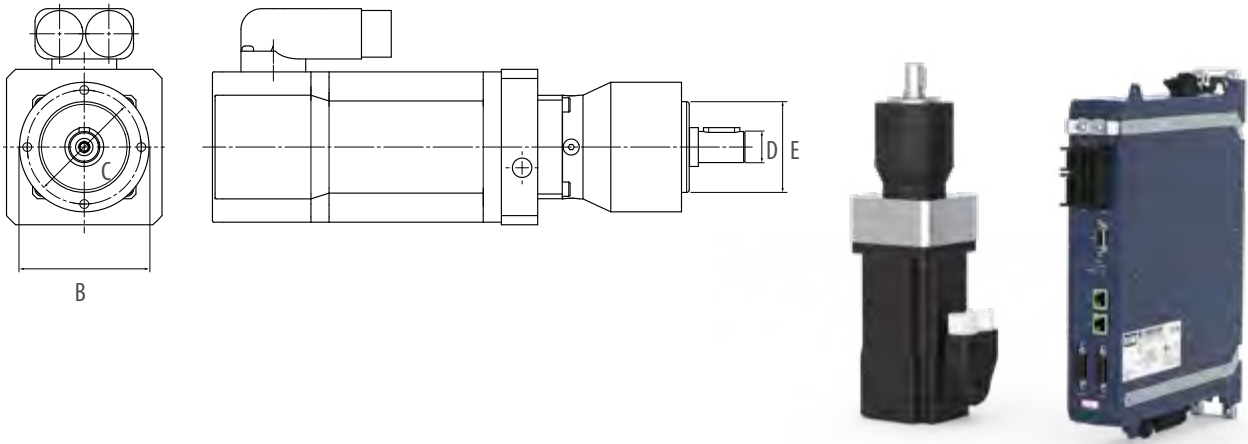

GEAR SIZE	T _{2N} [Nm]	T _{2MAX} [Nm]	N _{MAX} [rpm]	I	BACKLASH arc _{min}	B Ø [mm]	C Ø [mm]	D Ø [mm]	E Ø [mm]	DL3-MOTOR recommended
1	5 ... 11	8 ... 17.5	5,000	5 ... 40	15	50	44	12	35	A
2	15 ... 28	24 ... 45	4,500		10	70	62	16	52	A B C
3	38 ... 85	61 ... 136	4,000		7	90	80	22	68	A B C D
5	95 ... 115	152 ... 136	3,000		7	120	108	32	90	B C D E
7	210 ... 460	336 ... 736	2,800		8	155	140	40	120	C D E



HIGHLIGHTS

- Low backlash
- High output torque
- High efficiency (97 %)
- Gear ratios i = 5 to 40
- Low audible noise
- Lifetime lubricated

SERVO GEAR MOTORS

INTEGRATED SERVO DESIGN

Based on the industrial standard with AC motors the portfolio of COMBIGEAR series offers a full basket of servo gear solutions. The dynamic and efficient TA servo motors are direct connected in the first gear stage – best choice for minimum lengths, nearly zero wear and small inertia of the gear motor system.

Flexible designs for flange-, foot-, or combined flange / foot- mounting and a wide range of options secure individual needs in the machine. Ultra-fine speed ratio range, adjustable down to speed 0, enables optimum adaptation of torque and speed on output. Life-time lubrication, high overload and low torsional backlash ensure a long service life.

TYPE	SIZE	DESIGN	T_n [Nm]	I	TA1	TA2	TA3	TA4	TA5
G	0 ... 7	Helical gear	60 ... 4,880	3.37 ... 250.97	■	■	■	■	■
F	2 ... 7	Shaft mounted helical gear	245 ... 4,880	3.20 ... 274.23		■	■	■	■
K	0 ... 7	Helical bevel gear	58 ... 4,880	3.38 ... 183.21	■	■	■	■	■
S	0 ... 4	Helical worm gear	55 ... 1,160	5.09 ... 247.58	■	■	■	■	■

HELICAL GEAR

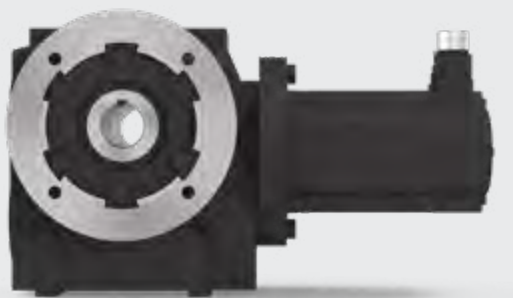

HELICAL WORM GEAR



HELICAL BEVEL GEAR

SHAFT MOUNTED HELICAL GEAR



TA SERIES

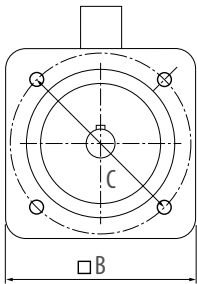

TA 1	0.5 ... 0.9
TA 2	1.3 ... 3.3
TA 3	2.9 ... 6.8
TA 4	6.9 ... 11,7
TA 5	11.5 ... 20.0

Stall torque in Nm

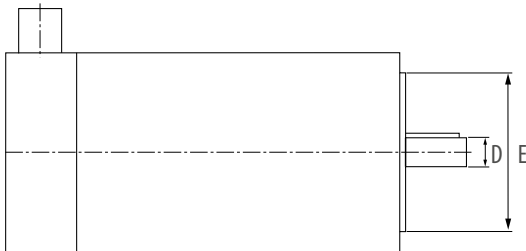

MOTOR	T_0	U_N	I_{D0}	N_N	B	C	D	E	OPTION BRAKE	INERTIA
	[Nm]	[V]	[A]	[min ⁻¹]	[mm]	[mm]	[mm]	[mm]	T_n [Nm]	J_M / J_{MwBr} [kgcm ²]
TA1S	0.5	400	0.95 / 0.72	6,000 / 4,500	58	63	9	40	2	0.14 / 0.2
TA1M	0.9		1.11 / 0.84							0.2 / 0.27
TA2S	1.4		1.6 / 1.1	6,000 / 4,500	75	75	11	60	2	0.39 / 0.46
TA2M	2.4		2.75 / 2							0.66 / 0.73
TA2L	3.3		3.9 / 2.8							0.93 / 0.99
TA3S	2.9		3.4 / 2.5 / 1.82	6,000 / 4,500 / 3,000	90	100	14	80	4,5	1.13 / 1.32
TA3M	4.9		6.2 / 4.1 / 2.55							1.95 / 2.13
TA3L	6.8		7.3 / 5.6 / 3.8							2.76 / 2.94
TA41	6.9		6.5 / 4.45 / 3.15	4,500 / 3,000 / 2,000	116	115	19	95	9	5.65 / 5.83
TA42	9.2		8.5 / 5.9 / 4							8.15 / 8.69
TA43	11.7	11.2 / 7.3 / 5	10.65 / 11.19							
TA51	11.5	11 / 7.4 / 5	4,500 / 3,000 / 2,000	145	165	24	130	18	14.97 / 16.63	
TA52	16.1	15.8 / 10.3 / 6.9							21.53 / 23.19	
TA53	20	19.2 / 12.8 / 8.7							28.15 / 29.81	

further technical data and motor sizes see KEB-Drive product configuration



HIGHLIGHTS

- 0.5 Nm ... 90 Nm in five frame sizes
- Low inertia – high impulse torque
- Easy plug connection, straight or angled (360° rotatable)
- Compact size - directly integrated in the gear modules
- High total efficiency, lifetime lubricated, universal installation positions and robust mechanics
- Resolver or absolute rotary encoder, BiSS single and multi-turn
- Optionally with COMBIPERM holding brake

SERVO MOTORS

DL3 CABLES FEEDBACK AND POWER CABLES

Pre-fabricated motor and encoder cables ensure the easy commissioning and simplify the final installation. General performance is the high-quality and flexible design for all cables, made for drag chains. Quick and tool-less installation with Speedtec plug connectors guarantees an optimally connected and EMC shielded connection.



RESOLVER FEEDBACK CABLES

- motor side connector - series 615
- drive side connector D-sub 26 pin

00S6L50-00

cable length	1 ... 30 m	in 1 m steps
	35 ... 50 m	in 5 m steps

HIPERFACE FEEDBACK CABLES

for single and multi turn encoders

- motor side connector - series 615
- drive side connector D-sub 26 pin

00S6L55-00

cable length	1 ... 30 m	in 1 m steps
	35 ... 50 m	in 5 m steps

MOTOR CONNECTION CABLES

- motor side connector - series 615 motor sizes 01 ... 03 and A ... B
- drive side open end with 0.3 m open shielding

00H6L10-00

cable length	1 ... 30 m	in 1 m steps
	35 ... 50 m	in 5 m steps

- motor side connector - M23 speedtec motor size C - E

00S4519-00

cable length	1 ... 30 m	in 1 m steps
	35 ... 50 m	in 5 m steps



HIGHLIGHTS

- Pre-fabricated motor and encoder cables for easy installation
- High-quality and flexible design for cable drag chains
- Quick and tool-less installation with Speedtec plug connectors
- Optimally integrated shield connection
- Available in lengths up to 50 metres

TA CABLES FEEDBACK AND POWER CABLES

Prepared for the direct connection:



RESOLVER FEEDBACK CABLES

- motor side connector - 12 pin M23 - Speedtec
- drive side connector D-sub 26 pin

00S6L50-10__

cable length	1 ... 30 m	in 1 m steps
	35 ... 50 m	in 5 m steps

BISS FEEDBACK CABLES

for multi turn encoders

- motor side connector - 17 pin M23 - Speedtec
- drive side connector D-sub 26 pin

00S6L51-20__

cable length	1 ... 30 m	in 1 m steps
	35 ... 50 m	in 5 m steps

HIPERFACE FEEDBACK CABLES

for single and multi turn encoders

- motor side connector - series 615
- drive side connector D-sub 26 pin

00S6L55-10__

cable length	1 ... 30 m	in 1 m steps
	35 ... 50 m	in 5 m steps

MOTOR CONNECTION CABLES

- motor side connector - M23 - speedtec for motor size TA2...TA5
- drive side open end with 0.3 m open shielding

00S4519-00__

cable length	1 ... 30 m	in 1 m steps
	35 ... 50 m	in 5 m steps

ENCODER CABLE FOR MASTER/SLAVE OPERATION

- Angle and speed-synchronised master/slave operation of two drives via encoder interface
- Available for the APPLICATION and PRO device variants

00S6L57-0001

Cable length	1 m
--------------	-----

ACCESSORIES

MAINS CHOKE

Mains chokes reduce the input peak current draw and the mains distortion. By smoothing the input current draw, the lifetime of the drive is enhanced, in particular at constantly high utilisation.

MAINS CHOKE 1- AND 3-PHASE 230/400 VAC, 50 Hz / 60 Hz

Part-No.	Supply voltage	U_{max} [V]	I_N [A]	P_V [W]	f_{mains} [Hz]	B [mm]	H [mm]	T [mm]	weight m [kg]
07Z1B02-1000	1-ph 230 V	264	10	9	45-65	85	59.5	89	1.4
09Z1B02-1000	1-ph 230 V	264	16	15	45-65	85	60	89	1.5
07Z1B03-1000	3-ph 230 V	264	4.2	20	45-65	100	54	120	0.9
09Z1B03-1000	3-ph 230 V	264	7.4	26	45-65	100	54	122	1.1
10Z1B03-1000	3-ph 230 V	264	10.5	28	45-65	100	63	122	1.5
12Z1B03-1000	3-ph 230 V	264	17.3	52	45-65	148	67	145	2
13Z1B03-1000	3-ph 230 V	264	25.2	55	45-65	148	77	145	3.7
07Z1B04-1000	3-ph 400 V	550	2.7	19	45-65	100	55	121	0.9
09Z1B04-1000	3-ph 400 V	550	4.3	23	45-65	100	55	121	1.1
10Z1B04-1000	3-ph 400 V	550	6.1	24	45-65	100	64	121	1.5
12Z1B04-1000	3-ph 400 V	550	10	37	45-65	148	68	145	2.1
13Z1B04-1000	3-ph 400 V	550	12.6	48	45-65	148	78	145	2.6
14Z1B04-1000	3-ph 400 V	550	17.3	69	45-65	148	77	145	2.8

BRAKING RESISTOR

Braking resistors can be connected to the series terminals of the brake transistor, and ensure that energy peaks are absorbed and discharged. The compact design require only small space and they are intrinsically safe; without additional temperature sensors.

To protect against overheating and fire hazards, the brake resistors feature thermal monitoring which can be integrated into the external circuit.

BRAKING RESISTOR

Part Number	P_D [W]	R [Ω]	B [mm]	H [mm]	D [mm]	Wire [m]	Protection class
10G6A90-4300	200	160	220	90	31	0.2	IP40
13G6B90-4300	250	110	285	90	31	0.2	IP40
15G6C90-4300	300	56	295	120	31	0.2	IP40
07BR6B1-5390	35	390	90	10	220	0.25	IP20
09BR6B1-5270	35	270	90	10	220	0.25	IP20
12BR6B1-5150	35	150	90	10	220	0.25	IP20
12BR6D1-5150	50	150	90	10	250	0.25	IP20
14BR6D1-5853	50	85	90	10	250	0.25	IP20
14BR6E1-5853	100	85	130	10	290	0.25	IP20
16BR6E1-5423	100	42	130	10	290	0.25	IP20

Braking resistors for higher power ratings (BR100, BR110 & BR226 series) are also available in the "non-intrinsically safe" version.



COMBIVIS 6 – THE TOOL FOR ALL TASKS

COMBIVIS 6

Commissioning software for parameterisation, diagnostics and project management

- Free and easy-to-use software for commissioning, management and analysis
- Direct access to device documentation
- 16-channel oscilloscope for comprehensive analyses, 4 channels of which can be displayed in the drive's control grid
- Online and offline parameter list comparison/Quick Compare Mode
- Parameterisation of safety parameters and functions

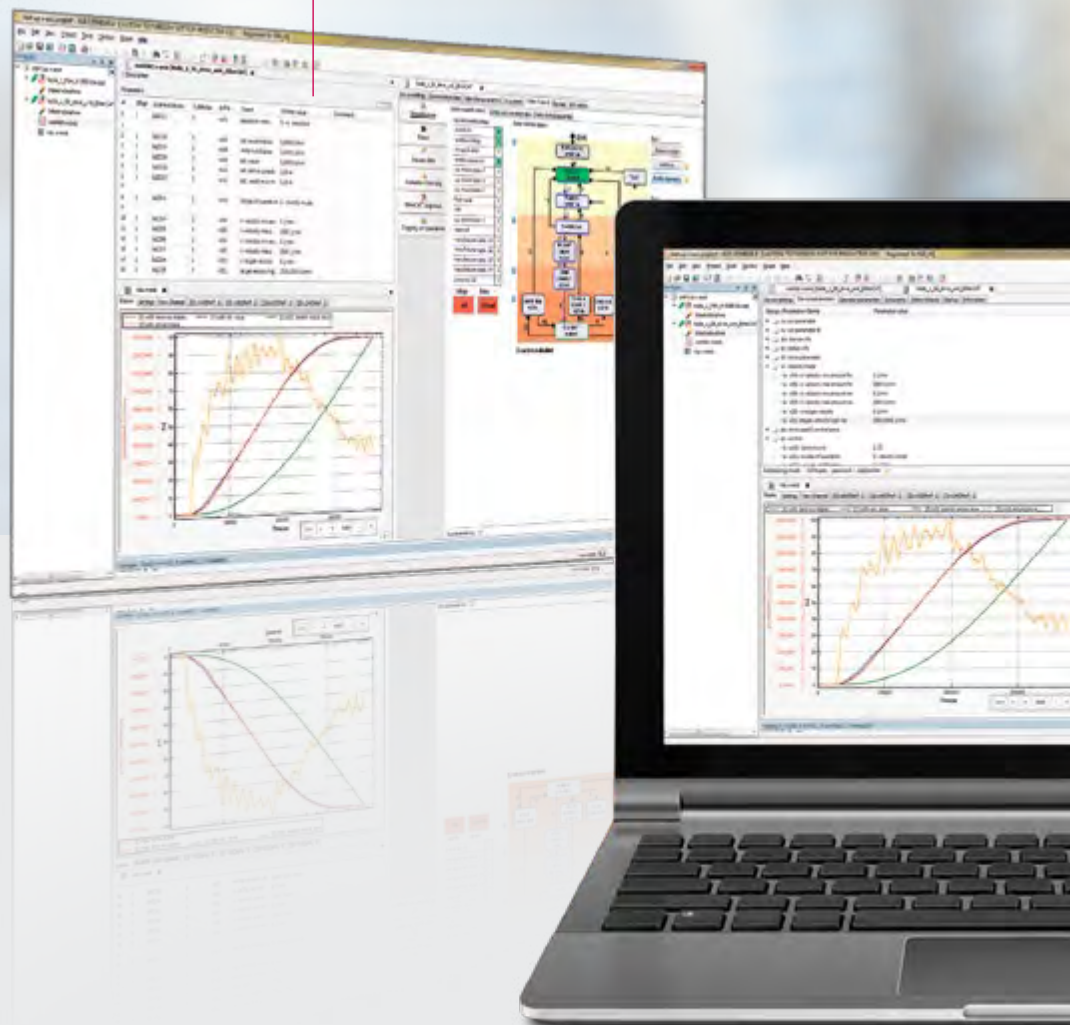

COMBIVIS studio 6

The intelligent automation suite from KEB combines an assistant-guided component selection, fieldbus configuration, drive parameterisation, IEC 61131-3 project generation and motion control. Throughout the planning and layout phase, implementation of control sequences and multi-axis movement profiles, to start-up and fine tuning, the user is supported by a tool developed by experienced application engineers. With a foundation built on libraries, devices and template databases, rapid and simple solutions can be generated for a wide range of applications.

COMMISSIONING ASSISTANT

- Complete user guidance through the commissioning process
- KEB Motor database, freely expandable
- Anti cogging
- Fieldbus diagnostic and optimisation
- Sine filter wizard
- Servo pump wizard

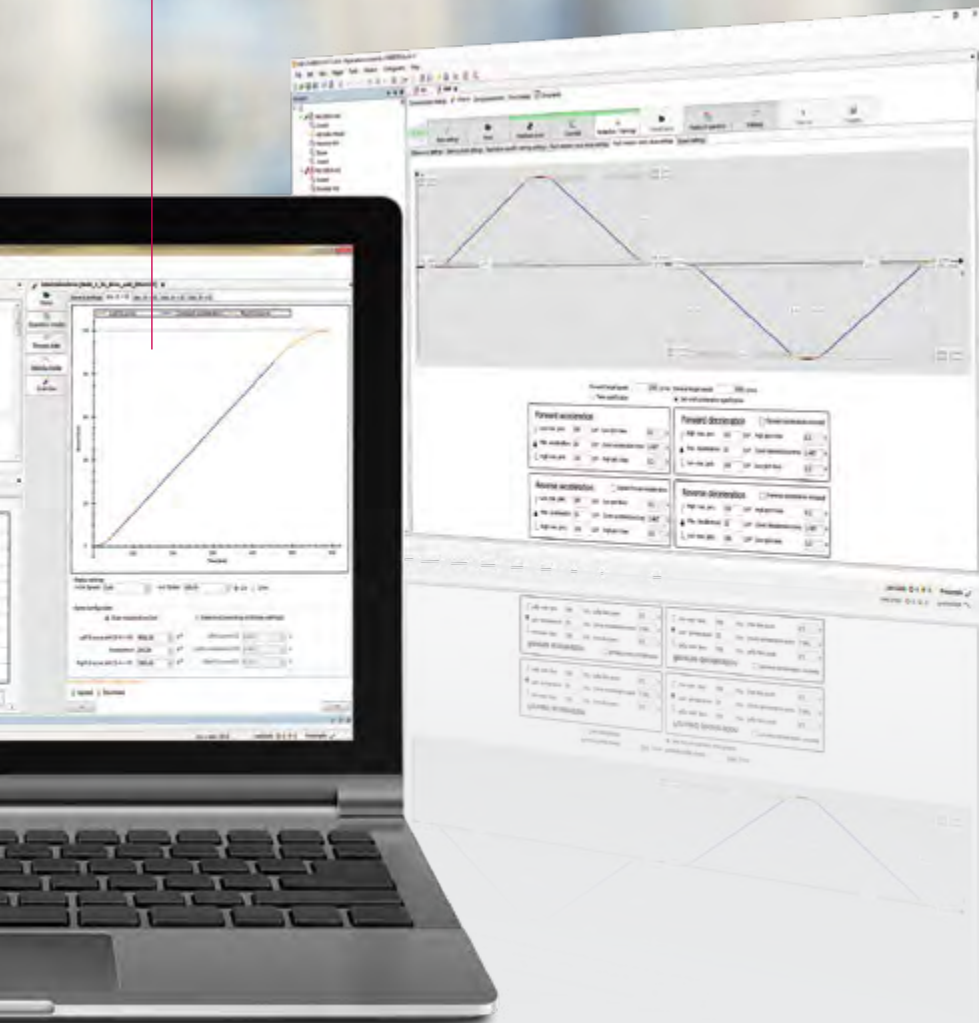

HIGHLIGHTS

- IEC 61131-3 Applications development
- Start-up and diagnosis assistant
- COMBIVIS studio HMI integration
- Document database

KEB SERVICE

PERFORMANCE AND COMPETENCE

CUSTOMER SUPPORT IN THE AFTER-SALES AREA

- Commissioning
- Troubleshooting
- EMC service
- Network analysis
- Insulation, heat or vibration measurements
- Online service portal
- 'As Good As New' option
- Retrofit solutions

MAINTENANCE AND REPAIRS

- Express or standard service

STOCKPILING OF COMPONENTS

- Spare and used parts warehouse

PREVENTIVE MAINTENANCE

- Forming and cleaning
- Inspection
- Functional analysis

CUSTOMISED SERVICE

- Customised service support
- System optimisation



KEB WORLDWIDE

Austria | KEB Automation GmbH

Ritzstraße 8 4614 Marchtrenk Austria
 Phone: +43 7243 53586-0 Fax: +43 7243 53586-21
 E-Mail: info@keb.at Web: keb-automation.com

Benelux | KEB Automation KG

Boulevard Paepsem 20 – Paepsemiaan 20 1070 Anderlecht Belgium
 Phone: +32 2 447 8580
 E-Mail: info.benelux@keb.de Web: keb-automation.com

Canada | KEB Canada

2010 Winston Park Dr., Suite 200 Oakville, ON L6H 5R7 Canada
 Phone: +1 905 617 2352
 E-Mail: sales@keb-automation.ca Web: keb-automation.ca

Czech Republic | KEB Automation s.r.o.

Videnska 188/119d 61900 Brno Czech Republic
 Phone: +420 544 212 008
 E-Mail: info@keb.cz Web: keb-automation.com

France | Société Française KEB SASU

Z.I. de la Croix St. Nicolas 14, rue Gustave Eiffel
 94510 La Queue en Brie France
 Phone: +33 149620101 Fax: +33 145767495
 E-Mail: info@keb.fr Web: keb-automation.com

Germany | Geared Motors

KEB Antriebstechnik GmbH
 Wildbacher Straße 5 08289 Schneeberg Germany
 Phone: +49 3772 67-0 Fax: +49 3772 67-281
 E-Mail: info@keb-drive.de Web: keb-automation.com

Italy | KEB Italia S.r.l. Unipersonale

Via Newton, 2 20019 Settimo Milanese (Milano) Italy
 Phone: +39 02 3353531 Fax: +39 02 33500790
 E-Mail: info@keb.it Web: https://blog.keb.it

Japan | KEB Japan Ltd.

711-103 Fukudayama, Fukuda,
 Shinjo-shi Yamagata 996-0053 Japan
 Phone: +81 233 292800 Fax: +81 233 292802
 E-Mail: info@keb.jp Web: keb.jp

P. R. China | KEB Power Transmission Technology (Shanghai) Co. Ltd.

No. 435 QianPu Road Chedun Town Songjiang District
 201611 Shanghai P. R. China
 Phone: +86 21 37746688 Fax: +86 21 37746600
 E-Mail: info@keb.cn Web: keb.cn

Poland | KEB Automation KG

Phone: +48 604 077 727
 E-Mail: roman.trinczek@keb.de Web: keb-automation.com

Republic of Korea | KEB Automation KG

Deoksan-Besttel 1132 ho Sangnam-ro 37
 Seongsan-gu Changwon-si Gyeongsangnam-do Republic of Korea
 Phone: +82 55 601 5505 Fax: +82 55 601 5506
 E-Mail: vb.korea@keb.de Web: keb-automation.com

Spain | KEB Automation KG

c / Mitjer, Nave 8 - Pol. Ind. LA MASIA
 08798 Sant Cugat Sesgarrigues (Barcelona) Spain
 Phone: +34 93 8970268
 E-Mail: vb.espana@keb.de Web: keb-automation.com

Switzerland | KEB Automation AG

Barzloostrasse 1 8330 Pfaeffikon/ZH Switzerland
 Phone: +41 43 2886060
 E-Mail: info@keb.ch Web: keb-automation.com

United Kingdom | KEB (UK) Ltd.

5 Morris Close Park Farm Industrial Estate
 Wellingborough, Northants, NN8 6XF United Kingdom
 Phone: +44 1933 402220 Fax: +44 1933 400724
 E-Mail: info@keb.co.uk Web: keb-automation.com

United States | KEB America, Inc.

5100 Valley Industrial Blvd. South
 Shakopee, MN 55379 United States
 Phone: +1 952 2241400 Fax: +1 952 2241499
 E-Mail: info@kebameric.com Web: kebameric.com



KEB PARTNERS WORLDWIDE

... <https://www.keb-automation.com/contact>



Automation with Drive

keb-automation.com

KEB Automation KG Südstrasse 38 32683 Barntrop Germany Tel. +49 5263 401-0 E-Mail: info@keb.de

© KEB 0000000-5156 01.2025 Subject to technical alterations!