



Instruction for use

# C6 COMPACT 3

Installation

Translation of the original manual

Document 20372037 EN 02

## Imprint

KEB Automation KG  
Suedstraße 38, D-32683 Bartrup  
Germany  
Tel: +49 5263 401-0 • Fax: +49 5263 401-116  
E-Mail: [info@keb.de](mailto:info@keb.de) • URL: <https://www.keb-automation.com>

ma\_ca\_c6-compact3-inst-20372037\_en  
Version 02 • Edition 04/02/2025

# Table of contents

<b>1</b>	<b>Introduction .....</b>	<b>9</b>
1.1	Markings.....	9
1.1.1	Warnings.....	9
1.1.2	Information notes .....	9
1.1.3	Symbols and markers .....	10
1.2	Laws and guidelines.....	10
1.3	Warranty and liability.....	10
1.4	Support.....	10
1.5	Copyright.....	11
1.6	Open Source Information .....	11
1.7	Validity of this manual .....	12
1.8	Target group.....	12
<b>2</b>	<b>General Safety Instructions.....</b>	<b>13</b>
2.1	Installation .....	13
<b>3</b>	<b>Product description .....</b>	<b>14</b>
3.1	Scope of delivery.....	14
3.2	Product features.....	14
3.2.1	Fieldbus interfaces.....	15
3.2.2	Ethernet protocols.....	15
3.2.3	Programming and visualisation .....	16
3.2.4	Flash memory .....	16
3.3	Product identification.....	17
3.3.1	Type code .....	17
3.4	Intended use .....	17
3.5	Unintended use .....	17
3.6	Description of the device.....	18
3.6.1	Front view .....	18
3.6.2	Top view .....	19
3.6.3	View from below .....	20
3.6.4	Rear view all models.....	22
3.6.5	Nameplate .....	23
<b>4</b>	<b>Technical data .....</b>	<b>24</b>
4.1	Operating conditions .....	24
4.1.1	Climatic ambient conditions .....	24
4.1.2	Mechanical ambient conditions.....	24
4.1.3	Electrical operating conditions .....	24
4.2	Electrical data.....	25
<b>5</b>	<b>Assembly .....</b>	<b>26</b>
5.1	Assembly instructions .....	26
5.2	Dimensions .....	27
5.3	Mounting direction.....	27
5.4	Minimum installation distances .....	28
5.5	Mounting of the control.....	28
5.5.1	Mounting on a mounting rail .....	29
5.5.2	Disassembly of the mounting rail .....	29

<b>6</b>	<b>Electrical installation .....</b>	<b>30</b>
6.1	Assembly of wires .....	30
6.2	Voltage supply.....	31
6.2.1	Terminal block X6 .....	31
6.3	Earthing.....	32
6.4	Equipotential bonding.....	32
6.5	EtherCAT Master X1 .....	33
6.6	Ethernet X2 .....	33
6.7	Ethernet X3 .....	34
6.8	CAN.....	35
6.9	RS485 .....	37
6.10	RS232 .....	38
6.11	INTERBUS interface X10, X11 .....	38
6.11.1	INTERBUS DIP switch S1 .....	39
6.11.2	INTERBUS remote bus cable .....	39
<b>7</b>	<b>Operation .....</b>	<b>40</b>
7.1	Status displays .....	40
7.2	Start-up .....	42
7.2.1	Requirements for start-up .....	42
7.2.2	Find COMPACT 3 in the network .....	42
7.2.3	Login .....	43
7.2.4	Starting the web interface .....	43
7.2.5	Logout.....	45
7.3	System Manager .....	46
7.3.1	Overview .....	46
7.3.2	Network.....	47
7.3.3	Date and time .....	47
7.3.4	Partitions .....	48
7.3.5	Log files .....	48
7.3.6	Device LEDs .....	49
7.4	Licence Manager.....	49
7.4.1	My licences .....	49
7.5	App Manager.....	50
7.5.1	Installed apps.....	50
7.6	IIoT Cloud.....	51
7.6.1	Device manager.....	52
<b>8</b>	<b>Maintenance, service and disposal .....</b>	<b>54</b>
8.1	Maintenance.....	54
8.1.1	Cleaning.....	54
8.1.2	Flash memory .....	54
8.2	Service .....	54
8.3	Disposal .....	55
<b>9</b>	<b>Certification .....</b>	<b>56</b>
9.1	CE marking .....	56
9.1.1	EU Declaration of Conformity C6 COMPACT 3.....	57
9.2	UK marking .....	58
9.3	UL certification .....	59

<b>10 Revision History</b> .....	<b>60</b>
<b>Glossary</b> .....	<b>61</b>
<b>Index</b> .....	<b>63</b>

## List of figures

Fig. 1	C6 COMPACT 3 front view of models 1 and 3.....	18
Fig. 2	C6 COMPACT 3 front view model 2 .....	18
Fig. 3	C6 COMPACT 3 front view model 4 .....	19
Fig. 4	C6 COMPACT 3 top Model 1 and 2.....	19
Fig. 5	C6 COMPACT 3 top Model 3.....	20
Fig. 6	C6 COMPACT 3 top Model 4.....	20
Fig. 7	C6 COMPACT 3 bottom Model 1, 2 and 3.....	21
Fig. 8	C6 COMPACT 3 bottom Model 4.....	21
Fig. 9	C6 COMPACT 3 rear view .....	22
Fig. 10	Nameplate.....	23
Fig. 11	Dimensions COMPACT 3 .....	27
Fig. 12	Installation distances.....	28
Fig. 13	Mounting on a mounting rail.....	29
Fig. 14	Disassembly of the mounting rail .....	29
Fig. 15	RJ45 socket front view .....	33
Fig. 16	RJ45 socket front view .....	33
Fig. 17	RJ45 socket front view .....	34
Fig. 18	Connection CAN bus.....	36
Fig. 19	X10 INTERBUS input.....	38
Fig. 20	X11 INTERBUS output.....	39
Fig. 21	INTERBUS remote bus cable assignment.....	39
Fig. 22	find IP address .....	42
Fig. 23	Login NOA Edge .....	43
Fig. 24	Starting the NOA UI Hub.....	44
Fig. 25	Select the app and start .....	44
Fig. 26	Automatic logout .....	45
Fig. 27	System Manager overview.....	46
Fig. 28	System Manager - Network.....	47
Fig. 29	System Manager date and time .....	47
Fig. 30	System Manager - Partitions.....	48
Fig. 31	System Manager - Log-files .....	48
Fig. 32	System Manager - Device LEDs.....	49
Fig. 33	Licence Manager - My licences.....	49
Fig. 34	App Manager - Installed apps .....	50
Fig. 35	Open the app catalog.....	50
Fig. 36	Start installation of new apps .....	50
Fig. 37	Mark the app to be deleted .....	51
Fig. 38	Delete apps .....	51
Fig. 39	NOA Portal.....	52
Fig. 40	Open the device list.....	52
Fig. 41	Device manager with all installed devices.....	52

Fig. 42	Editing general information about the device .....	53
Fig. 43	Install, remove and update apps .....	53

## List of tables

Tab. 1	Wire end ferrules and stripping length .....	30
Tab. 2	Assignment of terminal block X6 .....	31
Tab. 3	PIN assignment RJ45 EtherCAT .....	33
Tab. 4	Function of the LEDs .....	33
Tab. 5	PIN assignment RJ45 Ethernet .....	33
Tab. 6	Function of the LEDs .....	34
Tab. 7	PIN assignment RJ45 Ethernet .....	34
Tab. 8	Function of the LEDs .....	34
Tab. 9	Assignment of terminal block X6 .....	35
Tab. 10	Assignment of terminal block X6 .....	37
Tab. 11	Assignment of terminal block X6 .....	38
Tab. 12	DIP switch 4-fold .....	39
Tab. 13	Specification INTERBUS remote bus cable .....	39
Tab. 14	SYS LED flashing pattern during boot process .....	40
Tab. 15	Flashing pattern SYS LED in operation .....	40
Tab. 16	Flashing pattern PLC LED .....	41
Tab. 17	Flashing pattern APP LED .....	41
Tab. 18	Flashing pattern SD LED .....	41
Tab. 19	Flashing pattern LD5 LED (USER mode) .....	41
Tab. 20	Flashing pattern BUS LED .....	42
Tab. 21	Browser depending on the device .....	42



# 1 Introduction

The described devices, accessories, hardware and/or software are products of KEB Automation KG. The enclosed documents correspond to conditions valid at printing. Misprint, mistakes and technical changes reserved.

## 1.1 Markings

### 1.1.1 Warnings

Certain operations can cause hazards during the installation, operation or thereafter. There is safety information in the documentation in front of these operations.

Warnings contain signal words for the severity of the hazard, the type and/or source of the hazard, the consequence of non-compliance and the measures to avoid or reduce the hazard.

 **DANGER**



**Type and/or source of the hazard.**

**Leads to death or serious bodily injury if not observed.**

- a) Measures to avoid the hazard.
- b) Can be supplemented by an additional danger sign or pictogram.

 **WARNING**



**Type and/or source of the hazard.**

**May cause death or serious injury if not observed.**

- a) Measures to avoid the hazard.
- b) Can be supplemented by an additional danger sign or pictogram.

 **CAUTION**



**Type and/or source of the hazard.**

**May cause bodily injury if not observed.**

- a) Measures to avoid the hazard.
- b) Can be supplemented by an additional danger sign or pictogram.

**NOTICE**



**Type and/or source of the hazard.**

**Can cause damage to property if not observed.**

- a) Measures to avoid the hazard.
- b) Can be supplemented by an additional danger sign or pictogram.

### 1.1.2 Information notes



Indicates to the user a special condition, prerequisite, scope or simplification.



This is a reference to further documentation. The barcode is for smartphones, the following link is for online users or for typing.

 <https://www.keb-automation.com/search>



Notes on conformity for use in the North American or Canadian market.

### 1.1.3 Symbols and markers

✓	Condition
a)	Action step
⇒	Result or intermediate result
(≡▶ Reference ▶ 10])	Reference to a chapter, table or picture with page reference
ru21	Parameter name or parameter index
(🌐▶ )	Hyperlink
<Strg>	Control code
COMBIVERT	Lexicon entry

## 1.2 Laws and guidelines

KEB Automation KG confirms with the CE mark and the EU declaration of conformity that our device complies with the essential safety requirements.

The EU declaration of conformity can be downloaded on demand via our website.

## 1.3 Warranty and liability

The warranty and liability on design, material or workmanship for the acquired device is given in the general conditions of sale.



Here you will find our general sales conditions.

(🌐▶ <https://www.keb-automation.com/terms-conditions>)



Further agreements or specifications require a written confirmation.

## 1.4 Support

Through multiple applications, not every possible case has been taken into account. If you require further information or if problems occur which are not treated detailed in the documentation, you can request the necessary information via the local KEB Automation KG agency.

**The use of our units in the target products is beyond of our control and therefore exclusively the responsibility of the customer.**

The information contained in the technical documentation, as well as any support provided verbally, written or through testing, is made to the best of our knowledge and information regarding intended use of KEB products. However, due to technical changes, any information provided is considered non-binding and is subject to change. This also applies to any violation of industrial property rights of a third-party.

Selection of KEB units in view of their suitability for the intended use must be done by the user.

**Tests can only be carried out within the scope of the intended end use of the product (Application) by the Customer. They must be repeated, even if only parts of hardware, software or the unit adjustment are modified.**

## 1.5 Copyright

The customer may use the instructions for use as well as further documents or parts from it for internal purposes. Copyrights are with KEB Automation KG and remain valid in its entirety.

This KEB product or parts thereof may contain foreign software, incl. free and/or open source software. If applicable, the license terms of this software are contained in the instructions for use. The instructions for use are already available, can be downloaded from the KEB website or can be requested from the respective KEB contact person.

Other wordmarks and/or logos are trademarks (™) or registered trademarks (®) of their respective owners.

## 1.6 Open Source Information

- ✓ Only applies to devices with Linux operating system.
- ✓ This product contains software components.
  - a) We are obliged to point out that the following disclaimer applies to the GPL and LGPL components with regard to the rights holders:

This program is published in the hope that it will be useful, but **without any guarantee**; even without the implied warranty of **marketability** or **usability for a specific purpose**. Further information can be found in the GNU General Public Licence and the GNU Lesser General Public Licence.

For other open source components, the disclaimers of the rights holders in the respective licence texts apply.

The software components contained in this product that are licensed by the rights holder as free software or open source software under a GNU General Public Licence version or a GNU Lesser General Public Licence version or under another open source licence gives you the right to obtain the source code for the binary file. The copyright and the corresponding licence information can be found in the /usr/share/common-licenses folder on the device. The folder is shared and can be accessed from any other PC via the network.

You can obtain the source code for these software components from us on a data carrier (CD, DVD or USB stick) at cost price by sending a request with the order number **00C6DD0-CS01** to the following address within three years of delivery of the product by us:

KEB Automation KG  
Legal Department  
Südstrasse 38  
32683 Barntrup  
Germany

Please provide the following information:

Device name, software version information, serial number of the device, delivery date.

Then we will send you an invoice. After receipt of payment you will receive the data carrier with the source code.

## 1.7 Validity of this manual

These instructions for use are valid for the units specified in the product description. It can be supplemented by corresponding options or special designs. It contains:

- Safety instructions to be observed
- Information on intended use
- Description of the device
- Technical Data
- Installation
- Connection
- Operation
- Maintenance, service and disposal

## 1.8 Target group

The instructions for use is determined exclusively for electrical personnel. Electrical personnel for the purpose of this instruction manual must have the following qualifications:

- Knowledge and understanding of the safety instructions.
- Skills for installation and assembly.
- Start-up and operation of the product.
- Understanding of the function in the used machine.
- Detection of hazards and risks of the electrical drive technology.
- Knowledge of IEC 60364.
- Knowledge of national safety regulations (e. g. DGUV Regulation 3).
- Knowledge of automation technology.
- Knowledge of PCs and the used operating system.

## 2 General Safety Instructions

The products are developed and built according to the state of the art and recognized safety rules. Nevertheless, their use may create dangers to life and limb of the user or third parties or damage to the machine and other material property.

The following safety instructions have been created by the manufacturer for the area of electric drive technology. They can be supplemented by local, country- or application-specific safety instructions. This list is not exhaustive. Non-observance of the safety instructions by the customer, user or other third party leads to the loss of all resulting claims against the manufacturer.

### NOTICE

#### Hazards and risks through ignorance!

- a) Read the instructions for use.
- b) Observe the safety and warning instructions.
- c) Ask if something is unclear.

### 2.1 Installation

#### DANGER



#### Electrical voltage in the vicinity of the device!

##### Danger to life due to electric shock !

- ✓ This device is intended for installation in control cabinets or machines that can be operated under dangerous voltages. For any work on the device
- a) Switch off the supply voltage of the control cabinet or machine.
  - b) Secure it against switching on.
  - c) Wait until all drives has been stopped in order that no regenerative energy can be generated.
  - d) Never bridge upstream protective devices. Also not for test purposes.

### NOTICE



#### Use of suitable voltage sources!

##### Electric Shock!

- a) Only voltage sources with safe extra-low voltage in accordance with HD 60364-4-41 may be used.
- b) Ensure that the used voltage supplies have the appropriate overvoltage category for the application.
- c) The requirements listed for SELV and PELV circuits in HD 60364-4-41 must be complied with.
- d) With existing or newly-wired circuits the person installing the device or machine must ensure that the PELV requirements are met.
- e) Connections with higher voltages must be excluded.

### 3 Product description

The C6 COMPACT 3 is an integrated control for the automation of applications with low to medium complexity. The control concept is based on the Linux operating system and offers an open microservice architecture. Docker technology can be used to integrate and organise various software functions. The system is future-proof thanks to the use of the latest multicore technology and real-time-capable motion control - programmable via IEC 61131-3.

The C6 COMPACT 3 can be used for other tasks in addition to the actual machine automation. It can

- act as a gateway between a higher-level control and a programmable control system with KEB Motion functionality. among other things, an OPC UA server serves as an interface.
- be used as HMI server device. It realises communication with one or more third-party systems and enables browsers to provide content via a HMI server. The microservice architecture of the COMPACT 3 offers simple integration of various software components.

The basic version can be ordered in different hardware and software variants.

#### 3.1 Scope of delivery

The scope of delivery consists of:

C6 COMPACT 3

Terminal block X6

Check the contents of the packaging for visible transport damage and completeness.

If parts are damaged, contact your KEB representative. Do not install any parts damaged by the delivery.

#### 3.2 Product features

C6 COMPACT 3	Model 1	Model 2	Model 3	Model 4 INTERBUS	Optional variants
CPU	64-bit ARM® Cortex®-A53 1GHz Dual Core, single-core Cortex-R5F 800MHz, Single-core Cortex-M4F MCU 400MHz				
Operating system	Linux compact-v3				
Main memory (RAM)	1 GB LPDDR4				up to 2 GB
Internal memory (flash)	eMMC 4 GB				up to 128 GB
Memory card slot	microSD for memory expansion, backup and restore				
X1 10/100 Mbit/s	yes				
X2 10/100 Mbit/s	yes				
X3 10/100/1000 Mbit/s	-	yes	-	-	Option
CAN master/slave	-	-	yes	-	Option
INTERBUS interface	-	-	-	yes	Option
RS232	-	-	-	-	Option
RS485	-	-	-	-	Option
TPM	-	-	-	-	Option
Real-time clock - up to 30 days buffering	-	yes	yes	-	Option
Retentive memory	-	128 kByte	128 kByte	-	Option
EEPROM	32 kB				

C6 COMPACT 3	Model 1	Model 2	Model 3	Model 4 INTERBUS	Optional variants
Program memory	32 MB (CODESYS V3)				
Data storage	128 MB (CODESYS V3)				
Material number	00C6BE1-1 001	00C6BE1-1 002	00C6BE1-1 004	00C6BE1-2 001	upon re- quest

### 3.2.1 Fieldbus interfaces

#### **X1 socket RJ45**

- EtherCAT master 100 Mbit/s

#### **X2 socket RJ45**

- Ethernet TCP/IP for diagnostics, configuration, update, HMI server and IIOT, 10/100 Mbit/s

#### **X3 socket RJ45 (variant-dependent)**

- Ethernet TCP/IP for diagnostics, configuration, update, HMI server and IIOT, 10/100/1000 Mbit/s

#### **X10 socket D-Sub DE9 (variant-dependent)**

- INTERBUS-IN

#### **X11 socket D-Sub DE9 (variant-dependent)**

- INTERBUS-OUT

#### **X6 terminal block Push-in terminals (variant-dependent)**

- Power Supply; no fieldbus (4 pole)
- Power Supply + CAN (8 pole)
- Power Supply + CAN + RS485 (12 pole)
- Power Supply + CAN + RS232 (16 pole)

### 3.2.2 Ethernet protocols

- DHCP
- DNS
- NTP
- FTP
- FTPS
- SNMP
- HTTP
- HTTPS
- SSH

### 3.2.3 Programming and visualisation

**Programming environment**

- CODESYS V3
- COMBIVIS studio 6

**Programming languages** in accordance with IEC 61131-3.

- Ladder diagram (LD)
- Function block diagram (FBD)
- Continuous func
- Structured text (ST)
- Sequential function cha

**NOA Core**

- System Manager (Web-Based)
- App Manager
- Licence Manager
- System Manager
- Message Bus
- NOA Cloud Connector

**Visualisation**

- HELIO - HMI (Human-Machine Interface) Management System for industrial applications

### 3.2.4 Flash memory

The internal memory of the C6 COMPACT 3 is based on an eMMC.

With frequent write access, you can also use an external memory to extend the lifetime of the read-only memory.

Make regular backups so that you can access your data in the event of an error.



### 3.3 Product identification

#### 3.3.1 Type code

##### 3.3.1.1 Type code

1st and 2nd place	<b>Size or design</b>
00	Standard
3. and 4. digit	<b>Series</b>
C6	Industry automation
5th position	<b>Product type</b>
B	Control
6th position	<b>Control type</b>
E	COMPACT 3
7th position	<b>Configuration</b>
1	Standard
A-Z	Customer version
7th position	<b>Configuration</b>
1	Base device
2	Base device plus expansion card
9./10./11. position	<b>Variant</b>
000	Maximum design
001 ... xxx	See configurable material

#### 3.4 Intended use

The device is intended for use as an industrial control for processes and machines in a typical industrial environment. The instructions for assembly and installation and compliance with the specified limit values for storage, transport and operation must be observed.

When used as intended, the product does not pose any foreseeable hazards.

#### 3.5 Unintended use

Operating the devices outside the limits specified in the technical data, as well as using them in explosion-endangered areas or in an environment with aggressive corrosive gases, will result in the loss of any claims for damages and the specified approvals/acceptances.

### 3.6 Description of the device

#### 3.6.1 Front view

##### 3.6.1.1 Model 1 and 3

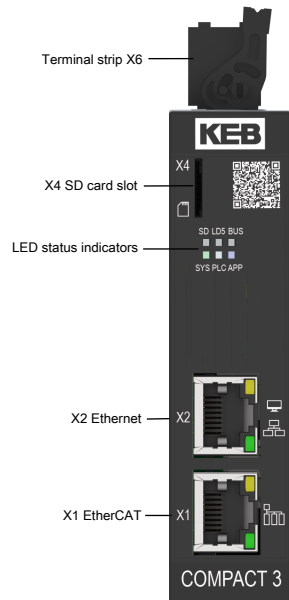

Fig. 1: C6 COMPACT 3 front view of models 1 and 3

##### 3.6.1.2 Model 2

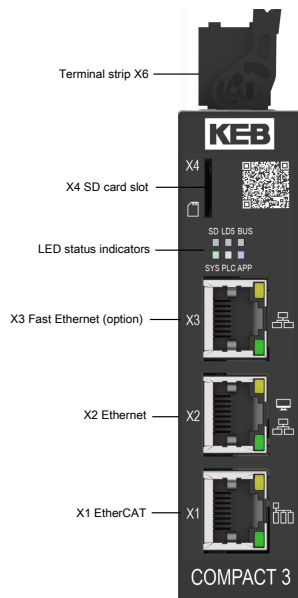

Fig. 2: C6 COMPACT 3 front view model 2

### 3.6.1.3 Model 4

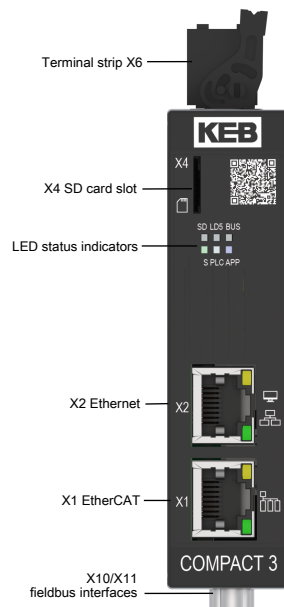

Fig. 3: C6 COMPACT 3 front view model 4

## 3.6.2 Top view

The displayed view shows the COMPACT 3 with 4-pole connector. Depending on the ordered variant, an 8/12 or 16-pole connector may be installed here.

### 3.6.2.1 Model 1 and 2

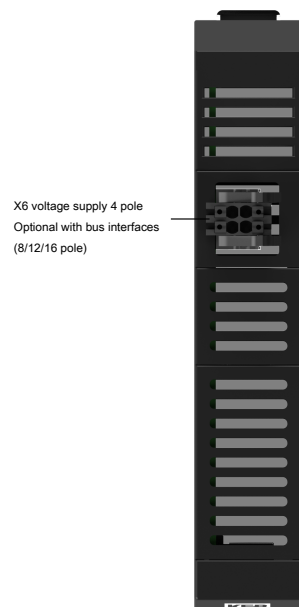

Fig. 4: C6 COMPACT 3 top Model 1 and 2

## 3.6.2.2 Model 3

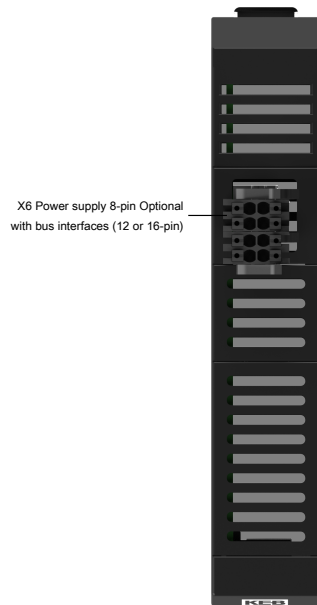

Fig. 5: C6 COMPACT 3 top Model 3

## 3.6.2.3 Model 4

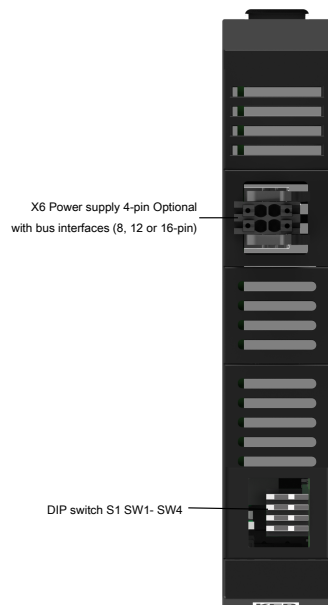

Fig. 6: C6 COMPACT 3 top Model 4

## 3.6.3 View from below

The variant shown here is the INTERBUS version. No interfaces are installed here for all other variants.

3.6.3.1 Model 1, 2 and 3



Fig. 7: C6 COMPACT 3 bottom Model 1, 2 and 3

3.6.3.2 Model 4

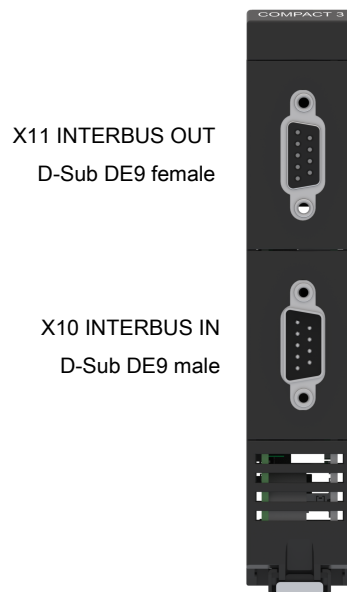

Fig. 8: C6 COMPACT 3 bottom Model 4

## 3.6.4 Rear view all models

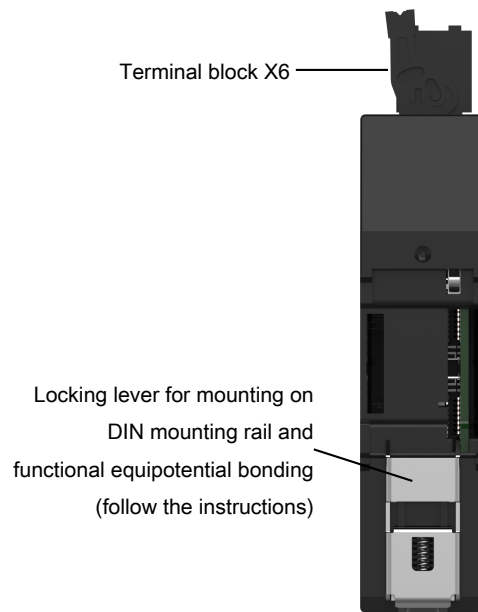

Fig. 9: C6 COMPACT 3 rear view

### 3.6.5 Nameplate

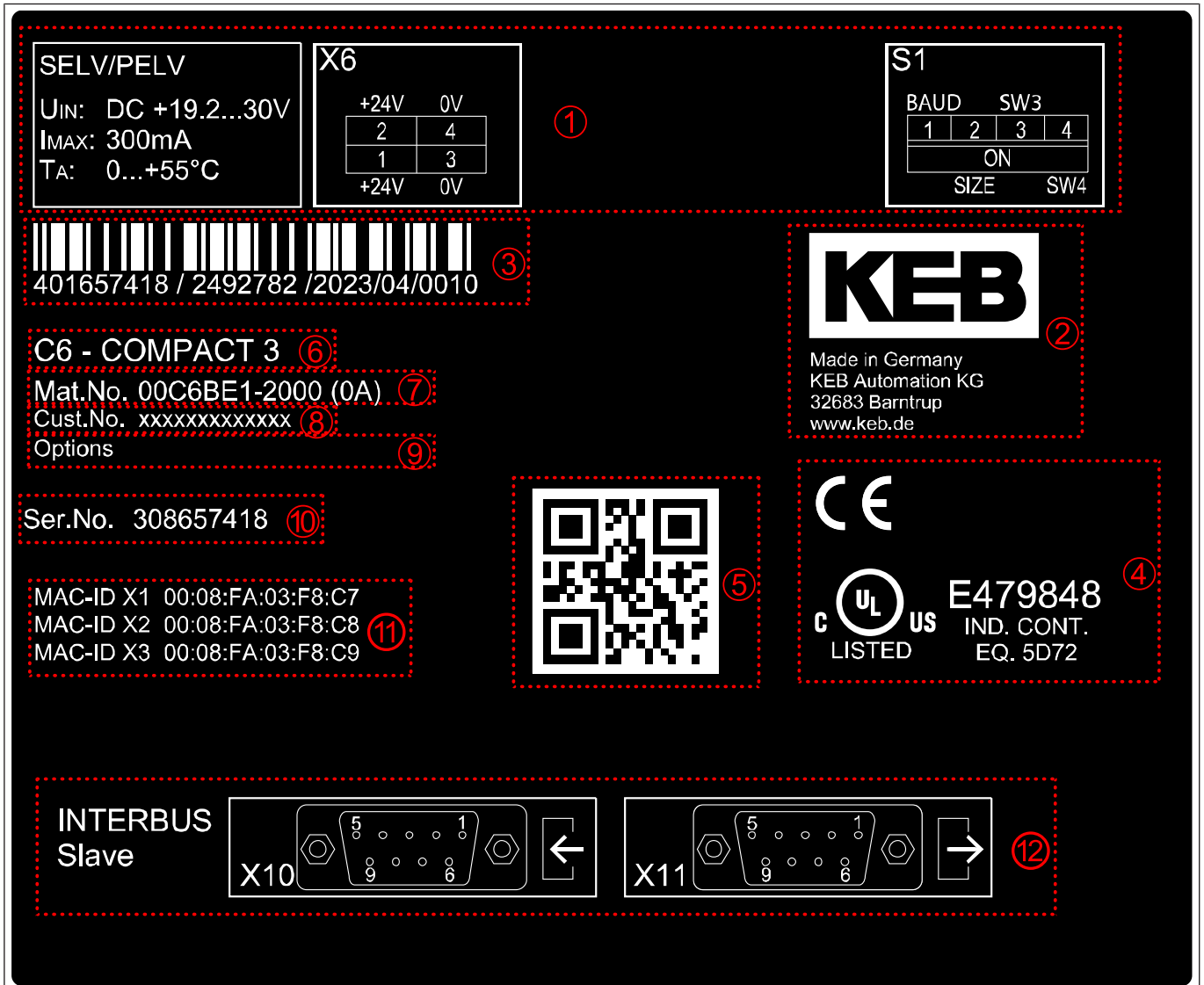

Fig. 10: Nameplate

① Description of the connection elements	② Manufacturer details
③ Barcode with serial number, order number, year/week of manufacture, plant	④ Certifications
⑤ Barcode for device identification	⑥ Device designation
⑦ Material / basic device number, revision	⑧ Customer device number
⑨ Configured options of the device	⑩ Serial number
⑪ MAC-Ids (variant-dependent)	⑫ Description of optional hardware

## 4 Technical data

### 4.1 Operating conditions

#### 4.1.1 Climatic ambient conditions

Storage	NORM	Value	Notes
Ambient temperature	-	-40...70 °C	
Relative humidity	-	5...85 %	Without condensation
Transport	Norm	Value	Notes
Ambient temperature	-	-40...70 °C	
Relative humidity	-	5...85 %	Without condensation
Operation	Norm	Value	Notes
Ambient temperature	-	-20...55 °C	
Relative humidity	-	5...85 %	Without condensation
Degree of protection	EN 60529	IP20	Only suitable for indoor use
Site altitude	EN 61010-1	3000 m	From 2000 m above NHN, the ambient temperature during operation must be reduced by 0.5°C per 100 m.

#### 4.1.2 Mechanical ambient conditions

Operation	Norm	Class	Notes
Vibration limits	IEC 60068-2-6	5...9 Hz	7 mm p-p (all 3 axes)
		9...150 Hz	1 g (all 3 axes)
Shock limit values	IEC 60068-2-27	±15 g 11 ms	3 pulses per axis and direction

#### 4.1.3 Electrical operating conditions

##### 4.1.3.1 Device classification

Requirement	Norm	Value	Notes
Overvoltage category	IEC 61010-1	Cat. II	-
Pollution degree	EN 61010-1	2	May require installation of the control in a housing with appropriate degree of protection, e.g. IPx4
Protection class	IEC 61010-2	III	-



## 4.2 Electrical data

C6 COMPACT 3	Notes
Rated input voltage	DC 24 V SELV/PELV protected against polarity reversal
Input voltage range	DC 19,2 V bis 30 V (IEC 61131-2 and better)
Rated input current	300 mA
Power input	7.2 W
Internal fusing	1 A
Overvoltage protection	internal
Protection against transient overvoltages	internal
Potential separation 24 V to functional earth	DC 707 V
Potential separation 24 V to communication interfaces	DC 1200 V
Basic insulation between 0 V and functional earth	32 V
Real-time clock (RTC)	Charging time (2 h when fully discharged) Buffer time up to 30 days

## 5 Assembly

### 5.1 Assembly instructions

To prevent damage to the product, observe the following instructions:

- Make sure that no components are bent and/or isolation distances are changed.
- The product must not be put into operation in case of mechanical defects. Non-compliance with the applicable standards.
- Do not allow moisture, mist or toxic gas to penetrate the product.
- Avoid dust permeating the device. Allow for sufficient heat dissipation if installed in a dust-proof housing.
- Observe minimum installation distances to surrounding elements.
- Do not cover the ventilation openings.
- Install the product in accordance with the required degree of protection (e.g. control cabinet).
- Make sure that no small parts fall into the product during assembly and wiring (drilling chips, screws etc.). This also applies to mechanical components, which can lose small parts during operation.
- Secure the connection cable against mechanical influences (tension, vibrations).

## 5.2 Dimensions

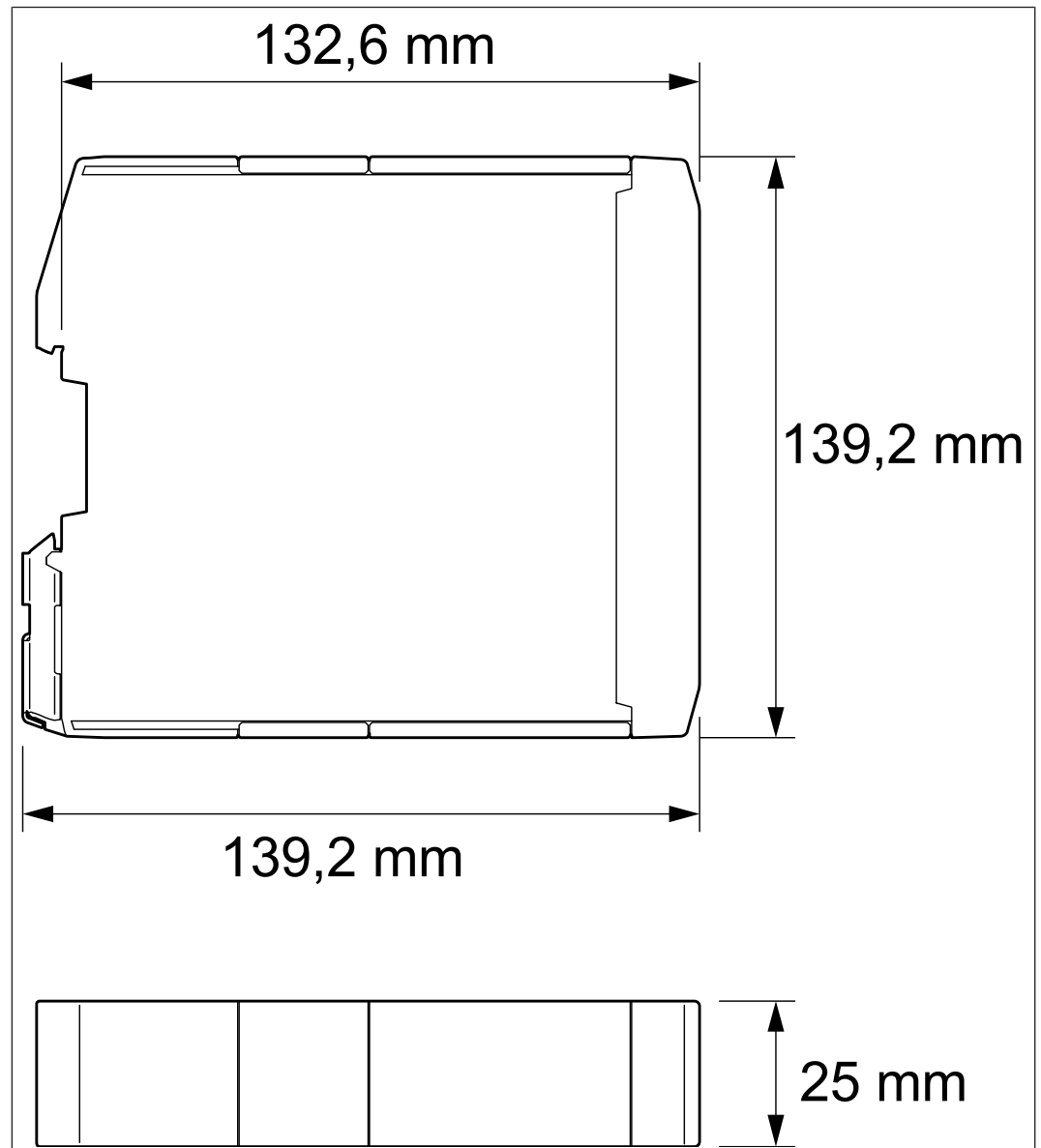

Fig. 11: Dimensions COMPACT 3

## 5.3 Mounting direction

The following mounting orientations are possible without derating:

- typical for control cabinets (mounting rail horizontally on the wall).

## 5.4 Minimum installation distances

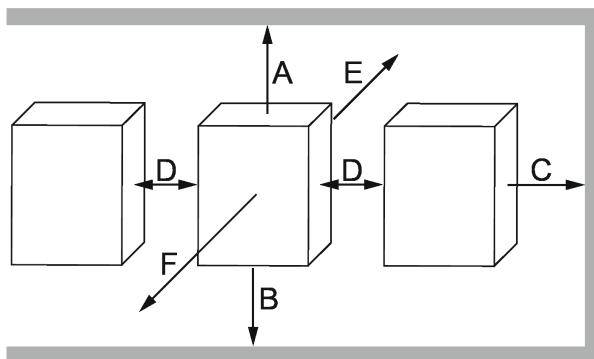

Fig. 12: Installation distances

Dimension	Distance	
A	100 mm	4 inch
B	100 mm	4 inch
C	0 mm	0 inch
D	0 mm	0 inch
E	0 mm	0 inch
F <sup>1)</sup>	50 mm	2 inch
1) Distance to upstream control elements in the control cabinet door.		

## 5.5 Mounting of the control

The control is designed for mounting on a mounting rail. The mounting rail is part of the EMC concept and is therefore **mandatory**. Requirements on the mounting rail:

- The mounting rail must be made of conductive metal.
- Permissible types are TH35/7,5 and TH35/15 in accordance with EN 60715.
- The mounting rail serves as functional earth and must be mounted on a metallic, earthed place (e.g. rear wall of the control cabinet). If this is not possible, the mounting rail must be connected to the functional equipotential bonding via separate connection. The conductor should have a cross section of at least 4 mm<sup>2</sup>.
- To prevent vibration problems, the mounting rail should be connected to the mounting bracket maximally every 200 mm.
- Ensure that there is no heat build-up in a multi-level structure.

### 5.5.1 Mounting on a mounting rail

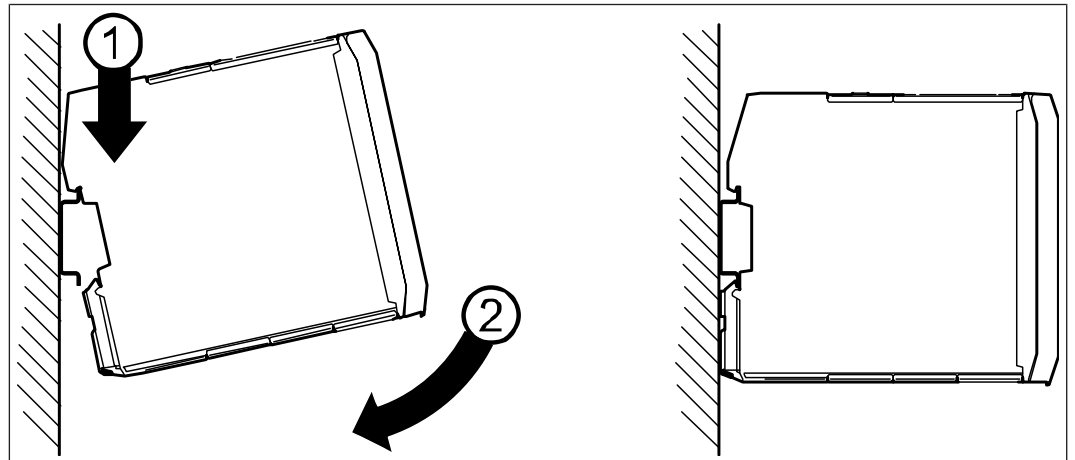

Fig. 13: Mounting on a mounting rail

- 1 Hook the housing groove from above onto the mounting rail.
- 2 Press the housing towards the mounting surface until the latch engages. Then check for tightness.

### 5.5.2 Disassembly of the mounting rail

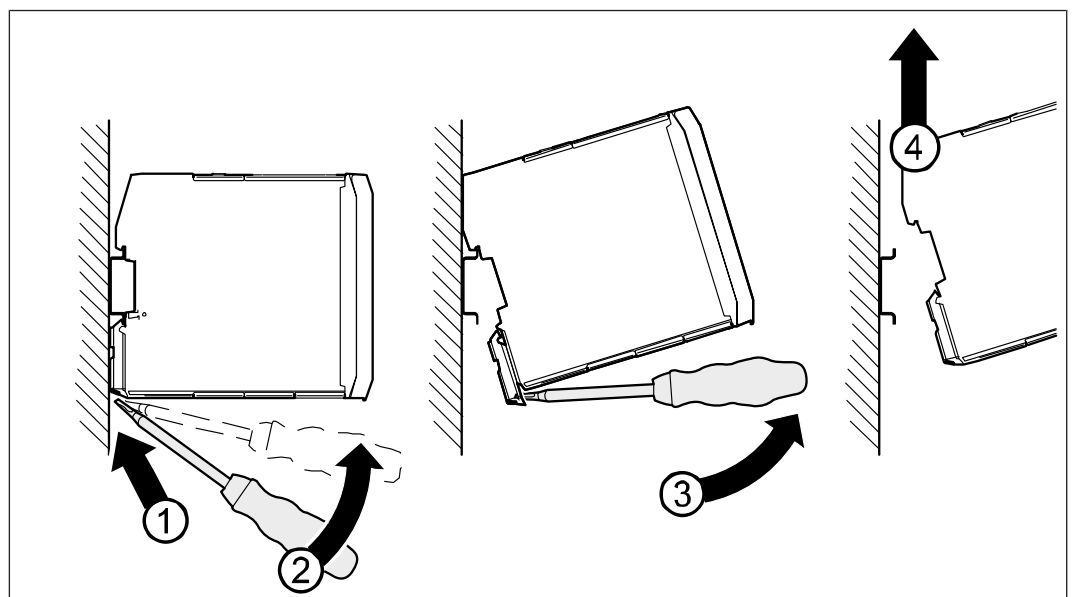

Fig. 14: Disassembly of the mounting rail

- 1 Insert screwdriver into the locking device.
- 2 Tilt the screwdriver towards the housing to release the locking device.
- 3 Tilt the device up with the released locking device.
- 4 Carefully lift the device upwards.

## 6 Electrical installation

### NOTICE



#### Ensure line protection by triggering the fuse!

- a) The supply voltage must be able to supply fourfold of the rated current of the internal fuse (4 A).
- b) If a smaller power supply is used depending on the application, the device must be protected with an external fuse.

- Lay control and power cables separately (approx. 10...20 cm distance).
- Lay power cable crossings at right angles.
- The following measures can be taken to prevent electromagnetic interferences:
  - Always connect the shielding with the greatest possible surface.
  - Position the shield as close as possible to the terminal.
  - Always use twisted and shielded cables for analog control cables. Connect shielding to source on one side only.
  - Twist digital control cables. Shielding may be required from 3 m. In this case, place on both sides.
- The device is protected against reverse polarity of the input voltage.
- The 24 V supply must not fall below or exceed the input voltage range specified in the technical data, independent of the operating conditions.
- If power interruptions need to be bridged, an external UPS must be used.

### 6.1 Assembly of wires

### NOTICE

#### Loose and slack cable connections!

#### Malfunctions due to loose contacts.

- a) Observe metal sleeve length and stripping length according to table.
- b) Use a suitable pressing tool.
- c) Make sure that all wires are inserted into the wire-end sleeve.
- d) After inserting the cable into the terminal, check that it is firmly seated.

Cross section	Wire end ferrule	Metal sleeve length	Stripping length
0.5...1 mm <sup>2</sup> (20...17 AWG)	With plastic collars	10 mm	12 mm
0.5...1,5 mm <sup>2</sup> (20...16 AWG)	Without plastic collars	10 mm	10 mm
0.2...1.5 mm <sup>2</sup> (24...16 AWG) Solid or fine strand	Without wire end ferrule	-	10 mm

Tab. 1: Wire end ferrules and stripping length

## 6.2 Voltage supply

### NOTICE



#### Use of suitable voltage sources!

#### Electric Shock!

- Only voltage sources with safe extra-low voltage in accordance with HD 60364-4-41 may be used.
- Ensure that the used voltage supplies have the appropriate overvoltage category for the application.
- The requirements listed for SELV and PELV circuits in HD 60364-4-41 must be complied with.
- With existing or newly-wired circuits the person installing the device or machine must ensure that the PELV requirements are met.
- Connections with higher voltages must be excluded.

### 6.2.1 Terminal block X6

Voltage supply occurs via terminal block X6. Depending on the variant, a 4-, 8-, 12- or 16-pole pluggable terminal block is used.

X6	PIN	Designation	Notes
	1	24V	DC 24 V supply voltage (internally connected to pin 3)
	2	0V	Reference potential to 24 V (internally connected to pin 4)
	3	24V	DC 24 V supply voltage (internally connected to pin 1)
	4	0V	Reference potential zu 24 V (internally connected to pin 2)
	5-8	-	(⇒ <a href="#">CAN</a> [▶ 35])
	9-12	-	(⇒ <a href="#">RS485</a> [▶ 37])
	13-16	-	(⇒ <a href="#">RS232</a> [▶ 38])

X6	PIN	Designation	Notes

Tab. 2: Assignment of terminal block X6

The terminals for the voltage supply are always identical, independent of the above design.

#### Notes

The connection terminals X6.1/X6.3 and X6.2/X6.4 are connected internally to create a daisy chain if required.

The 0 V terminals are **not** internally connected to earth.

The maximum permissible current via the terminal is 9.5 A and must not be exceeded.

The cables must be designed according to the current.

### 6.3 Earthing

A connection to the protective earth conductor is not required, because the device is operated with ELV (SELV/PELV)..

### 6.4 Equipotential bonding

The C6 Compact is designed to discharge EMC interference via the mounting rail.

This must therefore be connected to the functional equipotential bonding (can also be the

equipotential bonding). The following points must be observed:

- Good, large-surface connection from the mounting rail to the support (if it is conductive)
- Low-impedance connection of the support for potential equalisation (e.g. min. 4 mm<sup>2</sup> cable or ribbon cable)

Information on equipotential bonding conductors can be found at HD 60364-5-54!



## 6.5 EtherCAT Master X1

Specification	Fieldbus type	EtherCAT®
	Socket	X1 RJ45
	Transmission level	100Base-Tx according to IEEE802.3 with autonegotiation and auto-crossover
	Transmission speed	100 Mbit/s
	Transmission medium	Twisted Pair S-UTP; Cat. 5 maximum cable length 100 m
	Potential separation	Functional isolation to the control potential.

### Connection

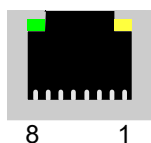

Fig. 15: RJ45 socket front view

PIN	RJ45 without supply voltage (Viewing with Auto-Cross Over)	
1	TX+	RX+
2	TX-	RX-
3	RX+	TX+
4	Reserved	
5	Reserved	
6	RX-	TX-
7	GND	
8	GND	

Tab. 3: PIN assignment RJ45 EtherCAT

LED / light pattern	Function
<b>Yellow</b>	<b>without function</b>
<b>Green</b>	<b>Link/Activity</b>
Off	Port closed
On	Port open; no data traffic
Flicker	Port open; with data traffic

Tab. 4: Function of the LEDs

## 6.6 Ethernet X2

Specification	Fieldbus type	Ethernet
	Socket	X2 RJ45
	Transmission level	100Base-Tx according to IEEE802.3 with autonegotiation and auto-crossover
	Transmission speed	10/100 Mbit/s
	Transmission medium	Twisted Pair S-UTP; Cat. 5 maximum cable length 100 m
	Potential separation	Functional isolation to the control potential.

### Connection

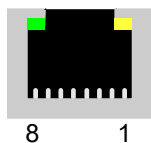

Fig. 16: RJ45 socket front view

PIN	RJ45 without supply voltage (Viewing with Auto-Cross Over)	
1	TX+	RX+
2	TX-	RX-
3	RX+	TX+
4	reserved	
5	reserved	

PIN	RJ45 without supply voltage (Viewing with Auto-Cross Over)	
6	RX-	TX-
7	GND	
8	GND	

Tab. 5: PIN assignment RJ45 Ethernet

LED / light pattern	Function
Yellow (flashing)	Port available
Green	Link/Activity
Off	Port closed or not connected
On	Port opened; no data traffic
Flickering	Port opened; with data traffic

Tab. 6: Function of the LEDs

## 6.7 Ethernet X3

### Specification

Fieldbus type	Ethernet
Socket	X3 RJ45
Transmission level	1000Base-Tx according to IEEE802.3 with autonegotiation and auto-crossover
Transmission speed	10/100/1000 Mbit/s
Transmission medium	Twisted Pair S-UTP; Cat. 6 maximum cable length 100 m
Potential separation	Functional isolation to the control potential.

### Connection

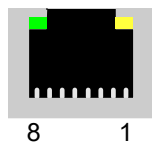

Fig. 17: RJ45 socket front view

PIN	RJ45 without supply voltage (Viewing with Auto-Cross Over)	
1	TX+	RX+
2	TX-	RX-
3	RX+	TX+
4	reserved	
5	reserved	
6	RX-	TX-
7	GND	
8	GND	

Tab. 7: PIN assignment RJ45 Ethernet

LED / light pattern	Function
Yellow (flashing)	Port available
Green	Link/Activity
Off	Port closed or not connected
On	Port opened; no data traffic
Flickering	Port opened; with data traffic

Tab. 8: Function of the LEDs

## 6.8 CAN

The CAN bus is connected via terminal block X6. Depending on the variant, an 8, 12 or 16-pole plug-in terminal block is used.

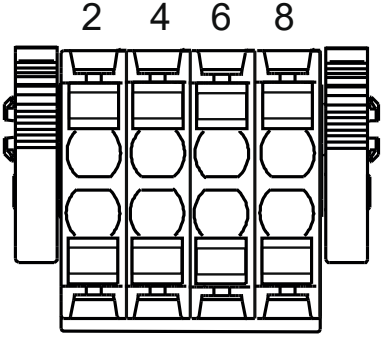
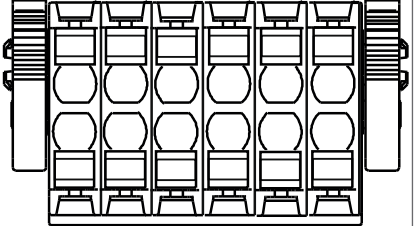
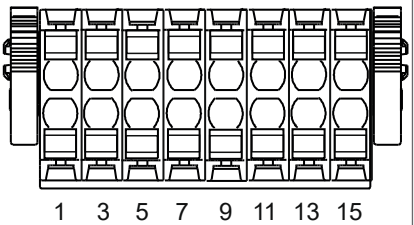
X6	PIN	Designation	Notes	
	1-4	-	Voltage supply	
	5	Shielding	Shield connection (FE)	
	6	CAN_GND	Reference potential CAN (galvanically isolated)	
	7	CAN_H	CAN data signal high	
	8	CAN_L	CAN data signal Low	
	9-12	-	(⇒ <a href="#">RS485</a> [ <a href="#">37</a> ])	
		13-16	-	(⇒ <a href="#">RS232</a> [ <a href="#">38</a> ])
				

Tab. 9: Assignment of terminal block X6

The terminals for the CAN bus are always identical, independent of the above design.

### Specification

Fieldbus type	CAN
Transmission level	In accordance with DIN ISO 11898; ISO High Speed
Transmission speed	20, 25, 50, 100, 125, 250, 500, 800, 1000 kbit/s; adjustable via CN01
Transmission medium	Twisted pair maximum cable length 40 m
Potential separation	Functional isolation between CAN terminals and control potential.
Bus termination	120 Ω external between (CAN High and CAN Low) at both ends of the bus cable.

## Connection

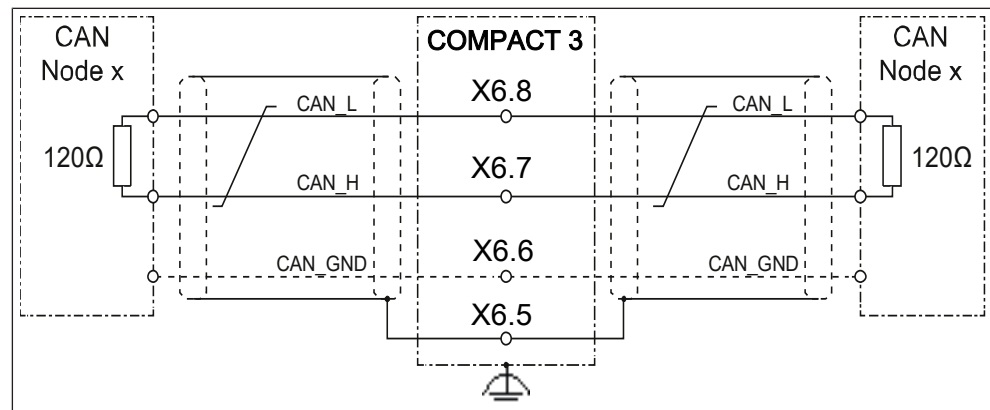

Fig. 18: Connection CAN bus

Terminal X6	Designation	Note
5	Shielding	Total shield
6	CAN GND	CAN ground (can be wired depending on the customer participant)
7	CAN High	Data cable CAN_H and CAN_L twisted;
8	CAN Low	no internal bus termination

## LD5 - LED in CAN mode

The LD5 - LED is a combination of a RUN and ERROR LED according to CiA 303-3.

The LD5 LED indicates the status of the primary fieldbus used for control.

## Light pattern LD5 LED (red/green combination)

Status	Light pattern	Description
Pre-Op	g-0 (grid 200 ms)	Device in PRE-OPERATIONAL status
Stop	g-0-0-0-0-0 (grid 200 ms)	Device in STOPPED status
Op	g (permanent)	Device in OPERATIONAL status; no error
Bus off	r (permanent)	CAN bus switched off.
Invalid Configuration	r-0 (grid 200 ms)	General configuration error.
Warning limit reached	r-0-0-0-0-0 (grid 200 ms)	An error counter has reached or exceeded the warning level.
Legend	r: Red g: Green 0: off	The red/green signals are shifted by 180°. Red has priority in the event of overlapping.

## see also

Terminal block X6 [► 31]

## 6.9 RS485

The RS485 interface is connected via the X6 terminal block. Depending on the variant, a 12- or 16-pole pluggable terminal block is used.

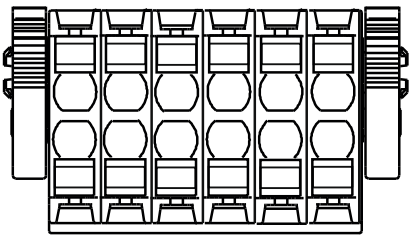
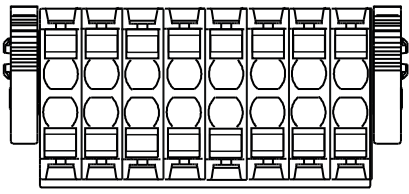
X6	PIN	Designation	Notes
	1-4	-	(⇒ <a href="#">Voltage supply</a> [ <a href="#">▶ 31</a> ])
	5-8	-	(⇒ <a href="#">CAN</a> [ <a href="#">▶ 35</a> ])
	9	VCC+5V	Termination potential for RS485
	10	GND_RS	Reference potential for serial interfaces (galvanically isolated)
	11	RxD/TxD-P	RS485 data signal
	12	RxD/TxD-N	RS485 data signal inverted
	13-16	-	(⇒ <a href="#">RS232</a> [ <a href="#">▶ 38</a> ]) interface

Tab. 10: Assignment of terminal block X6

The terminals for the RS485 interface are always identical, independent of the above design.

### Specification

Fieldbus type	RS485 2W
Common-ode voltage range	0... 12 V to the reference potential.
Transmission speed	20, 25, 50, 100, 125, 250 kbit/s; adjustable via CN01
Transmission medium	Twisted pair maximum cable length 1200 m depending on the transmission speed
Potential separation	Functional insulation between terminals and device potential.
Bus termination	120 Ω external (between RxD/TxD-P and RxD/TxD-N) at both ends of the bus cable.

## 6.10 RS232

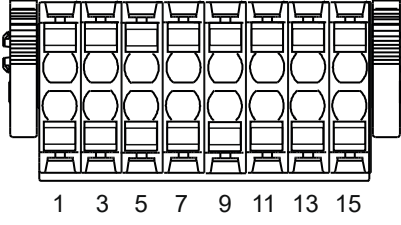
X6	PIN	Designation	Notes
	1-4	-	Voltage supply
	5-8	-	(⇒ <a href="#">CAN</a> [ <a href="#">▶ 35</a> ])
	9, 11, 12	-	RS485
	10	GND_RS	Reference potential for serial interfaces (galvanically isolated)
	13	RxD	RS232 receive signal
	14	TxD	RS232 transmission signal
	15	CTS	Ready to receive (clear to send)
	16	RTS	Ready to send (request to send)

Tab. 11: Assignment of terminal block X6

## 6.11 INTERBUS interface X10, X11

Optionally, the C6 COMPACT 3 can be ordered with an INTERBUS slave interface. The word and size parameters are configured via DIP switch S1.

Input:

D-SUB DE-9 (socket)

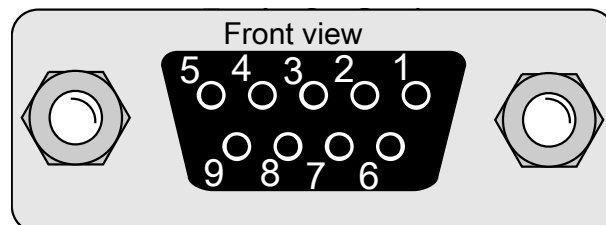

Fig. 19: X10 INTERBUS input

1 DO	2 DI
3 COM	4 -
5 -	6 /DO
7 /DI	8 -
9 -	

Output  
D-SUB DE-9 (connector)

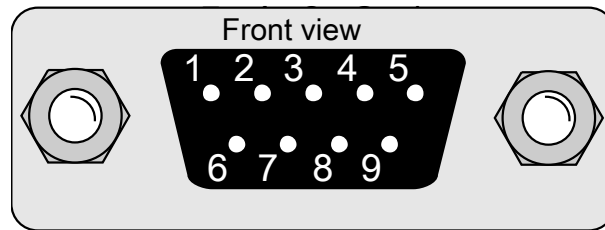

Fig. 20: X11 INTERBUS output

1 DO	2 DI
3 COM	4 -
5 -	6 /DO
7 /DI	8 -
9 -	

### 6.11.1 INTERBUS DIP switch S1

	<p><b>SW1 Baud</b> off: on:</p> <p><b>SW2 size</b> off: on:</p> <p><b>SW3, SW4</b> reserved</p>
--	---

Tab. 12: DIP switch 4-fold

### 6.11.2 INTERBUS remote bus cable

Specification

Number of conductors	3x 2-pair (twisted) with overall shielding
Conductor cross-section	min. 0.2 mm <sup>2</sup>
Conductor resistance per 100 m	max. 9,6 Ω

Tab. 13: Specification INTERBUS remote bus cable

Refer to the cable manufacturer's data sheet for further specifications.

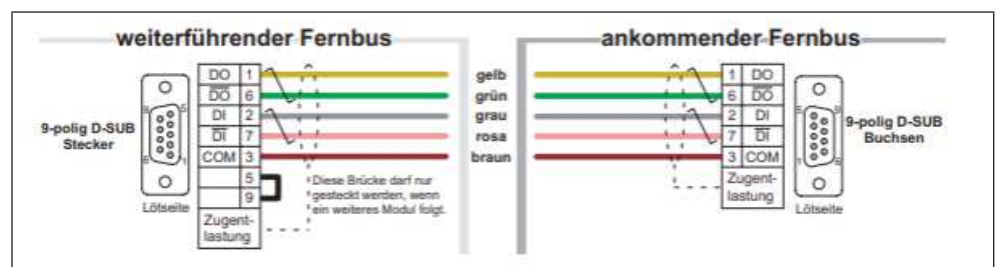

Fig. 21: INTERBUS remote bus cable assignment

## 7 Operation

### 7.1 Status displays

A total of 6 LEDs are available to display the status.

The following LEDs show the system status:

**SYS** for general system statuses of the device

**PLC** for error signalling

**APP** for the CodeSys application (RUN / STOP / ...)

**SD** for access to the  $\mu$ SD (can be changed for free disposal)

2 (3) LEDs are available for function extensions (fieldbus-specific)

**LD5** for Interbus slave or other fieldbuses

**BUS** for EtherCAT master or freely available

**SD** freely available if  $\mu$ SD signalling is not required

Flashing pattern of the LEDs

SYS LED flashing pattern during boot process

Colour/ flashing pattern	Type	Code	Message	Description
red / static	Info	-	-	Supply voltage is present. Kernel not yet booted.
red / static	Error	E-SYS4	Boot error	Kernel could not be started within 10 s.
yellow / flashing	Info	I-SYS4	System start	System is booted.
off	-	-	-	No voltage supply

Tab. 14: SYS LED flashing pattern during boot process

Flashing pattern SYS LED in operation

Colour/ flashing pattern	Type	Code	Message	Description
green / static	Info	I-SYS1	System is running	System is running. No error reported.
red / flashing	Error	E-SYS2	Operating system error	System error occurred.
red / yellow flashing	Warning	W-SYS1	System update in progress	Do not switch off the device!
yellow / static	Warning	W-SYS3	System warning	Voltage drop detected in the system.
yellow / static	Warning	W-SYS4	System warning	With error output
yellow / static	Warning	W-SYS2	System warning	With error output, e.g. memory almost full.



Colour/ flashing pattern	Type	Code	Message	Description
green / yellow flashing	Info	I-SYS3	Wink function	The Wink function has been activated in the System Manager. The device can be localised via the flashing LED.

Tab. 15: Flashing pattern SYS LED in operation

Flashing pattern PLC LED

Colour/ flashing pattern	Type	Code	Message	Description
green / static	Info	I-PLC1	CODESYS application is running	The CODESYS application is fully loaded and is running.
red / static	Error	E-PLC1	CODESYS application is stopped	The CODESYS application is not running.

Tab. 16: Flashing pattern PLC LED

Flashing pattern APP LED

Colour/ flashing pattern	Type	Code	Message	Description
green / static	Info	I-APP1	Application is running	App Manager does not report any applications with errors.
yellow / static	Warning	W-APP1	Some applications have been stopped	Check in the App Manager.
red / static	Error	E-APP1	Application error	The App Manager has reported an error.
red / yellow flashing	Info	I-APP2	Applications are updated	The App Manager is busy.

Tab. 17: Flashing pattern APP LED

Flashing pattern SD LED

Colour/ flashing pattern	Type	Code	Message	Description
red / static	Error	E-SD1	SD error	SD card does not work properly.

Tab. 18: Flashing pattern SD LED

Flashing pattern LD5 LED

Colour/ flashing pattern	Type	Code	Message	Description
red / static	Error	E-IBS1	Fieldbus error	Error in the INTERBUS slave.

Tab. 19: Flashing pattern LD5 LED (USER mode)

Flashing pattern BUS LED

Colour/ flashing pattern	Type	Code	Message	Description
red / static	Error	E-BUS1	Fieldbus error	Error on the EtherCAT bus.

Tab. 20: Flashing pattern BUS LED

## 7.2 Start-up

### 7.2.1 Requirements for start-up

To start-up the COMPACT 3, the following minimum requirements apply to the browser:

IDE	HMI	Mobile
Google Chrome from version 106	Google Chrome from version 106	Google Chrome (Android) from version 113
Microsoft Edge from version 106	Microsoft Edge from version 106	Safari (iOS) from version 16
	Safari (macOS) from version 16	

Tab. 21: Browser depending on the device

### 7.2.2 Find COMPACT 3 in the network

If only one COMPACT 3 is available in the same network segment, it can be found using the ping command.

To do this, the following command is typed into the command line interpreter:

```
ping C6C3 -4
```

the following result should appear:

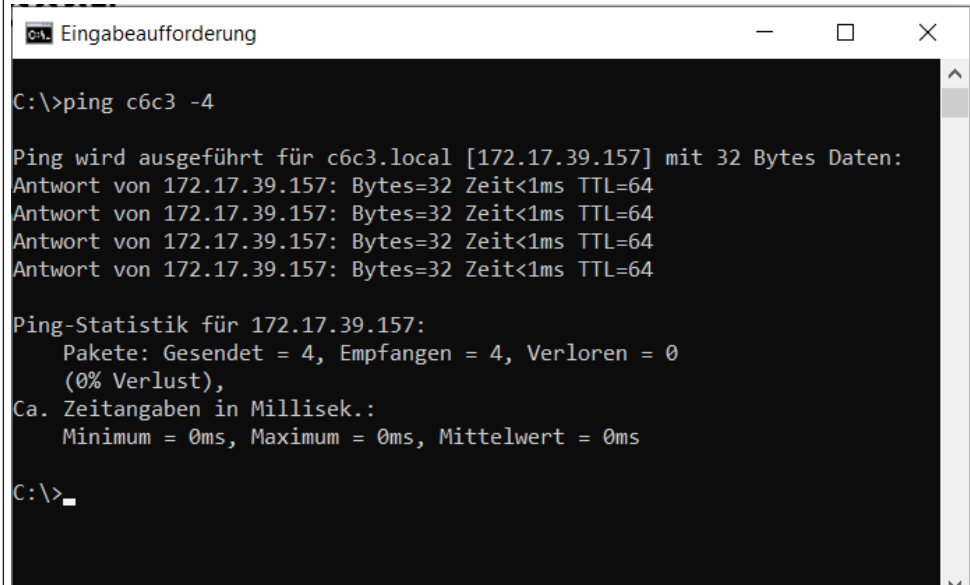

```

C:\>ping c6c3 -4

Ping wird ausgeführt für c6c3.local [172.17.39.157] mit 32 Bytes Daten:
Antwort von 172.17.39.157: Bytes=32 Zeit<1ms TTL=64
Antwort von 172.17.39.157: Bytes=32 Zeit<1ms TTL=64
Antwort von 172.17.39.157: Bytes=32 Zeit<1ms TTL=64
Antwort von 172.17.39.157: Bytes=32 Zeit<1ms TTL=64

Ping-Statistik für 172.17.39.157:
    Pakete: Gesendet = 4, Empfangen = 4, Verloren = 0
            (0% Verlust),
    Ca. Zeitangaben in Millisek.:
        Minimum = 0ms, Maximum = 0ms, Mittelwert = 0ms

C:\>

```

Fig. 22: find IP address

For more convenience or if there are several COMPACT 3 devices in the network, an IP scanner should be used.

Once you have found the device(s), note the corresponding IP address(es).

### 7.2.3 Login

After entering the IP address and port, the login screen appears.

To log in, enter the following user data:

User name: **Service**

Password: **kebadmin**

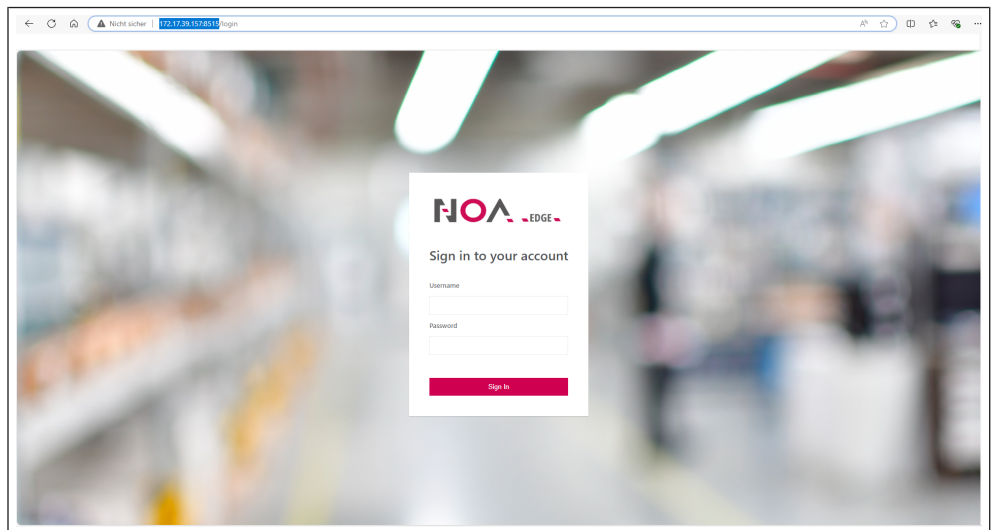

Fig. 23: Login NOA Edge

### 7.2.4 Starting the web interface

The operation is carried out with the web interface NOA UI Hub via the web browser.

The NOA UI Hub is accessed using the IP address of the COMPACT 3 via port 8515.

e.g.: **172.168.2.151:8515**

Then the NOA UI Hub appears with the currently installed apps.

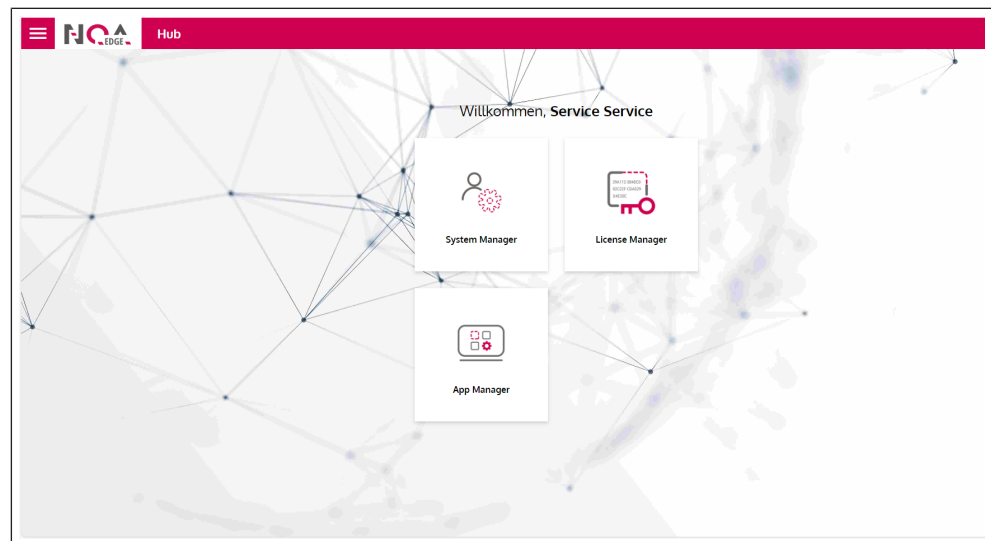

Fig. 24: Starting the NOA UI Hub

Die jeweilige App wird nun mit einem Doppelklick auf die Kachel oder über das Menü links oben aufgerufen.

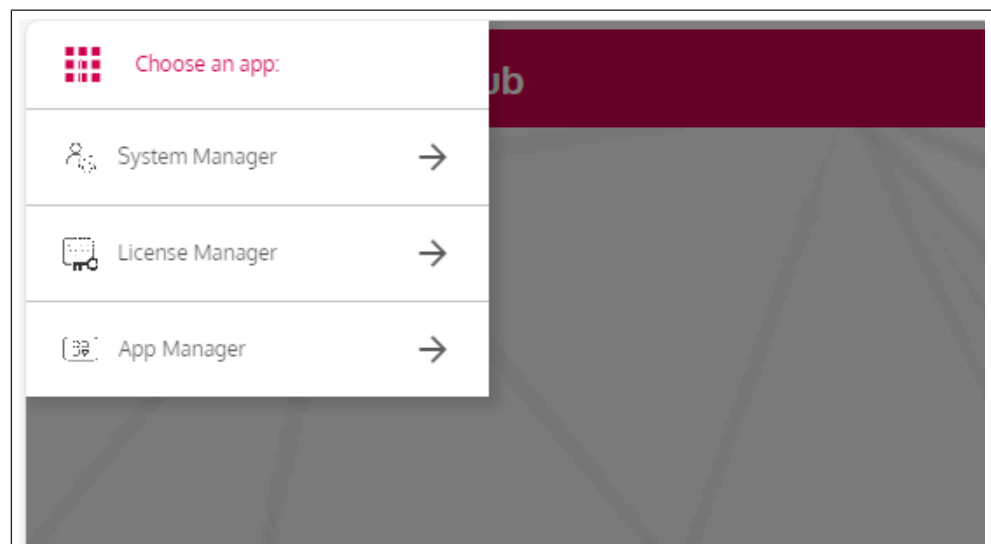
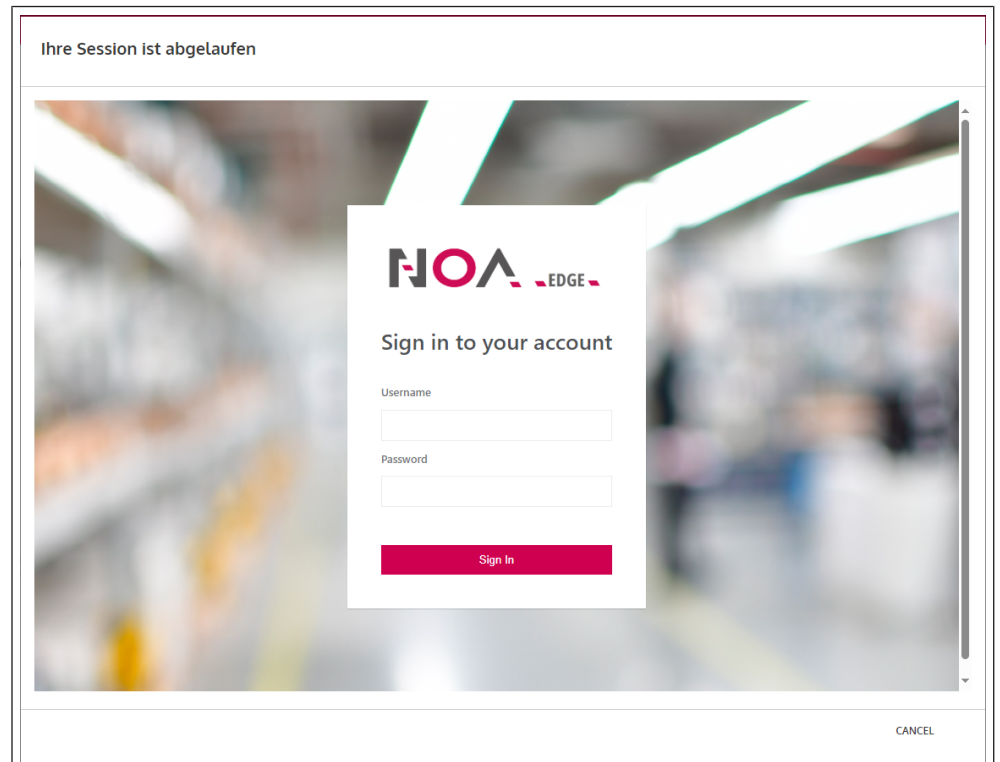

Fig. 25: Select the app and start

## 7.2.5 Logout

If no entries are made for 10 minutes, the user is automatically logged out.



*Fig. 26: Automatic logout*

You can log in again by entering your username and password.

## 7.3 System Manager

### 7.3.1 Overview

The overview shows all information on the selected COMPACT 3. By clicking on the button **Wink**, the status LED "SYS" flashes to identify the selected COMPACT 3 in the control cabinet.

Click on the **Restart** button in the operating system field to restart the COMPACT 3.

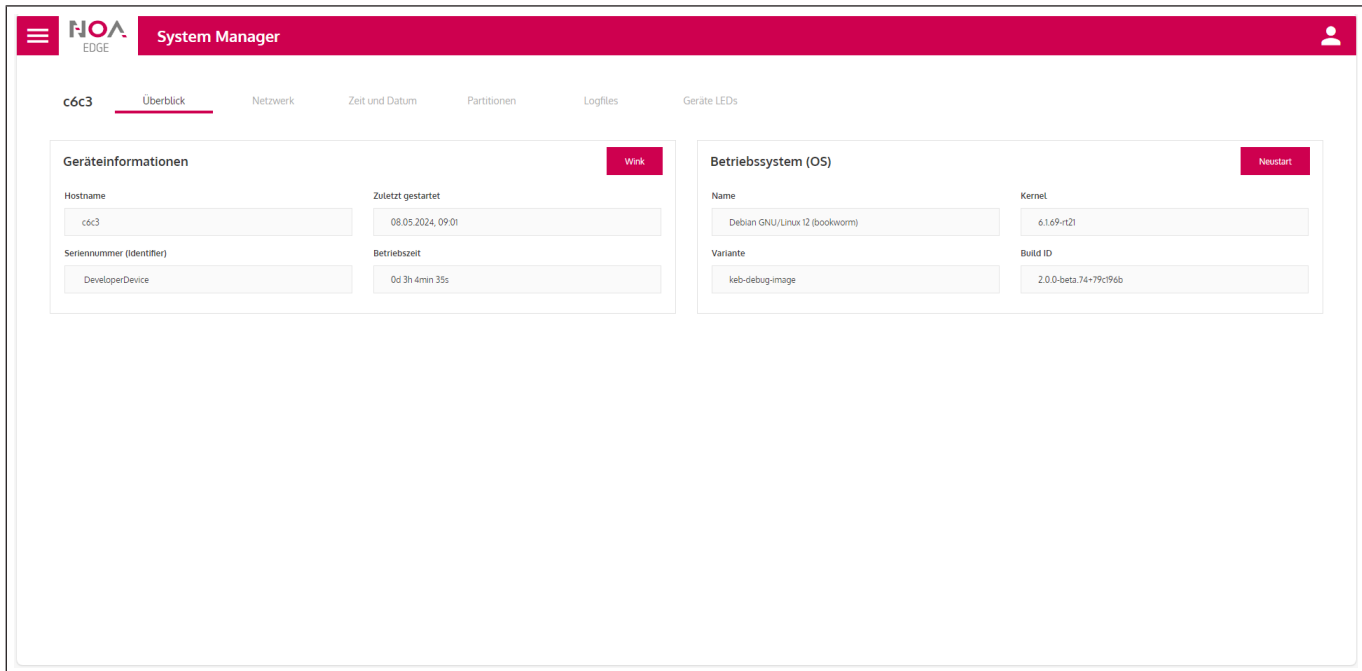

Fig. 27: System Manager overview

### 7.3.2 Network

- Hostname - Name of the control in the network. The pen can be used to change the host name.
- X1, X2, X3 – Settings of the respective interface.
- Manual IP assignment. With this switch, the IP address is no longer assigned automatically via the DHCP server. The settings below can be specified manually.  
Attention! A changed IP address becomes active by clicking **Add** and **Save**. The system manager is now no longer connected to the control. It must be restarted with the new IP address.

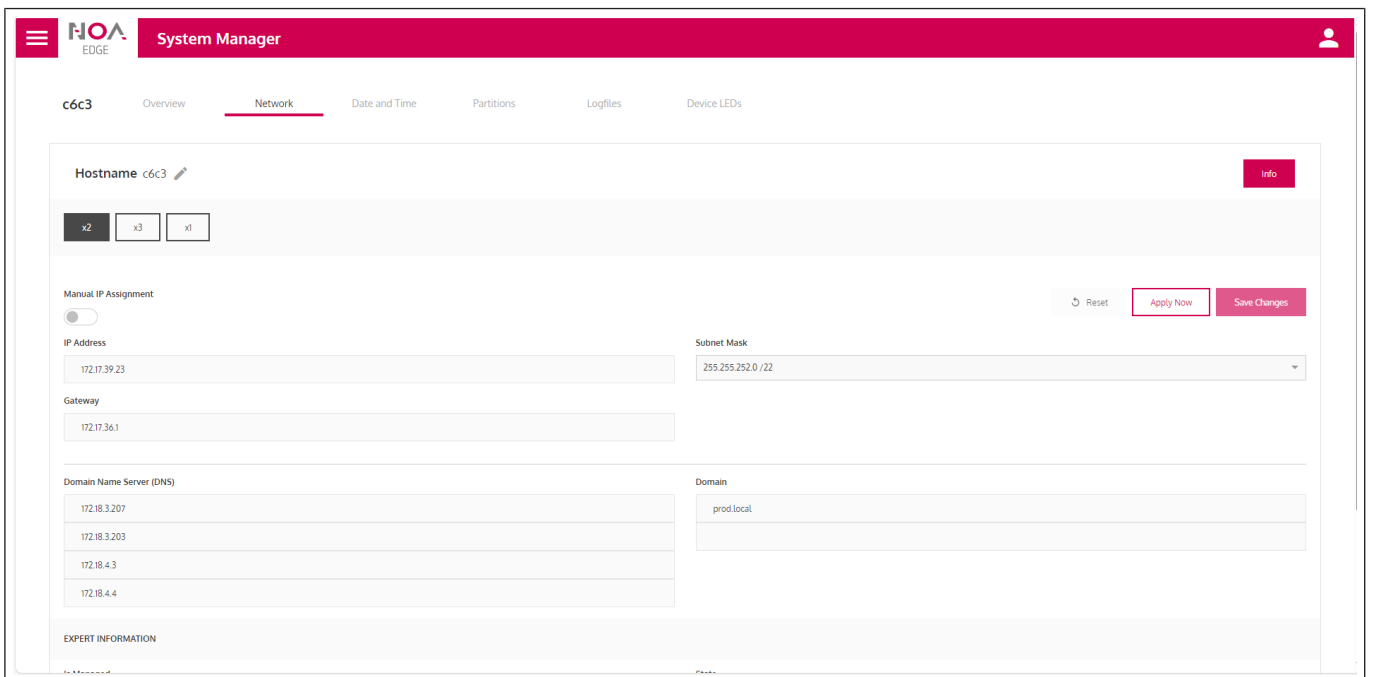

Fig. 28: System Manager - Network

### 7.3.3 Date and time

Switch **Manual date and time**:

- Off - Date and time are obtained automatically via the network.
- On - Date, time and time zone can be set manually.

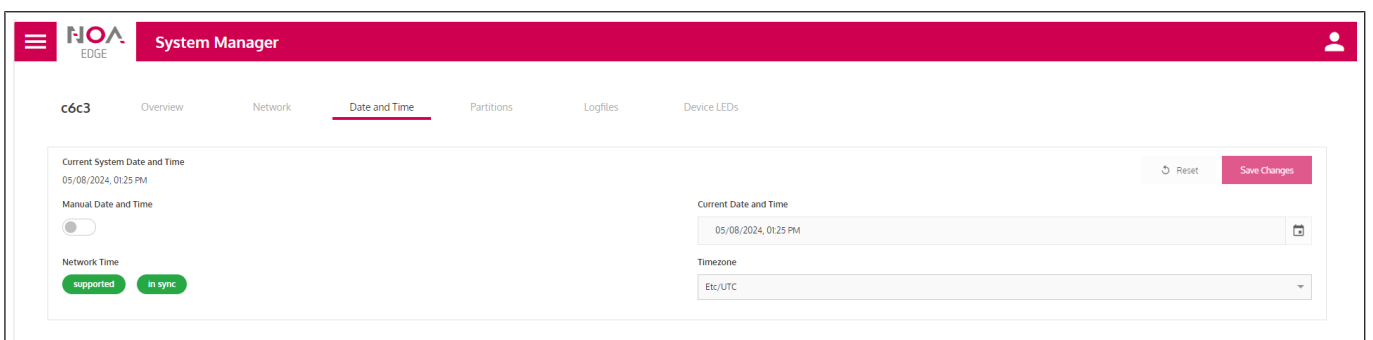

Fig. 29: System Manager date and time

### 7.3.4 Partitions

Display of the partitions created on the COMPACT 3.

Name	Mount Point	Type	Size Total	Size Free	Size Used	Size Used Percent
/dev/mmcblk1p6	/app/sharedData	ext2/ext3	28313595904	27286994944	438329344	1
/dev/mmcblk1p2	/etc/localtime.ro	ext2/ext3	1521885184	667017216	757563392	53
/dev/mmcblk1p5	/var/log	ext2/ext3	61820928	54448128	2678784	4
/dev/mmcblk1p6	/etc/resolv.conf	ext2/ext3	28313595904	27286994944	438329344	1
/dev/mmcblk1p6	/etc/hostname	ext2/ext3	28313595904	27286994944	438329344	1
/dev/mmcblk1p6	/etc/hosts	ext2/ext3	28313595904	27286994944	438329344	1

Fig. 30: System Manager - Partitions

### 7.3.5 Log files

Display of the different log files. Click on for further options regarding the log file.

Name	Change Date	Size	Is Dir
README	2024-01-26T21:48:52.454Z	39	false
auth.log	2024-05-08T08:42:12.34357528Z	29402	false
auth.log.1	2024-05-04T08:37:58.20695826Z	39225	false
btmnp	2024-05-08T08:42:10.861562447Z	2000	false
btmnp.1	2024-01-26T21:48:52.496Z	0	false
chrony	2024-01-26T21:48:57.513Z	4096	false
kern.log	2024-05-08T11:02:51.318927105Z	259656	false
kern.log.1	2024-05-02T13:25:53.569751083Z	337506	false
lastlog	2024-05-06T11:34:25.766621731Z	296296	false
lost+found	2024-04-24T12:08:49Z	16384	false
private	2024-05-06T12:10:05.112266249Z	4096	false
evselm	2024-05-08T11:04:00.045097901Z	761047	false

Fig. 31: System Manager - Log-files



### 7.3.6 Device LEDs

The status of the device LEDs is displayed here, analog to the device. (⇒ [Status displays \[▶ 40\]](#)).

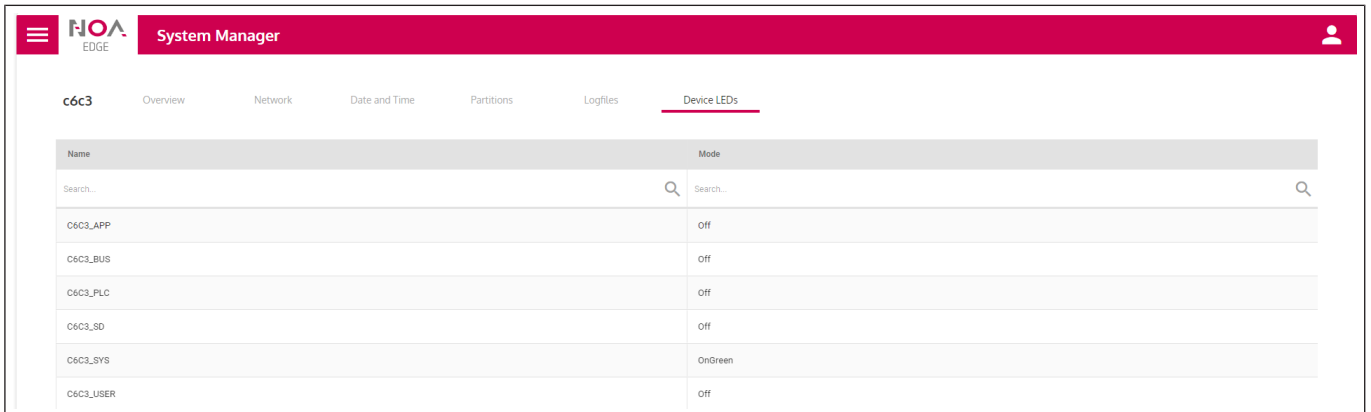

Fig. 32: System Manager - Device LEDs

## 7.4 Licence Manager

### 7.4.1 My licences

The currently installed licenses are displayed here. Additional licenses can be added using the “+ Add License” button.

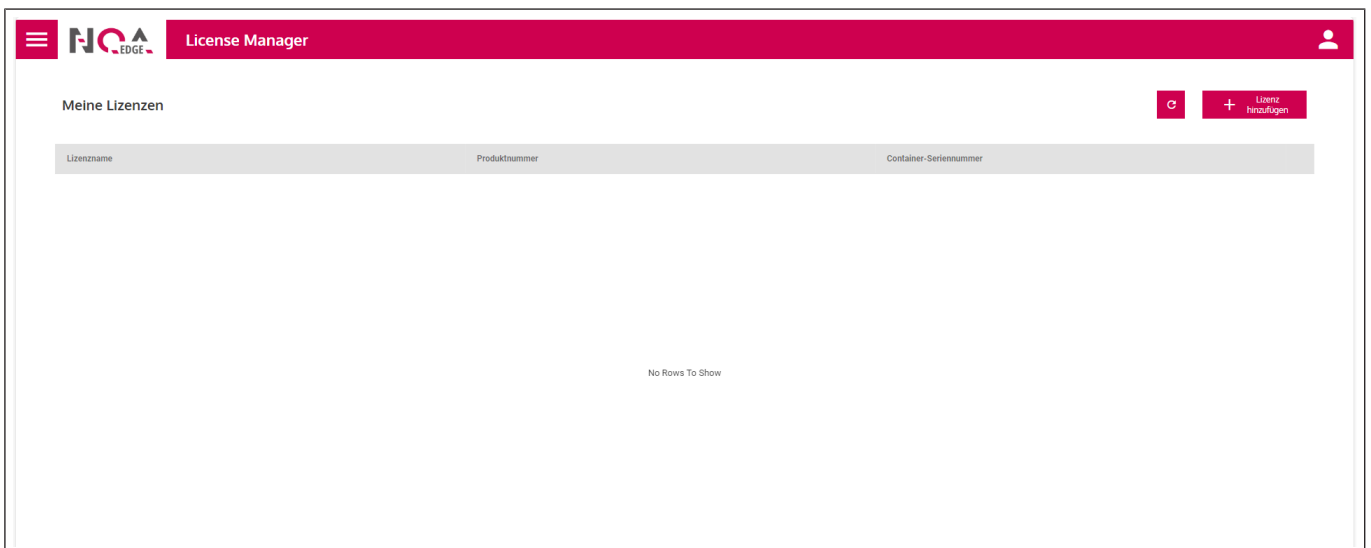

Fig. 33: Licence Manager - My licences

## 7.5 App Manager

### 7.5.1 Installed apps

The App Manager is used to display the installed apps. The status, current version and any available updates for the respective apps are also displayed.

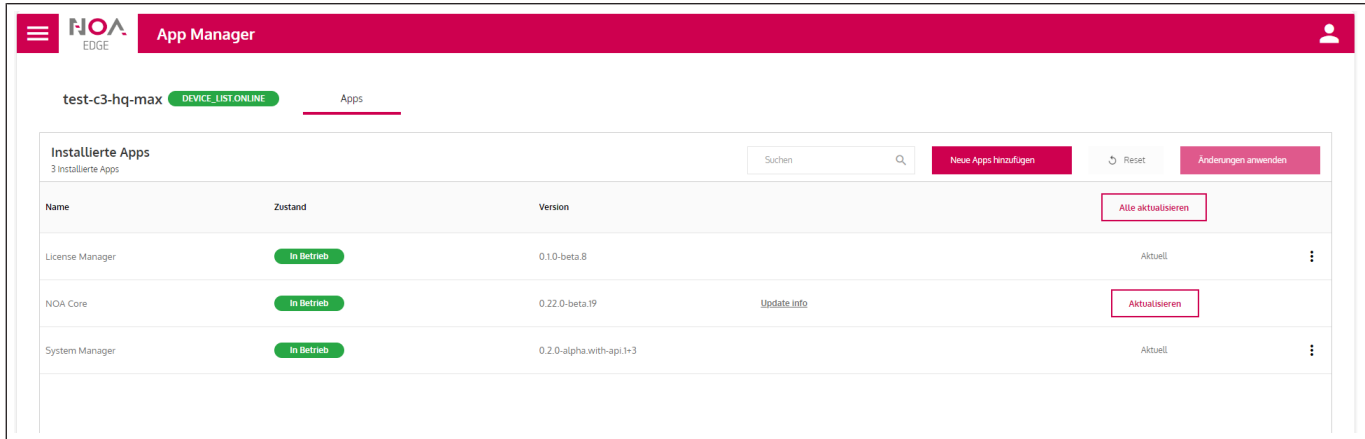

Fig. 34: App Manager - Installed apps

#### 7.5.1.1 Install apps

Click on **Add new apps** to open a catalog with the available apps.

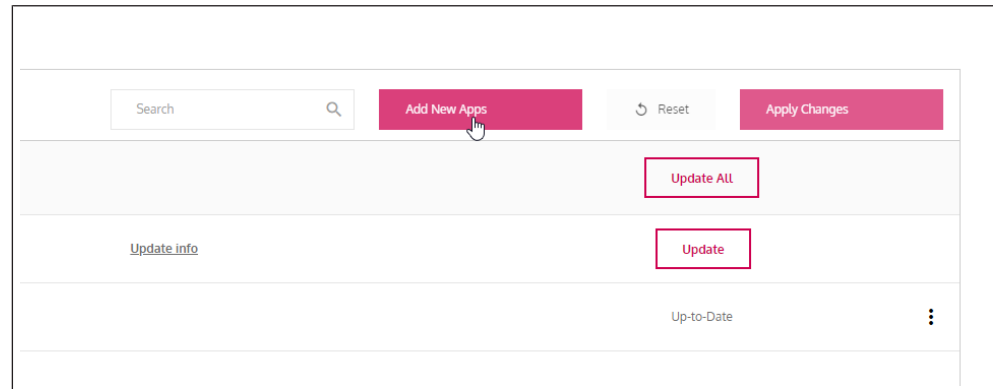

Fig. 35: Open the app catalog

By clicking on Add, one or more apps can be selected for installation. Click the Finished button to confirm the selection.

Click on **Apply changes** to install the app(s).

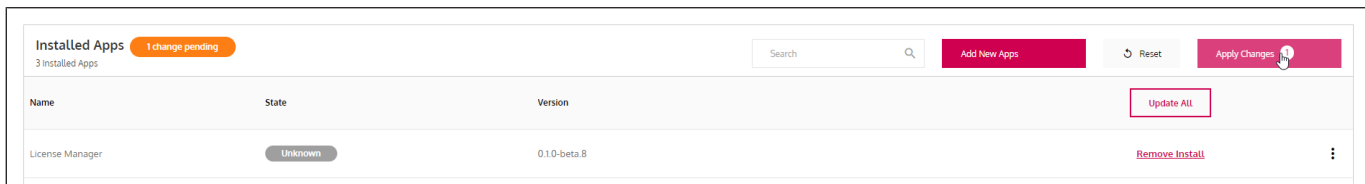

Fig. 36: Start installation of new apps

### 7.5.1.2 Delete apps

Apps are deleted in two steps:

- Mark the app(s) to be deleted.

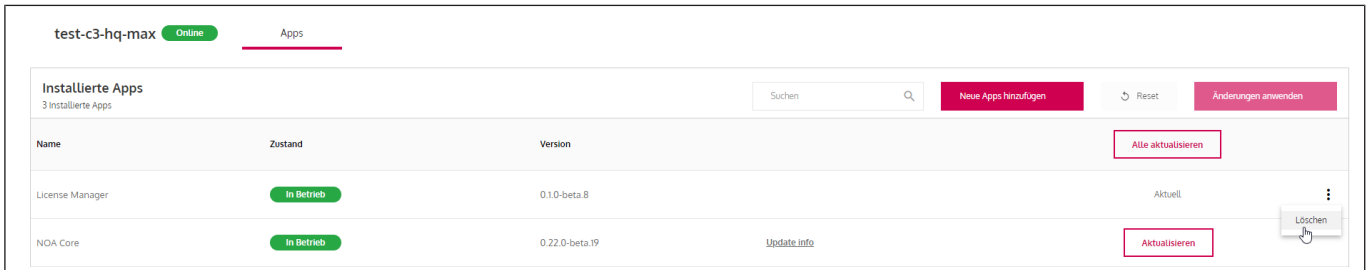

Fig. 37: Mark the app to be deleted

The number of selected apps is displayed in the button **Apply changes**.

- Delete  
Clicking on the button **Apply changes** starts the deletion.

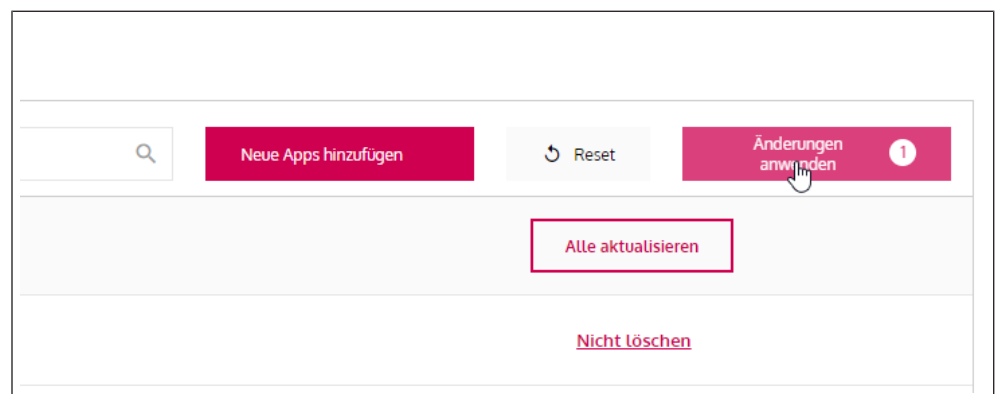

Fig. 38: Delete apps

## 7.6 IIoT Cloud

With NOA Core, the C6 COMPACT 3 has an optional interface to the IIoT cloud NOA Portal from KEB. With NOA Portal, you can enable further use cases for your machines. Possible use cases:

- Condition monitoring and alarming.
- Fleet and asset management.
- Remote maintenance via a VPN connection to the C6 COMPACT 3.

A special feature of NOA Portal is that you can individually configure your IIoT solution and only use the features that you really need for your application.

As an OEM, you have the option of providing your end customers with an instance of NOA Portal and allowing them to benefit from the features of NOA Portal.

Further information on NOA Portal can be found on the KEB website:

(🌐) ► <https://www.keb-automation.com/products/automation-iiot-plattform>)

Contact us if you are interested in NOA Portal and would like access:

(🌐) ► <https://www.keb-automation.com/forms/contact-form-noa>)



Fig. 39: NOA Portal

### 7.6.1 Device manager

Click on the **cogwheel** and **devices** to open the device manager.



Fig. 40: Open the device list

The device manager lists all installed devices with their name, serial number and location. Clicking on a row allows the corresponding device to be managed.

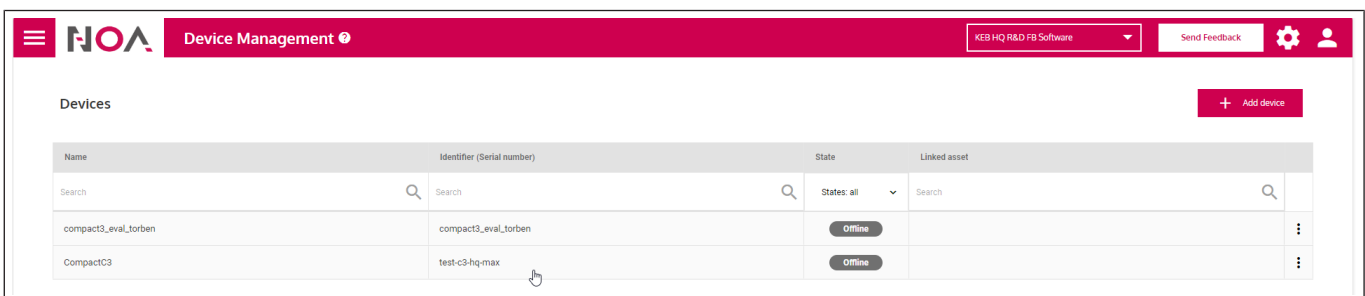

Fig. 41: Device manager with all installed devices

Further options can be selected by clicking on the three dots at the end of the line.

### 7.6.1.1 General information

General information such as the device name can be changed here. Notes about the device can also be noted.

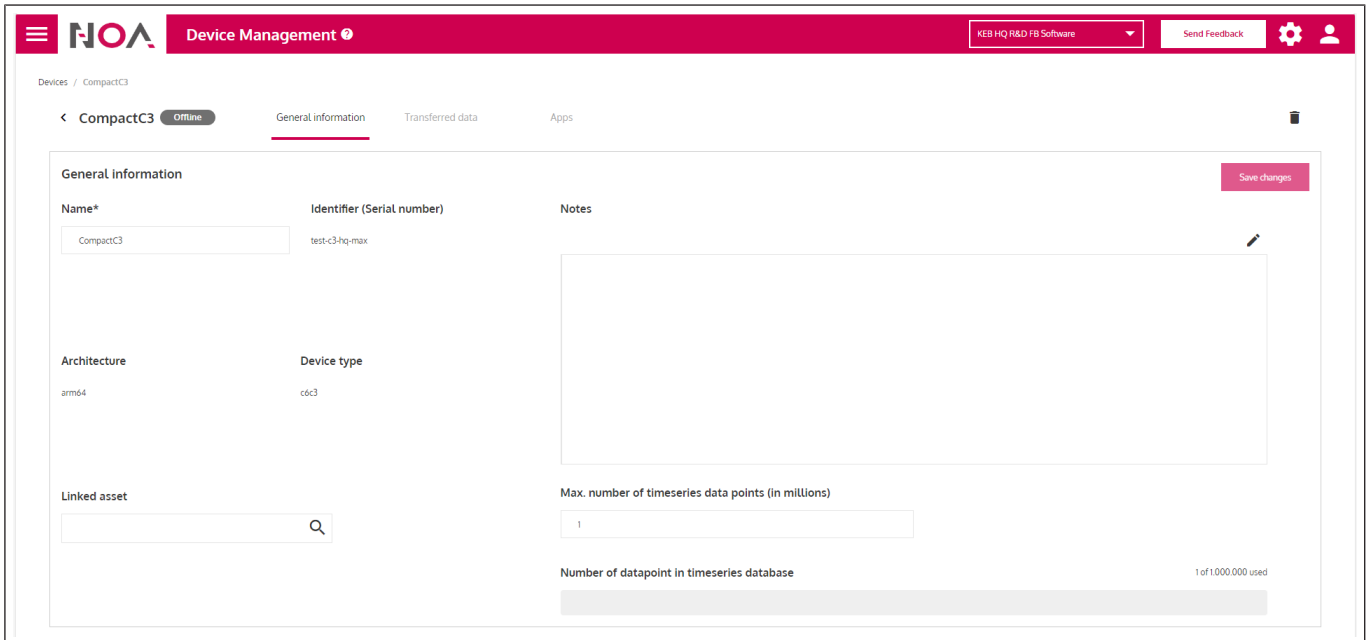

Fig. 42: Editing general information about the device

### 7.6.1.2 Transferred data

### 7.6.1.3 Apps

Cloud apps can be installed, removed and updated here. Operation is as in the App Manager.

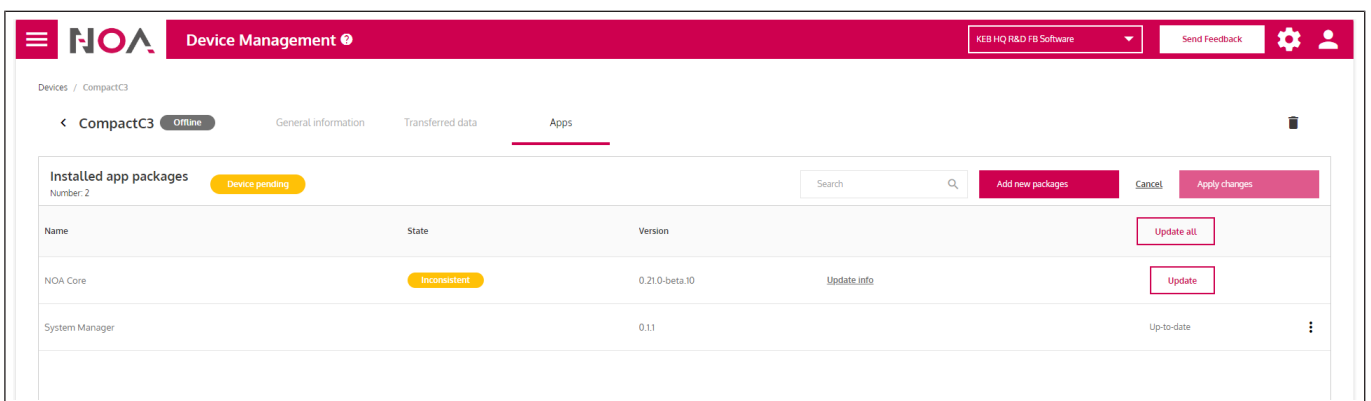

Fig. 43: Install, remove and update apps

## 8 Maintenance, service and disposal

**⚠ DANGER**



---

### Electrical voltage in the vicinity of the device!

#### Danger to life due to electric shock !

- ✓ This device is intended for installation in control cabinets or machines that can be operated under dangerous voltages. For any work on the device
    - a) Switch off the supply voltage of the control cabinet or machine.
    - b) Secure it against switching on.
    - c) Wait until all drives has been stopped in order that no regenerative energy can be generated.
    - d) Never bridge upstream protective devices. Also not for test purposes.
- 

### 8.1 Maintenance

The following maintenance work is to be carried out as required, but at least once a year, by authorised and trained personnel.

- Check unit for loose screws and plugs and tighten if necessary.
- Clean dirt and dust from the devices.
- Checking and cleaning the ventilation inlets and outlets.
- Examine and clean extracted air filter and cooling air filter of the control cabinet.

#### 8.1.1 Cleaning

- Switch off the power before any cleaning operation.
- Clean the front panel of the system with a soft damp cloth.
- Do not use cleaning agents or solvents or other objects that could attack or scratch the surface.

#### 8.1.2 Flash memory

The internal memory of the C6 COMPACT 3 is based on an eMMC.

With frequent write access, you can also use an external memory to extend the lifetime of the read-only memory.

Make regular backups so that you can access your data in the event of an error.

### 8.2 Service

In case of malfunction, unusual noises or smells inform a person in charge!

**⚠ DANGER**

---

### Unauthorized exchange, repair and modifications

#### Unpredictable malfunctions

- a) The function of the drive controller is dependent on its parameterisation. Never replace without knowledge of the application.
  - b) Modification or repair is permitted only by KEB Automation KG authorized personnel.
  - c) Only use original manufacturer parts.
  - d) Infringement will annul the liability for resulting consequences.
- 

In case of failure, please contact the machine manufacturer. He can

- supply a corresponding original device.
- supply an authorised replacement part.
- organise the maintenance.

### Technical support and repairs

KEB offers wide-ranging, complete after-sales technical support. The staff who deal with this handle questions on the entire range of products skilfully, quickly, and efficiently.

You can phone our staff in the service department, and they will give you complete, prompt advice on how to resolve your problems.

Telephone: +49 (0) 5263 401-0

Fax: +49 (0) 5263 401-116

E-Mail: (🌐) [service@keb.de](mailto:service@keb.de)

## 8.3 Disposal

Electronic devices of KEB Automation KG are intended for professional, commercial processing (so-called B2B devices).

Manufacturers of B2B devices are obliged to take back and recycle devices manufactured after 14.08.2018. In principle, these devices may not be left at public or communal recycling or collection points.



Unless otherwise agreed between the customer and KEB or unless there is a deviating mandatory legal regulation, KEB products labelled in this way can be returned. Company and keyword for the return point can be found in the list below.

Shipping costs are at the expense of the customer. The devices are then professionally recycled and disposed of.

The entry numbers are listed country-specifically in the following table. KEB addresses can be found on our website.

Withdrawal by	WEEE registration no.	Keyword
<b>Germany</b>		
KEB Automation KG	EAR: DE12653519	Keyword: "Withdrawal WEEE"
<b>France</b>		
RÉCYLUM – Recycle point	ADEME: FR021806	Mots clés "KEB DEEE"
<b>Italy</b>		
COBAT	AEE: (IT) 19030000011216	Parola chiave "Ritiro RAEE"
<b>Austria</b>		
KEB Automation GmbH	ERA: 51976	Keyword: "Withdrawal WEEE"
<b>Spain</b>		
KEB Automation KG	RII-AEE: 7427	Palabra clave "Retirada RAEE"
<b>Czech republic</b>		
KEB Automation KG	RETELA: 09281/20-ECZ	Klíčové slovo "Zpětný odběr OEEZ"
<b>Slovakia</b>		
KEB Automation KG	ASEKOL: RV22EEZ0000421	Kľúčové slovo: "Spätný odber OEEZ"

The packaging must be sent for paper and cardboard recycling.

## 9 Certification

### 9.1 CE marking

**see also**

 [EU Declaration of Conformity C6 COMPACT 3 \[▶ 57\]](#)



## 9.1.1 EU Declaration of Conformity C6 COMPACT 3

## EU DECLARATION OF CONFORMITY



dc.eu.co.c6be.v01.en  
17.12.2024

Manufacturer: KEB AUTOMATION KG  
Südstraße 38  
32683 Bartrup – Germany

Product: **C6 COMPACT 3**  
yy**C6BE**x - xxxx  
yy = 00; xx = 0-9 or A-Z

The designated product complies with the following directives and regulations of the European Union:

**2014/30/EU EMC Directive**  
DIRECTIVE 2014/30/EU OF THE EUROPEAN PARLIAMENT AND OF THE COUNCIL of 26 February 2014 on the harmonization of the laws of the Member States relating to electromagnetic compatibility (recast)

**2011/65/EU RoHS Directive**  
DIRECTIVE 2011/65/EU OF THE EUROPEAN PARLIAMENT AND OF THE COUNCIL of 8 June 2011 on the restriction of the use of certain hazardous substances in electrical and electronic equipment (recast)

Further information on compliance with these EU directives and regulations can be found in the annex, which is an integral part of this declaration of conformity. This declaration certifies conformity with the directives and regulations mentioned above, but does not constitute a guarantee of properties. The safety instructions in the supplied product documentation must be carefully observed.

This declaration of conformity is issued under the sole responsibility of the manufacturer.

Bartrup, 17.12.2024

Issued by:

X 

i.V./p.p. Mario Radtke  
Head of Product Conformity Electronics  
Signiert von: Mario Radtke

X 

i.A. Bastian Pukallus  
Head of Standards & Certification  
Signiert von: Bastian Pukallus

## EU DECLARATION OF CONFORMITY



### ANNEX 1

The conformity of the designated product with the provisions of the directives and regulations is demonstrated by full compliance with the following standards:

Directive or Regulation	Harmonized standard
EMC Directive 2014/30/EU	<b>EN 61131-2:2007</b> Programmable controllers - Part 2: Equipment requirements and tests (clauses 8, 9, 10)
RoHS Directive 2011/65/EU	<b>EN IEC 63000:2018</b> Technical documentation for the assessment of electrical and electronic products with respect to the restriction of hazardous substances

#### Informative standards considered (in parts)

IEC 61010-1:2010 +COR:2011 +A1:2016 +A1:2016/COR1:2019	Safety requirements for electrical equipment for measurement, control, and laboratory use - Part 1: General requirements; Amendment 1; Corrigendum 1
IEC 61010-2-201:2017	Safety requirements for electrical equipment for measurement, control, and laboratory use - Part 2-201: Particular requirements for control equipment
IEC 61131-2:2017	Industrial-process measurement and control - Programmable controllers - Part 2: Equipment requirements and tests

## 9.2 UK marking

In preparation

### 9.3 UL certification



Acceptance according to UL is marked on the nameplate by the adjacent logo.

To be conform according to UL for use on the North American and Canadian Market the following additionally instructions must be observed (original text of the UL-File):

**In preparation**

## 10 Revision History

Edition	Ver.	Note	FS
-	00	Prototype	N
2025-01	01	Pre-series version	N
2025-02	02	Terminal strip X5 renamed to X6. Series version created.	N

FS: (J) Version contains safety-related changes; (N) Version contains changes for product improvement or troubleshooting.

## Glossary

### 2W

2-Wire; is used in the field of network technology for serial full duplex operation.

### Application

The application is the intended use of the KEB product.

### Autonegotiation

Procedure for determining the max. transmission speed.

### CAN®

Serial bus system running protocols such as CANopen, Devicenet or J1939. CAN is a registered trademark of the CAN in AUTOMATION - International Users and Manufacturers Group e.V.

### COMBIVERT

Proper name for a KEB Drive Controller.

### Customer

The customer has purchased a product from KEB and integrates the KEB product into his product (customer product) or resells the KEB product (reseller).

### eMMC

Embedded Multi Media Card consisting of flash memory and memory controller.

### EN 60068-2-27

Environmental influences - Part 2-27: Test method - Test Ea and guideline: Shock. German version VDE 0468-2-27

### EN 60068-2-6

Environmental influences - Part 2-6: Test method - Test Fc: Oscillation (sinusoidal). German version VDE 0468-2-6.

### EN 60529

Degrees of protection provided by enclosures (IP-Code).

### EN IEC 61010-2-201

Safety requirements for electrical equipment for measurement, control, and laboratory use - Part 2: Particular requirements for control equipment. German version VDE 0411-2-201.

### EN 60715

Dimensions of low-voltage switchgear and controlgear -Standardized mounting on rails for mechanical support of electrical devices in switchgear and controlgear installations. German version VDE 0660-520.

### EN 61010-1

Safety requirements for electrical equipment for measurement, control and laboratory use - Part 1: General requirements.

### EtherCAT®



**EtherCAT®**

EtherCAT is a real-time Ethernet bus system. EtherCAT is a registered trademark and patented technology, licensed by Beckhoff Automation GmbH, Germany.

### Ethernet

Real-time bus system - defines protocols, plugs, types of cables

### HD 60364-4-41

Electrical installations of buildings Part 4-41 Protection for safety; Protection against electric shock. German version VDE 0100-410.

### HD 60364-5-54

Low-voltage electrical installations - Part 5-54: Selection and erection of electrical equipment - Earthing arrangements, protective conductors and protective bonding conductors. German version VDE 0100-540.

### HMI

Human-Machine-Interface describes a visual user interface (touchscreen).

**IDE**

---

Integrated Development Environment

**IEC 61131-2**

---

Programmable controllers - Part 2: Equipment requirements and tests (German version DIN EN 61131-2)

**IEC 61131-3**

---

Programmable controllers - Part 3: Programming languages (German version DIN EN 61131-3)

**NHN**

---

Standard altitude zero; related to the established height definition in Germany (DHHN2016). The international data usually deviate from this by only a few cm to dm, so that the value is given can be taken from the regionally applicable definition.

**PELV**

---

Safe protective extra-low voltage (earthed).

**RS485**

---

RS-485 is an industry standard according to EIA-485 for a physical interface for asynchronous, serial data transmission.

**RTC**

---

Real Time Clock

**SELV**

---

Safe extra-low voltage (unearthed).

**UPS**

---

Uninterruptible power supply for bridging power failures or to bring the device into a defined state.

## Index

### M

---

Maintenance work	54
------------------	----

### P

---

Packaging	55
-----------	----

### R

---

Return point	55
--------------	----

### U

---

UL	59
----	----

## Notes

---

---

---

---

---

---

---

---

---

---

---

---

---

---

---

---

---

---

---

---

---

---

---

---

---

---

---

---





MORE KEB PARTNERS WORLDWIDE:  
[www.keb-automation.com/contact](http://www.keb-automation.com/contact)





**Automation with Drive**

**[www.keb-automation.com](http://www.keb-automation.com)**

KEB Automation KG • Suedstraße 38 • D-32683 Barntrup • Tel: +49 5263 401-0 • E-Mail: [info@keb.de](mailto:info@keb.de)