



COMBIVERT H6

INSTRUCTIONS FOR USE | INSTALLATION H6 AXIS MODULES
POWER 0.75...110 KW

Translation of original manual
Document 20094353 EN 09



Preface

The hardware and software described in this document are products of KEB. The information contained in this document is valid at the time of publishing. KEB reserves the right to update this document in response to misprints, mistakes or technical changes.

Signal words and symbols

Certain procedures within this document can cause safety hazards during the installation or operation of the device. Refer to the safety warnings in this document when performing these procedures. Safety signs are also located on the device where applicable. A safety warning is marked by one of the following warning signs:

DANGER	Dangerous situation, which will cause death or serious injury if this safety warning is ignored.
WARNING	Dangerous situation, which may cause death or serious injury if this safety warning is ignored.
CAUTION	Dangerous situation, which may cause minor injury if this safety warning is ignored.
NOTICE	Situation, which can cause damage to property if this safety warning is ignored.

RESTRICTION

Used when the following statements depend on certain conditions or are only valid for certain ranges of values.



Used for informational messages or recommended procedures.

More symbols

- ▶ This arrow starts an action step.
- / - Enumerations are marked with dots or indents.
- => Cross reference to another chapter or another page.



Note to further documentation.
www.keb.de/service/downloads



Laws and guidelines

KEB Automation KG confirms with the EC declaration of conformity and the CE mark on the device nameplate that it complies with the essential safety requirements.

The EC declaration of conformity can be downloaded on demand via our website.

Warranty and liability

The warranty and liability on design, material or workmanship for the acquired device is given in the general sales conditions.



Here you will find our general sales conditions.
www.keb.de/terms-and-conditions



Further agreements or specifications require a written confirmation.

Support

Although multiple applications are referenced, not every case has been taking into account. If you require further information or if problems occur which are not referenced in the documentation, you can request the necessary information via the local KEB agency.

The use of our units in the target products is outside of our control and therefore lies exclusively in the area of responsibility of the customer.

The information contained in the technical documentation, as well as any user-specific advice in spoken and written and through tests, are made to best of our knowledge and information about the intended use. However, they are regarded as being only informal and changes are expressly reserved, in particular due to technical changes. This also applies to any violation of industrial property rights of a third-party. Selection of our units in view of their suitability for the intended use must be done generally by the user.

Tests can only be done within the intended end use of the product (application) by the customer. They must be repeated, even if only parts of hardware, software or the unit adjustment are modified.

Copyright

The customer may use the instructions for use as well as further documents or parts from it for internal purposes. Copyrights are with KEB and remain valid in its entirety.

This KEB product or parts thereof may contain third-party software, including free and/or open source software. If applicable, the license terms of this software are contained in the instructions for use. The instructions for use are already available to you, can be downloaded free of charge from the KEB website or can be requested from the respective KEB contact person.

Other wordmarks or/and logos are trademarks (™) or registered trademarks (®) of their respective owners.

Table of Contents

Preface	3
Signal words and symbols	3
More symbols.....	3
Laws and guidelines.....	4
Warranty and liability.....	4
Support	4
Copyright.....	4
Table of Contents	5
List of Figures	8
List of Tables	9
Glossary	10
Standards for drive controllers	12
Product standards that apply directly to the drive controller	12
Basic standards to which drive controller standards refer directly	12
Standards that are used in the environment of the drive controller.....	13
1 Basic Safety Instructions	14
1.1 Target group	14
1.2 Transport, storage and proper use	14
1.3 Installation	15
1.4 Electrical connection	16
1.4.1 EMC-compatible installation.....	17
1.4.2 Voltage test.....	17
1.4.3 Insulation measurement.....	17
1.5 Start-up and operation	18
1.6 Maintenance	19
1.7 Repair	20
1.8 Disposal	20
2 Product Description	21
2.1 Specified application	22
2.2 Unintended use	22
2.3 Product features	23
2.4 Type code	24
3 Technical Data	25
3.1 Operating conditions	25
3.1.1 Climatic environmental conditions.....	25
3.1.2 Mechanical environmental conditions	26
3.1.3 Chemical / mechanical active substances.....	26
3.1.4 Electrical operating conditions.....	27
3.1.4.1 Device classification	27

3.1.4.2 Electromagnetic compatibility	27
3.2 Technical data of the axis modules	28
3.3 DC link capacities	31
3.4 Mechanical installation	32
3.4.1 Control cabinet installation	32
3.4.1.1 Mounting instructions for control cabinet installation.....	33
3.4.2 Installation instructions for flat rear heat sink	33
3.4.3 Dimensions central heat sink	34
3.4.3.1 Air heat sink.....	34
3.4.3.2 Liquid heat sinks.....	34
3.4.4 Dimensions and weights of modules with flat rear heat sink.....	35
3.4.5 Dimensions of modules with air-cooled heat sink	36

4 Installation and Connection..... 40

4.1 Construction of the device	40
4.1.1 Status LEDs	45
4.1.1.1 Status-LED safety module.....	45
4.1.1.2 Status LED axis module	45
4.2 Connection of the power unit.....	46
4.2.1 Connection of the DC bus X1D	46
4.2.2 Connection of the 24V bus X1C	46
4.2.3 Connection of the motor	47
4.2.3.1 Motor terminal X1A.....	47
4.2.3.2 Selection of the motor cable.....	49
4.2.3.3 Interconnection of the motor.....	49
4.2.3.4 Terminal block X1B for motor temperature and brake control	50
4.2.3.5 Motor temperature detection	51
4.2.3.6 Use of the temperature input in KTY mode	51
4.2.3.7 Use of the temperature input in PTC mode.....	52
4.2.3.8 Brake control terminals B+, B-	52
4.2.3.9 Brake control terminals BA+, BA- and BB+, BB-.....	52
4.2.4 Encoder interfaces	53
4.2.4.1 Encoder interface X3AA (channel 1)	54
4.2.4.2 Encoder interface X3AA (channel 1) for HTL signals	55
4.2.4.3 Encoder interface X3AB (channel 2).....	55
4.2.4.4 Description of the encoder interfaces.....	56
4.3 Connection of the control.....	57
4.3.1 Error chain terminal X2C, X2D	57
4.3.1.1 Error chain (channel 1).....	57
4.3.1.2 Error power supply unit (channel 2)	57
4.3.1.3 Wiring example error chain	57
4.3.2 EtherCat system bus terminal X4B	58
4.3.3 Diagnosis/visualisation X4A	58

4.3.4 Digital inputs and outputs X2A	59
4.3.4.1 Technical data of the inputs	59
4.3.4.2 Technical data of the outputs	59
4.3.4.3 Assignment of the interfaces	59
4.3.5 Assembly of the wires to PUSH IN terminals	60
4.3.5.1 Assignment of the terminal block X2A	61
4.3.5.2 Connection of the digital inputs	61
4.3.5.3 Connection of the digital outputs	61
4.3.5.4 Example for the control of digital inputs and digital outputs	61
4.4 Safety module terminal block X2B.....	62
4.4.1 General instructions for safety modules	62
4.4.2 Module type 0 terminal block X2B.....	63
4.4.2.1 Control release	63
4.4.2.2 Brake control	63
4.4.3 Module type 1 and 2.....	63
5 Cooling System.....	64
5.1 Installation of water-cooled units	64
5.1.1 Heat sink and operating pressure	64
5.1.2 Materials in the cooling circuit	64
5.1.3 Requirements on the coolant	65
5.1.3.1 Special requirements for open and half-open cooling systems:.....	66
5.1.4 Connection to the cooling system	66
5.1.5 Coolant temperature and moisture condensation	66
5.1.6 Emptying the cooling circuit.....	67
5.1.7 Coolant heating depending on power dissipation and flow rate with water.....	68
5.1.8 Typically fall of pressure depending on the rate of flow.....	68
6 Certification.....	69
6.1 CE-Marking.....	69
6.2 UR-Marking	69
6.3 UL and UR-Marking	70
6.4 Further informations and documentation	71
7 Revision History	72

List of Figures

Figure 1:	Overload characteristic (E.OL, E.OL2)	28
Figure 2:	Control cabinet installation	32
Figure 3:	Main heat sink for COMBIVERT H6	34
Figure 4:	Dimensions and weights of the axis modules	35
Figure 5:	Dimensions and weights housing P	36
Figure 6:	Dimensions and weights housing S	37
Figure 7:	Dimensions and weights housing U	38
Figure 8:	Dimensions and weights housing W	39
Figure 9:	Front view of the device	40
Figure 10:	Connections of the front side	41
Figure 11:	View rear side of the device housing B/P	42
Figure 12:	View rear side of the device	43
Figure 13:	Top view of the device	44
Figure 14:	Status LEDs	45
Figure 15:	Connection of the DC bus	46
Figure 16:	Connection of the 24V bus	46
Figure 17:	Housing B/P motor connection	47
Figure 18:	Housing C/S motor connection	48
Figure 19:	Housing E/U motor connection	48
Figure 20:	Housing G/W motor connection	48
Figure 21:	Interconnection of the motor	49
Figure 22:	Connection of motor and voltage supply	50
Figure 23:	Terminal block X1B	50
Figure 24:	Connection of a KTY sensor	51
Figure 25:	Brake control terminals B+, B-	52
Figure 26:	Brake control terminals BA+, BA- and BB+, BB-	52
Figure 27:	Encoder interfaces of housings B/P	53
Figure 28:	Encoder interfaces of housings C/S, E/U and G/W	53
Figure 29:	Encoder interface X3AA (channel 1)	54
Figure 30:	Encoder interface X3AA (channel 1) for HTL signals	55
Figure 31:	Error chain terminal X2C, X2D	57
Figure 32:	Wiring example error chain	57
Figure 33:	Assignment of the interfaces	59
Figure 34:	Assembly of the control cable	60
Figure 35:	Assignment of the terminal block X2A	61
Figure 36:	Connection of the digital inputs DI 1...DI4	61
Figure 37:	Connection of the digital outputs DO 1...DO4	61
Figure 38:	Example for the control of digital inputs and digital outputs	61
Figure 39:	Safety module type 0 terminal block X2B (top view)	63
Figure 40:	Connection of the control release via switch and PLC	63
Figure 41:	Connection of a brake release via switch and PLC	63
Figure 42:	Coolant heating depending on power dissipation	68
Figure 43:	Typically fall of pressure depending on the rate of flow	68

List of Tables

Table 1:	Type code	24
Table 2:	Climatic environmental conditions	25
Table 3:	Mechanical environmental conditions	26
Table 4:	Chemical / mechanical active substances	26
Table 5:	Device classification.....	27
Table 6:	Electromagnetic compatibility	27
Table 7:	Overview of the device data housing B, P	28
Table 8:	Overview of the device data housing C, S	29
Table 9:	Overview of the device data housing E, G, U, W.....	30
Table 10:	DC link capacities	31
Table 11:	Mounting instructions for control cabinet installation	33
Table 12:	Status-LED safety module	45
Table 13:	Status LED axis module.....	45
Table 14:	Motor temperature detection	51
Table 15:	Wiring example in PTC mode	52
Table 16:	Description of the encoder interfaces	56
Table 17:	EtherCat System bus socket X4B.....	58
Table 18:	Diagnosis/visualisation X4A.....	58
Table 19:	Technical data of the digital output.....	59
Table 20:	Wire-end ferrules and stripping length	60
Table 21:	Safety module terminal block X2B general information	62
Table 22:	Electrochemical series / standard potentials against hydrogen	65
Table 23:	Requirements on the coolant.....	65
Table 24:	Special requirements for open and semi-open cooling systems	66
Table 25:	Dew point table	67

Glossary

0V	Earth-potential-free common point	Endat	Bidirectional encoder interface of the company Heidenhain
1ph	1-phase mains	EtherCAT	Real-time Ethernet bus system of the company Beckhoff
3ph	3-phase mains	Ethernet	Real-time bus system - defines protocols, plugs, types of cables
AC	AC current or voltage	FE	Functional earth
AFE	From 07/2019 AIC replaces the previous name AFE	FSoE	Functional Safety over Ethernet
AFE filter	From 07/2019 AIC filter replaces the previous name AFE filter	FU	Drive controller
AIC	Active Infeed Converter	GND	Reference potential, ground
AIC filter	Filter for Active Infeed Converter	GTR7	Braking transistor
Application	The application is the intended use of the KEB product	HF filter	High frequency filter to the mains
ASCL	Asynchronous sensorless closed loop	Hiperface	Bidirectional encoder interface of the company Sick-Stegmann
Auto motor ident.	Automatically motor identification; calibration of resistance and inductance	HMI	Human machine interface (touch screen)
AWG	American wire gauge	HSP5	Fast, serial protocol
B2B	Business-to-business	HTL	Incremental signal with an output voltage (up to 30V) -> TTL
BiSS	Open source real-time interface for sensors and actuators (DIN 5008)	IEC	International standard
CAN	Fieldbus system	IP xx	Degree of protection (xx for level)
CDF	Cyclic duration factor	KEB product	The KEB product is subject of this manual
CDM	Complete drive module including auxiliary equipment (control cabinet)	KTY	Silicium temperature sensor (polarized)
COMBIVERT	KEB drive controller	Manufacturer	The manufacturer is KEB, unless otherwise specified (e.g. as manufacturer of machines, engines, vehicles or adhesives)
COMBIVIS	KEB start-up and parameterizing software	MCM	American unit for large wire cross sections
Customer	The customer has purchased a KEB product from KEB and integrates the KEB product into his product (customer product) or resells the KEB product (dealer)	Modulation	Means in drive technology that the power semiconductors are controlled
DC	DC current or voltage	MTTF	Mean service life to failure
DI	Demineralized water, also referred to as deionized (DI) water	NN	Sea level
DIN	German Institut for standardization	OC	Overcurrent
DS 402	CiA DS 402 - CAN device profile for drives	OH	Overheat
EMC	Electromagnetic compatibility	OL	Overload
Emergency stop	Shutdown of a drive in emergency case (not de-energized)	OSSD	Output signal swithching device; - an output signal that is checked in regular intervals on its shutdown. (safety technology)
Emergency switching off	Switching off the voltage supply in emergency case	PDS	Power drive system incl. motor and measuring probe
EMS	Energy Management System	PE	Protective earth
EN	European standard	PELV	Protective Extra Low Voltage
Encoder emulation	Software-generated encoder output	PFD	Term used in the safety technology (EN 61508-1...7) for the size of error probability
End customer	The end customer is the user of the customer product		

PFH	Term used in the safety technology (EN 61508-1...7) for the size of error probability per hour
PLC	Programmable logic controller
Pt100	Temperature sensor with $R_0=100\Omega$
Pt1000	Temperature sensor with $R_0=1000\Omega$
PTC	PTC-resistor for temperature detection
PWM	Pulse width modulation
RJ45	Modular connector with 8 lines
SCL	Synchronous sensorless closed loop
SELV	Safety Extra Low Voltage (<60 V)
SIL	The safety integrity level is a measure for quantifying the risk reduction. Term used in the safety technology (EN 61508 -1...7)
SS1	Safety function „Safe stop 1“ in accordance with IEC 61800-5-2
SSI	Synchronous serial interface for encoder
STO	Safety function „Safe Torque Off“ in accordance with IEC 61800-5-2
TTL	Incremental signal with an output voltage up to 5V
USB	Universal serial bus
VARAN	Real-time Ethernet bus system

Standards for drive controllers

Product standards that apply directly to the drive controller

EN61800-2	Adjustable speed electrical power drive systems - Part 2: General requirements - Rating specifications for low voltage adjustable frequency a.c. power drive systems (VDE 0160-102, IEC 61800-2)
EN61800-3	Speed-adjustable electrical drives. Part 3: EMC requirements and specific test methods (VDE 0160-103, IEC 61800-3)
EN61800-5-1	Adjustable speed electrical power drive systems - Part 5-1: Safety requirements - Electrical, thermal and energy (IEC 61800-5-1); German version EN 61800-5-1
EN61800-5-2	Adjustable speed electrical power drive systems - Part 5-2: Safety Requirements - Functional (IEC 22G/264/CD)
UL61800-5-1	American version of the EN61800-5-1 with „National Deviations“

Basic standards to which drive controller standards refer directly

EN 55011	Industrial, scientific and medical equipment - Radio frequency disturbance characteristics - Limits and methods of measurement (CISPR 11); German version EN 55011
EN 55021	Interference to mobile radiocommunications in the presence of impulse noise - Methods of judging degradation and measures to improve performance (IEC/ CISPR/D/230/FDIS); German version prEN 55021
EN 60529	Degrees of protection provided by enclosures (IP Code) (IEC 60529)
EN 60664-1	Insulation coordination for equipment within low-voltage systems Part 1: Principles, requirements and tests (IEC 60664-1)
EN 60721-3-1	Classification of environmental conditions - Part 3-1: Classification of groups of environmental parameters and their severities - Section 1: Storage (IEC 60721-3-1); German version EN 60721-3-1
EN 60721-3-2	Classification of environmental conditions - Part 3: Classification of groups of environmental parameters and their severities - Section 2: Transportation and handling (IEC 104/670/CD)
EN 60721-3-3	Classification of environmental conditions - Part 3: Classification of groups of environmental parameters and their severities; section 3: Stationary use at weatherprotected locations; Amendment A2 (IEC 60721-3-3); German version EN 60721-3-3
EN 61000-2-1	Electromagnetic compatibility (EMC) - Part 2: Environment - Section 1: Description of the environment - Electromagnetic environment for low-frequency conducted disturbances and signalling in public power supply systems
EN 61000-2-4	Electromagnetic compatibility (EMC) - Part 2-4: Environment; Compatibility levels in industrial plants for low-frequency conducted disturbances (IEC 61000-2-4); German version EN 61000-2-4
EN 61000-4-2	Electromagnetic compatibility (EMC) - Part 4-2: Testing and measurement techniques - Electrostatic discharge immunity test (IEC 61000-4-2); German version EN 61000-4-2
EN 61000-4-3	Electromagnetic compatibility (EMC) - Part 4-3: Testing and measurement techniques - Radiated, radio-frequency, electromagnetic field immunity test (IEC 61000-4-3); German version EN 61000-4-3
EN 61000-4-4	Electromagnetic compatibility (EMC) - Part 4-4: Testing and measurement techniques - Electrical fast transient/burst immunity test (IEC 61000-4-4); German version EN 61000-4-4

EN61000-4-5	Electromagnetic compatibility (EMC) - Part 4-5: Testing and measurement techniques - Surge immunity test (IEC 61000-4-5); German version EN 61000-4-5
EN61000-4-6	Electromagnetic compatibility (EMC) - Part 4-6: Testing and measurement techniques - Immunity to conducted disturbances, induced by radio-frequency fields (IEC 61000-4-6); German version EN 61000-4-6
EN61000-4-34	Electromagnetic compatibility (EMC) - Part 4-34: Testing and measurement techniques - Voltage dips, short interruptions and voltage variations immunity tests for equipment with mains current more than 16 A per phase (IEC 61000-4-34); German version EN 61000-4-34
EN61508-1...7	Functional safety of electrical/electronic/programmable electronic safety-related systems – Part 1...7 (VDE 0803-1...7, IEC 61508-1...7)
EN62061	Safety of machinery - functional safety of electrical, electronic and programmable electronic safety-related systems (VDE 0113-50, IEC 62061)
EN ISO 13849-1	Safety of machinery - safety-related parts of control systems - Part 1: General principles for design (ISO 13849-1); German version EN ISO 13849-1

Standards that are used in the environment of the drive controller

DGUV regulation 3	Electrical installations and equipment
DIN IEC 60364-5-54	Low-voltage electrical installations - Part 5-54: Selection and erection of electrical equipment - Earthing arrangements, protective conductors and protective bonding conductors (IEC 64/1610/CD)
DIN VDE 0100-729	Low-voltage electrical installations - Part 7-729: Requirements for special installations or locations - Operating or maintenance gangways (IEC 60364-7-729:2007, modified); German implementation HD 60364-7-729:2009
DNVGL-CG-0339	Environmental test specification for electrical, electronic and programmable equipment and systems
EN 1037	Safety of machinery - Prevention of unexpected start-up; German version EN 1037
EN 12502-1...5	Protection of metallic materials against corrosion - Part 1...5
EN 60204-1	Safety of machinery - electrical equipment of machines Part 1: General requirements (VDE 0113-1, IEC 44/709/CDV)
EN 60439-1	Low-voltage switchgear and controlgear assemblies - Part 1: Type-tested and partially type-tested assemblies (IEC 60439-1); German version EN 60439-1
EN 60947-7-1	Low-voltage switchgear and controlgear - Part 7-1: Ancillary equipment - Terminal blocks for copper conductors (IEC 60947-7-1:2009); German version EN 60947-7-1:2009
EN 60947-8	Low-voltage switchgear and controlgear - Part 8: Control units for built-in thermal protection (PTC) for rotating electrical machines (IEC 60947-8:2003 + A1:2006 + A2:2011)
EN 61373	Railway applications - Rolling stock equipment - Shock and vibration tests (IEC 61373); German version EN 61373
EN 61439-1	Low-voltage switchgear and controlgear assemblies - Part 1: General rules (IEC 121B/40/CDV); German version FprEN 61439-1
VGB R 455 P	Water treatment and use of materials in cooling systems
DIN EN 60939-1	Passive filter units for electromagnetic interference suppression - Part 1: Generic specification (IEC 60939-1:2010); German version EN 60939-1:2010

1 Basic Safety Instructions

The COMBIVERT is designed and constructed in accordance with state-of-the-art technology and the recognized safety rules and regulations. However, the use of such devices may cause functional hazards for life and limb of the user or third parties, or damages to the system and other material property.

The following safety instructions have been created by the manufacturer for the area of electric drive technology. They can be supplemented by local, country- or application-specific safety instructions. This list is not exhaustive. Violation of the safety instructions by the customer, user or other third party leads to the loss of all resulting claims against the manufacturer.

NOTICE



Hazards and risks through ignorance.

- ▶ Read the instructions for use !
- ▶ Observe the safety and warning instructions !
- ▶ If anything is unclear, please contact KEB Automation KG !

1.1 Target group

This instruction manual is determined exclusively for electrical personnel. Electrical personnel for the purpose of this instruction manual must have the following qualifications:

- Knowledge and understanding of the safety instructions.
- Skills for installation and assembly.
- Start-up and operation of the product.
- Understanding of the function in the used machine.
- Detection of hazards and risks of the electrical drive technology.
- Knowledge of *DIN IEC 60364-5-54*.
- Knowledge of national safety regulations.

1.2 Transport, storage and proper use

The transport is carried out by qualified persons in accordance with the environmental conditions specified in this manual. Drive controller shall be protected against excessive strains.



Transport of drive controllers with an edge length >75 cm

The transport by forklift without suitable tools can cause a deflection of the heat sink. This leads to premature aging or destruction of internal components.

- ▶ Transport of drive controllers on suitable pallets.
- ▶ Do not stack drive controllers or burden them with other heavy objects.

NOTICE

Damage to the coolant connections

Bending of the tubes!

- ▶ Never place the device on the coolant connections



Drive controllers contain electrostatic sensitive components.

- ▶ Avoid contact.
 - ▶ Wear ESD-protective clothing.
-

Do not store drive controllers

- in the environment of aggressive and/or conductive liquids or gases.
- with direct sunlight.
- outside the specified environmental conditions.

1.3 Installation

⚠ DANGER

Do not operate in an explosive environment!

- ▶ The COMBIVERT is not intended for the use in potentially explosive environment.
-

⚠ CAUTION

Design-related edges and high weight!
Contusions and bruises!

- ▶ Never stand under suspended loads.
 - ▶ Wear safety shoes.
 - ▶ Secure drive controller accordingly when using lifting gear.
-

To prevent damages to the device:

- Make sure that no components are bent and/or isolation distances are changed.
- The device must not be put into operation in case of mechanical defects.
- Do not allow moisture or mist to penetrate the unit.
- Avoid dust permeating the device. Allow for sufficient heat dissipation if installed in a dust-proof housing.
- Note installation position and minimum distances to surrounding elements. Do not cover the ventilation openings.
- Mount the drive controller according to the specified degree of protection.
- Make sure that no small parts fall into the COMBIVERT during assembly and wiring (drilling chips, screws etc.). This also applies to mechanical components, which can lose small parts during operation.
- Check the reliable fit of the device connections in order to avoid contact resistances and sparking.
- Do not walk-on drive controller.
- Follow all safety instructions!

1.4 Electrical connection

⚠ DANGER**Voltage at the terminals and in the device !****Danger to life due to electric shock !**

- ▶ Never work on the open device or never touch exposed parts.
- ▶ For any work on the unit switch off the supply voltage, secure it against switching on and check absence of voltage by measurement.
- ▶ Wait until all drives has been stopped in order that no regenerative energy can be generated.
- ▶ Await capacitor discharge time (5 minutes) if necessary, measure DC voltage at the terminals.
- ▶ If personal protection is required, install suitable protective devices for drive converters.
- ▶ Never bridge upstream protective devices (also not for test purposes).
- ▶ Connect the protective earth conductor always to drive converter and motor.
- ▶ Install all required covers and protective devices for operation.
- ▶ The control cabinet shall be kept closed during operation.
- ▶ Residual current: This product may cause a dc current in the protective earth conductor. When a residual current protective device (RCD) or a residual current monitoring device (RCM) is used for the protection against direct or indirect contact, only a RCD or RCM type B is permitted on the power supply side of this product.
- ▶ Drive converters with a leakage current $> 3.5\text{mA AC}$ current (10mA DC current) are intended for a stationary connection. Protective earth conductors must be designed in accordance with the local regulations for equipment with high leakage currents according to *EN 61800-5-1*, *EN 60204-1* or *DIN IEC 60364-5-54*.



If personnel protection is required during installation of the system, suitable protective devices must be used for drive controllers.

www.keb.de/fileadmin/media/Techinfo/dr/tn/ti_dr_tn-rcd-00008_en.pdf



Installations which include drive controller shall be equipped with additional control and protective devices in accordance with the relevant applicable safety requirements, e.g. act respecting technical equipment, accident prevention rules etc. They must always be complied with, also for drive controller bearing a CE marking.

For a trouble-free and safe operation, please pay attention to the following instructions:

- The electrical installation shall be carried out in accordance with the relevant requirements.
- Cable cross-sections and fuses must be dimensioned by the user according to the specified minimum/maximum values for the application.
- The wiring must be made with flexible copper cable for a temperature $> 75^{\circ}\text{C}$.
- Connection of the drive converter is only permissible on symmetrical networks with a maximum line voltage (L1, L2, L3) with respect to earth (N/PE) of max. 300 V. An isolating transformer must be used for supply networks which exceed this value! In case of non-compliance the control is not longer considered to be a PELV circuit.
- With existing or newly wired circuits the person installing the units or machines must ensure that the PELV requirements are met.
- For drive converters that are not isolated from the supply circuit (in accordance with [EN 60721-3-2](#)) all control lines must be included in other protective measures (e.g. double insulation or shielded, earthed and insulated).
- When using components without isolated inputs/outputs, it is necessary that equipotential bonding exists between the components to be connected (e.g. by the equipotential line). Disregard can cause destruction of the components by equalizing currents.

1.4.1 EMC-compatible installation

Observance of the limit values required by EMC law is the responsibility of the customer.



Notes on EMC-compatible installation can be found here.
www.keb.de/fileadmin/media/Manuals/dr/emv/0000neb0000.pdf



1.4.2 Voltage test

Testing with AC voltage (in accordance with [EN 60204-1](#) chapter 18.4) may not be executed, since there is danger for the power semiconductors in the drive controller.



Due to the radio interference suppression capacitors, the test generator will switch off immediately with a current fault.



According to [EN 60204-1](#) it is permissible to disconnect already tested components. Drive controllers of the KEB Automation KG are delivered ex works voltage tested to 100% according to product standard.

1.4.3 Insulation measurement

An insulation measurement (in accordance with [EN 60204-1](#) chapter 18.3) with DC 500 V is permissible, if all power unit connections (grid-connected potential) and all control connections are bridged with PE. The insulation resistance of the respective device can be found in the technical data.

1.5 Start-up and operation

The drive controller must not be started until it is determined that the installation complies with the machine directive; Account is to be taken of [EN 60204-1](#).

⚠ WARNING

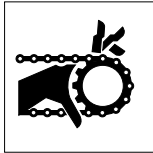

Software protection and programming!

Hazards caused by unintentional behavior of the drive!

- ▶ Check especially during initial start-up or replacement of the drive controller if parameterization is compatible to application.
- ▶ Securing a unit solely with software-supported functions is not sufficient. It is imperative to install external protective measures (e.g. limit switch) that are independent of the drive controller.
- ▶ Secure motors against automatic restart.

⚠ CAUTION



High temperatures at heat sink and coolant!

Burning of the skin!

- ▶ Cover hot surfaces safe-to-touch.
- ▶ If necessary, attach warning signs on the system.
- ▶ Before touching, check the surface and coolant lines.
- ▶ Before working let the unit cool down.

- During operation, all covers and doors shall be kept closed.
- Use only approved accessories for this device.
- Never touch terminals, busbars or cable ends.



If a drive controller with electrolytic capacitors in a DC link has not been in operation for more than one year, observe the following instructions.

www.keb.de/fileadmin/media/Techinfo/dr/tn/ti_dr_tn-format-capacitors-00009_en.pdf



NOTICE

Continuous operation (S1) with load > 60%!

Premature ageing of the electrolytic capacitors!

- ▶ Insert mains choke with $U_k = 4\%$.
- ▶ From a rated motor power of 55 kW, a mains choke with $U_k = 4\%$ must be used!

Switching at the output

Switching between motor and drive controller is prohibited for single drives during operation as this may trigger the protection gear of the device. Function ‚speed search‘ must be activated if switching can not be avoided. Speed search may only be triggered after closing the motor contactor (e.g. by switching the control release).

Connecting and disconnecting is permissible with multiple motor drives if at least 1 motor is running during the switch-over process. The drive controller must be dimensioned to the occurring starting currents.

The ‚speed search‘ function must be activated if the motor is still running during a restart of the drive controller (mains on) (e.g. due to large rotating masses).

Switching at the input

For applications that require cyclic switching off and on of the drive controller, maintain an off-time of at least 5 min after the last switch on. If you require shorter cycle times please contact KEB Automation KG.

Short-circuit resistance

The drive converters are conditional short-circuit proof. After resetting the internal protection devices, the function as directed is guaranteed.

Exceptions:

- If an earth-leakage fault or short-circuit often occurs at the output, this can lead to a defect in the unit.
- If a short-circuit occurs during regenerative operation (2nd or 4th quadrant, regeneration into the DC link), this can lead to a defect in the unit.

1.6 Maintenance

The following maintenance work has to be carried out when required, but at least once per year by authorized and trained personnel. Check unit for loose screws and plugs and tighten if necessary.

- ▶ Check system for loose screws and plugs and tighten if necessary.
- ▶ Clean drive controller from dirt and dust deposits. Pay attention especially to cooling fins and protective grid of the fans.
- ▶ Examine and clean extracted air filter and cooling air filter of the control cabinet.
- ▶ Check the function of the fans of the drive controller. The fan must be replaced in case of audible vibrations or squeak.
- ▶ In the case of liquid-cooled drive controllers a visual test of the cooling circuit for leaks and corrosion must be carried out. The cooling circuit must be completely empty if a unit shall be switched off for a longer period. The cooling circuit must be blown out additionally with compressed air at temperatures below 0°C.

1.7 Repair

In case of malfunction, unusual noises or smells inform a person in charge!

DANGER



Unauthorized exchange, repair and modifications!

Unpredictable malfunctions!

- ▶ The function of the drive controller is dependent on its parameterization. Never replace without knowledge of the application.
- ▶ Modification or repair is permitted only by KEB Automation KG authorized personnel.
- ▶ Only use original manufacturer parts.
- ▶ Infringement will annul the liability for resulting consequences.

In case of failure, please contact the machine manufacturer. Only the machine manufacturer knows the parameterisation of the used drive controller and can provide an appropriate replacement or induce the maintenance.

1.8 Disposal

Electronic devices of the KEB Automation KG are exclusively professional devices for further industrial processing (so-called B2B devices).

Manufacturers of B2B devices are obliged to take back and recycle devices manufactured after 14.08.2018. These devices may not be disposed at the collection centres of public sector disposal organisations.

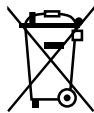

If no deviating agreement has been made between the customer and KEB or no deviating mandatory legal regulation exists, KEB products marked in this way can be returned. Company and keyword to the return point can be taken from the list below. Shipping costs are paid by the customer. Thereupon the devices will be professionally recycled and disposed.

The entry numbers are listed country-specific in the following table. The corresponding KEB return addresses can be found on our website.

Withdrawal by	WEEE-Reg.-No.	Keyword
Austria		
KEB Automation GmbH	ERA: 51976	Stichwort „Rücknahme WEEE“
France		
RÉCYLUM - Recycle point	ADEME: FR021806	Mots clés „KEB DEEE“
Germany		
KEB Automation KG	EAR: DE12653519	Stichwort „Rücknahme WEEE“
Italy		
COBAT	AEE: (IT) 19030000011216	Parola chiave „Ritiro RAEE“
Spain		
KEB Automation KG	RII-AEE 7427	Palabra clave „Retirada RAEE“
Česko		
KEB Automation KG	RETELA 09281/20 ECZ	Klíčové slovo: Zpětný odběr OEEZ
Slowakei		
KEB Automation KG	ASEKOL: RV22EEZ0000421	Klíčové slovo: "Spätný odber OEEZ"

The packaging must be feed to paper and cardboard recycling.

2 Product Description

The product family COMBIVERT H6 is optimized for the use in multi-axis drives. The structure is modular and thus it can be optimally adapted to the respective requirements. A system consists of the following components:

Name	Function
Rectifier module	Used to supply the main energy flow of DC-coupled drive converters. Consists of a B6 diode or thyristor bridge with following DC link for buffering the energy. The input is supplied with mains voltage. The DC output voltage is equal to the DC link potential. The energy flow is only possible in one direction (no regeneration). The rectifier module controls the precharging. It is used if no Active Front End module (AIC) is used. An integrated braking transistor can convert energy into heat by means of a braking resistor.
Charging module	Used for precharging the DC link in the DC-bus connection of drive converters. The charging module is used in conjunction with an Active Front End module (AIC). It switches and monitors the mains contactor after successful precharging. An integrated braking transistor can convert energy into heat via a braking resistor.
Active Front End Module (AIC)	From 07/2019 the term AIC replaces the previously used term AFE. Used to supply the main energy flow of DC-coupled drive converters. The input is supplied with mains voltage. The DC output voltage is equal to the DC link potential. The energy flow is possible in two directions (power supply and regeneration).The AIC can regenerate excess energy in sinusoidal form from the DC-bus connection into the mains. Precharging is required when using an AIC.
24V power supply module	Provides the 24V DC power supply for the individual modules. The input is supplied from the mains / DC bus. The 24V power supply module can be omitted if an existing 24V supply is to be used.
Control module with 24V power supply	The control module is used for decentralised control of a H6 device network. The H6 control module can be used as gateway between an external fieldbus and system bus. An integrated 24V power supply supplies the 24V bus.
Single axis module	Module for controlling a single drive axis in a drive system. The single axis module is supplied via the DC link bus. Single axis modules are available in different housing designs and performance levels. Different safety modules can be integrated according to the requirements.
Double axis module	Single module is used to control two different axes. The double axis module is supplied via the DC link bus.
DC connection module	The DC connection module enables the connection of other components to the DC link of the COMBIVERT H6. This allows devices of other series or other manufacturers to be connected to the DC bus connection. The branch can optionally be protected with DC fuses. Triggering of the fuse(s) is monitored.
DC terminal	The DC terminal enables the branch via cables from the DC bus bars of the COMBIVERT H6. This allows devices of other series or other manufacturers to be connected to the DC bus connection. The DC terminal is a passive component and has no internal fuses in contrast to the DC connection module.

2.1 Specified application

The COMBIVERT H6 is a DC-coupled drive system for the control of different axes. It serves exclusively for the control and regulation of three-phase motors. It is intended for the installation into electrical systems or machines.

Technical data and information for connection conditions shall be taken from the name-plate and the instructions for use and must be strictly observed.

The used semiconductors and components of the KEB Automation KG are developed and dimensioned for the use in industrial products.

RESTRICTION

If the KEB COMBIVERT F5 is used in machines, which work under exceptional conditions or if essential functions, life-supporting measures or an extraordinary safety step must be fulfilled, the necessary reliability and security must be ensured by the machine builder.

Residual risks

Despite intended use, drive converters can reach unexpected operating conditions in case of error, with wrong parameterization, by faulty connection or unprofessional interventions and repairs. This can be:

- wrong direction of rotation
- motor speed too high
- motor is running into limitation
- motor can be under voltage even in standstill
- automatic start

2.2 Unintended use

The operation of other electric consumers is prohibited and can lead to the destruction of the unit. The operation of our products outside the indicated limit values of the technical data leads to the loss of any liability claims.

2.3 Product features

These instructions for use describe the following devices:

Device type:	Axis module
Series:	COMBIVERT H6
Power range:	0.75...110 kW / 400 V
Housing:	B, P, C, S, E, U, G, W

The COMBIVERT H6 is characterized by the following features:

- System bus EtherCAT Transmission of setpoint and actual values between control and drive modules.
- Error bus Channel 1: Error output of the connected DC buses. Channel 2: Charging status of the DC link bus.
- Diagnostic interface RS232/485 interface for the connection of displays or service tools.
- Inputs and outputs 4 digital inputs
4 digital outputs
- Internal fuses The driver/power unit is connected via internal fuses to the DC link bus.
- Drive profiles The drive modules contain a CanOpen compliant object directory according to CiA402.
- SCL and ASCL Operation of encoderless synchronous and asynchronous motors is supported.
- More functions Rotor position detection, high torque and speed accuracy.
- Encoder interfaces Multi-encoder system for different encoders can be integrated either in the drive module or in the control.
- Motor temperature Motor temperature detection occurs via a switchable PTC/KTY input.
- Brake control An output is available for direct control of a 24 V brake.
- Cooling system universally by flat rear and air heat sink

2.4 Type code

x x	H6	x	x	x-x	x	x	x
Reserved		0: Reserved					
Encoder interface		A: No encoder interface B: Two-channel multi encoder interface H: Two-channel encoder interface for HTL signals					
Software configuration		1...9: KEB default A...Z: Customer / special version					
Switching frequency; overload		1: 4 kHz; Overload in accordance with technical data 2: 4 kHz; Special overload behavior A...Z: Customer / special version (firmware and download)					
Housing		Flat rear heatsink B: 50 mm E: 200 mm C: 100 mm G: 300 mm Air heat sink P: 50 mm U: 200 mm S: 100 mm W: 300 mm					
Control type		A: KEB standard with control release and brake control type 0 B: KEB standard with safety module type 1 C: KEB standard with safety module type 2					
Axis module		A: Single-axis module B: Double axis module					
Series		COMBIVERT H6 multi-axis drive system					
Device size		07...25					

Table 1: Type code



The type code is not used as order code, it is only used for identification!

3 Technical Data

3.1 Operating conditions

3.1.1 Climatic environmental conditions

Storage		Standard	Class	Notes
Ambient temperature		EN 60721-3-1	1K4	-25...55 °C
Relative humidity		EN 60721-3-1	1K3	5...95 % (without condensation)
Storage height		–	–	Max. 3000 m above sea level
Transport		Standard	Class	Notes
Ambient temperature		EN 60721-3-2	2K3	-25...70 °C
Relative humidity		EN 60721-3-2	2K3	95 % at 40 °C (without condensation)
Operation		Standard	Class	Notes
Ambient temperature		EN 60721-3-3	3K3	5...40 °C (extended to -10...45 °C)
Coolant inlet temperature	Air	–	–	5...40 °C (-10...45 °C)
	Water	–	–	5...40 °C
Relative humidity		EN 60721-3-3	3K3	5...85 % (without condensation)
Version and degree of protection		EN 60529	IP20	Protection against foreign material > ø12.5 mm No protection against water Non-conductive pollution, occasional condensation when PDS is out of service.
Site altitude		–	–	Max. 2000 m above sea level <ul style="list-style-type: none"> With site altitudes over 1000 m a derating of 1 % per 100 m must be taken into consideration. With site altitudes over 2000 m, the control board to the mains has only basic isolation. Additional measures must be taken when wiring the control.

Table 2: Climatic environmental conditions

3.1.2 Mechanical environmental conditions

Storage	Standard	Class	Notes
Vibration limits	<i>EN 60721-3-1</i>	1M2	Vibration amplitude 1.5 mm (2...9Hz) Acceleration amplitude 5 m/s ² (9...200Hz)
Shock limit values	<i>EN 60721-3-1</i>	1M2	40 m/s ² ; 22 ms
Transport	Standard	Class	Notes
Vibration limits	<i>EN 60721-3-2</i>	2M1	Vibration amplitude 3.5 mm (2...9Hz) Acceleration amplitude 10 m/s ² (9...200 Hz) Acceleration amplitude 15 m/s ² (200...500Hz)
Shock limit values	<i>EN 60721-3-2</i>	2M1	100 m/s ² ; 11 ms
Operation	Standard	Class	Notes
Vibration limits	<i>EN 60721-3-3</i>	3M4	Vibration amplitude 3.5 mm (2...9Hz) Acceleration amplitude 10 m/s ² (9...200Hz)
	<i>EN 61800-5-1</i>	–	Vibration amplitude 0.075 mm (10...57 Hz) Acceleration amplitude 10 m/s ² (57...150Hz)
Shock limit values	<i>EN 60721-3-3</i>	3M4	100 m/s ² ; 11 ms
Pressure in the water cooler	–	–	Max. operating pressure: 10 bar

Table 3: Mechanical environmental conditions

3.1.3 Chemical / mechanical active substances

Storage	Standard	Class	Notes	
Contamination	<i>EN 60721-3-1</i>	Gases	1C2	–
		Solids	1S2	–
Transport	Standard	Class	Notes	
Contamination	<i>EN 60721-3-2</i>	Gases	2C2	–
		Solids	2S2	–
Operation	Standard	Class	Notes	
Contamination	<i>EN 60721-3-3</i>	Gases	3C2	–
		Solids	3S2	–

Table 4: Chemical / mechanical active substances

3.1.4 Electrical operating conditions

3.1.4.1 Device classification

Requirement	Standard	Class	Notes
Overvoltage category	EN 61800-5-1	III	–
	EN 60664-1		–
Pollution degree	EN 60664-1	2	Non-conductive pollution, occasional condensation when PDS is out of service.

Table 5: Device classification

3.1.4.2 Electromagnetic compatibility

The indicated values are only valid for units with external filter.

EMC emitted interference	Standard	Class	Notes
Conducted interference emission	EN 61800-3	C2	–
Radiated interferences	EN 61800-3	C2	–
Interference immunity	Standard	Level	Notes
Static discharges	EN 61000-4-2	8 kV 4 kV	AD (air discharge) CD (contact discharge)
Burst - Ports for process measurement control functions and signal interfaces	EN 61000-4-4	2 kV	–
Burst - Power ports	EN 61000-4-4	4 kV	–
Surge - Power ports	EN 61000-4-5	1 kV 2 kV	Phase-phase Phase-ground
Conducted immunity, induced by high-frequency fields	EN 61000-4-6	10 V	0.15...80 MHz
Electromagnetic fields	EN 61000-4-3	10 V/m 3 V/m 1 V/m	80 MHz...1 GHz 1.4...2 GHz 2...2.7 GHz
Voltage fluctuations/ voltage drops	EN 61000-2-1 EN 61000-4-34	–	-15 %...+10 % 90 %
Frequency changes	EN 61000-2-4	–	≤ 2 %
Voltage deviations	EN 61000-2-4	–	±10 %
Voltage unbalances	EN 61000-2-4	–	≤ 3 %

Table 6: Electromagnetic compatibility

3.2 Technical data of the axis modules

Module mode		Single axis						Double axis					
		07		10		12		07		10		12	
Device size		B	P	B	P	B	P	B	P	B	P	B	P
Rated output power	S_{out} / kVA	1.8	4	6.2		2.18	2 x 4	2 x 6.2					
Max. rated motor power	P_{mot} / kW	0.75	2.2	4		2 x 0.75	2 x 2.2	2 x 4					
Rated output current	I_{out} / A	2.6	5.8	9		2 x 2.6	2 x 5.8	2 x 9					
Short time current limit at 0Hz	I_{fo} / A	5.2	9	9		2 x 5.2	2 x 9	2 x 9					
Short time current limit	¹⁾ I_{max} / A	5.2	11.6	18		2 x 5.2	2 x 11.6	2 x 18					
Min. frequency at short time current limit	f_d / Hz	1	1	5		1	1	5					
Output voltage	U_{out_ac} / V	3-phase 0... $U_{in} / \sqrt{2}$											
Output frequency	f_{out} / Hz	recommended upto 1/10 of the switching frequency											
Switching frequency	f_s / kHz	4											
Power dissipation heat sink	P_{VK} / W	18	37	58		36	74	116					
Power dissipation interior	P_{VI} / W	18	22	26		26	34	42					
Max. heat sink temperature	$T_{HS} / \text{°C}$	80											
Motor cable cross-section	$\varnothing / \text{mm}^2$	1.5	1.5	2.5		2 x 1.5	2 x 1.5	2 x 2.5					
Max. motor cable length shielded	l / m	35											
Supply power unit													
Rated input voltage	U_{N_dc} / V	565											
Input voltage range	U_{in_dc} / V	452...840											
Supply control unit													
Rated input voltage	U_{N_dc} / V	24											
Input current	²⁾ I_{in_dc} / A	1											
Additional input current for air cooler	I_{dc} / A	0.15											

Table 7: Overview of the device data housing B, P

¹⁾ The overcurrent cut-off (E.OC) occurs approx. 20% over the short time current limit.

²⁾ Without external load by digital outputs, encoder, brake or fan.

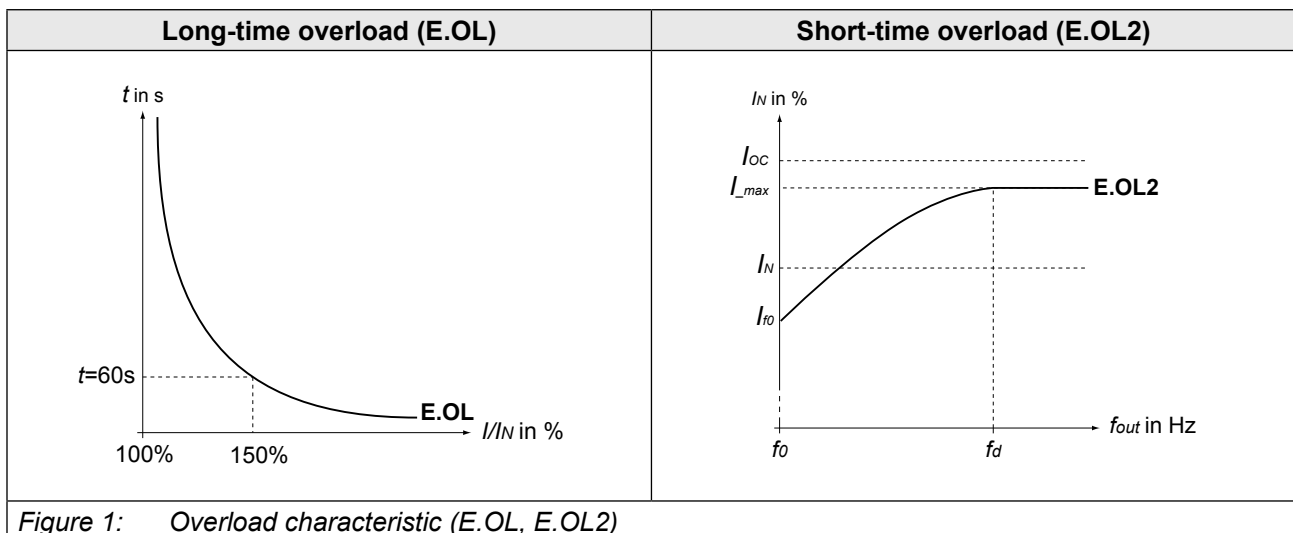

Figure 1: Overload characteristic (E.OL, E.OL2)

Module mode		Single axis											
		13		14		15		16		18		19	
Device size		C	S	C	S	C	S	C	S	C	S	C	S
Housing		C	S	C	S	C	S	C	S	C	S	C	S
Rated output power	S_{out} / kVA	8.3	11	17	23	33	42						
Max. rated motor power	P_{mot} / kW	5.5	7.5	11	15	22	30						
Rated output current	I_{out} / A	12	16.5	24	33	48	60						
Short time current limit at 0 Hz (for 60s)	¹⁾ I_{fo} / A	19	19	30	42	65	65						
Short time current limit (for 60s)	^{1) 2)} I_{max} / A	24	33	43.2	59	86	90						
Min. frequency at short time current limit	f_d / Hz	2	8	8	4	5	6						
Output voltage	U_{out_ac} / V	3-phase 0... $U_{in} / \sqrt{2}$											
Output frequency	f_{out} / Hz	recommended upto 1/10 of the switching frequency											
Switching frequency	f_s / kHz	4											
Power dissipation heat sink	P_{DK} / W	77	99	150	209	316	382						
Power dissipation interior	P_{DI} / W	31	39	47	61	72	79						
Max. heat sink temperature	T_{HS} / °C	80											
Motor cable cross-section	\varnothing / mm ²	4	4	6	10	25	25						
Max. motor cable length shielded	l / m	35											
Supply power unit													
Rated input voltage	U_{N_dc} / V	565											
Input voltage range	U_{in_dc} / V	452...840											
Supply control unit													
Rated input voltage	U_{N_dc} / V	24 (±10%)											
Input current	³⁾ I_{in_dc} / A	1											
Additional input current for air cooler	I_{dc} / A	0.5											

Table 8: Overview of the device data housing C, S

¹⁾ Restrictions:

- The thermal dimensioning of the heat sinks is based on the rated current and the maximum permissible ambient temperature. At high ambient temperatures and/or high heatsink temperatures (for example, due to a preceding utilization nearby 100%), the drive converter can change to over-temperature error before the protective function OL is triggered.
- At low output frequencies or switching frequencies higher than the rated switching frequency, the maximum current (10Hz/16Hz) can be exceeded before and error OL2 can be triggered, => „Figure 1: Overload characteristic (E.OL, E.OL2)“.

²⁾ The overcurrent cut-off (E.OC) occurs approx. 20% over the short time current limit.

³⁾ Without external load by digital outputs, encoder, brake or fan.

TECHNICAL DATA OF THE AXIS MODULES

Module mode		Single axis										
		20		21		22		23		24		25
Device size		E	U	E	U	E	U	E	G	W	G	
Rated output power	S_{out} / kVA	52	62	76	100	125	145					
Max. rated motor power	P_{mot} / kW	37	45	55	75	90	110					
Rated output current	I_{out} / A	75	90	110	145	180	210					
Short time current limit at 0 Hz (for 60s)	¹⁾ I_{fo} / A	87	120	120	180	180	250					
Short time current limit (for 60s)	¹⁾²⁾ I_{max} / A	135	162	198	218	270	315					
Min. frequency at short time current limit	f_d / Hz	8	3.5	10	2.5	6.5	5.5					
Output voltage	U_{out_ac} / V	3-phase 0... $U_{in} / \sqrt{2}$										
Output frequency	f_{out} / Hz	recommended upto 1/10 of the switching frequency										
Switching frequency	f_s / kHz	4										
Power dissipation heat sink	P_{VK} / W	522	641	802	1117	1341	1656					
Power dissipation interior	P_{VI} / W	85	89	119	165	149	165					
Max. heat sink temperature	$T_{HS} / \text{°C}$	80										
Motor cable cross-section	$\varnothing / \text{mm}^2$	35	50	50	95	95	95					
Max. motor cable length shielded	l / m	20					15					
Supply power unit												
Rated input voltage	U_{N_dc} / V	565										
Input voltage range	U_{in_dc} / V	452...840										
Supply control unit												
Rated input voltage	U_{N_dc} / V	24 ($\pm 10\%$)										
Input current	³⁾ I_{in_dc} / A	1										
Additional input current for air cooler	I_{dc} / A	2.4				-		3.6		-		

Table 9: Overview of the device data housing E, G, U, W

¹⁾ **Restrictions:**

- The thermal dimensioning of the heat sinks is based on the rated current and the maximum permissible ambient temperature. At high ambient temperatures and/or high heatsink temperatures (for example, due to a preceding utilization nearby 100%), the drive converter can change to over-temperature error before the protective function OL is triggered.
- At low output frequencies or switching frequencies higher than the rated switching frequency, the maximum current (10Hz/16Hz) can be exceeded before and error OL2 can be triggered, => „Figure 1: Overload characteristic (E.OL, E.OL2)“.

²⁾ The overcurrent cut-off (E.OC) occurs approx. 20% over the short time current limit.

³⁾ Without external load by digital outputs, encoder, brake or fan.

3.3 DC link capacities

H6 Axis modules			
Device size		Housing	Capacity (uF)
07	Single axis module	B / P	195
10		B / P	195
12		B / P	195
07	Double axis module	B / P	195
10		B / P	195
12		B / P	390
13	Single axis module	C/S	280
14		C/S	390
15		C/S	560
16		C/S	705
18		C/S	1020
19		C/S	1360
20	Single axis module	E / U	1650
21		E / U	1950
22		E / U	2350
23		E / U	3100
24	Single axis module	G/W	3900
25		G/W	4700

Table 10: DC link capacities

3.4 Mechanical installation

3.4.1 Control cabinet installation

Mounting distances	Dimension	Distance in mm	Distance in inch
	A	150	6
	B	100	4
	C	30	1.2
	D	0	0
	E	0	0
	F ¹⁾	50	2
	¹⁾ Distance to preceding elements in the control cabinet door.		

NOTICE

Alignment of the devices during installation

The DC connection between the modules is made via metal bridges.

- To ensure perfect installation, the horizontal and vertical displacement between the devices must be kept to a minimum.

CAUTION



Hot Surface

Heat sinks can reach temperatures, which can cause burns when touching.

- If in case of structural measures a direct contact cannot be avoided, a warning notice "hot surface" must be mounted at the machine.

If construction-conditioned the control cabinet cannot be without indoor ventilation, appropriate filters must avoid suction of foreign objects.

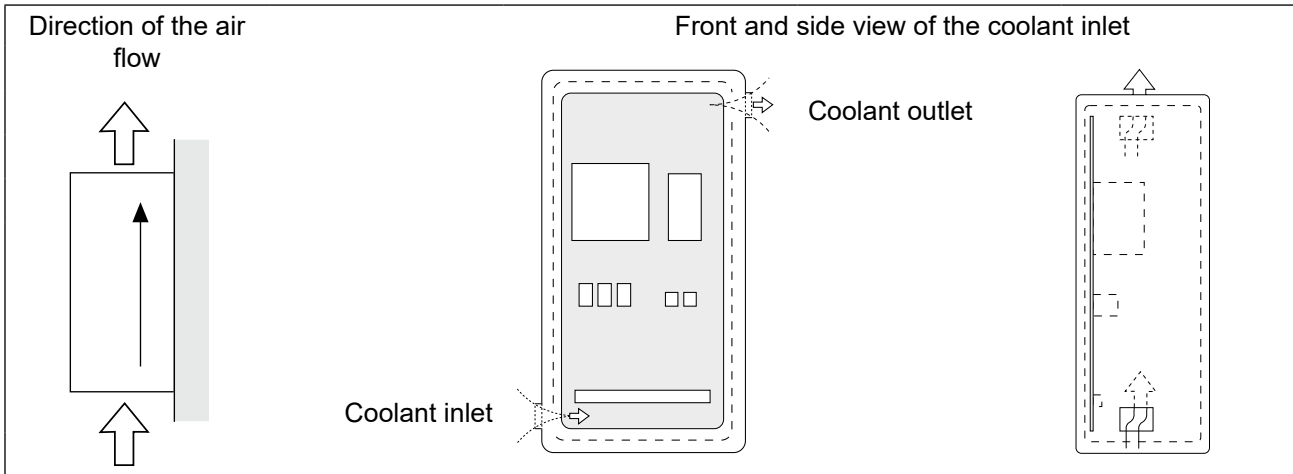

Figure 2: Control cabinet installation

**Assembly of the drive converter**

For reliable operation, the drive converter must be mounted without any clearance on a smooth, closed, bare metal mounting plate.

3.4.1.1 Mounting instructions for control cabinet installation

The following mounting materials with the appropriate quality must be used to assembly the drive converters.

Required material	Tightening torque
Socket screw ISO 4762 - M6x10 and M6x16 - 8.8	5 Nm 45 lb inch

Table 11: Mounting instructions for control cabinet installation

3.4.2 Installation instructions for flat rear heat sink

NOTICE**Overheating of the device.****Never operate flat rear devices without main cooler.**

- ▶ Select suitable cooling surfaces (e.g. water heat sink, ribbed heat sink, machine base).
- ▶ Screw the flat rear of the devices to the cooling surface.
- ▶ Ensure good thermal conductivity (e.g. thermal paste)
- ▶ The machine builder is responsible for the cooling of the units.

**Heat-conducting paste**

Information about the correct application of the heat-conducting paste are available at www.keb.de under the search term "*Heat-conducting paste*".

Select correct flow temperature for liquid coolers

- ▶ The flow temperature must be choose in such a way, that no moisture condensation occurs.

3.4.3 Dimensions central heat sink

3.4.3.1 Air heat sink



Central heat sink for air-cooling upon request.

3.4.3.2 Liquid heat sinks

Following liquid heat sinks are available, if no usable cooling surface exists at customer side:

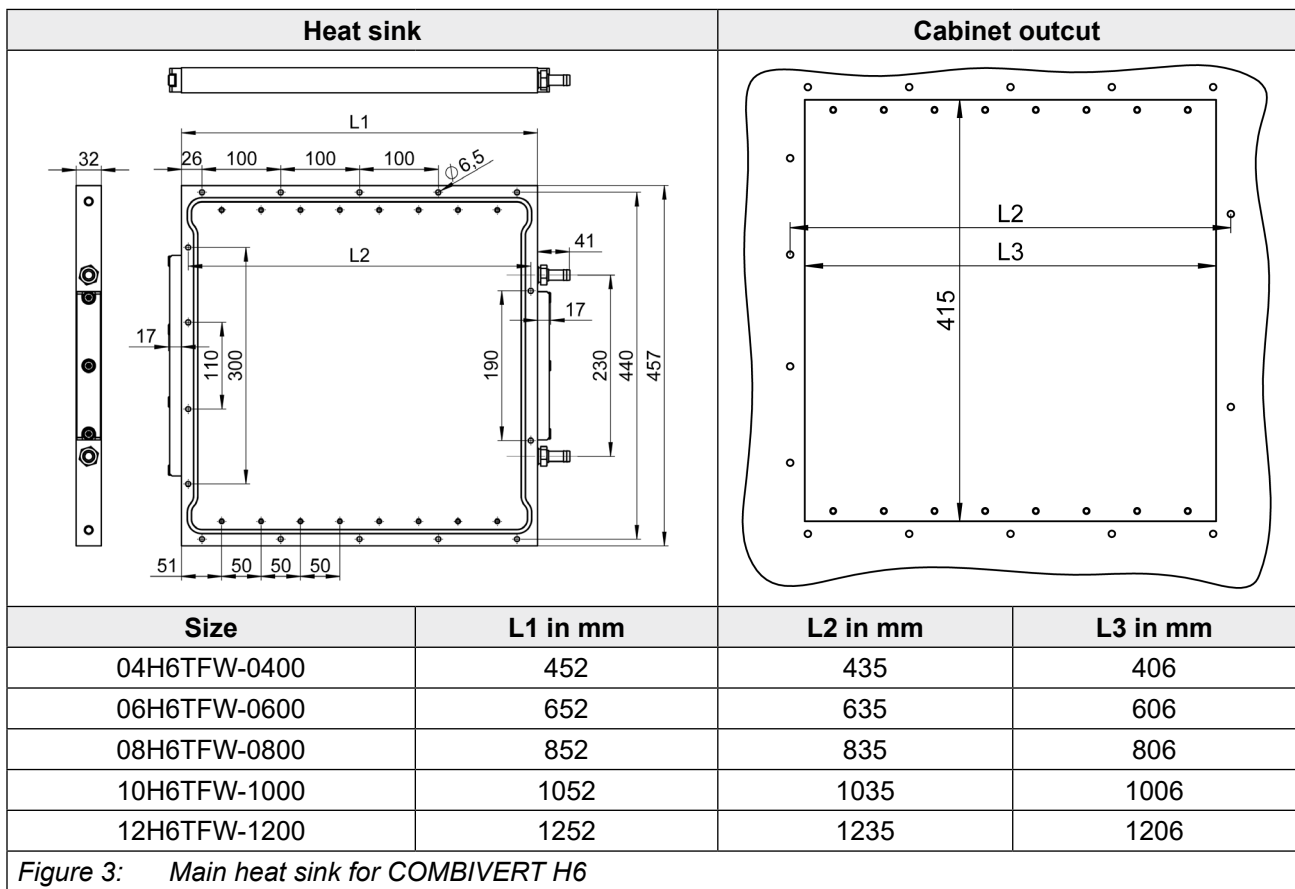

3.4.4 Dimensions and weights of modules with flat rear heat sink

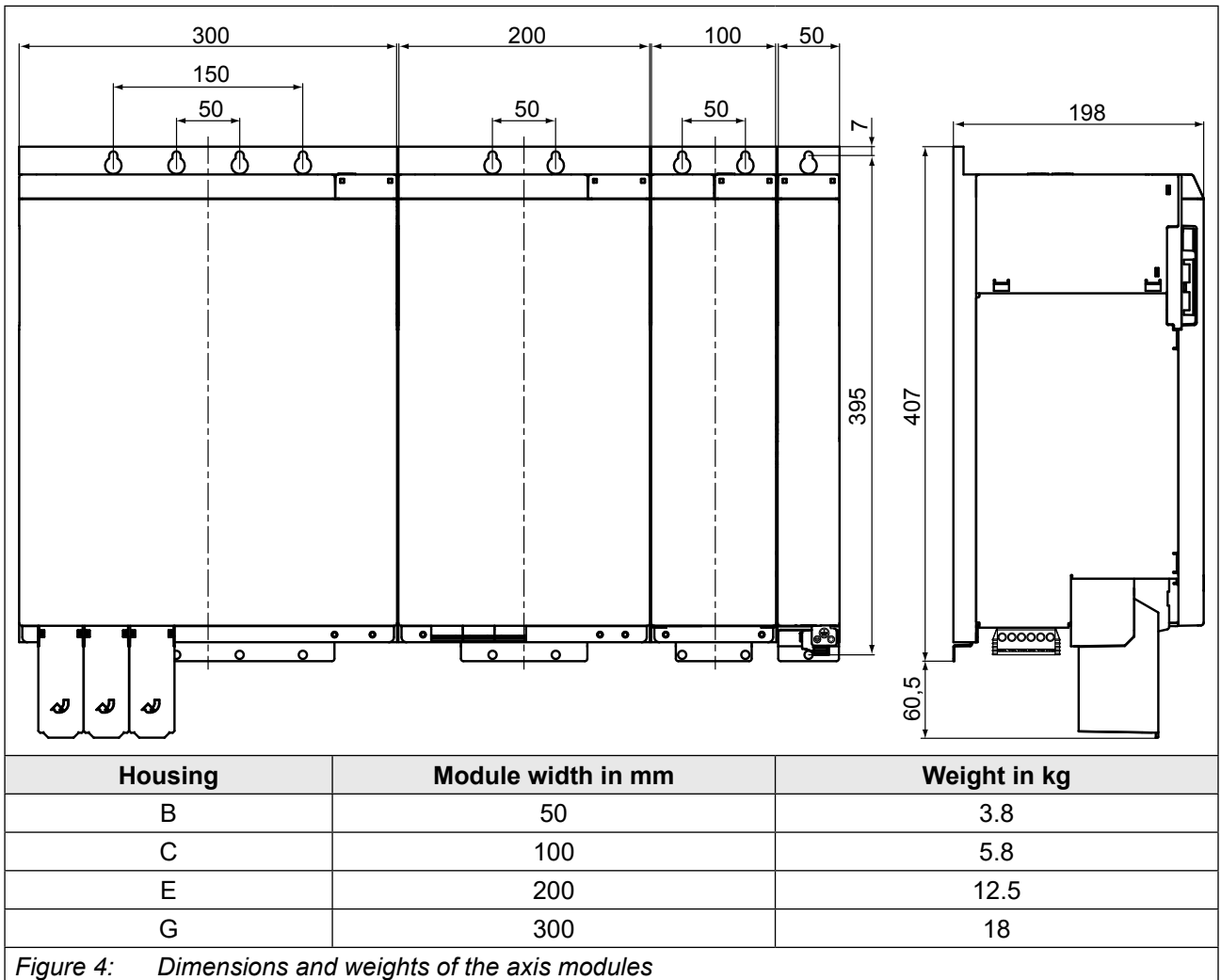

3.4.5 Dimensions of modules with air-cooled heat sink

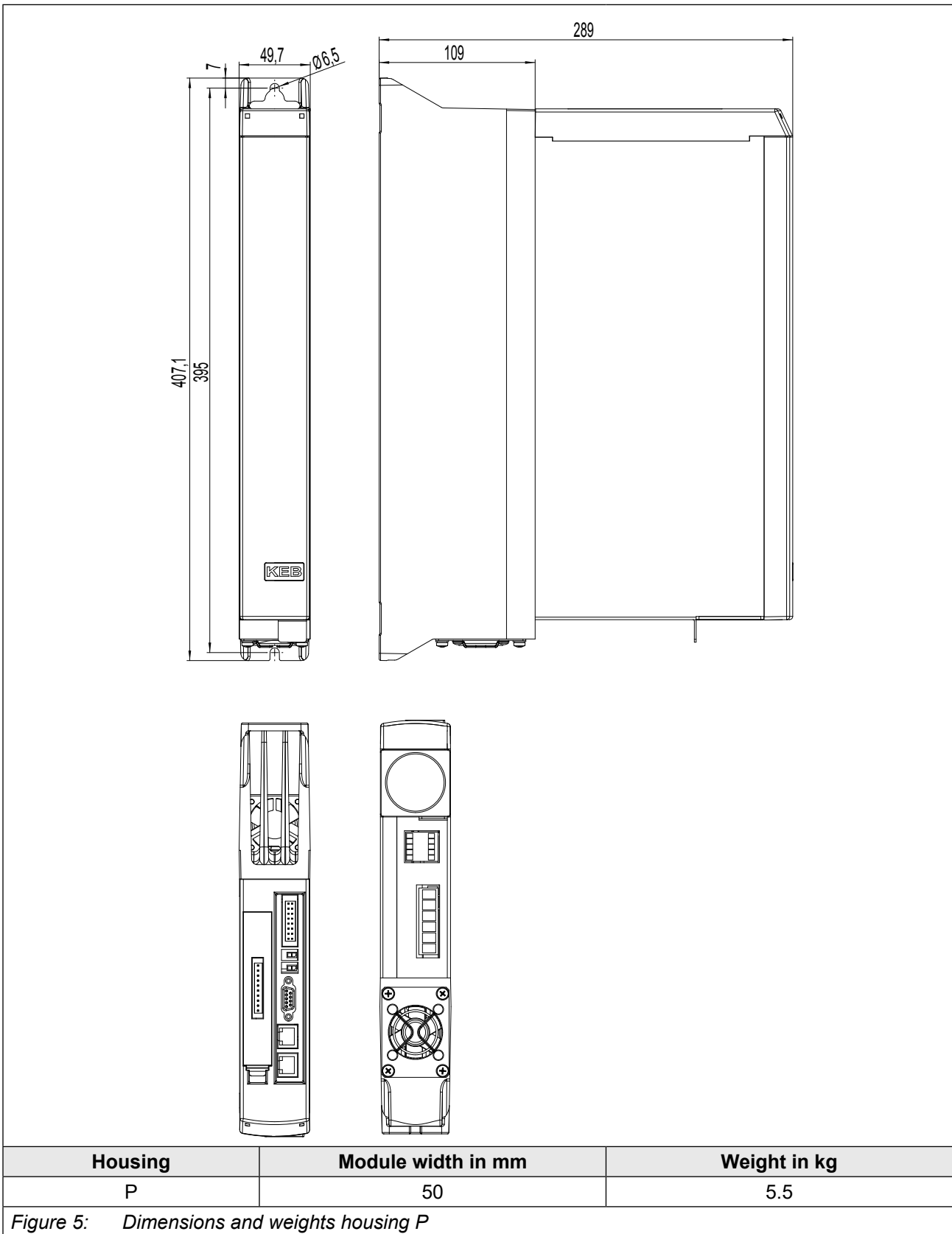

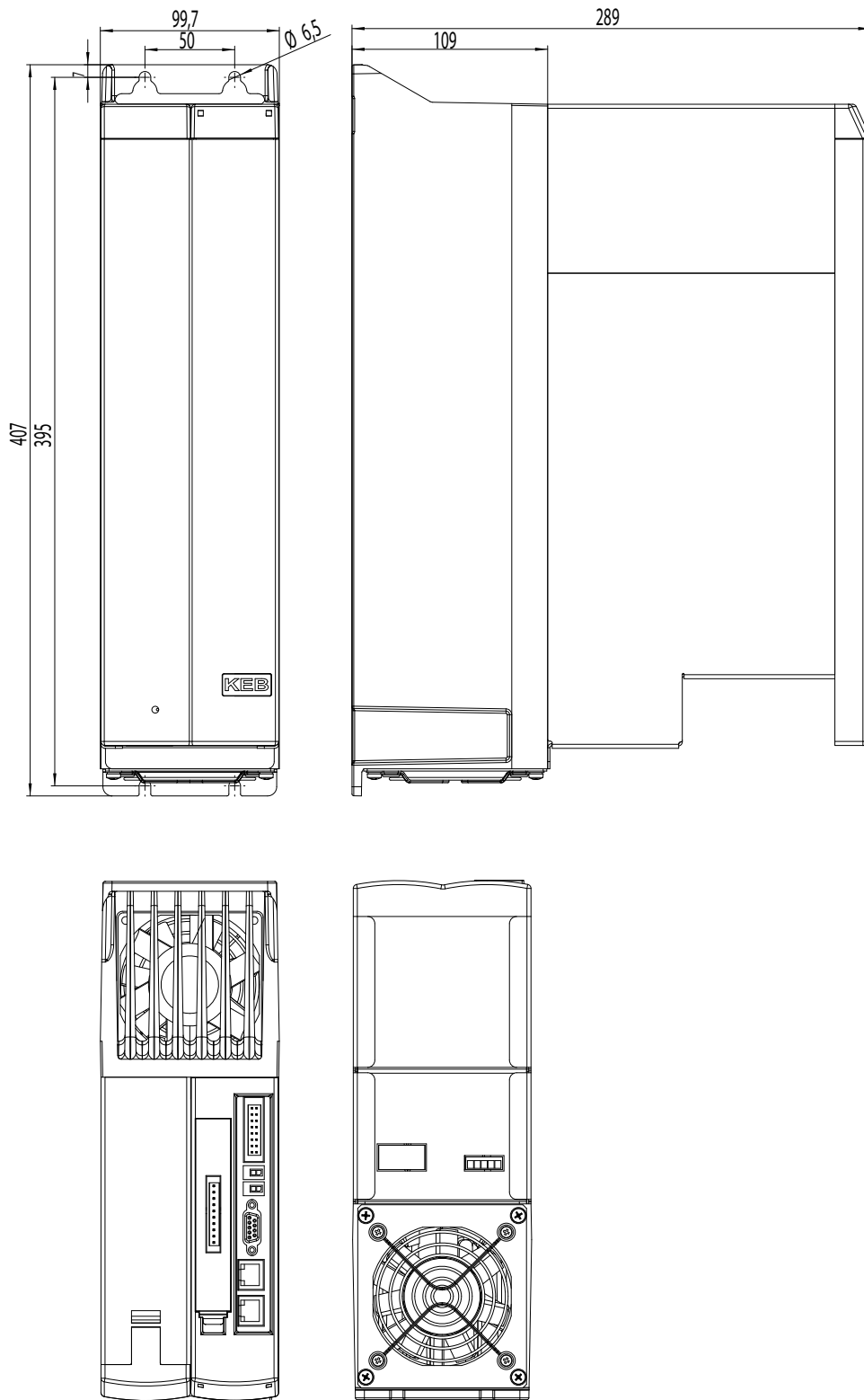

Housing	Module width in mm	Weight in kg
S	100	10

Figure 6: Dimensions and weights housing S

MECHANICAL INSTALLATION

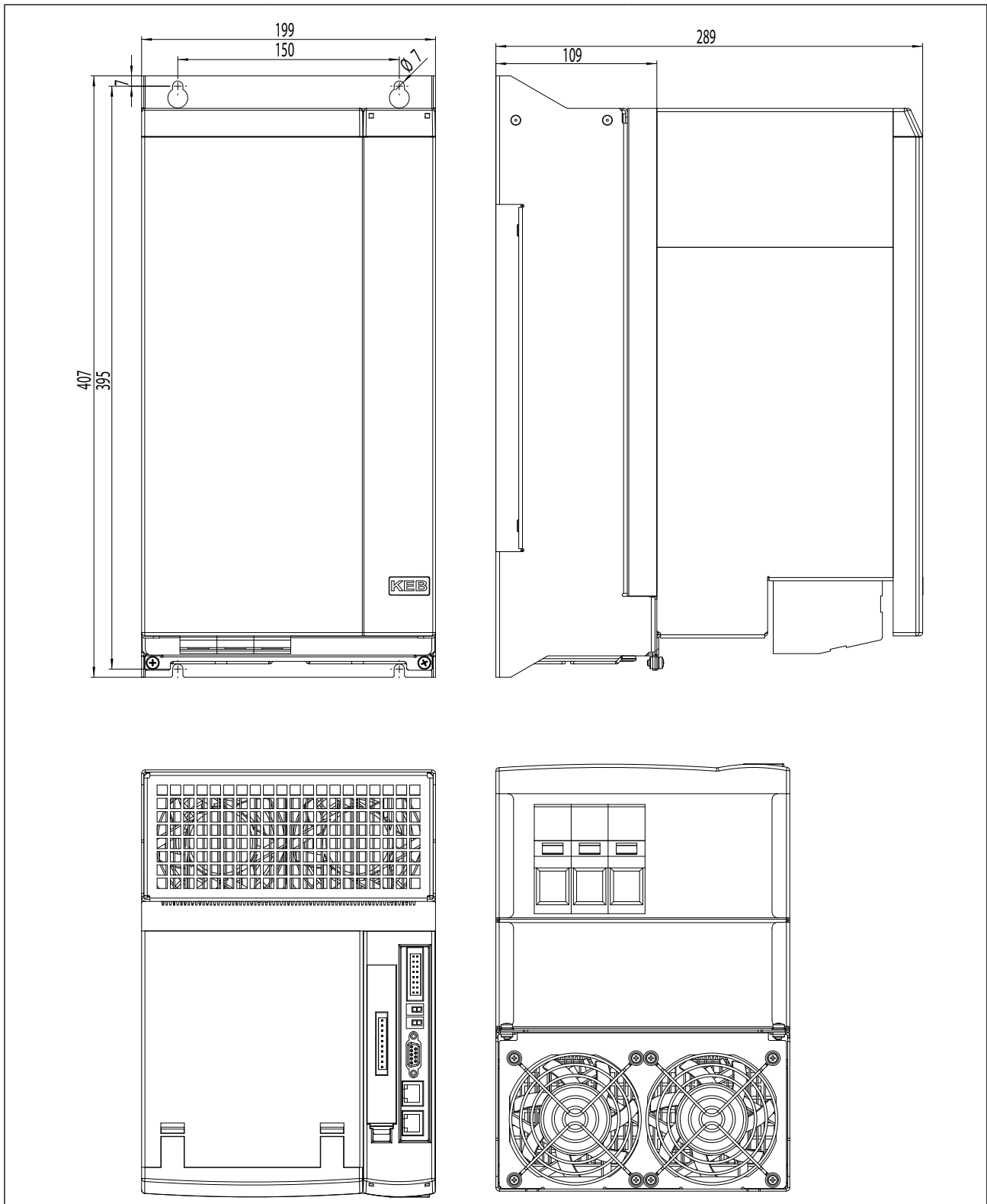

Housing	Module width in mm	Weight in kg
U	200	17

Figure 7: Dimensions and weights housing U

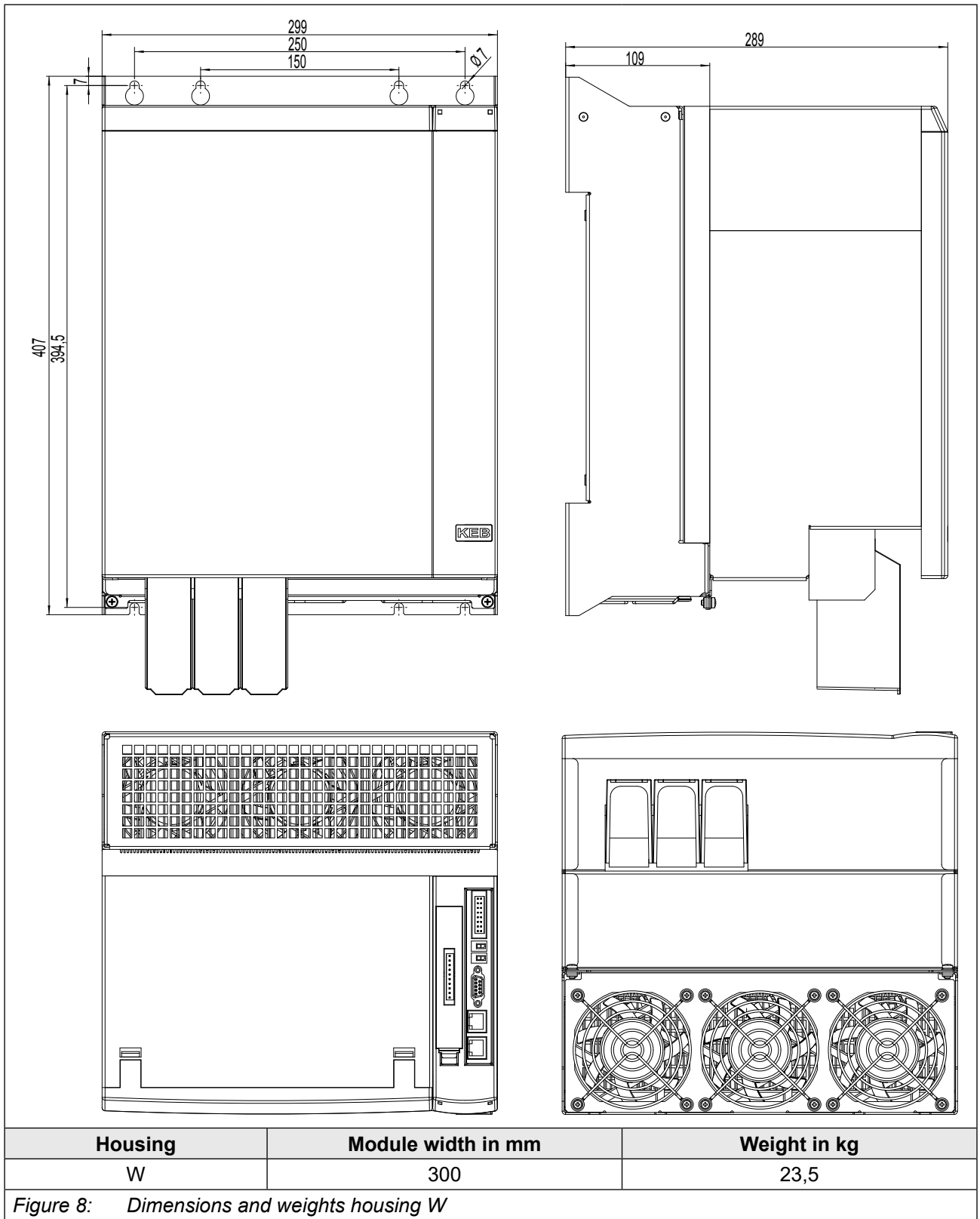

4 Installation and Connection

4.1 Construction of the device

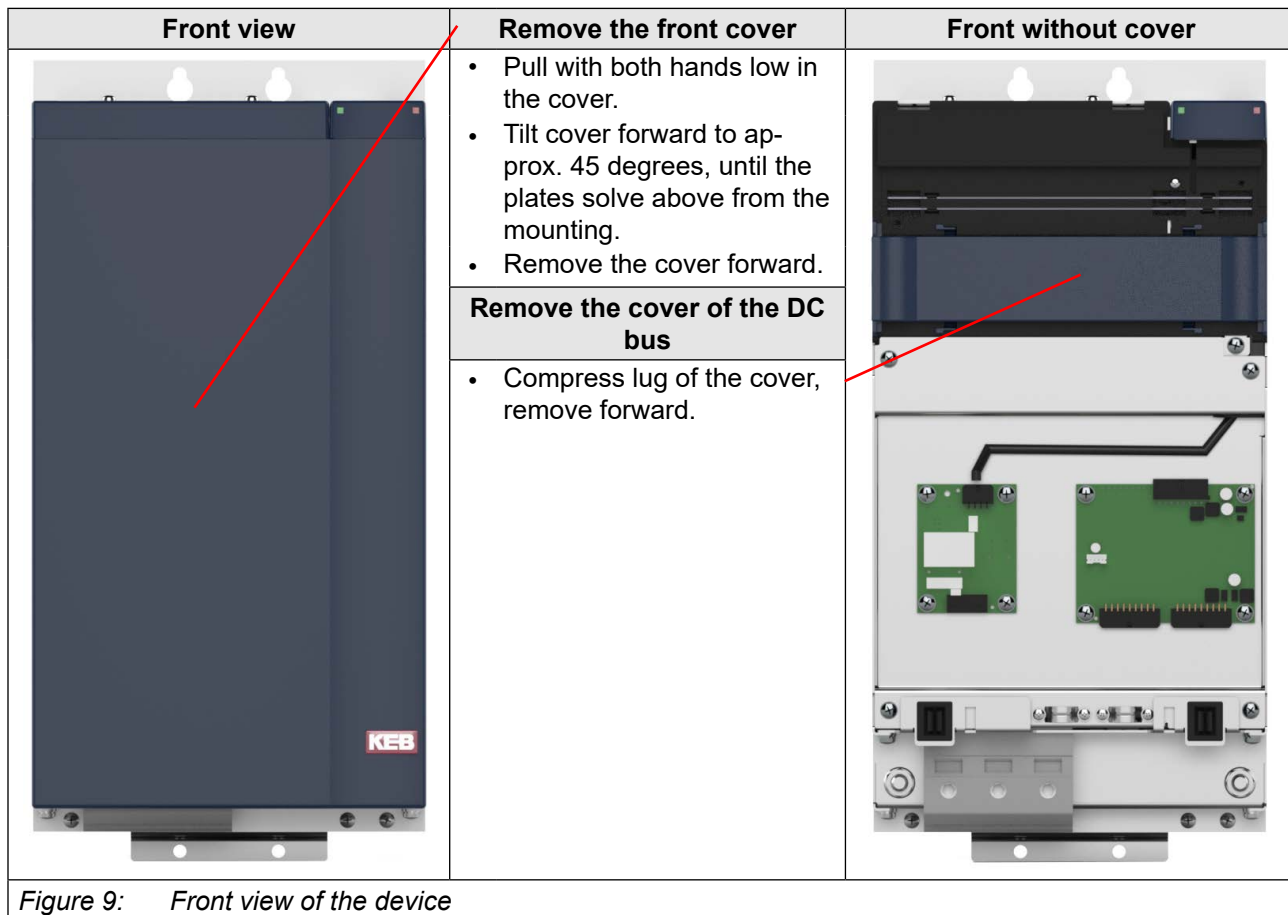

⚠ DANGER

Hazardous voltage under the cover of the DC bus

- ▶ Secure isolation from supply of the DC bus at the power supply and regenerative unit!

Description	Terminal	Connections of the front side	Terminal	Description
+24V bus	X1C.1		X1C.3	+24V bus
0V	X1C.2		X1C.4	0V
DC bus +	X1D.1		X1D.3	DC bus (displayed with protection against contact for exterior devices)
DC bus -	X1D.2		X1D.4	
Motor temperature and brake control (for housing B/C on the bottom side)	X1B		X3AB	Encoder input B
Encoder input A	X3AA		Snap-in for front cover	
Motor terminal block	X1A		Shielding clamp for encoder feedback, motor temperature and brake control	

Figure 10: Connections of the front side



View rear side of the device				
Housing B/P				
Single axis module		Double axis module		
				
X1A	Motor terminal block		X1A	
	U	Connection for three-phase motor! Connect in phase for correct direction of rotation. □		U-A
	V			V-A
W	W-A			
			U-B	
			V-B	
			W-B	
X1B	Option terminal block		X1BA	
	T1	Connection for PTC/KTY motor temperature monitoring		T1A
	T2			T2A
	B+	Connection for 24V DC brake		BB+
B-	BB-			
			Option terminal block motor B	
		X1BB	T1B	
			T2B	
			BB+	
			BB-	

Figure 11: View rear side of the device housing B/P

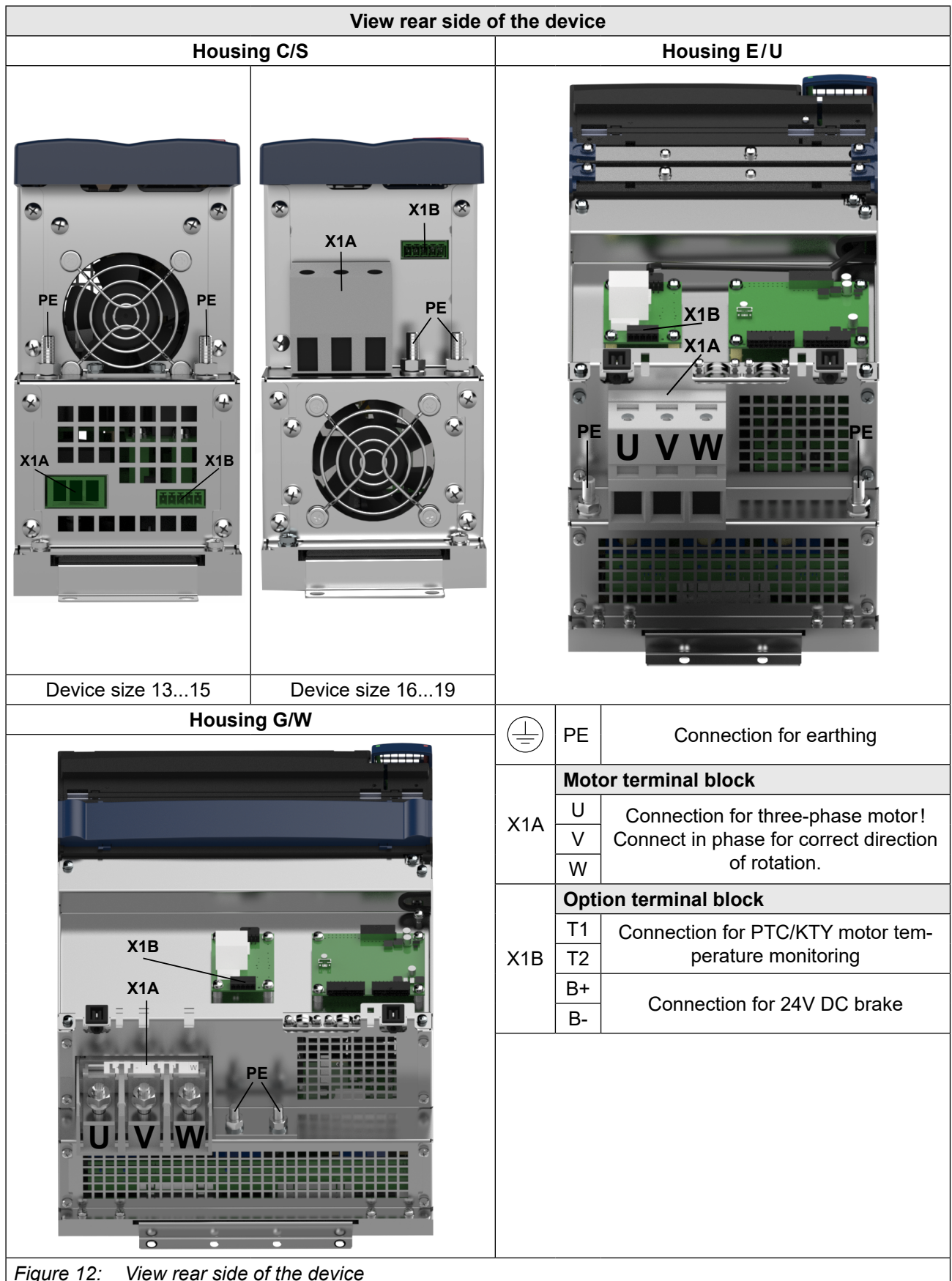

Figure 12: View rear side of the device

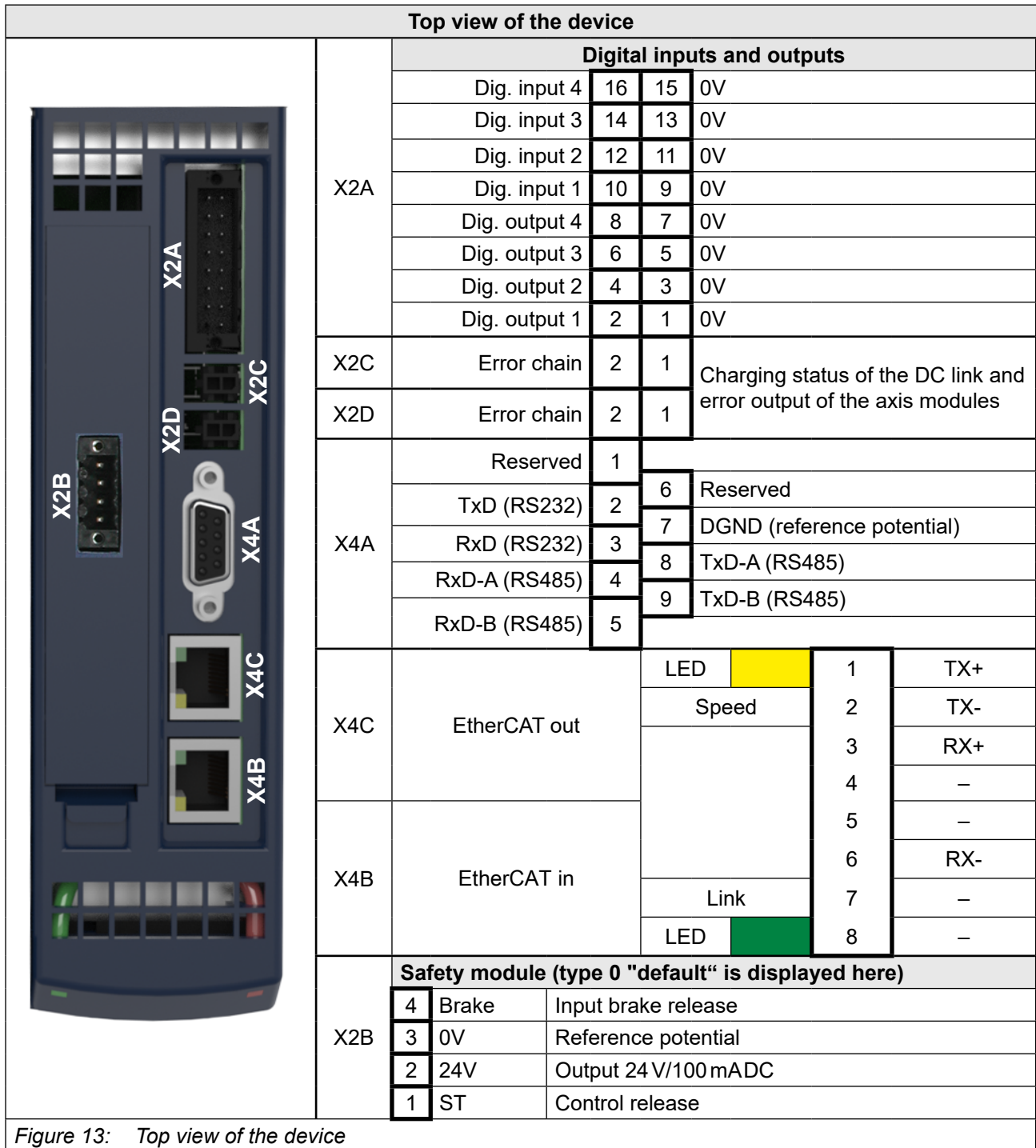

Figure 13: Top view of the device

4.1.1 Status LEDs



Figure 14: Status LEDs

4.1.1.1 Status-LED safety module

LED	Status
off	No voltage supply of the safety module
green	Safety module ready for operation
red	Safety module in error routine

Table 12: Status-LED safety module

4.1.1.2 Status LED axis module

LED	Status
off	No voltage supply of the device
yellow	Device initialised
green	Device ready for operation
red	Device in error routine

Table 13: Status LED axis module

4.2 Connection of the power unit

4.2.1 Connection of the DC bus X1D

The tinned copper bars connect the DC bus of the different H6 devices. Precharging, power supply and regeneration (if required) is provided by the power supply module. The electrical connection is made with metal bridges, which must be mounted (as illustrated in the photo). A plastic cap must be installed at both ends of the H6 system as protection against accidental contact.



If the DC current is greater than 350A, the current must be limited to this value for each DC bus connection X1D and the total current must be divided between the right and left connection.

⚠ DANGER

Dangerous voltage

- ▶ The voltage on the DC bus during operation can be up to DC 840 V!

Bridges for the connection of the DC bus between the devices	upper rail = DC+ lower rail = DC-	Place plastic cap as protection against accidental contact at the end of the system
Torx-oval-head screw M4x10	required tool Torx screw driver TX20	Tightening torque 3.0Nm (bridge) 1.1...1.2Nm (plastic cap)
<p><i>Figure 15: Connection of the DC bus</i></p> <p>Attach the cover for the DC bus again after the installation.</p>		

4.2.2 Connection of the 24V bus X1C

The 24V bus supplies the control and the driver circuit of the axis module and the power supply and regenerative unit with 24VDC voltage. Generally this voltage is provided by the COMBIVERT H6 power supply module, but also an existing voltage source can be used.



	The bridge for the connection of the 24V bus is attached to the devices and fixed with a screw.	
	Cross-head screw M3x10	Tightening torque 0.5 Nm
<p><i>Figure 16: Connection of the 24V bus</i></p>		

NOTICE



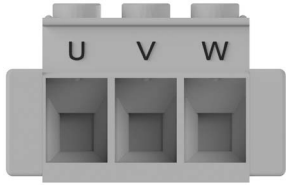
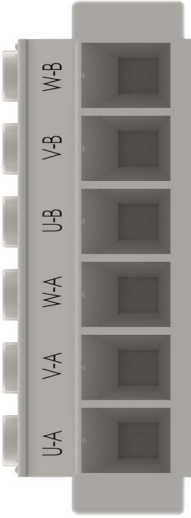

The assembly of the jumper must be carried out with special care. Tilting or breaking the plug contacts is to be prevented.



4.2.3 Connection of the motor

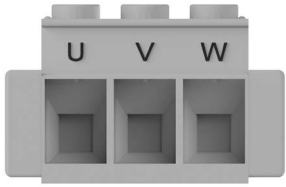

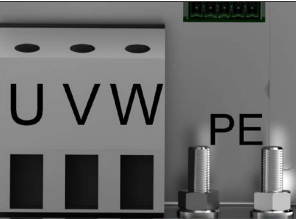
4.2.3.1 Motor terminal X1A

Housing B/P Single axis module	Name	Function	Cross-section	Tightening torque
	U, V, W	Motor connection	0.2...6 mm ² AWG 24-10	0.7 Nm 6.2lb inch
Housing B/P Double axis module	Name	Function	Cross-section	Tightening torque
	U-A, V-A, W-A	Motor connection A	0.2...6 mm ² AWG 24-10	0.7 Nm 6.2lb inch
	U-B, V-B, W-B	Motor connection B	0.2...6 mm ² AWG 24-10	0.7 Nm 6.2lb inch
	PE, 	Connection for shield- ing/ earthing	Screw M4 for ring crimp connector	1.3 Nm 11.5lb inch
Required tool		Screw driver		
<i>Figure 17: Housing B/P motor connection</i>				

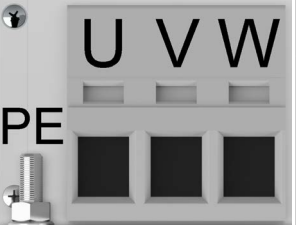
CONNECTION OF THE POWER UNIT

Housing C/S	Name	Function	Cross-section	Tightening torque
Device size 13...15				
	U, V, W	Motor connection	0.2...6 mm ² AWG 24-10	0.7 Nm 6.2 lb inch
	PE, 	Connection for shielding/ earthing	M6 stud for ring crimp connector	5 Nm 44 lb inch
Device size 16...19				
	U, V, W	Motor connection	6..35 mm ² AWG 8-2	4...4.5 Nm 35.4...39.8 lb inch
	PE, 	Connection for shielding/ earthing	M6 stud for ring crimp connector	5 Nm 44 lb inch
Required tool		Screw driver		
<i>Figure 18: Housing C/S motor connection</i>				

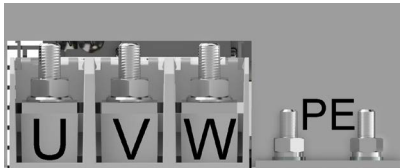
Housing E/U	Name	Function	Cross-section	Tightening torque
	U, V, W	Motor connection	35...95 mm ² AWG 4-kcmil 250	15 Nm 132 lb inch
	PE, 	Connection for shielding/ earthing	M8 stud for ring crimp connector	12 Nm 110 lb inch
Required tool		Screw driver		
<i>Figure 19: Housing E/U motor connection</i>				

Housing G/W	Name	Function	Cross-section	Tightening torque
	U, V, W	Motor connection	M10 stud for ring crimp connector	30 Nm 265,5 lb inch
	PE, 	Connection for shielding/ earth- ing	M8 stud for ring crimp connector	12 Nm 110 lb inch
Required tool		Screw driver		
<i>Figure 20: Housing G/W motor connection</i>				

4.2.3.2 Selection of the motor cable

Correct selection and wiring of the motor cable is very important for high motor ratings:

- Lower abrasion of the motor bearings by leakage currents
- Improved EMC characteristics
- Lower symmetrical operating capacities
- Less losses by equalizing currents

4.2.3.3 Interconnection of the motor

As a standard the connection of the motor must be carried out in accordance with the following table:

Connection of the motor	
230 / 400 V motor	400 / 690 V motor
400 V	400 V
Star	Delta

Figure 21: Interconnection of the motor

NOTICE

Incorrect behaviour of the motor!

The connection instructions of the motor manufacturer are generally valid!

CAUTION

Protect motor against voltage peaks!

Drive controllers switch with dv/dt of approx. $5kV/\mu s$ at the output. Voltage peaks can be caused by reflections which endanger the insulation of the motor with motor cable lengths (>15 m). A reduction of the voltage peaks to protect the motor can be reached by using a motor choke, a du/dt filter or a sine-wave filter.

CONNECTION OF THE POWER UNIT

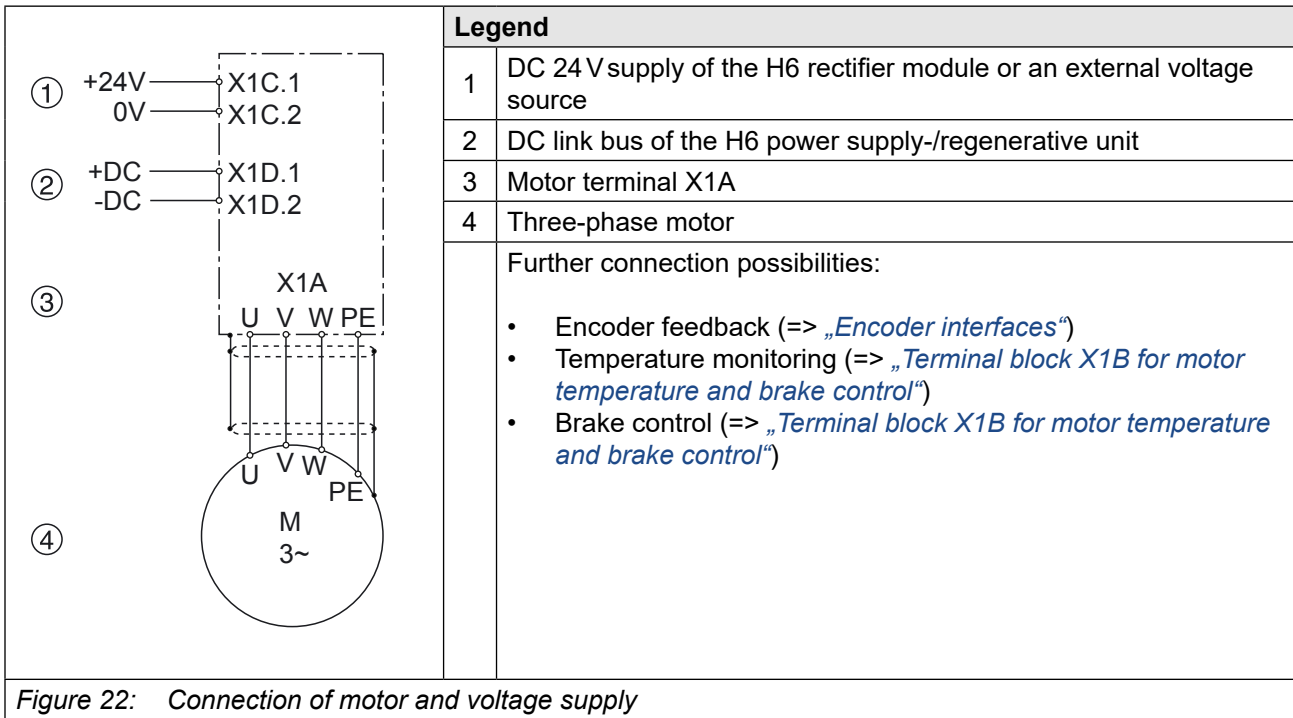

Figure 22: Connection of motor and voltage supply

4.2.3.4 Terminal block X1B for motor temperature and brake control

X1B	Name	Function	Cross-section	Tightening torque	
	T1, T2	Monitoring of the motor temperature	0.25...1.5 mm ² AWG 28-16	0.25 Nm 2.2 lb inch	
	B+, B-	Control of a brake			
X1BA		Name			Function
	T1A, T2A	Monitoring of the temperature at motor A			
	BA+, BA-	Control of a brake at motor A			
X1BB		Name			Function
	T1B, T2B	Monitoring of the temperature at motor B			
	BB+, BB-	Control of a brake at motor B			

Figure 23: Terminal block X1B

4.2.3.5 Motor temperature detection



Terminals T1, T2 at single axis module
 Terminals T1A,T2A, T1B, T2B at double axis module

NOTICE

KTY or PTC cable

- Do not lay KTY or PTC cable of the motor (even shielded) together with control cable!
- KTY or PTC cable inside the motor cable only permissible with double shielding!
- The input is base insulated.

The KEB COMBIVERT H6 is delivered with switchable KTY84/PTC evaluation. The desired function is set with dr33 and works in the following table:

dr33	Function of T1, T2	Resistance	Display ru28	Error/Warning
0	KTY84 (standard)	< 215 Ω	Error	2)
		498 Ω	1°C	1) 2)
		1 kΩ	100°C	1) 2)
		1.722 kΩ	200°C	1) 2)
		> 1811 Ω	Error	2)
1	PTC (in accordance with <i>EN 60947-8</i>)	< 750 Ω	T1-T2 closed	–
		0.75...1.65 kΩ (reset resistance)	undefined	–
		1.65...4 kΩ (tripping resistance)	undefined	–
		> 4 kΩ	T1-T2 open	2)

Table 14: Motor temperature detection

1) The warning level is adjusted with pn11. The error level is adjusted with pn14.
 2) The behavior of the drive controller in error/warning case is set with parameter pn12.

4.2.3.6 Use of the temperature input in KTY mode

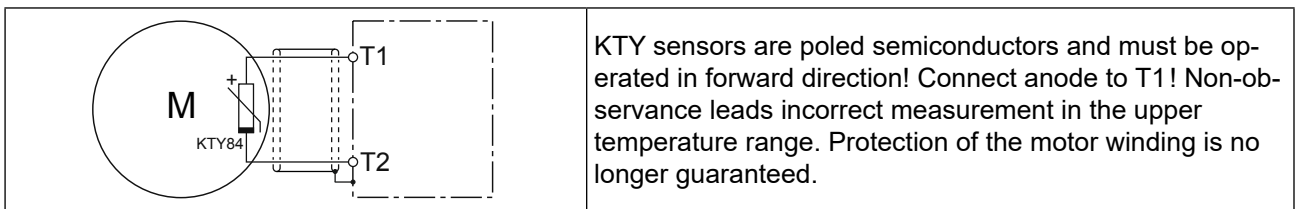

Figure 24: Connection of a KTY sensor

NOTICE

Wrong measurements!

- ▶ KTY sensors may not be combined with other devices.

CONNECTION OF THE POWER UNIT

4.2.3.7 Use of the temperature input in PTC mode

If the temperature input is operated in the PTC mode, the user can provide all possibilities within the resistance range specified in chapter "Motor temperature detection". This can be:

Thermal contact (NC contact)	
Temperature sensor (PTC)	
Mixed sensor chain	

Table 15: Wiring example in PTC mode



If no evaluation of the input is desired, a bridge between T1 and T2 pn12 can be installed or the error message can be ignored with pn12.

4.2.3.8 Brake control terminals B+, B-

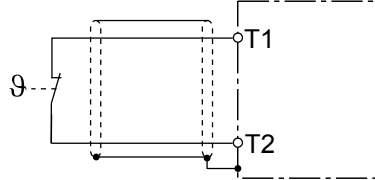
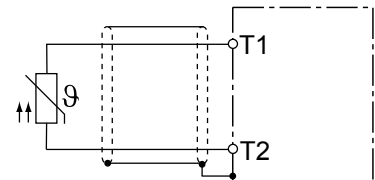
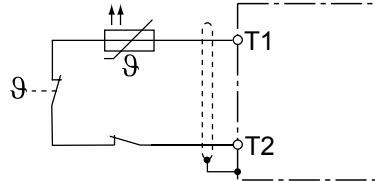
Terminal block X1B	Name	Description
	B+ B-	DC 24 V / max. 3.3A output for direct control of a brake. The max. current is depending on the number of axes and the rectifier module.

Figure 25: Brake control terminals B+, B-

4.2.3.9 Brake control terminals BA+, BA- and BB+, BB-

Terminal block X1B	Name	Description
	BA+ / BB+ BA- / BB-	DC 24 V / max. 2A output for direct control of a brake. The max. current is depending on the number of axes and the rectifier module.

Figure 26: Brake control terminals BA+, BA- and BB+, BB-

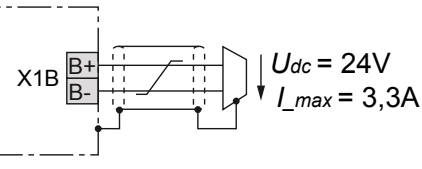
4.2.4 Encoder interfaces

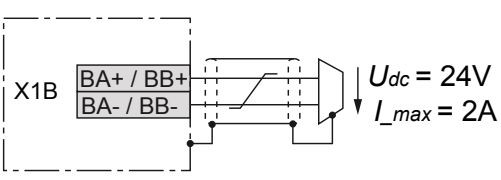
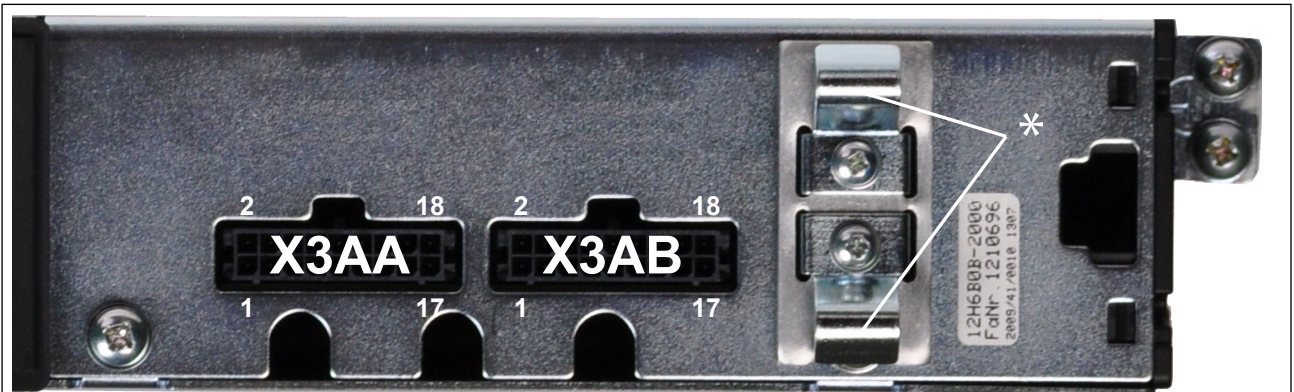

Figure 27: Encoder interfaces of housings B/P

* The shield of the encoder cables must be applied to these clamps at housing B/P.

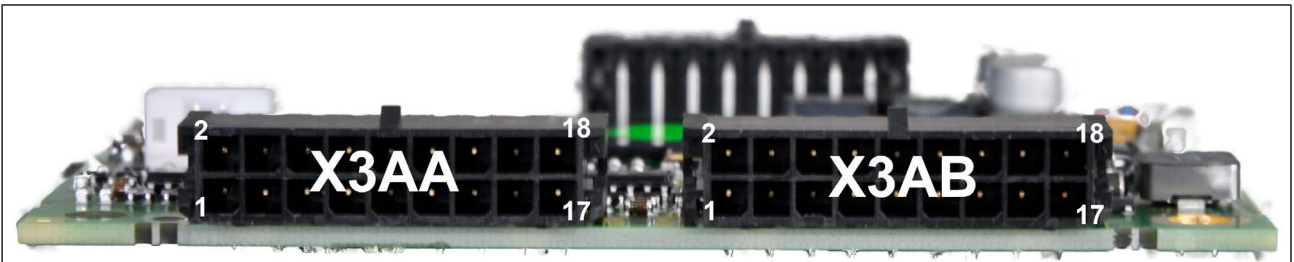

Figure 28: Encoder interfaces of housings C/S, E/U and G/W

4.2.4.1 Encoder interface X3AA (channel 1)

The integrated encoder interface X3AA is designed for different encoders. The encoder interface is defined by parameter Ec16. The following table contains the possible encoders and the appropriate signal assignment of the plug connector.

		17	15	13	11	9	7	5	3	1
		18	16	14	12	10	8	6	4	2
Encoder Pin	Inc-TTL	Resolver	Hiperface	SinCos	Endat +1Vss	Sin/Cos- SSI	Endat digital	BISS		
1	A+		Cos+	Cos+	Cos+	Cos+				
2	A-		Cos-	Cos-	Cos-	Cos-				
3	B+		Sin+	Sin+	Sin+	Sin+				
4	B-		Sin-	Sin-	Sin-	Sin-				
5	N+		Data+	N+	Data+	Data+	Data+	Data+	Data+	Data+
6	N-		Data-	N-	Data-	Data-	Data-	Data-	Data-	Data-
7		Cos+		Cos_abs+	Clock-	Clock-	Clock-	Clock-	Clock-	Clock-
8		Cos-		Cos_abs-						
9		Sin+		Sin_abs+	Clock+	Clock+	Clock+	Clock+	Clock+	Clock+
10		Sin-		Sin_abs-						
11		Exciter+								
12		Exciter-								
13	COM	COM	COM	COM	COM	COM	COM	COM	COM	COM
14	COM	Internal shielding	COM	COM	COM	COM	COM	COM	COM	COM
15	8V		8V	8V	8V	8V	8V	8V	8V	8V
16	5.25V		5.25V	5.25V	5.25V	5.25V	5.25V	5.25V	5.25V	5.25V
17	24V		24V	24V	24V	24V	24V	24V	24V	24V
18	COM		COM	COM	COM	COM	COM	COM	COM	COM
Shielding	open with heat-shrinkable tube and wire-end ferrule									

Figure 29: Encoder interface X3AA (channel 1)

NOTICE

Do not plug on/remove encoder cable during operation

To avoid undefined states do not plug on/remove the encoder cable during operation.

4.2.4.2 Encoder interface X3AA (channel 1) for HTL signals

The integrated encoder interface X3AA is designed for HTL signals. The encoder interface is defined by parameter Ec16. The following table contains the possible encoders and the appropriate signal assignment of the plug connector.

			17	15	13	11	9	7	5	3	1
			18	16	14	12	10	8	6	4	2
Encoder Pin	Ink-HTL	Resolver									
1	A_HTL+										
2	A_HTL-										
3	B_HTL+										
4	B_HTL-										
5	N_HTL+										
6	N_HTL-										
7		Cos+									
8		Cos-									
9		Sin+									
10		Sin-									
11		Exciter+									
12		Exciter-									
13	COM	COM									
14	COM	Internal shielding									
15	8V										
16	5.25V										
17	24V										
18	COM										
Shielding	open with heat-shrinkable tube and wire-end ferrule										

Figure 30: Encoder interface X3AA (channel 1) for HTL signals

NOTICE

Do not plug on/remove encoder cable during operation

To avoid undefined states do not plug on/remove the encoder cable during operation.

4.2.4.3 Encoder interface X3AB (channel 2)

The integrated encoder interface X3B is identical with the hardware of X3AA. At double axis modules it evaluates the second channel. The function (if assembled) is defined for single axis modules by software.

The following limitations are valid when operating with two encoders:

- The supply voltages 5V and 8V are generated with **one** programmable voltage source. Only encoders with 5V **or** 8V supply are possible (e.g. BiSS and HIPERFACE are not possible).
- There is only one Endat core on the encoder interface, therefore operation of a digital EnDat 2.2 encoder together with a EnDat analog encoder is not possible.

4.2.4.4 Description of the encoder interfaces

Pin	Signals	Description
1, 2, 3, 4	A+/-, B+/-, Cos+/-, Sin+/-	Input for sinusoidal incremental signals with 1Vss (0.6...1.2 Vss) or square-wave incremental signals to RS485 200 kHz at 0A. H6.220-0018 cards, 300kHz at 0AH6220-0038 cards RS485: 300kHz The maximum frequencies apply to ideal 1Vss signals. Deviations and differences in amplitude, phase shifting or DC component lead to a reduction of the maximum evaluable signal frequencies.
1, 2, 3, 4, 5, 6	A_HTL +/-, B_HTL +/-, N_HTL+/-	Only for devices with HTL encoder! Input for HTL incremental signals and zero signal 10V to 30V, max. 100 kHz
5, 6	N+/-	Input zero signal either 1Vss or RS485
	Data+/-	Input or output for data signal RS485
7, 8, 9, 10	Sin+/-, Cos+/-, Sin_abs+/, Cos_abs+/-	Input for sinusoidal absolute signals either 1Vss for SinCos encoder or max. 3.8Vss for resolver
7, 9	Clock+/-	Output for clock signal RS485
11, 12	Exciter+/-	Output field voltage for resolver: 7.2Vss +/- 5% , max. 30mAeff, 10.15kHz Coupling factor for resolver: 0.5 Phase shifting 0°
15	8V	Output supply voltage for encoder: 8V, +/- 5%, max. 500mA. If 5V are set in ec.14, the output voltage of pin 15 is 5.25V!
16	5.25V	Output supply voltage for encoder: 5.25V, +/- 5%, max. 500mA. Depending on the load the voltage can additionally drop by further 5%. If 8V are set in ec.14, the output voltage of pin 16 is 0V!
17	24V	Output supply voltage for encoder: Connection to the 24V DC bus. Max. 400mA resp. depending on 24V supply.

Table 16: Description of the encoder interfaces



Maximum current data apply to both encoder interfaces together.

4.3 Connection of the control

4.3.1 Error chain terminal X2C, X2D



Channel		Name	Description	Connecting cable error chain										
2	1													
		X2C	The terminal strips X2C and X2D are internally parallel connected. Thus, each terminal strip can be used as input or output. Based on the power supply unit the error chain contains two channels and can supply maximally 64 axis modules.											
		X2D			Status channel 1: <table border="1" style="margin-left: 20px;"> <tr> <td>OK</td> <td>=</td> <td>$U > 9V$</td> </tr> <tr> <td>Error</td> <td>=</td> <td>$U < 5V$</td> </tr> </table> Status channel 2: <table border="1" style="margin-left: 20px;"> <tr> <td>Release axis modules</td> <td>=</td> <td>$U < 5V$</td> </tr> <tr> <td>no release axis modules</td> <td>=</td> <td>$U > 9V$</td> </tr> </table>	OK	=	$U > 9V$	Error	=	$U < 5V$	Release axis modules	=	$U < 5V$
OK	=	$U > 9V$												
Error	=	$U < 5V$												
Release axis modules	=	$U < 5V$												
no release axis modules	=	$U > 9V$												

Figure 31: Error chain terminal X2C, X2D

4.3.1.1 Error chain (channel 1)

The first error channel is an error chain. If there is an error in a module, the other modules can be notified of the error directly via this channel. The response to the error can be parameterized.

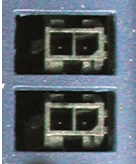
4.3.1.2 Error power supply unit (channel 2)

At this error channel the axis modules get the information that the power supply unit is in error status and the modulation of all axis modules must be switched off.

4.3.1.3 Wiring example error chain

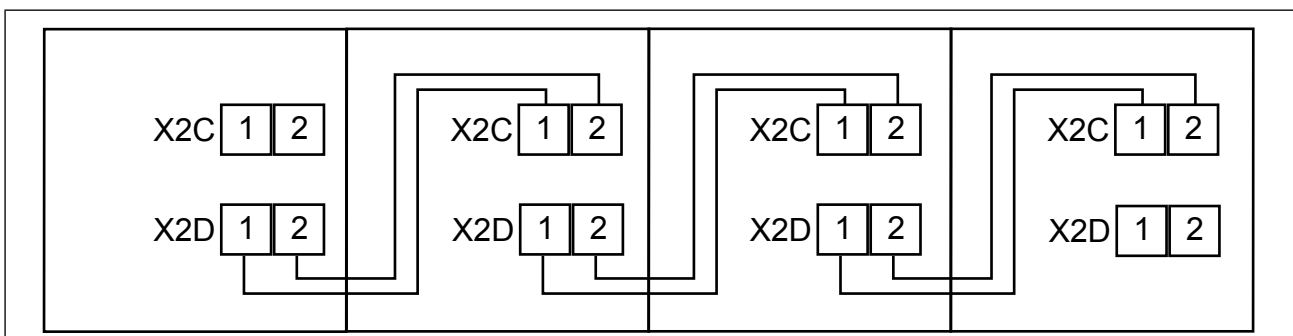

Figure 32: Wiring example error chain

4.3.2 EtherCat system bus terminal X4B

The EtherCAT system bus serves for the communication of the master with the axis modules and the power supply and regenerative unit. „CanOpen over EtherCAT “ is used as protocol. Upto eight axes can be operated isochron with a cycle time of <250 µs.

Description of the LEDs		RJ45 socket		Assignment	
LED green	Link		X4C EtherCAT OUT	1	TX+
off	Connection off			2	TX-
flashing	Communication			3	RX+
on	Connection on			4	–
				5	–
LED yellow	Speed		X4B EtherCAT IN	6	RX-
off	10 MBit			7	–
on	100 Mbit			8	–

Table 17: EtherCat System bus socket X4B

4.3.3 Diagnosis/visualisation X4A

The integrated RS232/485 interface serves for the connection of service tools (e.g. COMBIVIS) and displays. Telegram DIN66019II is used as communication protocol.

Interface	Standard	Connecting cable
RS485	TIA/EIA-485 and ISO 8482	–
RS232	ANSI TIA/EIA-232	0058025-001D and if necessary USB serial converter

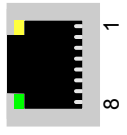
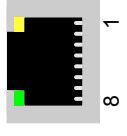
Table 18: Diagnosis/visualisation X4A

NOTICE

Defect with wrong potential!

Destruction of the interface!

The diagnostic interface is not electrically isolated, it has the same potential as control potential.

4.3.4 Digital inputs and outputs X2A

Additionally to the central inputs and outputs of the control unit each axis module is equipped with own inputs and outputs. Terminal block X2A includes four digital inputs and four digital outputs with the appropriate mass terminals.

4.3.4.1 Technical data of the inputs

The digital inputs are specified in accordance with IEC61131-2 type 3.

Status „0“	Status „1“
-3...5V	11...30V

4.3.4.2 Technical data of the outputs

The digital outputs are short-circuit proof and specified in accordance with IEC61131-2.

Technical Data		
Max. switching voltage	U / V	30
Max. current	I / A	0.7 (per output) 1 (total current for all outputs)
Internal resistance	R / Ω	250
Max. switching frequency	f / kHz	1
Inductive load	L / mJ	max. 300 (without free-wheeling diode)

Table 19: Technical data of the digital output

4.3.4.3 Assignment of the interfaces

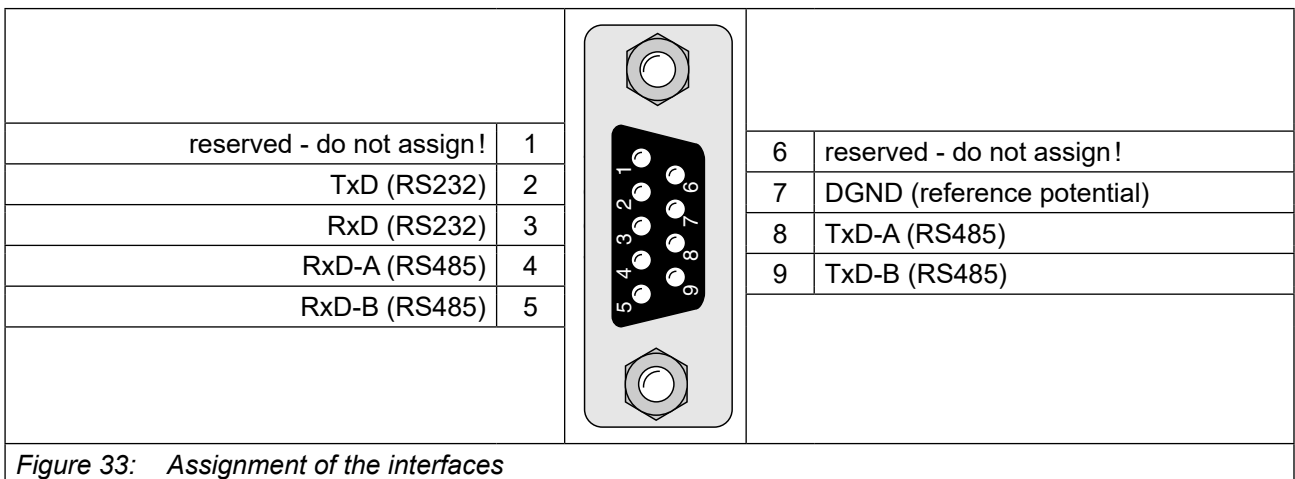

4.3.5 Assembly of the wires to PUSH IN terminals

NOTICE

Malfunctions caused by loose cable connections!

- ▶ Observe metal sleeve length and stripping length
- ▶ When using shorter wire-end ferrules, reliable contacting cannot be guaranteed

Cross-section	Wire-end ferrule	Metal sleeve length	Stripping length
0.50 mm ²	with plastic collars (DIN 46228-4)	10 mm	12 mm
0.75 mm ²		12 mm	14 mm
1.00 mm ²		12 mm	15 mm
1.50 mm ²	without plastic collars (DIN 46228-1)	10 mm	10 mm
0.2...1.5 mm ² single-wire or fine-wire	without wire-end ferrule	–	10...12 mm

Table 20: Wire-end ferrules and stripping length



KEB generally recommends the use of wire-end ferrules in industrial environments.

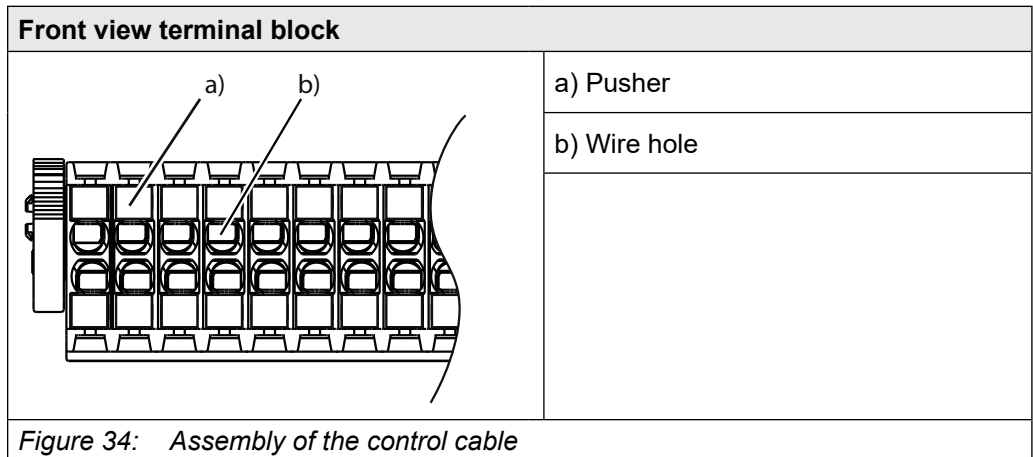

- Press pusher by hand. Insert connecting wires into the respective hole, that no single wires can be seen from the outside or bend outward. A first resistance must be overcome when inserting. Release the pusher.
- The connecting wire can also be inserted without pressing the pusher in case of cross-sections from 1 mm².
- Check that the connecting wire is fixed and can not be pulled-out. It is important to ensure that the connecting wire and not the insulation is clamped.

4.3.5.1 Assignment of the terminal block X2A

Digital inputs and outputs				
Function	Term.		Term.	Function
Digital input DI 4	16		15	0V
Digital input DI 3	14		13	0V
Digital input DI 2	12		11	0V
Digital input DI 1	10		9	0V
Digital output DO 4	8		7	0V
Digital output DO 3	6		5	0V
Digital output DO 2	4		3	0V
Digital output DO 1	2		1	0V

Figure 35: Assignment of the terminal block X2A

4.3.5.2 Connection of the digital inputs

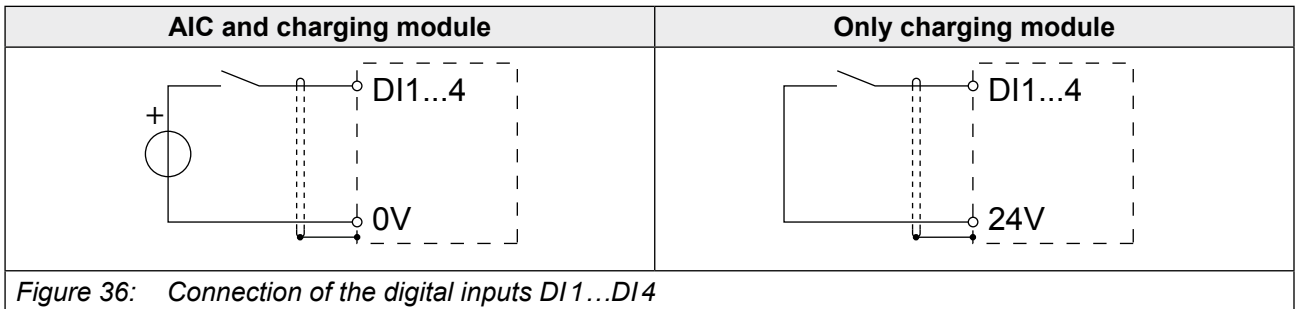

Figure 36: Connection of the digital inputs DI1...DI4

4.3.5.3 Connection of the digital outputs

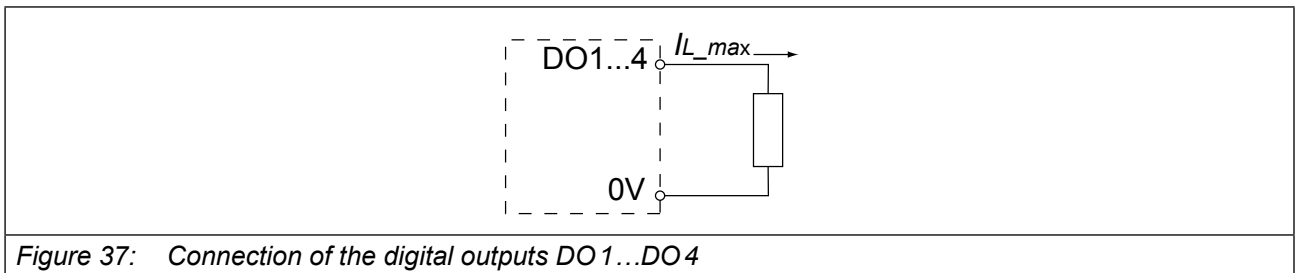

Figure 37: Connection of the digital outputs DO1...DO4

4.3.5.4 Example for the control of digital inputs and digital outputs

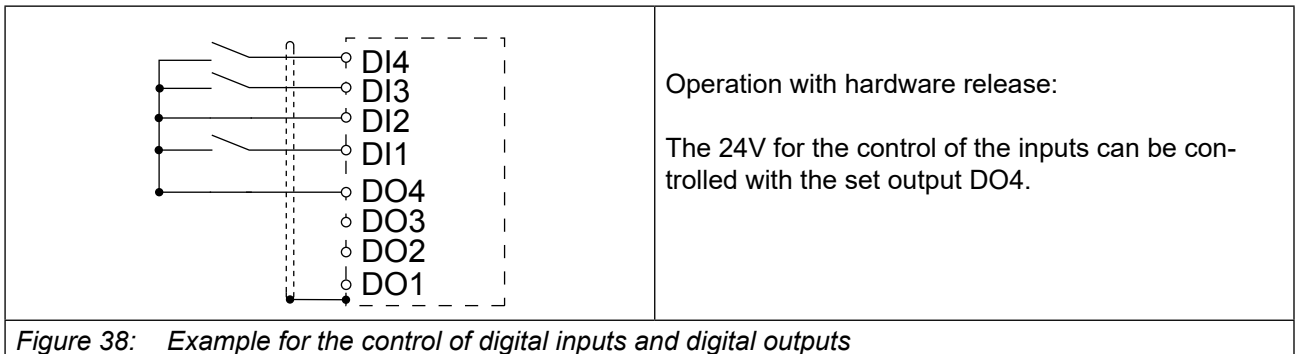

Figure 38: Example for the control of digital inputs and digital outputs

4.4 Safety module terminal block X2B

4.4.1 General instructions for safety modules

Three different modules are available in accordance with the security requirements of ISO 13849. Operation of the COMBIVERT H6 without module is not possible. The function of the single modules is specified in the following table:

Module	Function	Description
Type 0 (standard)	Without safety function	Control release and brake control, if no safety relevance is required.
Type 1	STO	Safe Torque Off (safe torque disconnection by switching off the modulation and the driver supply)
	SBC	Safe Brake Control (safe brake control)
Type 2	STO	Safe Torque Off (safe torque disconnection by switching off the modulation and the driver supply)
	SBC	Safe Brake Control (safe brake control), the function ensures safe brake engage on demand.
	SS1	Safe Stop 1 (safe stop 1); the drive is decelerated by the effect of the drive control, while the brake ramp is monitored. After reaching the idle position or after expiration of a deceleration time, state STO is set.
	SS2	Safe Stop 2 (safe stop 2); the drive is decelerated by the effect of the drive control, while the brake ramp is monitored. After reaching the idle position, state SOS is set.
	SOS	Safe Operating Stop; within this safe function the drive has stopped. The motor control remains active and resists external forces.
	SLS	Safety Limit Speed (safety limit speed); exceeding of a speed limit value is prevented by this function.
	SLP	(Safely-Limited Position); exceeding of a position limit value is prevented by this function.
	SDI	Safe Direction; the safety function monitors the direction of rotation of a drive in a defined direction.
	SLI	Safely-Limited Increment; a limited increment is monitored with this safety function.
	SSM	Safe Speed Monitor; The safety function provides a safe output signal below a specified value of a maximum drive speed.

Table 21: Safety module terminal block X2B general information



Safety manual safety module type 1
www.keb.de/fileadmin/media/Manuals/dr/ma_dr_safety-typ-1-shb-20109577_de.pdf



Safety manual safety module type 2
www.keb.de/fileadmin/media/Manuals/h6/safety/h6_safety_type2_20093648_deu.pdf



4.4.2 Module type 0 terminal block X2B

Module type 0 is used for switching the control release and brake control release if no safety requirements are made.

	Pin	Name	Description
	4	BR	Brake release
	3	0V	Mass
	2	24V	24V output ($I_N = 100 \text{ mA}$)
	1	ST	Control release
Assembly and cable cross-sections see "Assembly of the connecting wires".			
<i>Figure 39: Safety module type 0 terminal block X2B (top view)</i>			

The digital inputs are specified in accordance with IEC61131-2 type 3.

Status "0"	Status "1"
-3...5V	11...30V

4.4.2.1 Control release

The driver modules of the power modules are supplied with voltage by switching the control release.

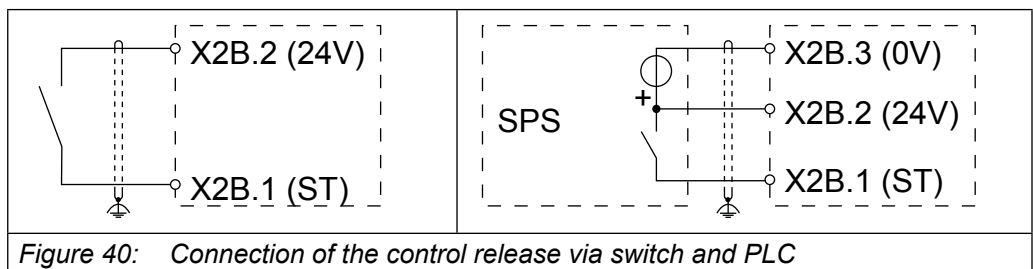

4.4.2.2 Brake control

Connections for a brake are arranged at terminal block X1B of the motor modules (respectively X1B and X1C at double axis modules). The brake release must be set in order to release the brake(s) by software. The brake release applies for both brake outputs at double axis modules.

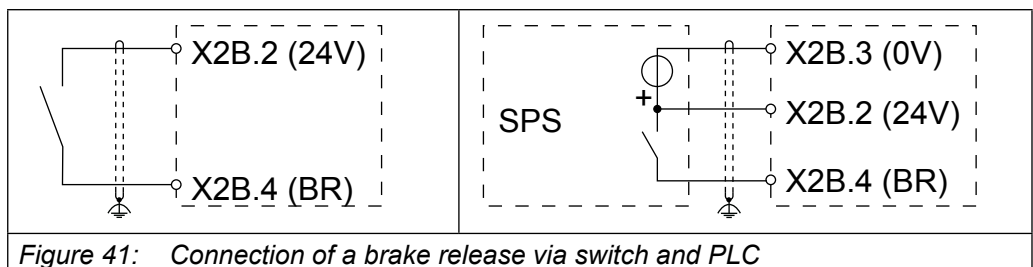

4.4.3 Module type 1 and 2

Module types 1 and 2 are described in a separate manual, since further instructions are necessary for the compliance of the safety regulations.

5 Cooling System

5.1 Installation of water-cooled units

Water-cooled drive converters are operated in continuous operation with lower temperature than air-cooled inverters. This has positive effects on lifetime-relevant components such as fan and DC link circuit capacitors and power modules (IGBT). Also the temperature dependent switching losses are positively effected. The use of water-cooled KEB COMBIVERT drive converters is offered in the drive technology, because there are process-caused coolants available with some applications. The following instructions must be observed absolutely when this units are used.

5.1.1 Heat sink and operating pressure

Design system	Material (voltage)	Max. operating pressure	Connecting duct
Extrusion casting heat sink	Aluminium (-1.67 V)	10 bar	0000650-G140

The heat sinks are sealed with sealing rings and posses a surface protection (anodized) even in the ducts.

NOTICE

Maximum operating pressure!

The heat sink is permitted for a pressure or leak test upto 2-fold, maximum operating pressure. An UL acceptance with 5-fold, maximum operating pressure was executed. Pay attention to the guidelines 97/23/EC of pressure units.

5.1.2 Materials in the cooling circuit

For the screw connections and also for the metallic articles in the cooling circuit which are in contact with the coolant (electrolyte) a material is to be selected, which forms a small voltage difference to the heat sink in order to avoid contact corrosion and/or pitting corrosion (electro-chemical voltage series, see table). An aluminum screw connection or ZnNi coated steel screw connection is recommended. Other materials must be examined in each case before employment. The specific case of application must be checked by the customer in tuning of the complete cooling circuit and must be classified according to the used materials. With hoses and seals take care that halogen-free materials are used.

A liability for occuring damages by wrongly used materials and from this resulting corrosion cannot be taken over!

Material	Generated Ion	Standard potential	Material	Generated Ion	Standard potential
Lithium	Li ⁺	-3.04 V	Cobald	Co ²⁺	-0.28 V
Potassium	K ⁺	-2.93 V	Nickel	Ni ²⁺	-0.25 V
Calcium	Ca ²⁺	-2.87 V	Tin	Sn ²⁺	-0.14 V
Sodium	Na ⁺	-2.71 V	Lead	Pb ³⁺	-0.13 V

continued on the next page

Material	Generated Ion	Standard potential	Material	Generated Ion	Standard potential
Magnesium	Mg ²⁺	-2,38V	Iron	Fe ³⁺	-0.037 V
Titan	Ti ²⁺	-1.75 V	Hydrogen	2H ⁺	0.00 V
Aluminium	Al ³⁺	-1.67 V	Copper	Cu ²⁺	0.34 V
Manganese	Mn ²⁺	-1.05 V	Carbon	C ²⁺	0.74 V
Zinc	Zn ²⁺	-0.76 V	Silver	Ag ⁺	0.80 V
Chrome	Cr ³⁺	-0.71 V	Platinum	Pt ²⁺	1.20 V
Iron	Fe ²⁺	-0.44 V	Gold	Au ³⁺	1.42 V
Cadmium	Cd ²⁺	-0.40 V	Gold	Au ⁺	1.69 V

Table 22: Electrochemical series / standard potentials against hydrogen

5.1.3 Requirements on the coolant

The requirements on the coolant are depending on the ambient conditions, as well as from the used cooling system. General requirements on the coolant:

Requirements	Description
Suspended particles	The size and the proportion of suspended particles in the cooling water should not exceed the following values: < 100 µm < 10 mg per liter.
pH-value	Aluminum is particularly corroded by lixiviums and salts. The optimal pH value for aluminum should be in the range of 7.5... 8.0.
Abrasive substances	Abrasive substances as used in abrasive (quartz sand), clogging the cooling circuit.
Copper cuttings	Copper cuttings can attach the aluminum and this leads to a galvanic corrosion. Copper should not be used together with aluminum due to electro-chemical voltage difference.
Hard water	Cooling water may not cause scale deposits or loose excretions. It should have a low total hardness (<20°dH) especially carbon hardness.
Soft water	Soft water (<7°dH) corrodes the material.
Frost protection	An appropriate antifreeze must be used for applications when the heat sink or the coolant is exposed temperatures below zero. Use only products of one manufacturer for a better compatibility with other additives.
Corrosion protection	Additives can be used as corrosion protection. In connection with frost protection the antifreeze must have a concentration of 20...25 Vol %, in order to avoid a change of the additives.

Table 23: Requirements on the coolant

5.1.3.1 Special requirements for open and half-open cooling systems:

Requirements	Description
Impurities	Mechanical impurities in half-open cooling systems can be counteracted when appropriate water filters are used.
Salt concentration	The salt content can increase through evaporation at half-open systems. Thus the water is more corrosive. Adding of fresh water and removing of process water works against.
Algae and myxobacteria	Algae and myxobacteria can arise caused by increased water temperature and contact with atmospheric oxygen. The algae and myxobacteria clog the filters and obstruct the water-flow. Biocide containing additives can avoid this. Especially at longer off periods of the cooling circuit preventive maintenance is necessary.
Organic materials	The contamination with organic materials must be kept as small as possible, because separate slime can be caused by this.

Table 24: Special requirements for open and semi-open cooling systems

NOTICE

Loss of the warranty claims!

Damages at the unit which are caused by clogged, corroded heat sinks or other obvious operating errors, leads to the loss of the warranty claims.

5.1.4 Connection to the cooling system

- Screw in connecting duct in accordance with the manual.
- The connection to the coolant must be carried out with flexible, pressure-resistant hoses and secured with clamps.
- Pay attention to flux direction and check tightness!
- The cooling flow must always be started before starting the KEB COMBIVERT.

The connection to the cooling system can occur as closed or open cooling circuit. The connection to a closed cycle cooling circuit is recommended, because the danger of contamination of coolant is very small. Preferably also a monitoring of the pH value of the coolant should be installed. Pay attention to a corresponding cable cross section at required equipotential bonding in order to avoid electro-chemical procedures.

5.1.5 Coolant temperature and moisture condensation

The inlet temperature may not exceed 40 °C. The maximum heat sink temperature is 60 °C or 80 °C depending on the power unit and overload capacity. To ensure a safe operation the coolant output temperature must be 10K below this temperature.

Due to high air humidity and high temperatures it can lead to moisture condensation. Moisture condensation is dangerous for the drive converter, because the drive converter can be destroyed through eventual occurring short-circuits.

NOTICE

Destruction of the drive converter by short circuit!

The user must guarantee that any moisture condensation is avoided!

The following dew point table is used to determine the permissible temperature differences. The table shows the coolant inlet temperature depending on ambient temperature and air humidity.

Air humidity in % \ Ambient temperature in °C	10	20	30	40	50	60	70	80	90	100
-25	-45	-40	-36	-34	-32	-30	-29	-27	-26	-25
-20	-42	-36	-32	-29	-27	-25	-24	-22	-21	-20
-15	-37	-31	-27	-24	-22	-20	-18	-16	-15	-15
-10	-34	-26	-22	-19	-17	-15	-13	-11	-11	-10
-5	-29	-22	-18	-15	-13	-11	-8	-7	-6	-5
0	-26	-19	-14	-11	-8	-6	-4	-3	-2	0
5	-23	-15	-11	-7	-5	-2	0	2	3	5
10	-19	-11	-7	-3	0	1	4	6	8	9
15	-18	-7	-3	1	4	7	9	11	13	15
20	-12	-4	1	5	9	12	14	16	18	20
25	-8	0	5	10	13	16	19	21	23	25
30	-6	3	10	14	18	21	24	26	28	30
35	-2	8	14	18	22	25	28	31	33	35
40	1	11	18	22	27	31	33	36	38	40
45	4	15	22	27	32	36	38	41	43	45
50	8	19	28	32	36	40	43	45	48	50

Table 25: Dew point table

To avoid condensation, the following options are available:

- Supply of temper coolant
- Temperature control

Further information can be found on the following link:



Info sheet Coolant Management

www.keb.de/fileadmin/media/Techinfo/dr/an/ti_dr_an-cooling-00004_en.pdf



5.1.6 Emptying the cooling circuit

If a system shall be switched off for a longer period, the cooling circuit must be drained completely. In the case of temperatures below 0°C, the cooling circuit must be blown out additionally with compressed air.

5.1.7 Coolant heating depending on power dissipation and flow rate with water

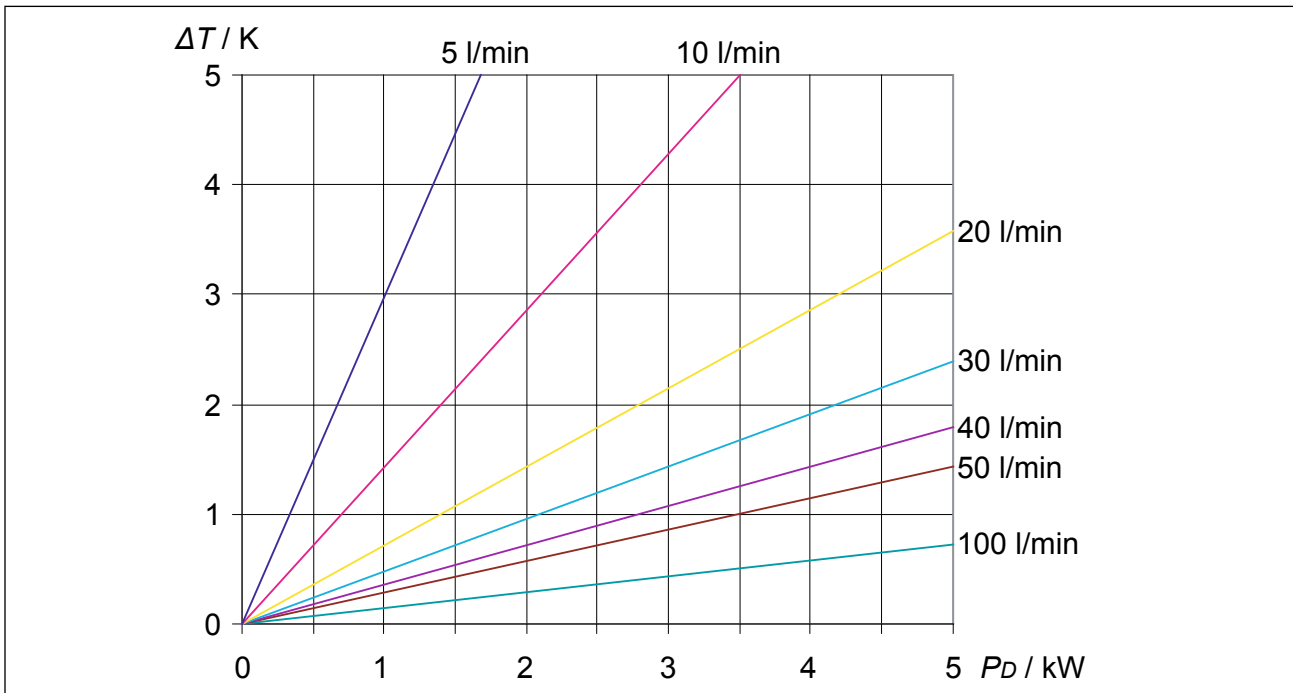

Figure 42: Coolant heating depending on power dissipation

5.1.8 Typically fall of pressure depending on the rate of flow

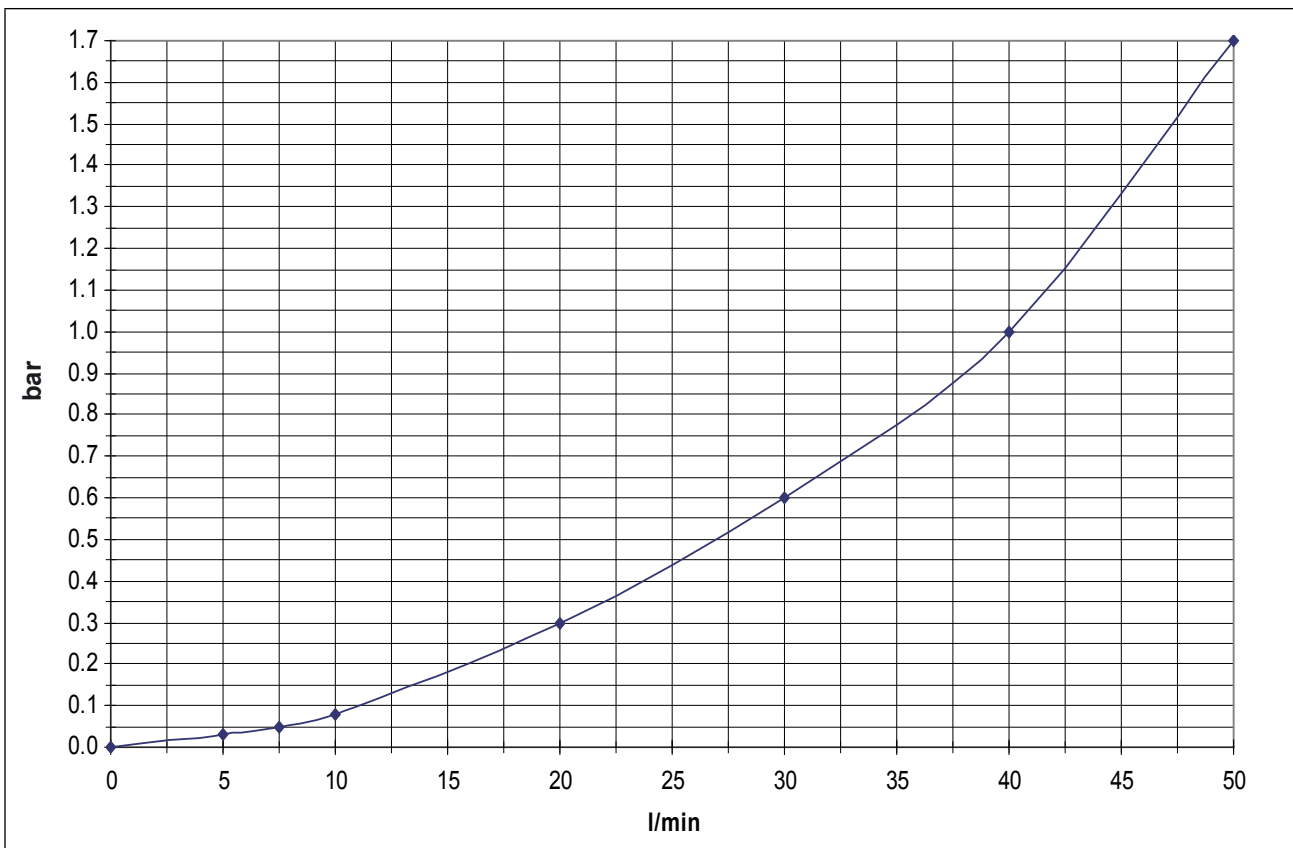

Figure 43: Typically fall of pressure depending on the rate of flow

6 Certification

6.1 CE-Marking

CE marked drive converters and servo drives were developed and manufactured to comply with the regulations of the Low-Voltage Directive and EMC Directive.

The COMBIVERT meets the requirements of the Low-Voltage Directive. The harmonised standards of the series *EN 61800-5-1* for drive controllers were used.

The COMBIVERT is a product of limited availability in accordance with *EN 61800-3*. This product may cause radio interferences in residential areas. In this case the operator may need to take corresponding measures.

Depending on the design, the machine directive, EMC directive, Low Voltage Directive and other directives and regulations must be observed.

6.2 UR-Marking

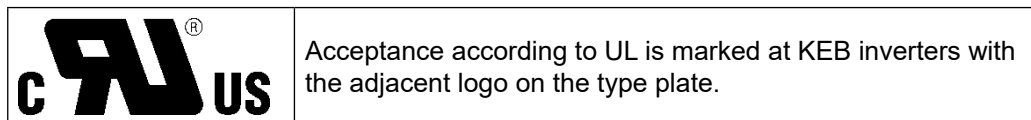

To be conform according to UL for use on the North American and Canadian Market the following additionally instructions must be observed (summary of original texts of the UL-Files):

CONDITIONS OF ACCEPTABILITY:

1. These devices shall be mounted within a suitable ultimate enclosure.
2. These devices are intended for use in a controlled environment, Pollution Degree 2 or cleaner.
3. The spacings from exposed live parts to other live parts or enclosure shall be maintained in accordance with the requirements for the end-use equipment.
4. Devices provided with Flat Rear Heat Sink are intended to be mounted with adequate Heat Sink assemblies in the end-use equipment. The cooling suitability of the devices provided with a Flat Rear Heat Sink, shall be determined in the end-use equipment by subjected Temperature Test.
5. These devices shall be used within their electrical rating.
6. The terminals on these devices are suitable for factory and field wiring.
7. These devices are evaluated for use in maximum Surrounding Air Temperature of 45°C.
8. These devices shall be provided with a wiring diagram to indicate the wiring connections.
9. These devices are evaluated for use with 60°C or 75°C copper conductors only.
10. These drive modules are only for use in combination with other supply and drive modules that are part of the Combivert H6 series.
11. Maximum heatsink temperature for all H6 drive modules shall be maintained at 80°C via a liquid cooled system.
12. Connection of an External Temperature Sensor for motor was not evaluated.

MARKING:

- Liquid cooled operating pressure

6.3 UL and UR-Marking

	<p>Acceptance according to UL is marked at KEB inverters with the adjacent logo on the type plate.</p>
---	--

To be conform according to UL for use on the North American and Canadian Market the following additionally instructions must be observed (summary of original texts of the UL-Files):

MARKING:

- Maximum surrounding air temperature for open drives.
- „Suitable For Use On A Circuit Capable Of Delivering Not More Than 18k rms Symmetrical Amperes, 480 Volts Maximum“ and „When Protected by Fuses as specified by the supply module.“
- Wiring Terminals marked to indicate proper connections for the power supply, load and control circuit.
- „Use 60/75°C Copper Conductors Only“.
- „Use in a Pollution Degree 2 environment“.
- The ground terminals are marked with „G“, „GR“, „GRD“, „Ground“, „Grounding“, „PE“, or the like, and they are distinguishable from other terminals. The symbol 5019. IEC Publication 417, may be used, but if used alone the symbol shall be defined in the installation instructions provided with the equipment.
- Power Terminals - The tightening torque Value for Field Wiring Terminals, the values (in lb-in, NM)) as specified below:

=> *„4.2 Connection of the power unit“*

- „WARNING – The opening of the branch circuit protective device may be an indication that a fault current has been interrupted. To reduce the risk of fire or electrical shock, current-carrying parts and other components of the controller should be examined and replaced if damaged. If burnout of the current element of an overload relay occurs, the complete overload relay must be replaced.“

For Canada, “DANGER”, “CAUTION” and “WARNING” markings shall be in both the English and French language.

The following French translation shall be provided:

AVERTISSEMENT

LE DÉCLENCHEMENT DU DISPOSITIF DE PROTECTION DU CIRCUIT DE DÉRIVATION PEUT ÊTRE DÙ À UNE COUPURE QUI RÉSUITE D'UN COURANT DE DÉFAUT. POUR LIMITER LE RISQUE D'INCENDIE OU DE CHOC ÉLECTRIQUE, EXAMINER LES PIÈCES PORTEUSES DE COURANT ET LES AUTRES ÉLÉMENTS DU CONTRÔLEUR ET LES REMPLACER S'ILS SONT ENDOMMAGÉS. EN CAS DE GRILLAGE DE L'ÉLÉMENT TRAVERSÉ PAR LE COURANT DANS UN RELAIS DE SURCHARGE, LE RELAIS TOUT ENTIER DOIT ÊTRE REMPLACÉ

6.4 Further informations and documentation

You find supplementary manuals and instructions for the download under www.keb.de/de/service/downloads

General instructions

- EMC and safety instructions
- Manuals for additional control boards, safety modules, fieldbus modules, etc.

Instruction and information for construction and development

- Input fuses in accordance with UL
- Programming manual for control and power unit
- Motor configurator to select the appropriate drive converter and to create downloads for parameterizing the drive converter

Approvals and approbations

- Declaration of conformity CE
- TÜV certificate
- FS certification

Others

- COMBIVIS, the software for comfortable parameterization of drive converters via PC (available per download)
- EPLAN drawings

7 Revision History

Revision	Date	Description
1C	2010-07	Manual for the axis modules in german/english completed
1D	2011-07	Link and Speed LED at the EtherCAT bus exchanged
1E	2012-04	Technical data added / changed; Chapter 3.2.1 and 3.2.2 revised; Pin assignment of the encoder interfaces changed; Pin assignment of incr.TTL and SIN/COS changed; Single axis module (only changed in German version)
1F	2012-09	H6 rectifier modules dimensioning errors and DC link capacities, H6 axis modules dimensioning errors and DC link capacities
1G	2013-09	Acquisition of the technical data of the encoder interface
1H	2014-06	Supplement capacity data, general changes, shielded connection cables for brakes, condensation time, instructions on applying the heat-conducting paste
Version	Date	Description
00	2014-10	Tolerance range of the 24V voltage changed, converted to document management
01	2015-01	Images and texts changed
02	2015-06	Editorial changes
03	2016-08	Wrong terminal, review, heat sink concepts
04	2017-05	New CI, description of brake control for double axis module, new encoder card
05	2017-09	Remove the blank pages, link InCopy modules
06	2018-03	Error correction DC bus connection
07	2019-06	Product description adapted, updates have been made
08	2020-05	Editorial changes
09	2023-02	Adaptation of the UL texts, editorial changes

Austria | KEB Automation GmbH

Ritzstraße 8 4614 Marchtrenk Austria
 Tel: +43 7243 53586-0 Fax: +43 7243 53586-21
 E-Mail: info@keb.at Internet: www.keb.at

Benelux | KEB Automation KG

Dreef 4 - box 4 1703 Dilbeek Belgium
 Tel: +32 2 447 8580
 E-Mail: info.benelux@keb.de Internet: www.keb.de

Brazil | KEB South America - Regional Manager

Rua Dr. Omar Pacheco Souza Riberio, 70
 CEP 13569-430 Portal do Sol, São Carlos Brazil
 Tel: +55 16 31161294 E-Mail: roberto.arias@keb.de

Czech Republic | KEB Automation GmbH

Videnska 188/119d 61900 Brno Czech Republic
 Tel: +420 544 212 008
 E-Mail: info@keb.cz Internet: www.keb.cz

France | Société Française KEB SASU

Z.I. de la Croix St. Nicolas 14, rue Gustave Eiffel
 94510 La Queue en Brie France
 Tel: +33 149620101 Fax: +33 145767495
 E-Mail: info@keb.fr Internet: www.keb.fr

Germany | Geared Motors

KEB Antriebstechnik GmbH
 Wildbacher Straße 5 08289 Schneeberg Germany
 Telefon +49 3772 67-0 Telefax +49 3772 67-281
 Internet: www.keb-drive.de E-Mail: info@keb-drive.de

Italy | KEB Italia S.r.l. Unipersonale

Via Newton, 2 20019 Settimo Milanese (Milano) Italia
 Tel: +39 02 3353531 Fax: +39 02 33500790
 E-Mail: info@keb.it Internet: www.keb.it

Japan | KEB Japan Ltd.

15 - 16, 2 - Chome, Takanawa Minato-ku Tokyo 108 - 0074 Japan
 Tel: +81 33 445-8515 Fax: +81 33 445-8215
 E-Mail: info@keb.jp Internet: www.keb.jp

P. R. China | KEB Power Transmission Technology (Shanghai) Co. Ltd.

No. 435 QianPu Road Chedun Town Songjiang District
 201611 Shanghai P.R. China
 Tel: +86 21 37746688 Fax: +86 21 37746600
 E-Mail: info@keb.cn Internet: www.keb.cn

Poland | KEB Automation KG

Tel: +48 60407727
 E-Mail: roman.trinczek@keb.de Internet: www.keb.de

Republic of Korea | KEB Automation KG

Deoksan-Besttel 1132 ho Sangnam-ro 37
 Seongsan-gu Changwon-si Gyeongsangnam-do Republic of Korea
 Tel: +82 55 601 5505 Fax: +82 55 601 5506
 E-Mail: jaeok.kim@keb.de Internet: www.keb.de

Spain | KEB Automation KG

c / Mitjer, Nave 8 - Pol. Ind. LA MASIA
 08798 Sant Cugat Sesgarrigues (Barcelona) Spain
 Tel: +34 93 8970268 Fax: +34 93 8992035 E-Mail: vb.espana@keb.de

Switzerland | KEB Automation AG

Witzbergstrasse 24 8330 Pfaeffikon/ZH Switzerland
 Tel: +41 43 2886060 Fax: +41 43 2886088
 E-Mail: info@keb.ch Internet: www.keb.ch

United Kingdom | KEB (UK) Ltd.

5 Morris Close Park Farm Industrial Estate
 Wellingborough, Northants, NN8 6 XF United Kingdom
 Tel: +44 1933 402220 Fax: +44 1933 400724
 E-Mail: info@keb.co.uk Internet: www.keb.co.uk

United States | KEB America, Inc

5100 Valley Industrial Blvd. South
 Shakopee, MN 55379 United States
 Tel: +1 952 2241400 Fax: +1 952 2241499
 E-Mail: info@kebameric.com Internet: www.kebameric.com



MORE KEB PARTNERS WORLDWIDE:

... www.keb.de/contact/contact-worldwide



Automation with Drive

www.keb.de

KEB Automation KG Suedstrasse 38 32683 Barntrup Tel. +49 5263 401-0 E-Mail: info@keb.de